



# Disclaimer

This user manual is provided as a free service by FixYourDLP.com. FixYourDLP is in no way responsible for the content of this manual, nor do we guarantee its accuracy. FixYourDLP does not make any claim of copyright and all copyrights remain the property of their respective owners.

About FixYourDLP.com

FixYourDLP.com (<http://www.fixyourdlp.com>) is the World's #1 resource for media product news, reviews, do-it-yourself guides, and manuals.

Informational Blog: <http://www.fixyourdlp.com>

Video Guides: <http://www.fixyourdlp.com/guides>

User Forums: <http://www.fixyourdlp.com/forum>

FixYourDLP's Fight Against Counterfeit Lamps:

<http://www.fixyourdlp.com/counterfeits>

## Sponsors:

RecycleYourLamp.org – Free lamp recycling services for used lamps:

<http://www.recycleyourlamp.org>

Lamp Research - The trusted 3rd party lamp research company:

<http://www.lampresearch.com>

Discount-Merchant.com – The worlds largest lamp distributor:

<http://www.discount-merchant.com>



**FixYourDLP.com**

Sponsored by 



## Data Projector

MODEL

# LVP-XD10U

# LVP-SD10U

### OPERATING GUIDE

Thank you very much for purchasing this DLP™ Technology Projector.

**Please read this operating guide to ensure a correct use of the device.** After reading this manual, keep it for future reference.

### Outline

This DLP™ Technology Projector can display various computer signals and NTSC/PAL/SECAM video signals.

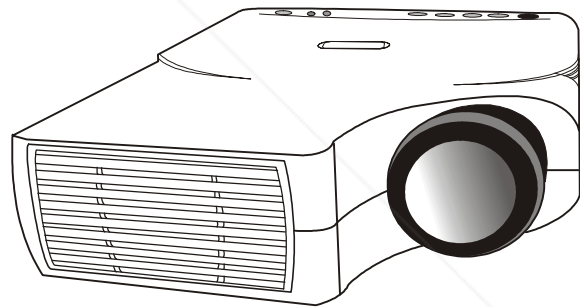

### Features

- 1. High brightness**
- 2. High resolution**
- 3. Compact size, light weight for portability**
- 4. RGB input Terminal**
- 5. Mouse Function**
- 6. Mouse Emulation**
- 7. Complies with VESA DDC1/2B specifications**



FixYourDLP.com

Sponsored by

Discount-Merchant.com (800) 281-8860

THE TRUSTED SOURCE FOR PROJECTOR LAMPS AND ACCESSORIES

## COPYRIGHT

---

Copyright © 2001 by this company. All rights reserved. No part of this publication may be reproduced, transmitted, transcribed, stored in a retrieval system or translated into any language or computer language, in any form or by any means, electronic, mechanical, magnetic, optical, chemical, manual or otherwise, without the prior written permission of this company.

## DISCLAIMER

---

This company makes no representations or warranties, either expressed or implied, with respect to the contents hereof and specifically disclaims any warranties, merchantability or fitness for any particular purpose. Further, this company reserves the right to revise this publication and to make changes from time to time in the contents hereof without obligation of this company to notify any person of such revision or changes.

## WARNING

---

Use the attached specified power supply cord. If you use another power-supply cord, it may cause interference with radio and television reception.

Use the attached VGA cable or serial mouse cable with this equipment so as to keep interference within the limit of a FCC Class B device.

This apparatus must be grounded.

## COMPLIANCE NOTICE

---

This Data Projector complies with the requirements of the EC Directive 89/336/EEC "EMC Directive" as amended by Directive 93/68/EEC and 73/23/EEC "Low Voltage Directive" as amended by Directive 93/68/EEC.

The electro-magnetic susceptibility has been chosen at a level that gains proper operation in residential areas, on business and light industrial premises and on small-scale enterprises, inside as well as outside of the buildings. All places of operation are characterized by their connection to the public low voltage power supply system.

### WARNING

**USE THE ATTACHED VGA CABLE OR SERIAL MOUSE CABLE WITH THIS EQUIPMENT SO AS TO KEEP INTERFERENCE WITHIN THE LIMITS OF A EN55022 CLASS B AND EN55013. PLEASE FOLLOW WARNINGS INSTRUCTIONS.**

## CAUTION

---

***TO PREVENT SHOCK, DO NOT OPEN THE CABINET. NO USER-SERVICEABLE PARTS INSIDE. REFER SERVICING TO QUALIFIED SERVICE PERSONNEL. AND PLEASE READ ALL OF THESE INSTRUCTIONS BEFORE YOU OPERATE YOUR PROJECTOR. SAVE THESE INSTRUCTIONS FOR FUTURE REFERENCE .***

### WARNING

**TO PREVENT FIRE OR SHOCK, DO NOT EXPOSE THIS UNIT TO RAIN OR MOISTURE, DO NOT USE THIS UNITS GROUNDED PLUG WITH AN EXTENSION CORE OR IN AN OUTLET UNLESS ALL THREE PRONGS CAN BE FULLY INSERTED.**

- For PLUGGABLE EQUIPMENT. The socket-outlet shall be installed near the equipment and shall be accessible.
- Do not stand the projector. It may fall and cause serious injury and damage to the projector.

## **SAFETY INSTRUCTIONS**

---

1. Read all of these instructions before you operate your projector and save them for future reference.
2. The lamp becomes extremely hot during operation. Allow the projector to cool for approximately 45 minutes prior to removing the lamp assembly for replacement. Do not operate the lamps beyond the rated lamp life. Excessive operation of the lamps beyond the rated life could cause them to explode on rare occasions.
3. Power is still available when the projector is in the standby mode. Never replace the lamp assembly or any electronic components unless the projector is unplugged.
4. Do not attempt to service this product yourself, as opening or removing the covers may damage the components inside and will void your warranty.
5. Do not place this product on an unstable cart, stand, or table. The product may fall, causing serious damage to the product.
6. The Standard Remote Control contains a low-power laser that acts as a pointing device during presentations. The light beam may cause injury if pointed directly into a person's eyes.
7. This product is capable of displaying inverted images for ceiling mount configurations. Please use suitable equipment for mounting the unit and make sure it is securely installed.
8. Openings in the front or at the two sides are for ventilation. They must not be blocked or covered.
9. For ventilation reasons, the fan continues to operate for about 1 minute after the projector has been powered off. Please do not unplug the power cord until the fan stops.
10. Do not look straight at the projector lens during operation. The intense light beam may injure your eyes.

### **COMPLIANCE NOTICE OF FCC**

NOTE : THIS EQUIPMENT HAS BEEN TESTED AND FOUND TO COMPLY WITH THE LIMITS FOR A CLASS B DIGITAL DEVICE, PURSUANT TO PART 15 OF THE FCC RULES. THESE LIMITS ARE DESIGNED TO PROVIDE REASONABLE PROTECTION AGAINST HARMFUL INTERFERENCE IN A RESIDENTIAL INSTALLATION. THIS EQUIPMENT GENERATES, USES AND CAN RADIATE RADIO FREQUENCY ENERGY AND, IF NOT INSTALLED AND USED IN ACCORDANCE WITH THE INSTRUCTIONS, MAY CAUSE HARMFUL INTERFERENCE TO RADIO COMMUNICATIONS. HOWEVER, THERE IS NO GUARANTEE THAT INTERFERENCE WILL NOT OCCUR IN A PARTICULAR INSTALLATION. IF THIS EQUIPMENT DOES CAUSE HARMFUL INTERFERENCE TO RADIO OR TELEVISION RECEPTION, WHICH CAN BE DETERMINED BY TURNING THE EQUIPMENT OFF AND ON, THE USER IS ENCOURAGED TO TRY TO CORRECT THE INTERFERENCE BY ONE OR MORE OF THE FOLLOWING MEASURES :

- REORIENT OR RELOCATE THE RECEIVING ANTENNA.
- INCREASE THE SEPARATION BETWEEN THE EQUIPMENT AND RECEIVER.
- CONNECT THE EQUIPMENT INTO AN OUTLET ON A CIRCUIT DIFFERENT FROM THAT TO WHICH THE RECEIVER IS CONNECTED.
- CONSULT THE DEALER OR AN EXPERIENCED RADIO/TV TECHNICIAN FOR HELP.

Changes or modifications not expressly approved by Mitsubishi could void the user's authority to operate this equipment.

### **COMPLIANCE NOTICE OF INDUSTRY CANADA**

This Class B digital apparatus complies with Canadian ICES-003.

# Table of Contents

---

<b>Introduction .....</b>	<b>1</b>
Projector Features.....	1
Description .....	2
A FRONT (FIGURE) .....	2
B REAR (FIGURE).....	2
C BOTTOM (FIGURE) .....	3
Installation .....	3
A POSITIONING.....	3
B ADJUSTABLE FEET .....	4
Moving the Projector .....	4
Accessories.....	5
<b>Connection .....</b>	<b>6</b>
A CONNECTING THE PROJECTOR TO COMPUTER/NOTEBOOK .....	6
<b>Operation .....</b>	<b>7</b>
Turn On/Off Procedure.....	7
A POWER ON .....	7
B STANDBY .....	7
External Control .....	7
A CONTROL PAD.....	7
B REMOTE CONTROL .....	9
INSERTING BATTERIES IN THE REMOTE CONTROL.....	10
Usage and Replacement of Lamp.....	11
A LAMP/TEMPERATURE STATUS LED INDICATOR .....	11
B REPLACING THE LAMP .....	13
OSD .....	15
A DISPLAY PAGE.....	16
B IMAGE PAGE .....	17
C CONTROL PAGE.....	18
D SOURCE PAGE .....	19
Other Correspondent Remote Functions and Messages .....	20
<b>Maintenance and Troubleshooting.....</b>	<b>21</b>
A LAMP REPLACEMENT.....	21
B CLEANING THE LENS .....	21
C TROUBLESHOOTING .....	22
<b>Specifications.....</b>	<b>23</b>
A OPTICAL.....	23
B ELECTRICAL.....	23
C MECHANICAL .....	23
D PRESET DISPLAY RESOLUTION TABLE.....	23
APPENDIX .....	24
FEATURES AND CONNECTION .....	24

## Projector Features

### A Image Resolution

Fully compatible with true SVGA (LVP-SD10U)/XGA (LVP-XD10U) and supports SXGA using advanced intelligent compression technology. The advanced intelligent compression technology enables it to present clear compression SVGA/XGA images without line omission.

### B Brightness

Provides superior brightness using TI's Digital Micromirror Device (DMD) and our own optical design, with a geometric effect that increases light usage efficiency. By increasing the light usage efficiency we can better reproduce the three basic colors (RGB) required for color reproduction on a single DMD.

### C Portability

This projector has a sophisticated shape, like that of an attached case, with a retractable carrying handle that is extremely compact and lightweight. It helps you make powerful presentations wherever you go with its 5-pound weight and B5 size.

### D Keystone

The projection position is already set to the height of the line of vision; there is no keystone effect. Even when projecting above or under the height of the line of vision, image distortion (if any) can be adjusted using the hotkey "KEYSTONE" correction function.

### E Multilanguage

The OSD (On Screen Display: information screens and menus) in 7 languages (English, French, Dutch, Italian, German, Spanish and Simplified Chinese.) provides you with additional information to help you make corrections with OSD operation in your native languages.

### F Auto Detect System

This projector can detect display signals from PCs with frequently used timing automatically, or use the hotkey "AUTO" to do the optimization simultaneously. It does not require complicated adjustments in order to project picture images from PCs.

### G Ceiling Mount and Rear Screen Projection

The projector is equipped with a full mirror scan conversion function (vertical/horizontal mirror), which allows the image to be reversed for ceiling mounting as well as for rear projection applications.

## H AV box (Model name: VA-10U)

An AV box is optional, and users can attach one or two to the projector. Additionally, our AV box video standard is compatible with:

NTSC	U.S. and Canada standard
PAL	Western Europe standard
SECAM	France and Eastern Europe standard
NTSC4.43	Middle East standard

If users want to watch CATV, an AV box will serve the need.

## Description

### A FRONT (figure)

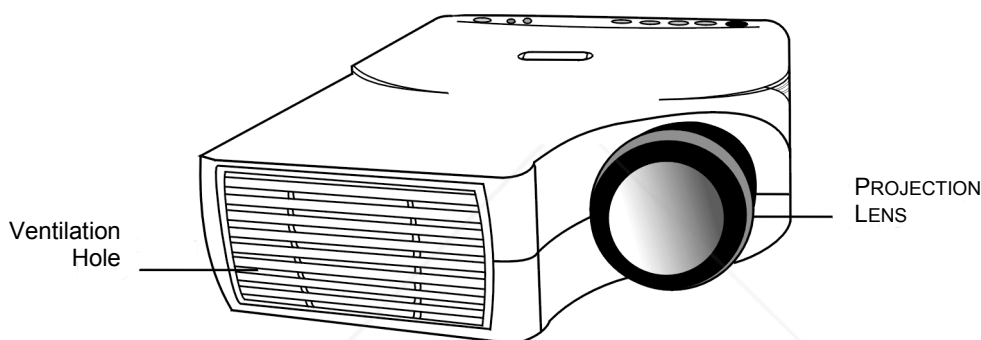

Figure 1 Front view

### B REAR (figure)

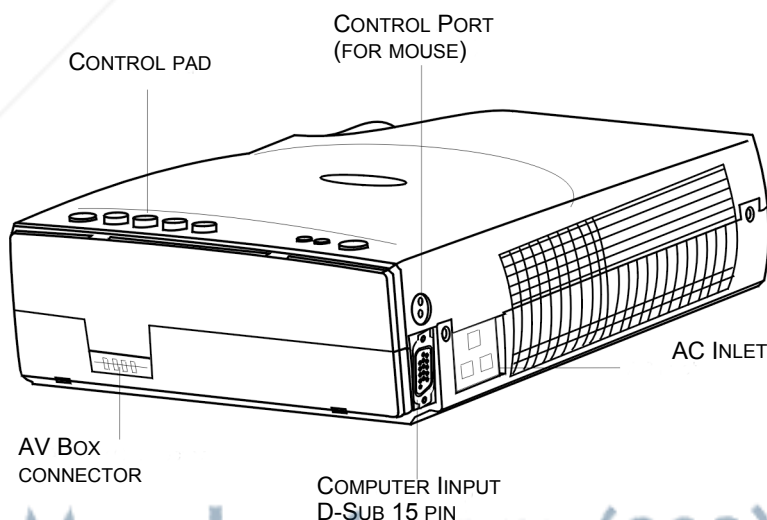

Figure 2 Rear view

## C BOTTOM (figure)

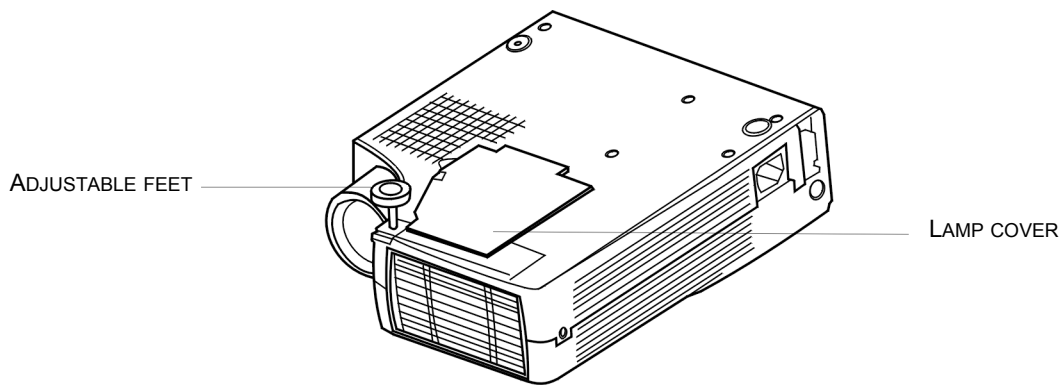

Figure 3 Bottom view

## Installation

### A Positioning

- This projector is basically designed to project on a flat projection surface. It can focus from 1.5m-12m and adjust the screen size like figure below.

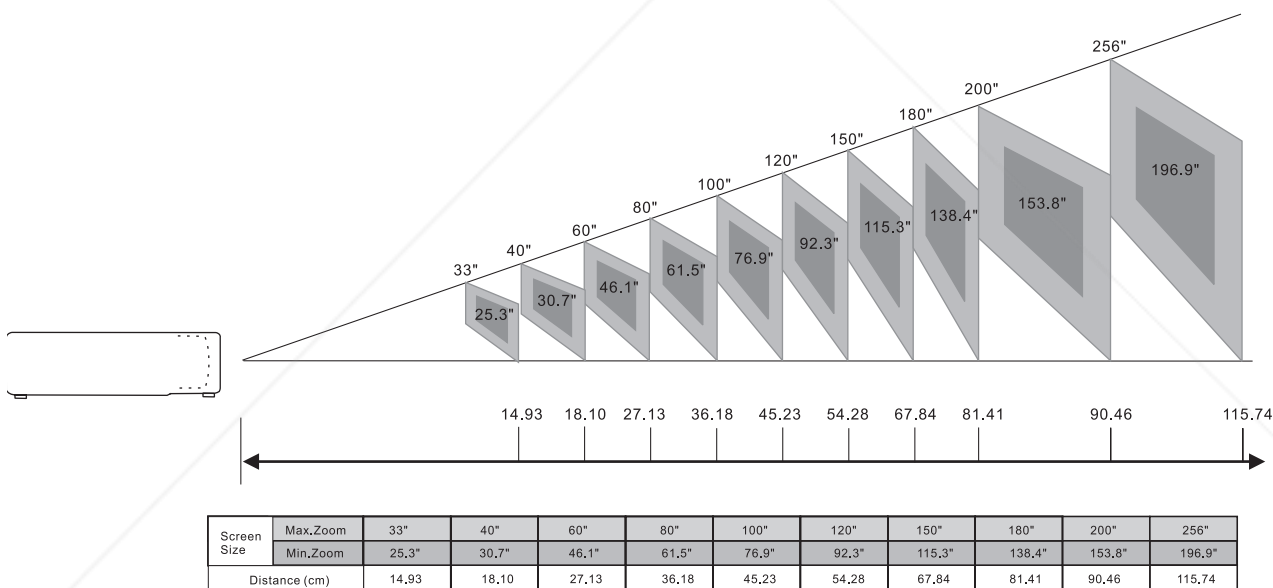

Figure 4 Positioning



## B Adjustable Feet

Picture tilt and projection angle can be adjusted by twisting Adjustable Feet. Projection angle can be adjusted 2° to 8.5° degrees by rotating the front/center foot. The projector is also equipped with left adjustable foot.

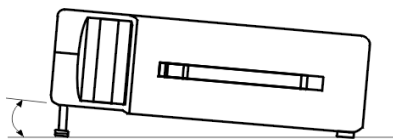

Figure 5 Adjustable feet (left/ right/ middle)

## Moving the Projector

Use the carrying handle when moving the projector.

Replace the lens cover and rotate the feet fully clockwise (to shorten the feet) when moving the projector to prevent damage to the projector.

### **Caution**

*The carrier bag (supplied) is intended to protect the projector from dust and scratches on the surface of the cabinet. It is not designed to protect the projector from external shock.*

*Do not transport the projector in an unsuitable transport case by using a courier or transport service. This may cause damage to the projector.*

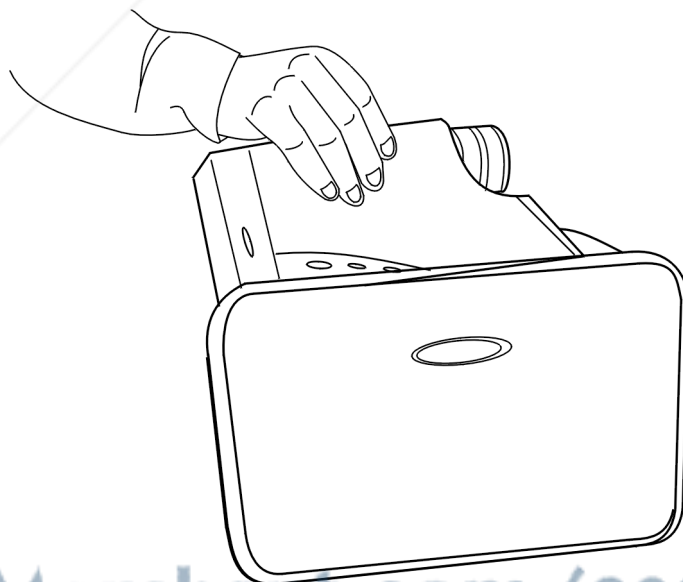

# Accessories

Please check and make sure your box contains everything listed below. If any pieces are missing, contact your dealer.

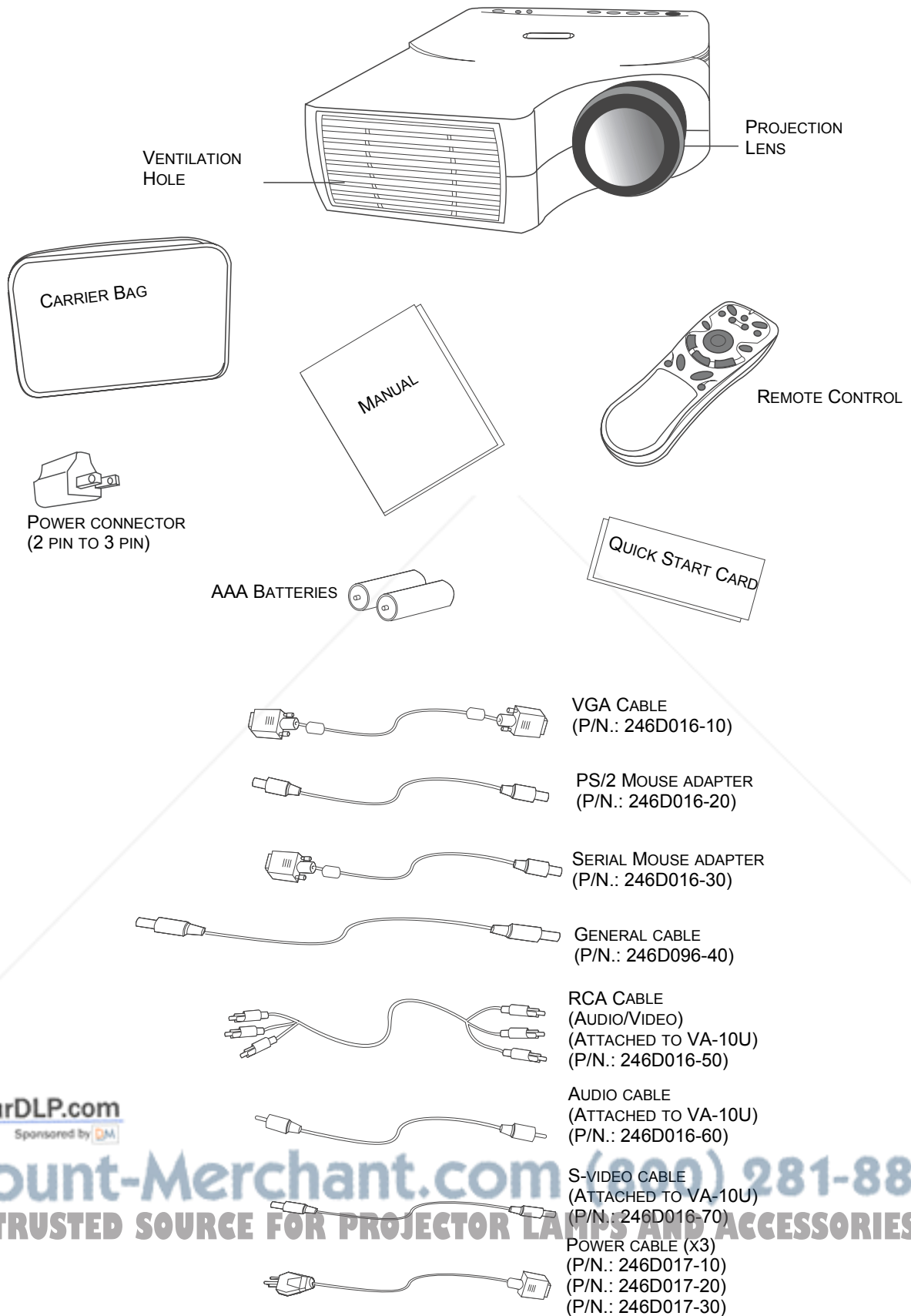

Figure 7 Accessories

## A Connecting the Projector to Computer/Notebook

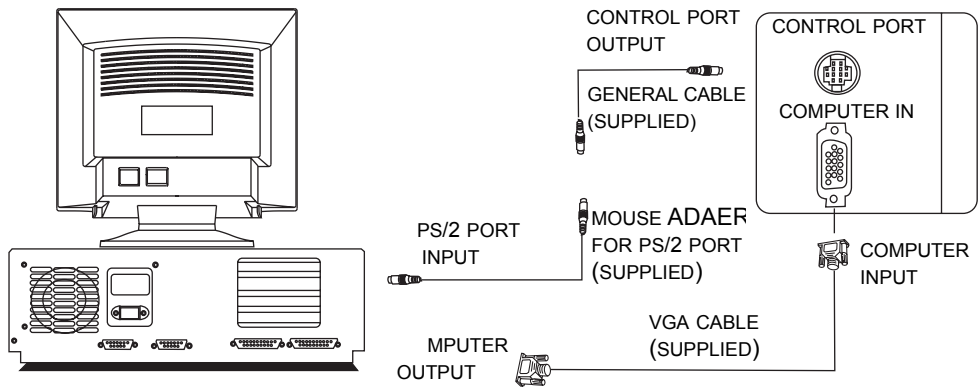

Figure 8 Connection to PC

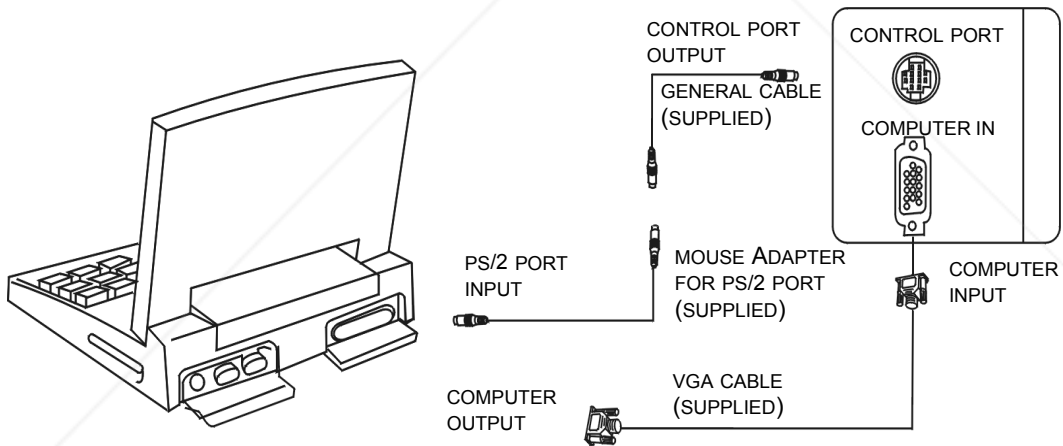

Figure 9 Connection to notebook

## Turn On/Off Procedure

### A Power on

Press the Standby/On key for 2 seconds to turn on the lamp. The LED will blink orange during the warm up and will then light solid green.

- "INPUT SIGNAL DETECTED, ACTIVATING AUTO IMAGE" will be displayed on the screen after the projector has identified the input signal;
- "SEARCHING" message will be displayed on the screen if there is no signal input;
- "SYNC IS OUT OF RANGE" message will be displayed on the screen if the horizontal frequency of the input signal exceeds the range of the projector.

### B Standby

Press the Standby/On key for 2 seconds to turn off the lamp. The LED will then blink green and the lamp will shut down, but the fan will continue to run for about 1 minute to cool the lamp. After the fan stops, the LED will turn to a light solid orange.

\*Lamp Protection Procedure: If you try to turn on the lamp again while the LED is blinking, the projector will ignore the command until it has cooled down for one minute.

## External Control

### A Control Pad Hotkey

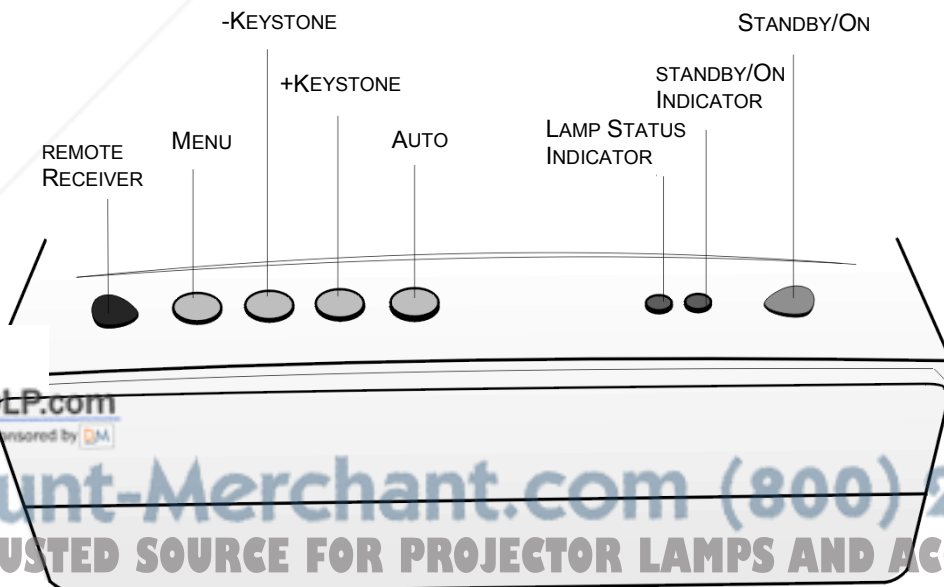

Figure 10 Hotkey control pad

MAIN UNIT	FUNCTION
<b>Auto</b>	To correct the size and phase of the projected image automatically.
<b>Keystone +</b>	To correct the upper distortion of the projected image when keystone occurs.
<b>Keystone -</b>	To correct the lower distortion of the projected image when keystone occurs.
<b>Menu</b>	To call the OSD menu.
<b>Standby/On</b>	To turn the projection lamp on and off.
<b>Standby/On indicator</b>	Functions as an indicator showing the standby status.
<b>Lamp status indicator</b>	Lights or blinks when the lamp does not light.

### Menu operating

When you press MENU button into OSD menu, all hotkeys become menu operating buttons.

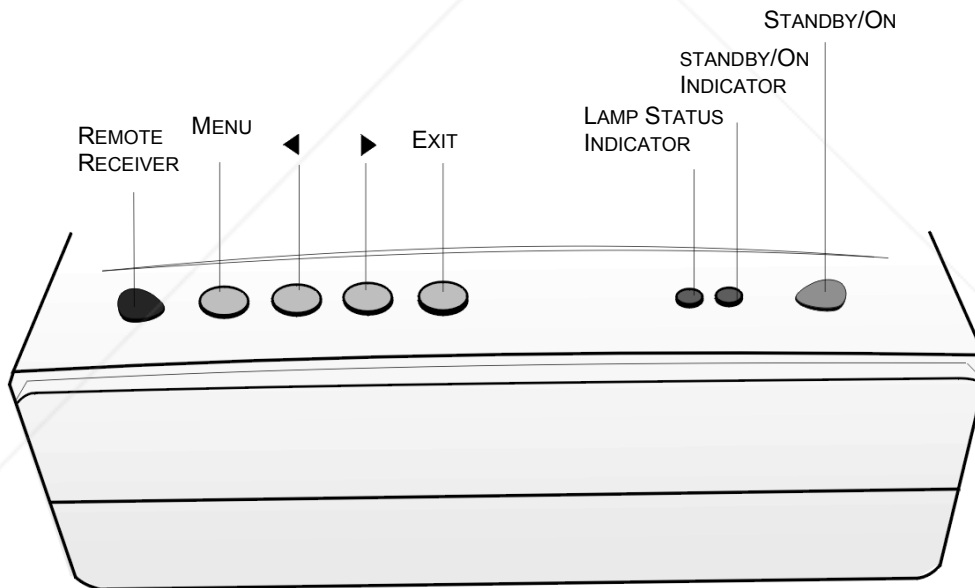
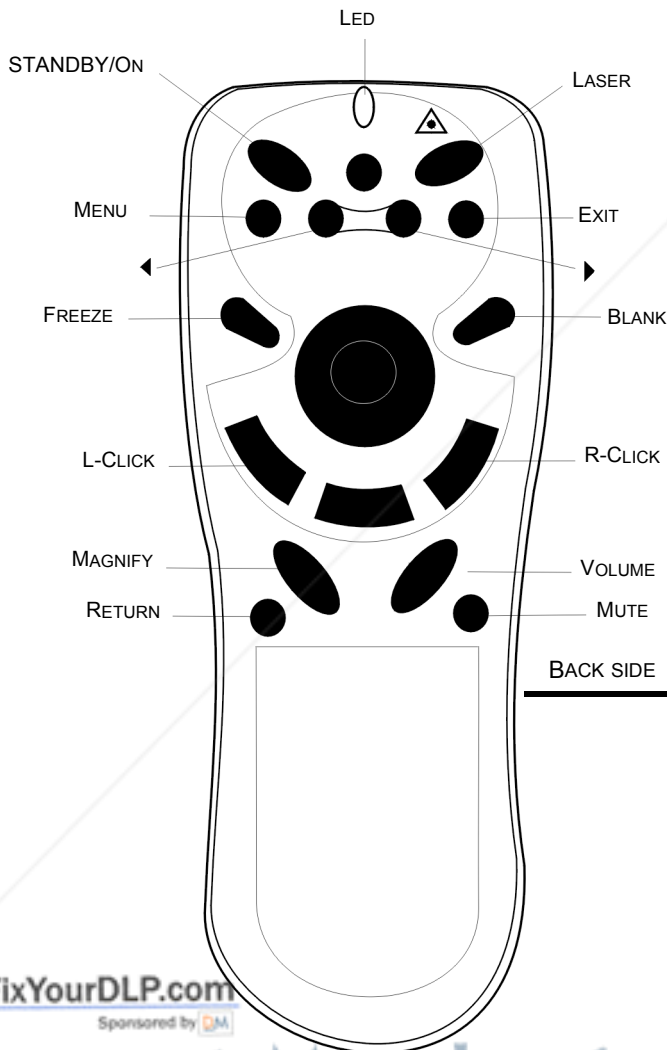

Figure 11 Menu control pad

MAIN UNIT	FUNCTION
Menu	To correct the upper distortion of the projected image when keystone occurs.
▶ (Keystone +)	To navigate through sub-pages or to increase the scale bar number.
◀ (Keystone -)	To navigate through sub-pages or to decrease the scale bar number.
Exit (Auto)	To exit from the current page or OSD menu, and save setting changes.

## B Remote Control



### About laser beam

This remote control is class 2 (max. output 1 mW laser diode 640 - 660 nm) laser equipment.

Beam Divergence : 3m distance about 5.0mm x 3.0mm (+/- 1.5mm)

### CAUTION

**LASER RADIATION  
DO NOT STARE INTO BEAM**



WAVE LENGTH:640 - 660nm  
MAX OUTPUT: 1mW  
CLASS 2 LASER PRODUCT  
IEC 60825-1:1993+A1:1997



CAUTION :

Pressing the LASER button on the provided remote control emits a laser beam. Do not look into the beam light directly. Do not point the laser beam at people. Looking at the laser beam directly may damage to your eyesight.

The use of controls or adjustments or procedures other than those specified herein may result in hazardous radiation exposure.

The remote control allows you to operate the function keys on the projector and to emulate mouse function when the projector is connected to a computer.

Main Unit	Function
Standby/On	Turns the projection lamp on and off.
Freeze	Pressing this button displays a still (frozen) picture.
Magnify	Pressing this button partially magnifies a displayed picture. (Move the picture with the Disk Pad after pressing the Magnify button.)
Disk Pad	When the OSD menu is active, Disk Pad acts as ▲▼ selecting device. When the on-screen menus are not active, it works as mouse pad. When the magnify function is active, use disk pad to move through the picture.
Menu	To call the OSD Menu. To enter sub-pages. To select items.
Blank	The blank screen is displayed by pressing Blank. And the blank screen will be revealed partially from top to bottom by pressing Blank again.
Source	Selects the input source.
Mute	Mutes the sound.
Volume	Adjusts the volume. The sound gets louder or quieter by pressing the "+" or "-" button.
Laser	Laser-pointer-on button. Use as a stick (for indication).
Mouse Left-Click	When operating in the mouse emulation mode, it registers a left mouse click.
Mouse Right-Click	When operating in the mouse emulation mode, it registers a right mouse click.
Exit	To leave current OSD Pages.
◀ ▶ Drag	To move Left/Right among OSD items.

## Inserting Batteries in the Remote Control

Be sure to follow instructions in placing batteries into the remote control units.

- Push and slide the lid in the direction of the arrow.
- Install two 'AAA' batteries as indicated inside the battery compartment.
- Replace the lid and snap it into place.



### Caution

- Avoid excessive heat and humidity.
- Do not mix new and old or different types of batteries.

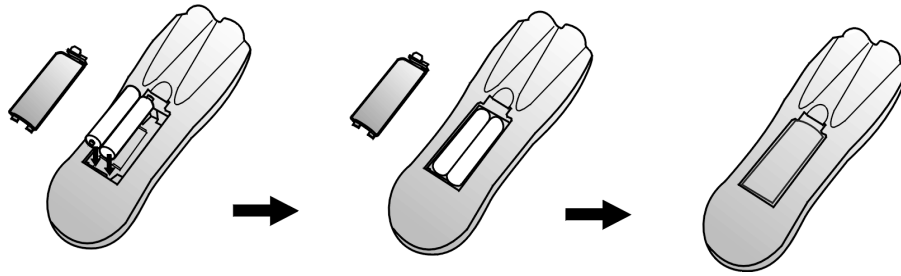

Figure 13 Battery replacement process

## Remote Control Range

The range for operation is about 10 m (about 32 feet ) when the remote control points to the projector. The distance from the screen back to the projector must be less than 10 m (about 32 feet). Depending on the type of the screen, the distance will be different.

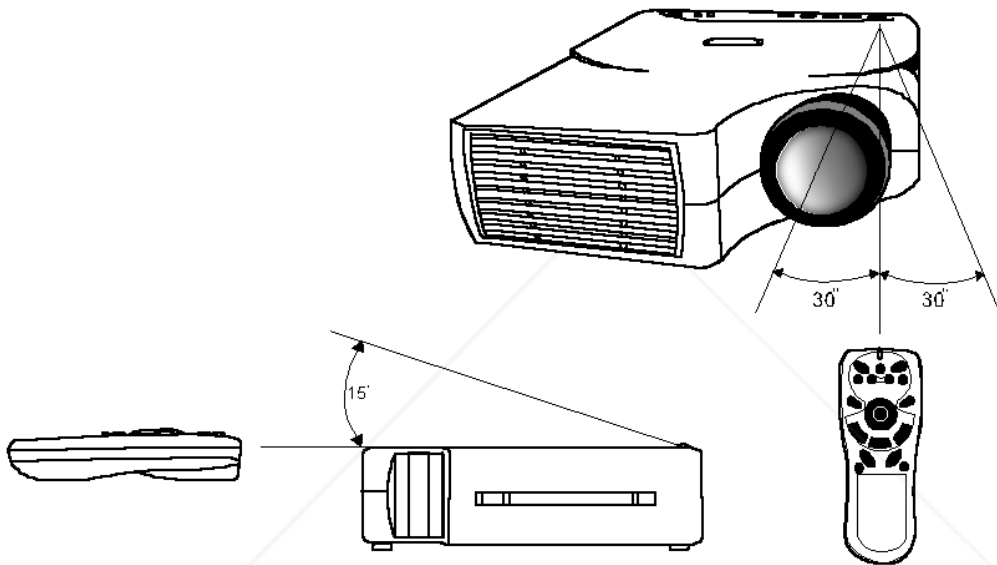

Figure 14 Range

## Usage and Replacement of Lamp

The light source lamp has a limited service life.

The picture will become dark or the color will fade after the lamp has been used for a long time. In such cases, continued use of the lamp could cause a malfunction. Replace the lamp with a new one.

### A Lamp/temperature Status LED Indicator

#### 1. Lamp in excess of service hours

When the LED light is a continuous green, it means the lamp has exceeded 900 service hours. After this light appears, it is advisable to replace the projection lamp as soon as possible.

1. "PLEASE CHANGE A NEW LAMP. AND RESET THE LAMP TIMER" will be displayed on the screen if the lamp has been operated for 900 hours (see figure 15).



2. "PLEASE CHANGE A NEW LAMP. THE POWER WILL TURN OFF AFTER 20 HOURS" will be displayed on the screen if the lamp has been operated for 980 hours. The "20" will count down (see figure 16).
3. "PLEASE CHANGE A NEW LAMP" will blink on the screen together with a green LED if the lamp has been operated for more than 1000 hours (see figure 17). The power will turn off automatically after 15 seconds. All three of the above messages will not display for more than 15 seconds, but each message will be displayed whenever you turn on the lamp.



Figure 15 Lamp replacement warning signal



Figure 16 Lamp replacement warning signal



Figure 17 Lamp replacement warning signal

## 2. Lamp is not well attached

If the LED blinks rapidly, it indicates that the lamp is not attached properly.

## 3. Temperature is too high

If the projector's internal temperature is too hot to operate safely, the LED will blink slowly for one minute and then the lamp will turn off automatically.

## 4. Normal status

If the LED light is off, it means the lamp and temperature inside the projector are normal.

FixYourDLP.com

 **Caution**

*The lamp indicator will light when the lamp becomes too hot. Turn off the power and let the projector cool for 45 minutes, then turn it on again. If the indicator is still shining, contact your dealer.*

Disc... 800-860-860

THE TRUSTED SOURCE FOR PROJECTOR LAMPS AND ACCESSORIES

## B Replacing the Lamp

### Replacing the lamp

When replacing the lamp, turn off the projector and unplug the AC cord. Wait 45 minutes so that the lamp can cool. When this high-pressure lamp is hot, it may explode if it is improperly handled.



#### Caution

- *Dispose of used lamps in accordance with local authorities.*
- *As the lamp is made of glass, do not apply shocks to it or scratch it.*
- *Also, do not use an old lamp, as this could cause the lamp to explode.*
- *If it seems that the lamp has exploded (for example, an explosive sound is heard), disconnect the power cord from the outlet and ask your dealer to replace the lamp. The lamp is covered by a front glass panel and an air-tight structure, but, in rare cases, the reflector and the inside of the projector may be damaged by scattered, broken pieces of glass, which could cause injury while being handled.*
- *For replacement lamps, please contact your dealer. (Model name: VLT-X10LP)*

### Lamp Replacement Procedure

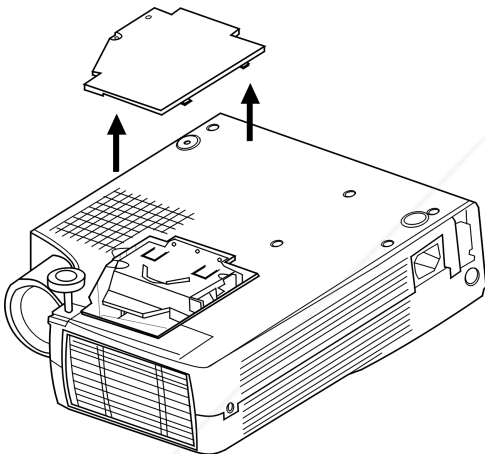

1. Turn the main power switch off and disconnect the power cord from the outlet.
2. Remove the lamp cover.
  - If hot, the lamp could cause burns. Wait for about 45 minutes until lamp has cooled down.
  - Loosen a screw and remove the cover.

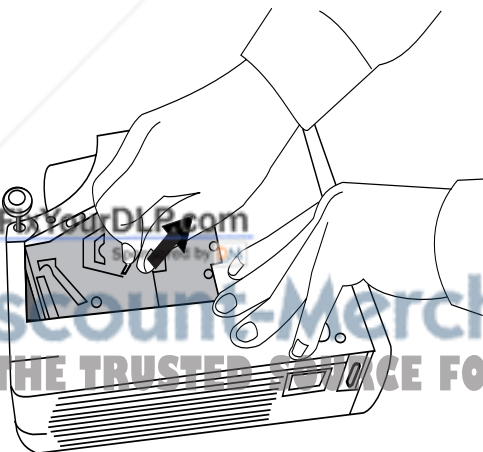

3. Loosen the 2 screws and pull the handle to remove the lamp.
  - If the screw is not loosened completely, you could hurt your fingers.
  - Do not insert your hand into the box after the lamp has been removed. (There are optical parts inside which, if touched, could result in color unevenness, etc.)

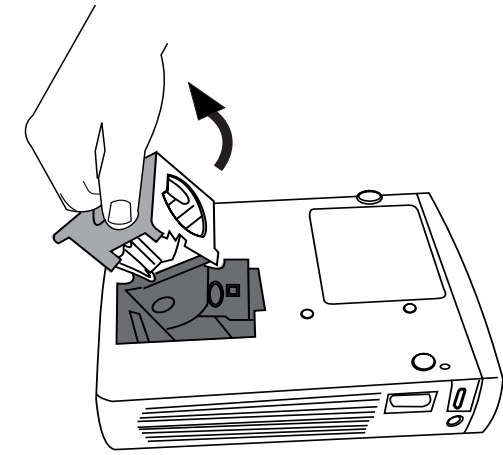

4. Replace the lamp with a new one and fix it using the same screw.
  - Firmly tighten the lamp screw. Loose screws could result in a poor connection, which could cause the unit to malfunction.

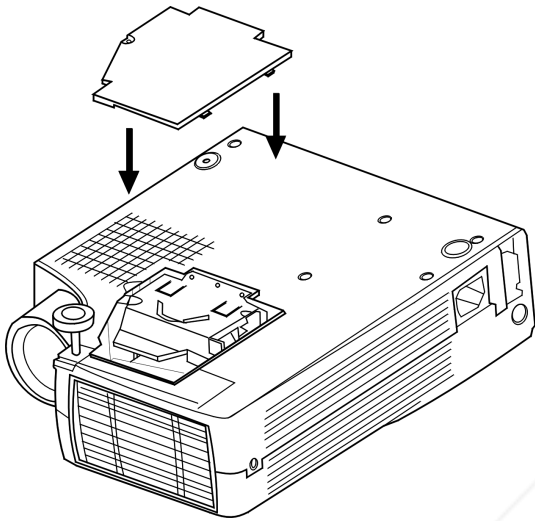

5. Install the lamp cover and fix it using a screw.
  - To prevent burns, install the lamp cover and secure it using the screw.
  - Do not turn on the power with the lamp cover removed.
  - Whenever the lamp is replaced, reset the total operation time of the lamp. Do not reset if the lamp has not been replaced.
  - Do not reset the timer without changing the lamp, as this can cause the lamp to break.

⚠ Press the lamp cover back with a few strength to make sure the cover fits to the projector without leaks.

Figure 18 Lamp replacement: Step 1, Step 2, Step 3

## Resetting Lamp Timer

If replacing the lamp before reaching 1000 hours of operation, carry out the following procedure.

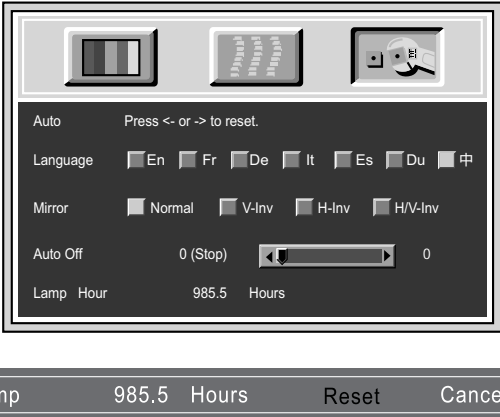
OSD	FUNCTION
	<p>Press the Standby/On button for 2 seconds to turn on the lamp.</p> <p>Press the MENU button to display the OSD menu, and use the "►" (KEYSTONE+) or "◄" (KEYSTONE-) button to select the Control page. Then press the Menu button again to highlight the Lamp item.</p> <ul style="list-style-type: none"> <li>● The MENU is not displayed when the signal is not input.</li> </ul> <p>Press the "►" (KEYSTONE+) or "◄" (KEYSTONE-) button and the lamp usage time will display on the bottom of the screen.</p> <p>Within 3 seconds, press the MENU button to reset the usage time.</p>

If replacing the lamp after 1000 hours of operations, carry out the following procedure.

OSD	FUNCTION
	<p>Press the Standby/On button for 2 seconds to turn on the lamp.</p> <p>Within 15 seconds after "AFTER 2 MINUTES, SYSTEM WILL POWER OFF" is displayed, press the MENU button twice consecutively.</p> <p>Press the Standby/On button for 2 seconds to turn off the lamp.</p>

## OSD

### Main OSD Menu

This Menu is not displayed when the signal is not input.

Press the "Menu" key and the main OSD menu structure will display as shown on the right (Fig. 19). Whenever AV box is attached, 4 sub-pages will display in the menu: Display page, Image page, Control page, and Source page. However, if the input is from a PC and no AV box is attached, Source page will not display in the menu.



Figure 19 Main OSD menu

Press the "Menu" key again to enter Display page items, or press "◄" (KEYSTONE-) or "►" (KEYSTONE+) to select the sub-pages. (The main OSD menu will automatically disappear if no key is pressed within 10 seconds).

Press the "Exit" (AUTO) button to leave the current sub-page, and press "Exit" (AUTO) the button again to leave the main OSD menu (at the same time the settings are saved).

Input status	PC input without AV box	PC input with AV box	Video input with AV box
Sub-page	Display Image Control	Display Image Control Source	Display Image Control Source

## A Display Page

When a PC is the input source, there will be only four items on this page: Keystone, Brightness, Contrast, and Color Balance (Fig. 20). On the other hand, when the input source is Video or S-video, there will be 4 other items on this page: Keystone, Brightness, Contrast, and Sharpness (Fig.21).

Press the "Menu" button again to scroll through the items; press "◀" (KEYSTONE-) or "▶" (KEYSTONE+) to adjust the item scale, or press the "Exit" (AUTO) button to go back to the main OSD page.

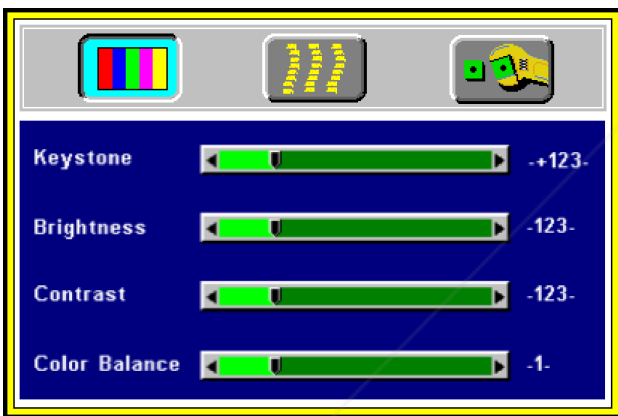

Figure 20 Display sub-page when the input source is PC (with/without AV box)



Figure 21 Display sub-page when the input source is video or s-video

Setting effects			
<b>Keystone</b>	(Decrease)	↔	(Increase) Source is PC
<b>Brightness</b>	(Dark)	↔	(Bright)
<b>Contrast</b>	(Lower)	↔	(Higher)
<b>Color Balance</b>	(Red)	↔	(Blue)
<b>Sharpness</b>	(Soft)	↔	(Sharp) Source is Video

## B Image Page

Select the Image sub-page and the first item, "Auto Resize" will be highlighted. There are five items on this page: Auto Resize, H. Phase, H. Size, H. Position, and V. Position (Fig. 22).

If an AV box is attached and the input is from Video instead of PC, another different Image sub-page including Image Ratio, System, Color and Tint will come out as seen in Figure 23.

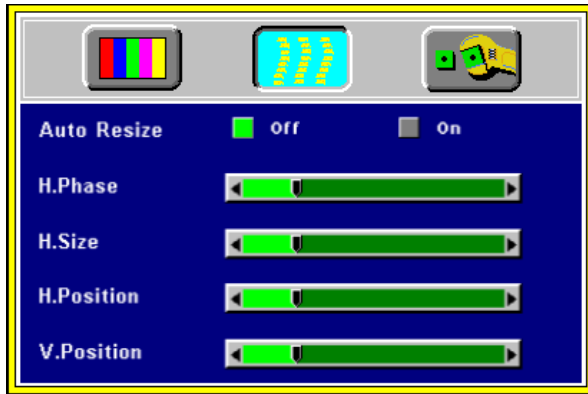

Figure 22 Image sub-page – Only available when the input signal is PC

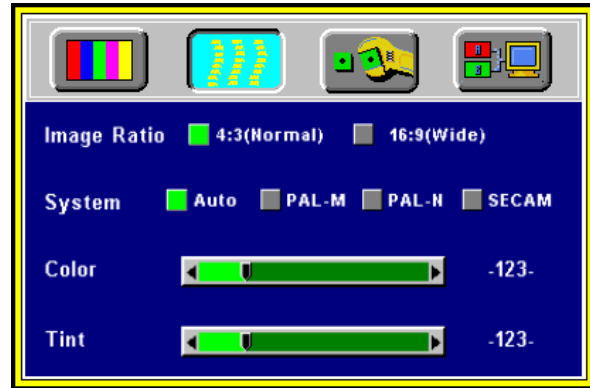
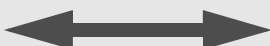
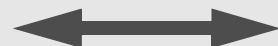
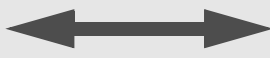
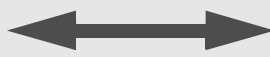

Figure 23 Image sub-page – Only available when the input signal is from video, S-video

### Setting effects

<b>Auto Resize</b>	When Auto Resize is on, the projector determines the best fit of the image to the screen.
<b>H. Phase</b>	If flicker occurs on a projected image, users may try to adjust the H. Phase manually.
<b>H. Size</b>	If the projected image is too wide or too narrow for the screen, users may turn Auto Image off and adjust the H. Size manually to fit the screen size.
<b>H. Position</b>	(move the image left)  (move the image right) The Auto Image should be turned off to activate the H. Position item. Position adjustments are saved when the projector is power off.
<b>V. Position</b>	(move the image down)  (move the image up) Position adjustments are saved when the projector is power off.

<b>Image Ratio</b>	4:3 (Normal)    16:9 (Wide)
<b>System</b>	To select the input video system standard. When an AV box is attached, the projector will automatically detect the video system. Users also can select desired video systems. When selecting system, the projector will detect the selected system simultaneously, and the OSD will still exit on the screen. The default setting for System is "Auto" (See Figure 23).
<b>Color</b>	(Less)  (More)
<b>Tint</b>	(Red)  (Green)    Source is Video or S-Video

\*Tint may not be adjusted with PAL/SECAM video signal input.

### C Control Page

When users go into the Control sub-page, the first item, "Auto" will be highlighted. There are five items on this page: Auto, Language, Mirror, Auto Off and Lamp hour (Fig. 24).



Figure 24 Control sub-page

Setting effects	
<b>Reset</b>	To reset display, image and control settings to factory settings.
<b>Language</b>	To select the OSD menu language. 7 languages are supported: English, French, Dutch, Italian, German, Spanish and Simplified Chinese. (See Figure 24).
<b>Mirror</b>	To select Normal projection, H-Invert projection, V-Invert projection, or H/V Invert projection.
<b>Auto Off</b>	To set the time to turn the power off after the start up screen is displayed and no signal is detected or sync is out of range. To select, use "◀" (Keystone-) or "▶" (Keystone+) to set the time. 0 means that the Auto Off function is inactive. *Default setting is 0 (stop).
<b>Lamp</b>	The usage time of lamp will display on this item. And you can reset the usage time of lamp from this item after you change a new lamp. ( See page 15 )

## D Source Page

This Sub-page will only show up whenever the AV box is attached.

There are five items on this page: Source, Volume, Treble, Bass, and Mute.

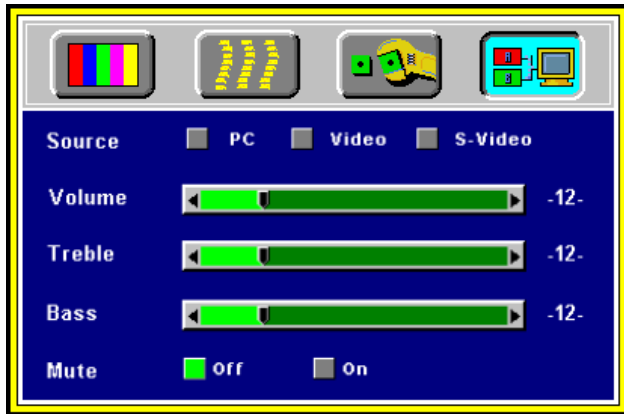

Figure 25 Source sub-page (AV box attached)









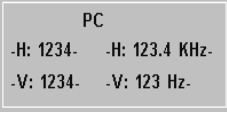

Items	Description
Source	3 input sources are available in the items when AV box is connected to the projector: PC, Video, S-video
Volume	To set the volume level of speaker built in the AV box.
Treble	To set the treble level of speaker built in the AV box.
Bass	To set the bass level of speaker built in the AV box.
Mute	To turn on/off the mute function.

\*The priority of input signal detection: (a.) PC (b.) Video (c.) S-Video

\*When selecting input sources, the projector will detect the selected input simultaneously, and the OSD menu will still exist on the screen.

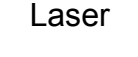

# Other Correspondent Remote Functions and Messages

OSD	FUNCTION
	<p>The selected source will be displayed at the bottom right of the screen for 3 seconds after selecting the source. (PC, VIDEO, S-VIDEO).</p>
<p>Source</p> 	
<p>Freeze</p> 	<p>The image will be frozen when the "Freeze" button is pressed. A mark appears at the lower right of the screen for 3 seconds during the freeze function. Furthermore, a "▶" mark appears at the lower right of the screen for 3 seconds when freeze is released. "Freeze" is released when the source button or the "Freeze" button is pressed again.</p>
<p>Mute</p> 	<p>Press the "Mute" button and the sound will be muted. There will be an OSD message as shown below:</p>
<p>Mute</p> 	<p>Press Mute again or the volume +/- buttons to turn off the mute.</p>
<p>Volume</p> 	<p>Press volume + or - buttons to adjust the volume. The OSD message below will appear: (The message will disappear automatically 3 seconds after the volume is adjusted.)</p>
<p>Magnify</p> 	<p>By pressing the magnify "+" button, the center of the picture can be magnified. Press the button again, and the image will be further magnified (to a maximum of 4X). Press the magnify "-" button, and the size of the magnified image will be reduced by 50 percent. To return to the normal display mode, press the "Return" button.</p>
<p>Laser</p> 	<p>Press this button to generate the laser beam.</p>
<p>Disk Pad</p> 	<p>If users connect the PS2 (ADB) mouse cable on the projector with the PC/Notebook (Macintosh/Powerbook) mouse port, the disk pad will be able to function as a PC/Notebook mouse. When an image has been magnified, press the "Disk Pad" button to move around the display area (the mouse function is not available when magnify function is on).</p>
<p>Drag</p> 	<p>This button is a toggle switch to turn on/off the drag function of the remote mouse.</p>
<p>Blank</p> 	<p>Press this button to activate or release the blank function.</p>

# Maintenance and Troubleshooting

---

## 4

### A Lamp Replacement

Refer to Page 13.

### B Cleaning the Lens

Follow these steps to clean the projection lens:

1. Apply a non-abrasive camera lens cleaner to a soft, dry cleaning cloth (abrasive cleaners, solvents or other harsh chemicals might scratch the lens).
2. Avoid using an excessive amount of cleaner.
3. Lightly wipe the clean cloth over the lens.
4. Affix the lens cover whenever the projector is not in use.



**Discount-Merchant.com (800) 281-8860**  
**THE TRUSTED SOURCE FOR PROJECTOR LAMPS AND ACCESSORIES**

## C Troubleshooting

<b>PROBLEMS</b>	<b>TRY THESE SOLUTIONS</b>
<b>NO POWER</b>	<ul style="list-style-type: none"> <li>• Plug the power cord into the AC Inlet.</li> <li>• Plug the power cord into the power Inlet.</li> <li>• Wait two minutes after the projector has been turned off before turning the projector back on.</li> </ul>
<b>NO PICTURE</b>	<ul style="list-style-type: none"> <li>• Check that you have selected the proper input source.</li> <li>• Ensure all cables are connected properly.</li> <li>• Adjust the brightness and contrast.</li> <li>• Remove the lens cap.</li> <li>• Is the POWER indicator flashing?</li> <li>• Is the STATUS Indicator flashing?</li> </ul>
<b>IMAGE ISN'T SQUARE ON THE SCREEN</b>	<ul style="list-style-type: none"> <li>• Reposition the unit to improve its angle on the screen.</li> <li>• Is the vertical offset properly corrected using the keystone function?</li> </ul>
<b>POOR COLOR</b>	<ul style="list-style-type: none"> <li>• Select the correct video system.</li> <li>• Adjust brightness, contrast, or saturation.</li> </ul>
<b>IMAGE IS BLURRED</b>	<ul style="list-style-type: none"> <li>• Adjust the focus.</li> <li>• Reposition the unit to improve its screen angle.</li> <li>• Ensure the distance between the unit and screen is within the adjustment range of the lens.</li> </ul>
<b>REMOTE CONTROL DOESN'T WORK</b>	<ul style="list-style-type: none"> <li>• Replace the batteries with new ones.</li> <li>• Make sure there is no obstacle between the remote control and the unit.</li> <li>• Stand within 10 meters (32 feet) of the unit.</li> <li>• Make sure nothing is blocking the receiver on the control pad.</li> </ul>
<b>NO SOUND</b>	<ul style="list-style-type: none"> <li>• Check audio cable connection from audio input source.</li> <li>• Adjust audio source.</li> <li>• Press "Volume" (+) button.</li> <li>• Press "Mute" button.</li> </ul>



**Discount-Merchant.com (800) 281-8860**  
**THE TRUSTED SOURCE FOR PROJECTOR LAMPS AND ACCESSORIES**

# Specifications

# 5

## A Optical

DMD	1-chip 0.7" DMDTM (Digital Micromirror Device)
Lens	Manual zoom ,manual focus (F=2.8 to 3.1 f=31 to 44)
Lamp	mercury lamp 150W
Image size	33" to 256"
Projection Distance	1.5 to 12 M

## B Electrical

Inputs	RGB (H:31.47 to 68.70 kHz V:56.25 to 85.1 Hz)
Video	(NTSC/PAL/SECAM/NTSC 4.43)
Color Reproduction	Full color, 16.7 million colors simultaneously.
Power Requirement	100 to 240 VAC, 50 to 60 Hz
Power Consumption	260 W

## C Mechanical

Dimensions	24.5 cm (L)× 6.2 cm (H)× 19.8 cm (W)
Net Weight	2.5 kg/5.5 lb.
Operational Temperature projector:	10°C to 40°C
Remote control	

## D Preset Display Resolution Table

Resolution	H Sync (kHz)	V Sync (Hz)	Remark
640x350	31.5	70.1	
640x400	37.9	85.1	VESA
640x400	31.5	70.0	
720x400	37.9	85.1	VESA
640x480	31.5	60.0	VESA
640x480	37.9	72.8	VESA
640x480	35	66.7	Macintosh
640x480	43.3	85.0	VESA
800x600	35.2	56.3	VESA
800x600	37.9	60.3	VESA
800x600	46.9	75.0	VESA
800x600	48.1	72.2	VESA
800x600	53.7	85.1	VESA
832x624	49.7	74.5	VESA
1024x768	48.4	60.0	VESA
1024x768	56.5	70.1	VESA
1024x768	60.0	75.0	VESA
1024x768	68.7	85.0	VESA
1280x1024	64.0	60.0	VESA

# Appendix

Guideline to AV box

## Features and Connection

### AV Connection Port

This box is compatible with RCA input, S-Video input, audio output.

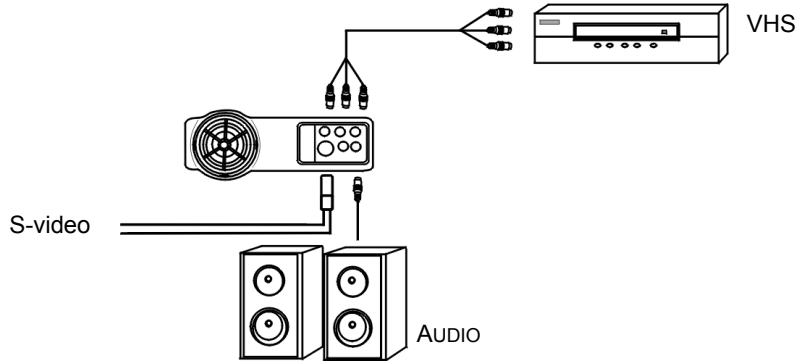

Figure 26 Connection of AV box

<b>RCA Jack</b>	For Video and Audio Input from VHS
<b>S Video Port</b>	For S-Video Input
<b>Phone Jack</b>	For Video input/Output

\*The AV box is sold separately and is not included in the standard configuration of accessories in the unit. Please contact your dealer when you need the box. (Model name: VA-10U.)

### AV Control Pad

<b>Source</b>	select the source
<b>Volume up</b>	Turn the volume upward
<b>Volume down</b>	Turn the volume downward

## Connecting the Box

Please follow the instructions here to place the AV box:

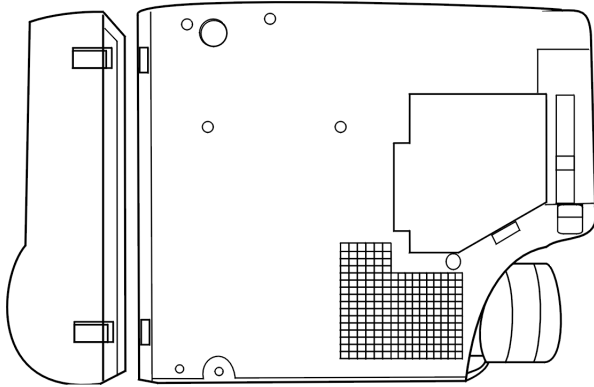

Figure 27 Bottom View of AV box

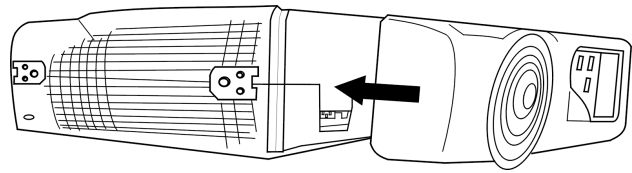
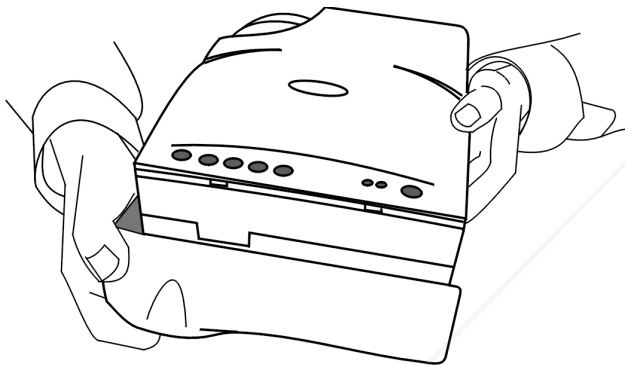

Figure 28 Side View of AV box

To attach the AV box to the unit



1. Precisely place the two chocks at the lower surface of the AV box into the lower slots in the correspondent position in the projector.

2. Slowly push the box to fit the unit and, meanwhile, insert the box plug into the A/V connector closely.

3. Plug in the correct cord into the correspondent jack or port to perform A/V function.

4. Select inputs by pressing "Source" key.

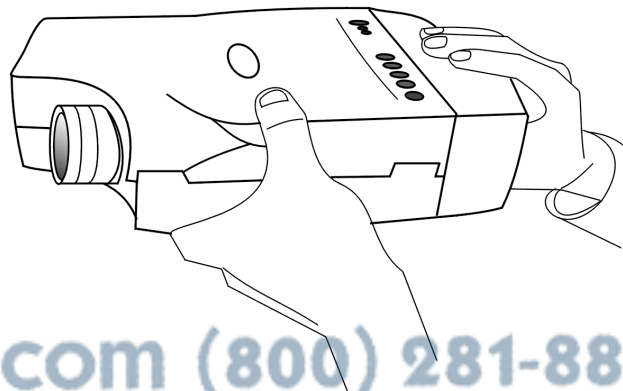
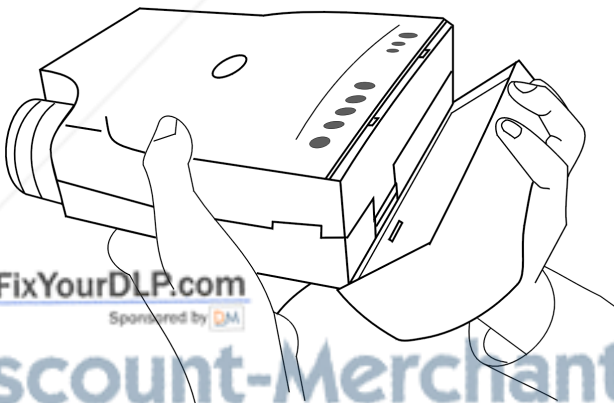

Figure 29 Connecting the Box



**Discount-Merchant.com (800) 281-8860**  
**THE TRUSTED SOURCE FOR PROJECTOR LAMPS AND ACCESSORIES**



# Disclaimer

This user manual is provided as a free service by FixYourDLP.com. FixYourDLP is in no way responsible for the content of this manual, nor do we guarantee its accuracy. FixYourDLP does not make any claim of copyright and all copyrights remain the property of their respective owners.

About FixYourDLP.com

FixYourDLP.com (<http://www.fixyourdlp.com>) is the World's #1 resource for media product news, reviews, do-it-yourself guides, and manuals.

Informational Blog: <http://www.fixyourdlp.com>

Video Guides: <http://www.fixyourdlp.com/guides>

User Forums: <http://www.fixyourdlp.com/forum>

FixYourDLP's Fight Against Counterfeit Lamps:

<http://www.fixyourdlp.com/counterfeits>

## Sponsors:

RecycleYourLamp.org – Free lamp recycling services for used lamps:

<http://www.recycleyourlamp.org>

Lamp Research - The trusted 3rd party lamp research company:

<http://www.lampresearch.com>

Discount-Merchant.com – The worlds largest lamp distributor:

<http://www.discount-merchant.com>



**FixYourDLP.com**

Sponsored by 