



Disclaimer

This user manual is provided as a free service by FixYourDLP.com. FixYourDLP is in no way responsible for the content of this manual, nor do we guarantee its accuracy. FixYourDLP does not make any claim of copyright and all copyrights remain the property of their respective owners.

About FixYourDLP.com

FixYourDLP.com (<http://www.fixyourdpl.com>) is the World's #1 resource for media product news, reviews, do-it-yourself guides, and manuals.

Informational Blog: <http://www.fixyourdpl.com>

Video Guides: <http://www.fixyourdpl.com/guides>

User Forums: <http://www.fixyourdpl.com/forum>

FixYourDLP's Fight Against Counterfeit Lamps:

<http://www.fixyourdpl.com/counterfeits>

Sponsors:

RecycleYourLamp.org – Free lamp recycling services for used lamps:

<http://www.recycleyourlamp.org>

Lamp Research - The trusted 3rd party lamp research company:

<http://www.lampresearch.com>

Discount-Merchant.com – The worlds largest lamp distributor:

<http://www.discount-merchant.com>



FixYourDLP.com

Sponsored by 

Table of Contents

Table of Contents	1
Usage Notice	2
<i>Precautions</i>	2
Introduction	4
<i>Product Features</i>	4
<i>Package Overview</i>	5
<i>Product Overview</i>	6
Main Unit	6
Control Panel	7
Connection Ports	8
Wireless Remote Control	9
Installation	10
<i>Connecting the Projector</i>	10
<i>Powering On/Off the Projector</i>	11
Powering On the Projector	11
Powering Off the projector	12
Warning Indicator	12
<i>Adjusting the Projected Image</i>	13
Adjusting the Projector Image Height	13
Adjusting the Projector Zoom / Focus	14
Adjusting Projected Image Size	14
User Controls	15
Control Panel & Remote Control	15
On-Screen Display Menus	18
How to operate	18
Menu Tree	19
Language	20
Image-I	21
Image-II (Computer Mode)	23
Image-II (Video Mode)	25
Audio	27
Management	28
Lamp Setting	31
Appendices	32
Troubleshooting	32
Replacing the lamp	36
Compatibility Modes	37
Ceiling Mount Installation	38



FixYourDLP.com
Sponsored by











Discount-Merchant.com (800) 281-8860

THE TRUSTED SOURCE FOR PROJECTOR LAMPS AND ACCESSORIES

Usage Notice

Precautions

Follow all warnings, precautions and maintenance as recommended in this user's guide to maximize the life of your unit.

-  Warning- Do not look into the projector's lens when the lamp is on. The bright light may hurt your eyes.
-  Warning- To reduce the risk of fire or electric shock, do not expose this product to rain or moisture.
-  Warning- Please do not open or disassemble the product as this may cause electric shock.
-  Warning- When changing the lamp, please allow unit to cool down, and follow all changing instructions.
-  Warning- This product will detect the life of the lamp itself. Please be sure to change the lamp when it shows warning messages.
-  Warning- Reset the "Lamp Reset" function from the On Screen Display "Lamp Setting" menu after replacing the lamp module (refer to page 31).
-  Warning- When switching the projector off, please ensure the projector completes its cooling cycle before disconnecting power.
-  Warning- Turn on the projector first and then the signal sources.
-  Warning- Do not use lens cap when projector is in operation.
-  Warning- When the lamp reaches the end of its life, it will burn out and may make a loud popping sound. If this happens, the projector will not turn back on until the lamp module has been replaced. To replace the lamp, follow the procedures listed under "Replacing the Lamp".



FixYourDLP.com
Sponsored by 

Discount-Merch.com | 1-800-833-8660
THE TRUSTED SOURCE FOR PROJECTOR LAMPS AND ACCESSORIES

Usage Notice

Do:

- ❖ Turn off the product before cleaning.
- ❖ Use a soft cloth moistened with mild detergent to clean the display housing.
- ❖ Disconnect the power plug from AC outlet if the product is not being used for a long period of time.

Don't:

- ❖ Block the slots and openings on the unit provided for ventilation.
- ❖ Use abrasive cleaners, waxes or solvents to clean the unit.
- ❖ Use under the following conditions:
 - In extremely hot, cold or humid environments.
 - In areas susceptible to excessive dust and dirt.
 - Near any appliance that generates a strong magnetic field.
 - Place in direct sunlight.



Discount-Merchant.com (800) 281-8860
THE TRUSTED SOURCE FOR PROJECTOR LAMPS AND ACCESSORIES

Introduction

Product Features

This product is an SVGA single chip 0.55" DLP™ projector. Outstanding features include:

- ◆ True SVGA, 800 x 600 addressable pixels
- ◆ Single chip Dark Chip2™ DLP™ technology
- ◆ NTSC/NTSC4.43/PAL/PAL-M/PAL-N/SECAM and HDTV compatible (480i/p, 576i/p, 720p, 1080i)
- ◆ Multi-Auto functions: Auto detection, Auto image and Auto saving the adjustments
- ◆ Full function remote control
- ◆ User friendly multilingual on screen display menu
- ◆ Advanced digital keystone correction and high quality full screen image re-scaling
- ◆ User friendly control panel
- ◆ Built-in one speaker with 2 Watt amplifier
- ◆ SXGA, XGA compression and VGA re-sizing
- ◆ Mac compatible



Discount-Merchant.com (800) 281-8860
THE TRUSTED SOURCE FOR PROJECTOR LAMPS AND ACCESSORIES

Introduction

Package Overview

This projector comes with all the items shown below. Check to make sure your unit is complete. Contact your dealer immediately if anything is missing.



Projector with lens cap



Power Cord 1.8m



VGA Cable 1.8m



Composite Video Cable
1.8m



SCART RGB/S-Video
Adaptor
(available in European
version only)



Carrying Case



❖ Due to the difference in applications for each country, some regions may have different accessories.



Wireless Remote
Controller



2 x AAA Batteries

Documents :

- User's Guide
- Quick Start Card
- Warranty Card



Discount-Merchant.com (800) 281-8860

THE TRUSTED SOURCE FOR PROJECTOR LAMPS AND ACCESSORIES

Introduction

Product Overview

Main Unit



1. Control Panel
2. Zoom Lever
3. Focus Ring
4. Power Socket
5. Elevator Foot
6. Elevator Button
7. Zoom Lens
8. IR Receivers
9. Connection Ports
10. Tilt Adjusting Feet

Introduction

Control Panel

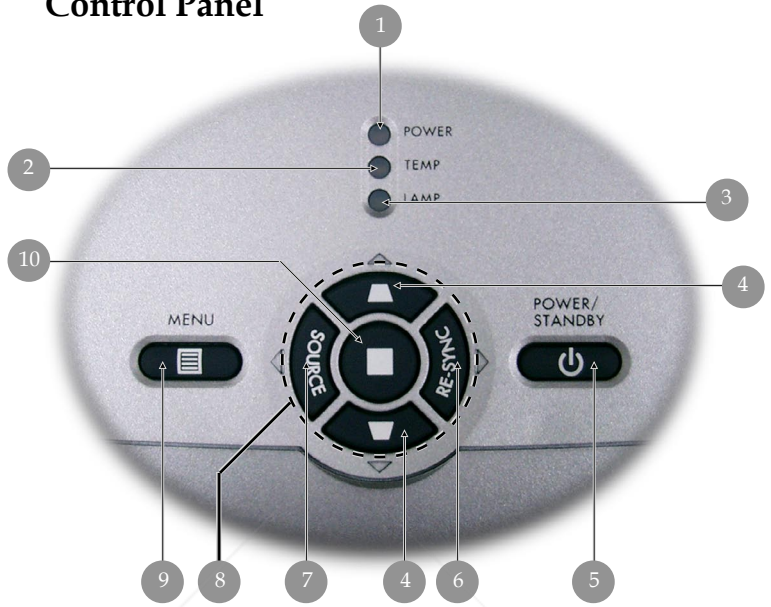

1. Power Indicator LED
2. Temp Indicator LED
3. Lamp Indicator LED
4. Keystone Correction
5. Power/Standby
6. Re-Sync
7. Source
8. Four Directional Select Keys
9. Menu (On/Off)
10. Enter

Introduction

Connection Ports

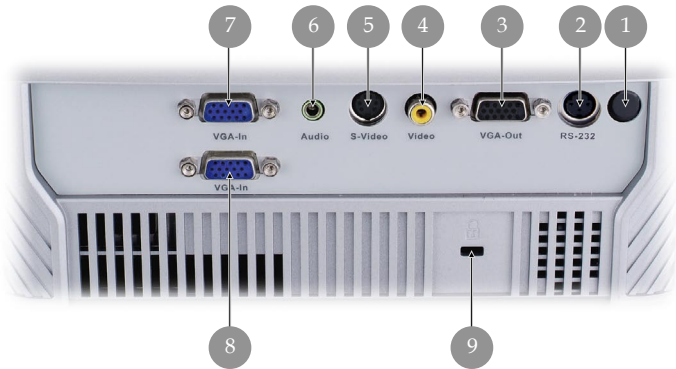

1. IR Receiver
2. RS232 Connector
3. Monitor Loop-through Output Connector
4. Composite Video Input Connector
5. S-Video Input Connector
6. Audio Input Connector
7. PC Analog signal/SCART RGB/HDTV/Component Video Input Connector
8. PC Analog signal/HDTV/Component Video Input Connector
9. Kensington™ Lock Port

Introduction

Wireless Remote Control

1. Power
2. IR LED
3. Hide
4. Freeze
5. D-Zoom
6. Display Mode
7. Menu
8. Keystone Correction
9. Re-Sync
10. Volume +
11. Volume -
12. Reset
13. Enter
14. Four Directional Select Keys
15. VGA1 Source
16. VGA2 Source
17. Composite Source
18. S-Video Source

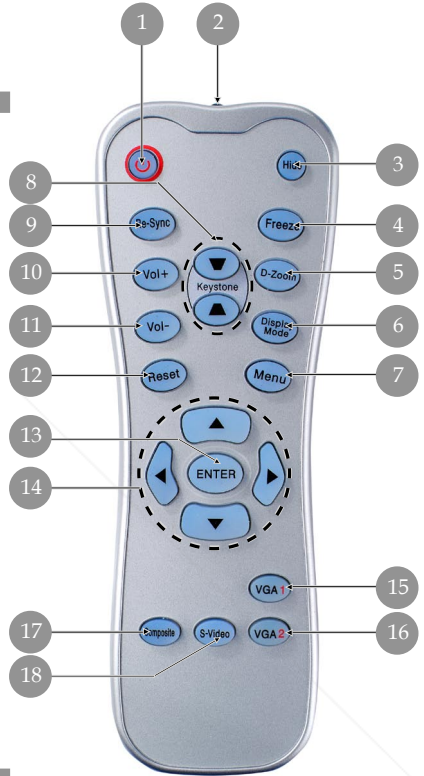

Installation

Connecting the Projector

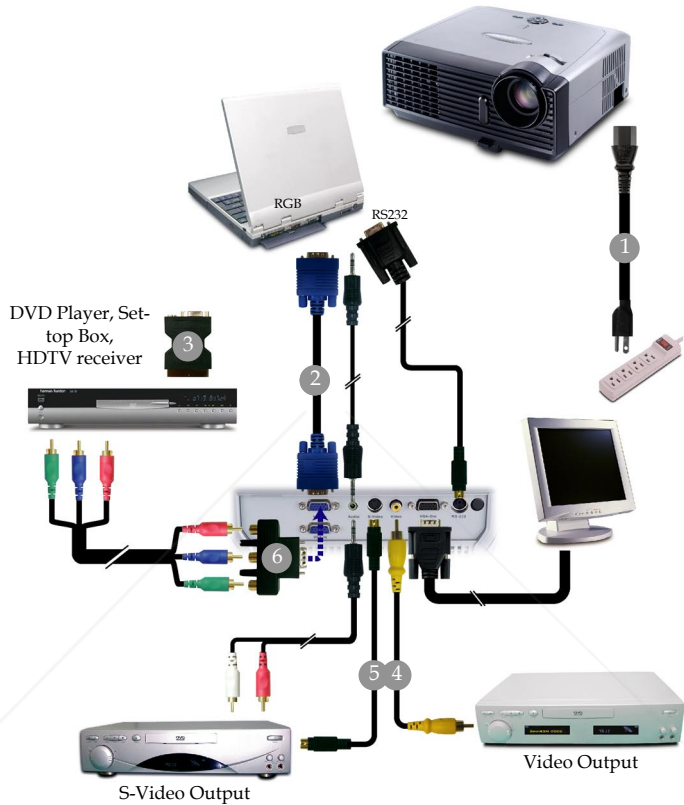

❖ Due to the difference in applications for each country, some regions may have different accessories.

1. Power Cord
2. VGA Cable
3. SCART RGB/S-Video Adaptor (For European Only)
4. Composite Video Cable
5. S-Video Cable (Optional Accessory)
6. D-15 to RCA Adapter for YPbPr (Optional Accessory)

To ensure the projector works well with your computer, please set the display mode of your graphic card less than or equal to 1280 x 1024 resolution. Make sure the timing of the display mode is compatible with the projector. Refer to the "Compatibility Modes" section on page 37.

Powering On/Off the Projector

Powering On the Projector

1. Remove the lens cap. ❶
 2. Ensure that the power cord and signal cable are securely connected. The Power LED will flash green.
 3. Turn on the lamp by pressing “Power/Standby” button on the control panel. ❷ And the Power LED will turn green. The first time you use the projector, you can select your preferred language from quick menu after the startup screen display.
 4. Turn on your source (computer, notebook, video player, etc.). The projector will detect your source automatically.
- ❖ If you connect multiple sources at the same time, use the “Source” button on the control panel or remote control to switch.

Quick Menu

Select Language

English

Deutsch

Français

Italiano

Español

Português

繁體中文

简体中文

日本語

한국어

Русский

Nederlands

Polski

Suomi

Press Enter to Set



❖ Turn on the projector first and then the signal sources.



Discount-Merch.com 281-8860
THE TRUSTED SOURCE FOR PROJECTOR LAMP AND ACCESSORIES



Installation

Powering Off the Projector

1. Press the “Power/Standby” button to turn off the projector lamp, you will see a message

Power off the lamp ?

Picture Mute

displayed on the projector’s screen. Press the “Power/Standby” button again to confirm, otherwise the message will disappear after 5 seconds.

Please note that if the ► key is pressed instead, the projector will enter the “Picture Mute” mode and no image will be displayed. To exit the “Picture Mute” mode, press the “Power/Standby” button again.

2. The cooling fans continue to operate for about 30 seconds for cooling cycle and the Power LED will turn green. When the Power LED begins flashing, the projector has entered standby mode.

If you wish to turn the projector back on, you must wait until the projector has completed the cooling cycle and has entered standby mode. Once in standby mode, simply press “Power/Standby” button to restart the projector.

3. Disconnect the power cord from the electrical outlet and the projector.
4. Do not turn on the projector immediately following a power off procedure.

Warning Indicator

- ❖ When the “LAMP” indicator lights solid red, the projector will automatically shut itself down. Please contact your local reseller or service center. See page 34~35.
- ❖ When the “TEMP” indicator lights solid red for about 60 seconds, it indicates the projector has been overheated. The projector will automatically shut itself down. Under normal conditions, the projector can be switched on again after it has cooled down. If the problem persists, you should contact your local dealer or our service center. See page 34~35.
- ❖ When the “TEMP” indicator flashes red for about 5 seconds, it indicates the fan failed. Please contact your local dealer or our service center. See page 34~35.

Installation

Adjusting the Projected Image

Adjusting the Projector Image Height

The projector is equipped with an elevator foot for adjusting the image height.

To raise the image:

1. Press the elevator button **1**.
2. Raise the image to the desired height angle **2**, then release the button to lock the elevator foot into position.
3. Use **3** to fine-tune the display angle.

To lower the image:

1. Press the elevator button.
2. Lower the image, then release the button to lock the elevator foot into position.
3. Use **3** to fine-tune the display angle.



Installation

Adjusting the Projector Zoom / Focus

You may turn the zoom lever to zoom in or out. To focus the image, rotate the focus ring until the image is clear. The projector will focus at distances from 4.9 to 39.4 feet (1.5 to 12.0 meters) with mechanical travel.

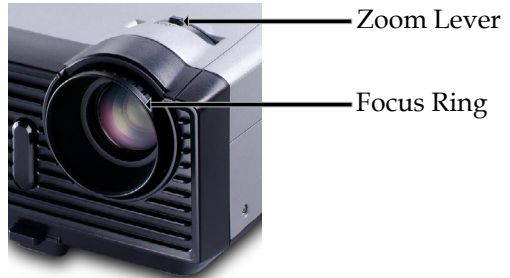

Adjusting Projection Image Size

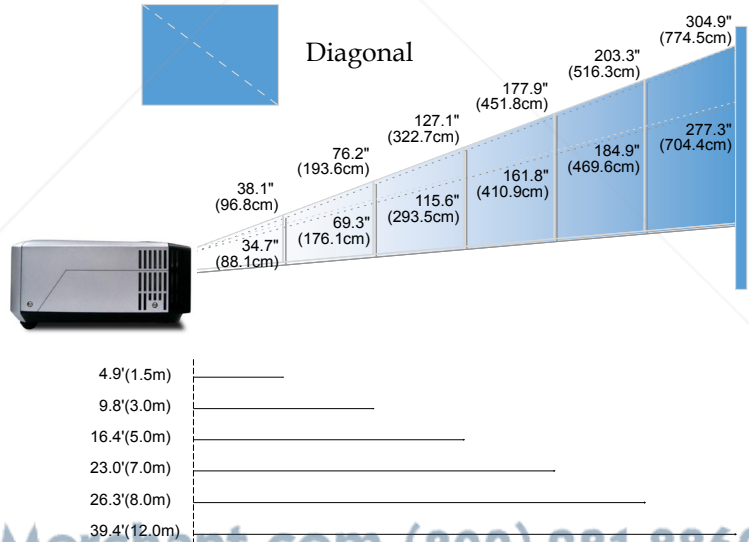

Screen (Diagonal)	Max.	38.1"(96.8cm)	76.2"(193.6cm)	127.1"(322.7cm)	177.9"(451.8cm)	203.3"(516.3cm)	304.9"(774.5cm)
	Min.	34.7"(88.1cm)	69.3"(176.1cm)	115.6"(293.5cm)	161.8"(410.9cm)	184.9"(469.6cm)	277.3"(704.4cm)
Screen Size	Max.(WxH)	30.5" x 22.9" (77.4 x 58.1cm)	61.0" x 45.7" (154.9 x 116.2cm)	101.7" x 76.3" (258.2 x 193.6cm)	142.3" x 106.7" (361.4 x 271.1cm)	162.6" x 122.0" (413.0 x 309.8cm)	243.9" x 182.9" (619.6 x 464.7cm)
	Min.(WxH)	27.8" x 20.8" (70.5 x 52.9cm)	55.4" x 41.6" (140.9 x 105.7cm)	92.5" x 69.4" (234.8 x 176.1cm)	129.4" x 97.1" (328.7 x 246.5cm)	147.9" x 110.9" (375.7 x 281.8cm)	221.8" x 166.4" (563.5 x 422.6cm)
Distance		4.9'(1.5m)	9.8'(3.0m)	16.4'(5.0m)	23.0'(7.0m)	26.3'(8.0m)	39.4'(12.0m)

❖ This graph is for user's reference only.

User Controls

Control Panel & Remote Control

There are two ways for you to control the functions: Remote Control and Control Panel.

Control Panel



Remote Control



Using the Control Panel

Power/Standby

- ▶ Refer to the “Power On/Off the Projector” section on pages 11-12.

Source

- ▶ Press “Source” to choose RGB, Component-p, Component-i, S-Video, Composite Video and HDTV sources.

Menu

- ▶ Press “Menu” to launch the on screen display (OSD) menu. To exit OSD, press “Menu” again.

Keystone ▽/▲

- ▶ Adjusts image distortion caused by tilting the projector (± 15 degrees).

Four Directional Select Keys

- ▶ Use ▲▼◀▶ to select items or make adjustments to your selection.

Enter

- ▶ Confirm your selection of items.

Re-Sync

- ▶ Automatically synchronizes the projector to the input source.

User Controls

Using the Remote Control

Power

- ▶ Refer to the "Power On/Off the Projector" section on pages 11-12.

Re-Sync

- ▶ Automatically synchronizes the projector to the input source.

Volume + / - (Vol+/Vol-)

- ▶ Increases/decreases speaker volume.

Reset

- ▶ Changes the adjustments and settings to the factory default value.

Hide

- ▶ Press "Hide" to hide image, press again to restore display of the image.

Keystone ▼ / ▲

- ▶ Adjusts image distortion caused by tilting the projector (±15 degrees).

Freeze

- ▶ Press "Freeze" to pause the screen image.

D-Zoom

- ▶ Press "D-Zoom" button to zoom in of an image.

Display Mode

- ▶ Select the display mode from PC, Movie, Game, sRGB and User.

Four Directional Select Keys

- ▶ Use ▲ ▼ ◀ ▶ to select items or make adjustments to your selection.

Enter

- ▶ Confirm your selection of items.

Menu

- ▶ Press "Menu" to launch the on screen display menu. To exit OSD, press "Menu" again.

VGA1

- ▶ Press "VGA1" to choose VGA1 connector.

VGA2

- ▶ Press "VGA2" to choose VGA2 connector.

S-Video

- ▶ Press "S-Video" to choose S-Video source.

User Controls

Composite

- ▶ Press “composite” to choose Composite video source.





Discount-Merchant.com (800) 281-8860
THE TRUSTED SOURCE FOR PROJECTOR LAMPS AND ACCESSORIES

User Controls

On Screen Display Menus

The Projector has multilingual On Screen Display menus that allow you to make image adjustments and change a variety of settings. The projector will automatically detect the source.

How to operate

1. To open the OSD menu, press "Menu"  on the Remote Control or Control Panel.
2. When OSD is displayed, use ◀ ▶ keys to select any item in the main menu. While making a selection on a particular page, press ▼ or "Enter" key to enter sub menu.
3. Use ▲ ▼ keys to select the desired item and adjust the settings by ◀ ▶ key.
4. Select the next item to be adjusted in the sub menu and adjust as described above.
5. Press "Menu"  to confirm, and the screen will return to the main menu.
6. To exit, press "Menu"  again. The OSD menu will close and the projector will automatically save the new settings.

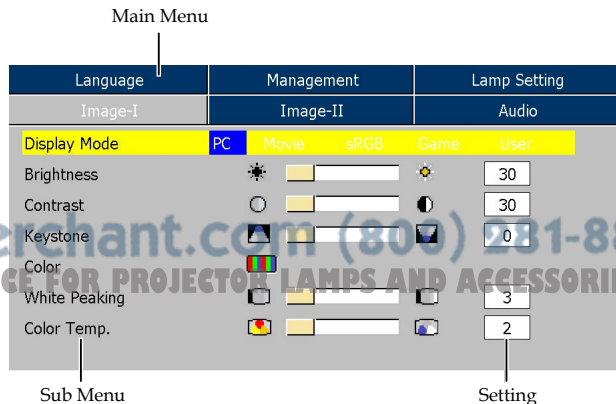

User Controls

Menu Tree

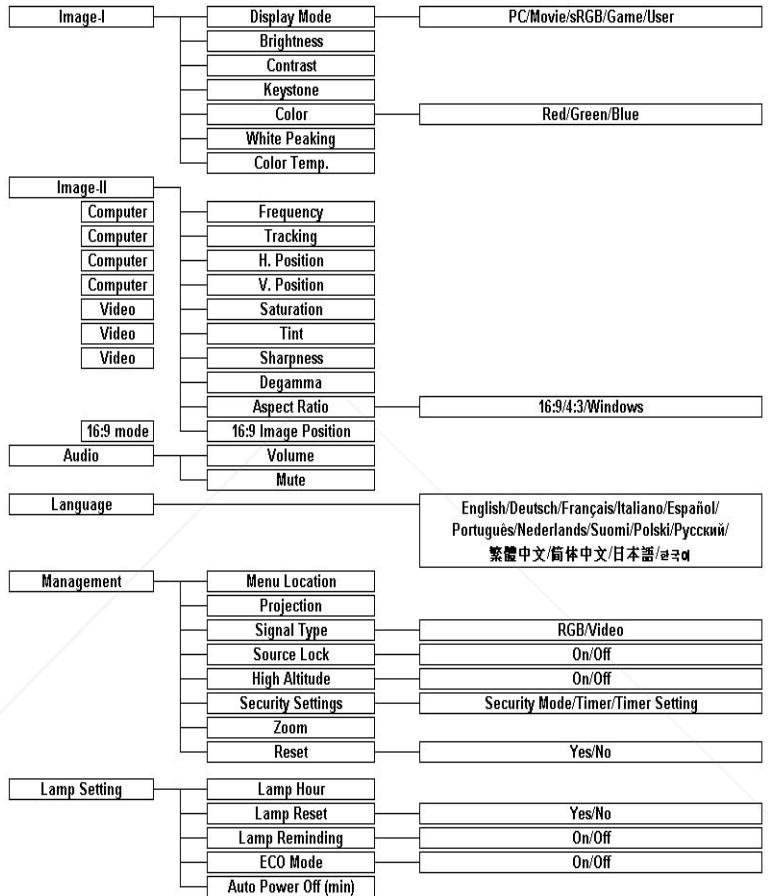

User Controls

Image-I	Image-II	Audio
Language	Management	Lamp Setting
English		Português
Français		Suomi
Deutsch		Nederlands
Italiano		简体中文
Español		繁體中文
Русский		日本語
Polski		한국어

Language

Language

Choose the multilingual OSD menu . Use the ▲ or ▼ key to select your preferred language.

Press “Enter” to finalize the selection.



FixYourDLP.com

Sponsored by 

Discount-Merchant.com (800) 281-8860

THE TRUSTED SOURCE FOR PROJECTOR LAMPS AND ACCESSORIES

User Controls

Language	Management		Lamp Setting
Image-I	Image-II		Audio
Display Mode	PC	Movie sRGB Game	User
Brightness		<input type="text" value="30"/>	30
Contrast		<input type="text" value="30"/>	30
Keystone		<input type="text" value="0"/>	0
Color			
White Peaking		<input type="text" value="3"/>	3
Color Temp.		<input type="text" value="2"/>	2

Image-I

Display Mode

There are many factory presets optimized for various types of images.

- ▶ PC: For computer or notebook.
- ▶ Movie: For home theater.
- ▶ Game : For game.
- ▶ sRGB: For standard color.
- ▶ User: Memorize user's settings.

Brightness

Adjust the brightness of the image.

- ▶ Press the ◀ to darken image.
- ▶ Press the ▶ to lighten the image.

Contrast

The contrast controls the degree of difference between the lightest and darkest parts of the picture. Adjusting the contrast changes the amount of black and white in the image.

- ▶ Press the ◀ to decrease the contrast.
- ▶ Press the ▶ to increase the contrast.

Keystone (Keystone Correction)

Adjust image distortion caused by tilting projector. (± 15 degrees)

Color

Press "Enter" to adjust the red, green and blue colors.

White Peaking

Use the white peaking control to set the white peaking level of DMD chip. 0 stands for minimal peaking, and 10 stands for



User Controls

maximum peaking. If you prefer a stronger image, adjust towards the maximum setting. For a smooth and more natural image, adjust towards the minimum setting.

Color Temp.

Adjust the color temperature. At higher temperature, the screen looks colder; at lower temperature, the screen looks warmer.



Discount-Merchant.com (800) 281-8860
THE TRUSTED SOURCE FOR PROJECTOR LAMPS AND ACCESSORIES

User Controls

Language	Management	Lamp Setting
Image-I	Image-II	Audio
Frequency	<input type="checkbox"/> <input type="checkbox"/> <input type="checkbox"/>	30
Tracking	<input type="checkbox"/> <input type="checkbox"/> <input type="checkbox"/>	30
H. Position	<input type="checkbox"/> <input type="checkbox"/> <input type="checkbox"/>	30
V. Position	<input type="checkbox"/> <input type="checkbox"/> <input type="checkbox"/>	30
Degamma	<input type="checkbox"/> <input type="checkbox"/> <input type="checkbox"/>	3
Aspect Ratio	<input type="checkbox"/> <input type="checkbox"/> <input type="checkbox"/>	4:3
16:9 Image Position	Press Enter to Set	

Image-II (Computer Mode)

Frequency

“Frequency” changes the display data frequency to match the frequency of your computer’s graphic card. If you experience a vertical flickering bar, use this function to make an adjustment.

Tracking

“Tracking” synchronizes the signal timing of the display with the graphic card. If you experience an unstable or flickering image, use this function to correct it.

H.Position (Horizontal Position)

- ▶ Press the ◀ to move the image left.
- ▶ Press the ▶ to move the image right.

V. Position (Vertical Position)



- ▶ Press the ◀ to move the image down.
- ▶ Press the ▶ to move the image up.

Degamma

This allows you to choose a degamma table that has been fine-tuned to bring out the best image quality for the input.

Aspect Ratio

Use this function to choose your desired aspect ratio.

- ▶  4:3 : The input source will be scaled to fit the projection screen.
- ▶  16:9 : The input source will be scaled to fit the width of the screen.
- ▶  Window: When a 4:3 image is bigger than a 16:9 screen, select the “Window” mode to fit the image onto the screen without changing the projection distance.

User Controls



Original Pixel



Window

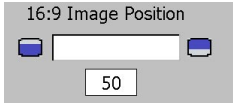

16:9 Image Position

Adjust the image position to up or down, when you select the aspect ratio to 16:9.

- ▶ Press the ◀ to move the image down.
- ▶ Press the ▶ to move the image up.



❖ 16:9 Image Position:
Image Position at window mode will also be moved accordingly.



FixYourDLP.com

Sponsored by DM

Discount-Merchant.com (800) 281-8860

THE TRUSTED SOURCE FOR PROJECTOR LAMPS AND ACCESSORIES

Language	Management	Lamp Setting
Image-I	Image-II	Audio
Degamma		3
Saturation		30
Tint		30
Sharpness		30
Aspect Ratio		4:3
16:9 Image Position	Press Enter to Set	

Image-II (Video Mode)

Degamma

This allows you to choose a degamma table that has been fine-tuned to bring out the best image quality for the input.

Saturation

Adjusts a video image from black and white to fully saturated color.

- ▶ Press the ◀ to decrease the amount of color in the image.
- ▶ Press the ▶ to increase the amount of color in the image.

Tint

Adjusts the color balance of red and green.

- ▶ Press the ◀ to increase the amount of green in the image.
- ▶ Press the ▶ to increase the amount of red in the image.

Sharpness

Adjusts the sharpness of the image.

- ▶ Press the ◀ to decrease the sharpness.
- ▶ Press the ▶ to increase the sharpness.

Aspect Ratio

Use this function to choose your desired aspect ratio.

- ▶ 4:3 : The input source will be scaled to fit the projection screen.
- ▶ 16:9 : The input source will be scaled to fit the width of the screen.
- ▶ Window: When a 4:3 image is bigger than a 16:9 screen, select the "Window" mode to fit the image onto the screen without changing the projection distance.



❖ "Saturation", "Tint" and "Sharpness" function is not supported under DVI-D mode.

User Controls



Original Pixel



Window

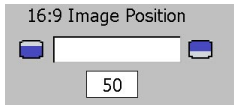

16:9 Image Position

Adjust the image position to up or down, when you select the aspect ratio to 16:9.

- ▶ Press the ◀ to move the image down.
- ▶ Press the ▶ to move the image up.



❖ 16:9 Image Position:
Image Position at window mode will also be moved accordingly.



FixYourDLP.com

Sponsored by DM

Discount-Merchant.com (800) 281-8860

THE TRUSTED SOURCE FOR PROJECTOR LAMPS AND ACCESSORIES

User Controls

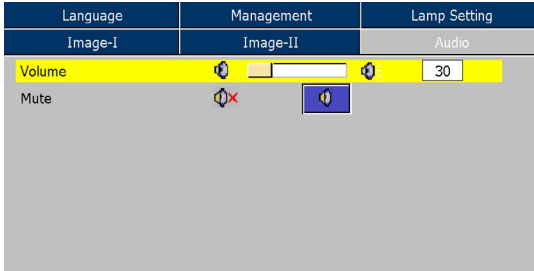

Audio

Volume

- ▶ Press the ◀ to decrease the volume.
- ▶ Press the ▶ to increase the volume.

Mute

- ▶ Choose the left icon to turn mute on.
- ▶ Choose the right icon to turn mute off.

User Controls

Image-I	Image-II	Audio
Language	Management	Lamp Setting
Menu Location		
Projection		
Signal Type	RGB	Video
Source lock	On	Off
High Altitude	On	Off
Security Settings	Press Enter to Set	
Zoom	z <input type="text"/> Z <input type="text"/>	2 <input type="text"/>
Reset	Yes	No

Management

Menu Location

Choose the menu location on the display screen.

Projection

- ▶  Front-Desktop

The factory default setting.

- ▶  Rear-Desktop

When you select this function, the projector reverses the image so you can project behind a translucent screen.

- ▶  Front-Ceiling

When you select this function, the projector turns the image upside down for ceiling-mounted projection.

- ▶  Rear-Ceiling

When you select this function, the projector reverses and turns the image upside down at same time. You can project from behind a translucent screen with ceiling mounted projection.

Signal Type

Select signal type RGB or Video sources.

Source Lock

When this function is turned off, the projector will search for other signals if the current input signal is lost. When this function is turned on, it will search specified connection port.

High Altitude

Choose "On" to turn on High Altitude mode. Operates the fans at full speed continuously to allow for proper high altitude cooling of the projector.

Security Settings

A. Press "Enter" to set password. (First time)

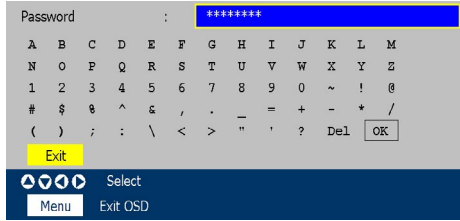

1. Password is allowed of 4~8 bits, Default value is "0000".
 2. Display on the screen by "*" while inputting.
 3. Use ▲ ▼ ◀ ▶ keys to select your input bits, and then press "Enter" key to confirm your selection.
 4. Move to **OK** and then press "Enter" key to confirm finally.
 5. On this screen, press the "Menu" key will jump to **OK** directly, and then press "Enter" key to confirm your selection. ("Menu" can be switched over between the position and **OK** at present)
 6. When input error to go to **De1** to delete the bit. (You can press the "Menu", and then press the ◀ key.)
- B. Press "Enter" to set the security protection.

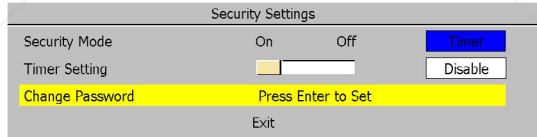

▶ Security Mode

- On: Choose "On" to use security verification while user switch on projector.
- Off: When user switch on projector without password.
- Timer: Displays the usable hours when switch on the projector. When the time remaining is 0, the time out message will appear, and then press "Menu" or "Enter" to select input password.

- ▶ Timer Setting: When the Timer is selecting, this function can be used.
- ▶ Change Password: Press "Enter" to change password.

User Controls

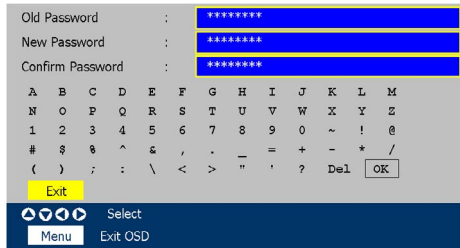

1. Input the old Password.
2. Changes a new Password.
3. Confirms the password, please input the new password once again.
4. Password is allowed of 4~8 bits, Default value is "0000".
5. Display on the screen by "*" while inputting.
6. Use ▲ ▼ ◀ ▶ keys to select your input bits, and then press "Enter" key to confirm your selection.
7. Move to **OK** and then press "Enter" key to confirm finally.
8. On this Screen, press "Menu" key to switch over between in the position at present Old Password, New Password, Confirm Password and **OK**.
9. When input error to go to **Del** to delete the bit. (You can press the "Menu", and then press the ◀ key.)



Zoom

- ▶ Press the ◀ to reduce the size of an image.
- ▶ Press the ▶ to magnify an image on the projection screen.

Reset

Choose "Yes" to return the display parameters on all menus to the factory default settings.

User Controls

Image-I	Image-II	Audio
Language	Management	Lamp Setting
Lamp Hour	 <input type="text" value="300"/>	<input type="text" value="300"/>
Lamp Reset	Yes	<input type="button" value="No"/>
Lamp Reminding	Yes	<input type="button" value="No"/>
ECO mode	On	<input type="button" value="Off"/>
Auto Power Off (min)	 <input type="text" value="180"/>	<input type="text" value="180"/>

Lamp Setting

Lamp Hours

Display the cumulative lamp operating time.

Lamp Reset

Reset the lamp life hour after replacing a new lamp.

Lamp Reminding

Choose this function to show or to hide the warning message when the changing lamp message is displayed. The message will show up 30 hours before end of life.

ECO Mode

Choose "On" to dim the projector lamp which will lower power consumption and extend the lamp life by up to 130%. Choose "Off" to return to normal mode.

Auto Power Off (min)

Sets the interval of power-off of the system, if there is no signal input. (In minutes)

Troubleshooting

If you experience trouble with the projector, refer to the following information. If the problem persists, please contact your local reseller or service center.

Problem: No image appears on screen

- ▶ Ensure all the cables and power connections are correctly and securely connected as described in the “Installation” section.
- ▶ Ensure the pins of connectors are not crooked or broken.
- ▶ Check if the projection lamp has been securely installed. Please refer to the “Replacing the lamp” section.
- ▶ Make sure you have removed the lens cap and the projector is switched on.
- ▶ Ensure that the “Hide” feature is not turned on.

Problem: Partial, scrolling or incorrectly displayed image

- ▶ Press “Re-Sync” on the remote control or control panel.
- ▶ If you are using a PC:

For Windows 3.x:

1. In the Windows Program Manager, double click the “Windows Setup” icon in the Main group.
2. Verify that your display resolution setting is less than or equal to 1280 x 1024.

For Windows 95, 98, 2000, XP:

1. From the “My Computer” icon, open the “Control Panel” folder, and double click the “Display” icon.
2. Select the “Settings” tab
3. Click on the “Advanced Properties” button.

If the projector is still not projecting the whole image, you will also need to change the monitor display you are using. Refer to the following steps.

4. Verify the resolution setting is less than or equal to 1280 x 1024 resolution.

Appendices

5. Select the "Change" button under the "Monitor" tab .
 6. Click on "Show all devices." Next, select "Standard monitor types" under the SP box; choose the resolution mode you need under the "Models" box.
- ▶ If you are using a Notebook:
 1. First, follow the steps above to adjust resolution of the computer.
 2. Press the toggle output settings. example:[Fn]+[F4]

Compaq=>	[Fn]+[F4]	Packard	=>	[Fn]+[F4]
Dell =>	[Fn]+[F8]	Hewlett	=>	[Fn]+[F4]
Gateway=>	[Fn]+[F4]	NEC=>		[Fn]+[F3]
IBM=>	[Fn]+[F7]	Toshiba =>		[Fn]+[F5]

Mac Apple:
System Preference-->Display-->Arrangement-->Mirror display

- ▶ If you experience difficulty changing resolutions or your monitor freezes, restart all equipment including the projector.

Problem: The screen of the Notebook or PowerBook computer is not displaying a presentation

- ▶ If you are using a Notebook PC:

Some Notebook PCs may deactivate their own screens when a second display device is in use. Each has a different way to be reactivated. Refer to your computer's documentation for detailed information.

Problem: Image is unstable or flickering

- ▶ Use "Tracking" to correct it.
- ▶ Change the monitor color setting from your computer.

Problem: Image has vertical flickering bar

Use "Frequency" to make an adjustment.

Check and reconfigure the display mode of your graphic card to make it compatible with the product.

Problem: Image is out of focus

- ▶ Adjusts the Focus Ring on the projector lens.

Appendices

- ▶ Make sure the projection screen is between the required distance 4.9 to 39.4 feet (1.5 to 12.0 meters) from the projector. See page 14.

Problem: The image is stretched when displaying 16:9 DVD

The projector automatically detects 16:9 DVD and adjusts the aspect ratio by digitizing to full screen with 4:3 default setting.

If the image is still stretched, you will also need to adjust the aspect ratio by referring to the following:

- ▶ Please select 4:3 aspect ratio type on your DVD player if you are playing a 16:9 DVD.
- ▶ If you can't select 4:3 aspect ratio type on your DVD player, please select 4:3 aspect ratio in the on screen menu.

Problem: Image is reversed

- ▶ Select "Management-->Projection" from the OSD and adjust the projection direction.

Problem: Lamp burns out or makes a popping sound

- ▶ When the lamp reaches its end of life, it will burn out and may make a loud popping sound. If this happens, the projector will not turn on until the lamp module has been replaced. To replace the lamp, follow the procedures in the "Replacing the Lamp".

Problem: LED lighting message

Message	Power-LED (Green)	Temp-LED	Lamp-LED
Standby State (Input power cord)	Flashing	○	○
Lamp lighting	☀	○	○
Power on	☀	○	○
Power off (Cooling)	☀	○	○
Error (Lamp fail)	○	○	☀
Error (Thermal fail)	☀	☀	○
Error (Fan fail)	○	Flashing	○
Error (Over Temp.)	○	☀	○
Error (Lamp Breakdown)	○	○	☀

NOTE

YourDLP.com

Steady light => ☀
No light => ○

Appendices

Problem: Message Reminders

- ▶ Fan failed:

Fan Fail.
Lamp will automatically turn off soon.

- ▶ Over temperature:

Projector Overheated.
Lamp will automatically turn off soon.

- ▶ Replacing the lamp:

Lamp is approaching the end of its useful life in full power operation.
Replacement suggested!

- ▶ Password error :

Password is not correct !
Try again !

- ▶ Time out:

Time out! Please contact your dealer.

Replacing the lamp

The projector will detect the lamp life itself. It will show you a warning message

Lamp is approaching the end of its useful life in full power operation.
Replacement suggested!



Warning: Lamp compartment is hot! Allow it to cool down before changing lamp!

When you see this message, change the lamp as soon as possible.

Make sure the projector has been cooled down for at least 30 minutes before changing the lamp.

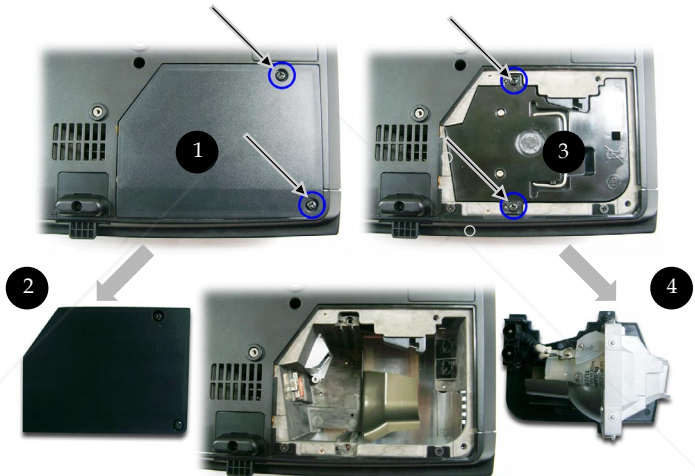

Warning: To prevent personal injury, do not touch the lens or drop the lamp module or touch the lamp bulb. The bulb may shatter and cause injury if it is dropped.

Lamp Replacing Procedure:

1. Switch off the power to the projector by pressing the Power/ Standby button.
2. Allow the projector to cool down at least 30 minutes.
3. Disconnect the power cord.
4. Use a screwdriver to remove the screw from the cover. ❶
5. Push up and remove the cover. ❷
6. Remove the 2 screws from the lamp module. ❸
7. Pull out the lamp module. ❹

To replace the lamp module, reverse the previous steps.

Appendices

Compatibility Modes

Mode	Resolution	(ANALOG)	
		V.Frequency (Hz)	H.Frequency (kHz)
VESA VGA	640 x 350	70	31.5
VESA VGA	640 x 350	85	37.9
VESA VGA	640 x 400	85	37.9
VESA VGA	640 x 480	60	31.5
VESA VGA	640 x 480	72	37.9
VESA VGA	640 x 480	75	37.5
VESA VGA	640 x 480	85	43.3
VESA VGA	720 x 400	70	31.5
VESA VGA	720 x 400	85	37.9
VESA SVGA	800 x 600	56	35.2
VESA SVGA	800 x 600	60	37.9
VESA SVGA	800 x 600	72	48.1
VESA SVGA	800 x 600	75	46.9
VESA SVGA	800 x 600	85	53.7
* VESA XGA	1024 x 768	60	48.4
* VESA XGA	1024 x 768	70	56.5
* VESA XGA	1024 x 768	75	60.0
* VESA XGA	1024 x 768	85	68.7
* VESA SXGA	1152 x 864	70	63.8
* VESA SXGA	1152 x 864	75	67.5
* VESA SXGA	1280 x 1024	60	63.98
* VESA SXGA	1280 x 960	60	60.0
MAC LC 13"	640 x 480	66.66	34.98
MAC II 13"	640 x 480	66.68	35
MAC 16"	832 x 624	74.55	49.725
* MAC 19"	1024 x 768	75	60.24
* MAC	1152 x 870	75.06	68.68
MAC G4	640 x 480	60	31.35
* i MAC DV	1024 x 768	75	60
* i MAC DV	1152 x 870	75	68.49



Remark : "*" compressed computer image.

Ceiling Mount Installation

1. To prevent damaging your projector, please use the ceiling mount package for installation.
2. If you wish to use a third party ceiling mount kit, please ensure the screws used to attached a mount to the projector met the following specifications:

- ▶ **Screw type: M2.6**
- ▶ **Maximum screw length: 10mm**
- ▶ **Minimum screw length: 8mm**



❖ Please note that damage resulting from incorrect installation will invalidate the warranty.



Warning:
1.> If you buy the ceiling mount from other company, please ensure that there is at least 10cm distance between the bottom cover of the projector and the ceiling.

2.> Don't install the projector near the air condition and the heater, avoid flowing into the projector directly that caused it

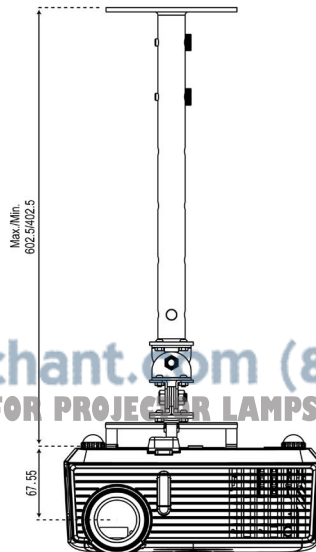
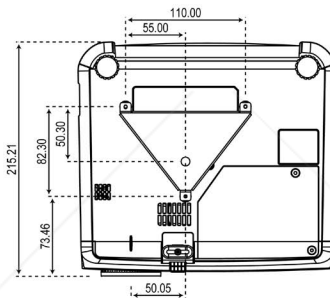

Find Your DLP.com
Sponsored by DM

Discount-Merchant.com (800) 281-8860
THE TRUSTED SOURCE FOR PROJECTOR LAMPS AND ACCESSORIES



Disclaimer

This user manual is provided as a free service by FixYourDLP.com. FixYourDLP is in no way responsible for the content of this manual, nor do we guarantee its accuracy. FixYourDLP does not make any claim of copyright and all copyrights remain the property of their respective owners.

About FixYourDLP.com

FixYourDLP.com (<http://www.fixyourdpl.com>) is the World's #1 resource for media product news, reviews, do-it-yourself guides, and manuals.

Informational Blog: <http://www.fixyourdpl.com>

Video Guides: <http://www.fixyourdpl.com/guides>

User Forums: <http://www.fixyourdpl.com/forum>

FixYourDLP's Fight Against Counterfeit Lamps:

<http://www.fixyourdpl.com/counterfeits>

Sponsors:

RecycleYourLamp.org – Free lamp recycling services for used lamps:

<http://www.recycleyourlamp.org>

Lamp Research - The trusted 3rd party lamp research company:

<http://www.lampresearch.com>

Discount-Merchant.com – The worlds largest lamp distributor:

<http://www.discount-merchant.com>



FixYourDLP.com

Sponsored by 