



# Disclaimer

This user manual is provided as a free service by FixYourDLP.com. FixYourDLP is in no way responsible for the content of this manual, nor do we guarantee its accuracy. FixYourDLP does not make any claim of copyright and all copyrights remain the property of their respective owners.

About FixYourDLP.com

FixYourDLP.com (<http://www.fixyourdpl.com>) is the World's #1 resource for media product news, reviews, do-it-yourself guides, and manuals.

Informational Blog: <http://www.fixyourdpl.com>

Video Guides: <http://www.fixyourdpl.com/guides>

User Forums: <http://www.fixyourdpl.com/forum>

FixYourDLP's Fight Against Counterfeit Lamps:

<http://www.fixyourdpl.com/counterfeits>

## Sponsors:

RecycleYourLamp.org – Free lamp recycling services for used lamps:

<http://www.recycleyourlamp.org>

Lamp Research - The trusted 3rd party lamp research company:

<http://www.lampresearch.com>

Discount-Merchant.com – The worlds largest lamp distributor:

<http://www.discount-merchant.com>



**FixYourDLP.com**

Sponsored by 

# Table of Contents

<b>Table of Contents</b> .....	<b>1</b>
<b>Usage Notice</b> .....	<b>2</b>
<i>Precautions</i> .....	2
<b>Introduction</b> .....	<b>4</b>
<i>Product Features</i> .....	4
<i>Package Overview</i> .....	5
<i>Product Overview</i> .....	6
<i>Main Unit</i> .....	6
<i>Control Panel</i> .....	7
<i>Connection Ports</i> .....	8
<i>Remote Control</i> .....	9
<b>Installation</b> .....	<b>10</b>
<i>Connecting the Projector</i> .....	10
<i>Powering On/Off the Projector</i> .....	11
<i>Powering On the Projector</i> .....	11
<i>Powering Off the projector</i> .....	12
<i>Warning Indicator</i> .....	12
<i>Adjusting the Projected Image</i> .....	13
<i>Adjusting the Projector Image Height</i> .....	13
<i>Adjusting the Projector Zoom / Focus</i> .....	14
<i>Adjusting Projected Image Size</i> .....	14
<b>User Controls</b> .....	<b>15</b>
<i>Control Panel &amp; Remote Control</i> .....	15
<i>On-Screen Display Menus</i> .....	18
<i>How to operate</i> .....	18
<i>Language</i> .....	19
<i>Image-I</i> .....	20
<i>Image-II (Computer Mode)</i> .....	22
<i>Image-II (Video Mode)</i> .....	24
<i>Audio</i> .....	26
<i>Management</i> .....	27
<i>Lamp Setting</i> .....	29
<b>Appendices</b> .....	<b>30</b>
<i>Troubleshooting</i> .....	30
<i>Replacing the lamp</i> .....	34
<i>Compatibility Modes</i> .....	35
<i>Ceiling Mount Installation</i> .....	36



FixYourDLP.com  
Sponsored by











Discount-Merchant.com (800) 281-8800

THE TRUSTED SOURCE FOR PROJECTOR LAMPS AND ACCESSORIES

# Usage Notice

## Precautions

*Follow all warnings, precautions and maintenance as recommended in this user's guide to maximize the life of your unit.*

-  **Warning-** Do not look into the projector's lens when the lamp is on. The bright light may hurt your eyes.
-  **Warning-** To reduce the risk of fire or electric shock, do not expose this product to rain or moisture.
-  **Warning-** Please do not open or disassemble the product as this may cause electric shock.
-  **Warning-** When changing the lamp, please allow unit to cool down, and follow all changing instructions.
-  **Warning-** This product will detect the life of the lamp itself. Please be sure to change the lamp when it shows warning messages.
-  **Warning-** Reset the "Lamp Reset" function from the On Screen Display "Lamp Setting" menu after replacing the lamp module (refer to page 29).
-  **Warning-** When switching the projector off, please ensure the projector completes its cooling cycle before disconnecting power.
-  **Warning-** Turn on the projector first and then the signal sources.
-  **Warning-** Do not use lens cap when projector is in operation.
-  **Warning-** When the lamp reaches the end of its life, it will burn out and may make a loud popping sound. If this happens, the projector will not turn back on until the lamp module has been replaced. To replace the lamp, follow the procedures listed under "Replacing the Lamp".

# Usage Notice

## **Do:**

- ❖ Turn off the product before cleaning.
- ❖ Use a soft cloth moistened with mild detergent to clean the display housing.
- ❖ Disconnect the power plug from AC outlet if the product is not being used for a long period of time.

## **Don't:**

- ❖ Block the slots and openings on the unit provided for ventilation.
- ❖ Use abrasive cleaners, waxes or solvents to clean the unit.
- ❖ Use under the following conditions:
  - In extremely hot, cold or humid environments.
  - In areas susceptible to excessive dust and dirt.
  - Near any appliance that generates a strong magnetic field.
  - Place in direct sunlight.



**Discount-Merchant.com (800) 281-8860**  
**THE TRUSTED SOURCE FOR PROJECTOR LAMPS AND ACCESSORIES**

# Introduction

## Product Features

*This product is an XGA single chip 0.7" DLP™ projector. Outstanding features include:*

- ◆ True XGA, 1024 x 768 addressable pixels
- ◆ Single chip DLP™ technology
- ◆ NTSC/NTSC4.43/PAL/PAL-M/PAL-N/SECAM and HDTV compatible (480i/p, 576i/p, 720p, 1080i)
- ◆ High-tech DVI connection for digital signal with HDCP function and supports 480p, 576p, 720p and 1080i
- ◆ Full function remote control
- ◆ User friendly multilingual on screen display menu
- ◆ Advanced **digital** keystone correction and high quality full screen image re-scaling
- ◆ User friendly control panel
- ◆ SXGA+, SXGA compression and VGA, SVGA re-sizing
- ◆ Mac compatible



**Discount-Merchant.com (800) 281-8860**  
**THE TRUSTED SOURCE FOR PROJECTOR LAMPS AND ACCESSORIES**

# Introduction

## Package Overview

*This projector comes with all the items shown below. Check to make sure your unit is complete. Contact your dealer immediately if anything is missing.*



Projector with lens cap



Power Cord 1.8m



VGA Cable 1.8m



Composite Video Cable  
2.0m



Audio Cable Jack/Jack  
1.8m



Remote Control



2 x Battery



SCART RGB Adaptor  
(For European Use Only)

### Documents :

- User's Guide
- Quick Start Card
- Warranty Card

# Introduction

## Product Overview

### Main Unit

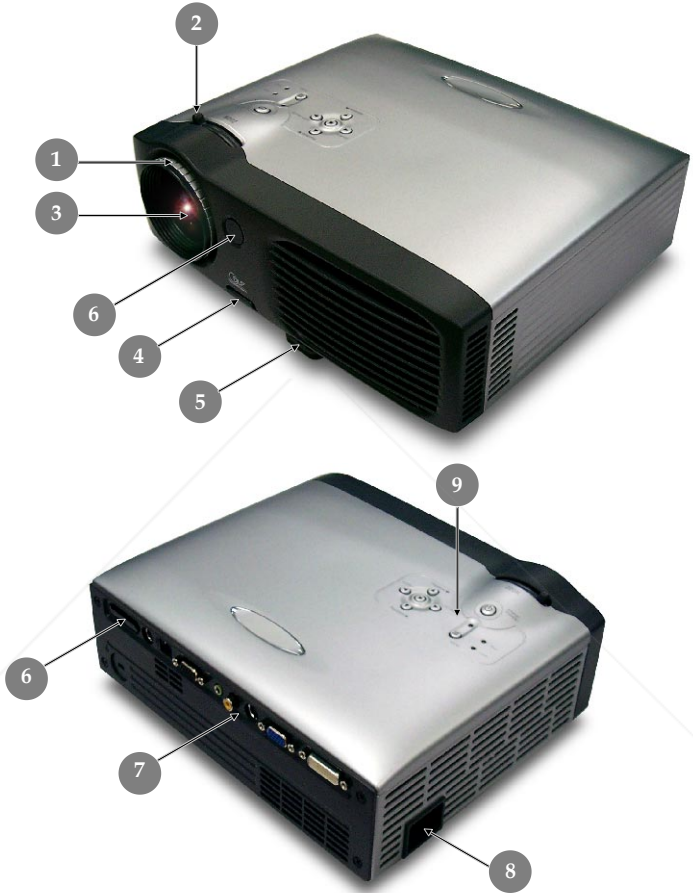

1. Focus Ring
2. Zoom Ring
3. Zoom Lens
4. Elevator Button
5. Elevator Foot
6. Remote Control Receiver
7. Connection Ports
8. Power Socket
9. Control Panel

# Introduction

## Control Panel

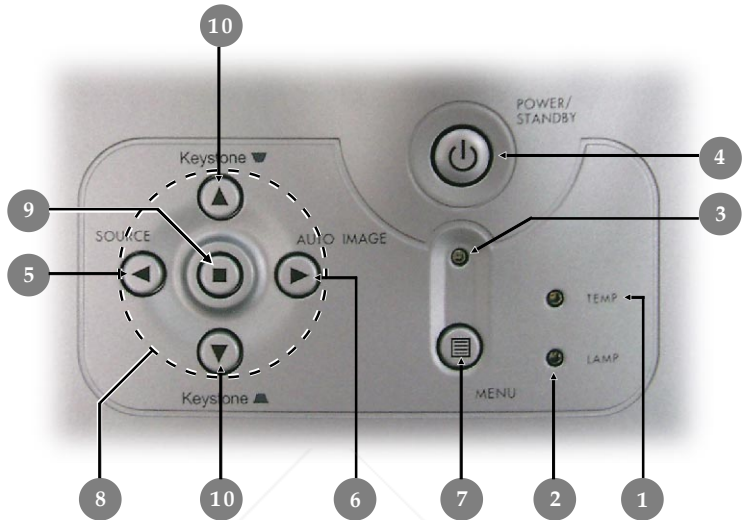

1. Temp Indicator LED
2. Lamp Indicator LED
3. Power Indicator LED
4. Power/Standby
5. Source
6. Auto Image
7. Menu (On/Off)
8. Four Directional Select Keys
9. Enter
10. Keystone Correction



# Introduction

## Connection Ports

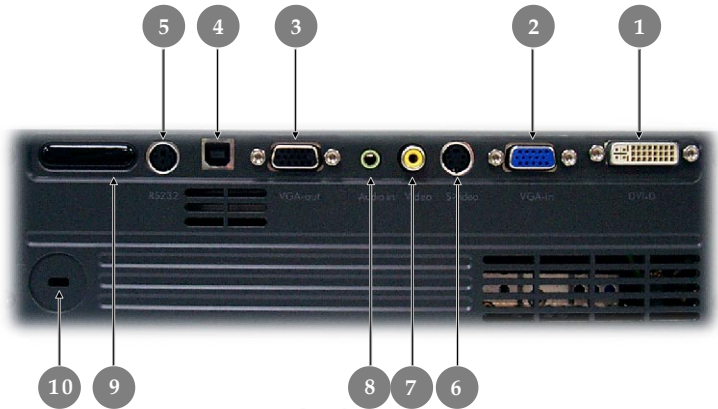

1. DVI-D Input Connector (for Digital signal with HDCP function)
2. PC Analog Signal/HDTV/Component Video Input Connector
3. Monitor Loop-through Output Connector
4. USB Input Connector
5. RS232 Input Connector
6. S-Video Input Connector
7. Composite Video Input Connector
8. Audio Input Connector
9. Remote Control Receiver
10. Kensington™ Lock Port



**Discount-Merchant.com (800) 281-8860**  
THE TRUSTED SOURCE FOR PROJECTOR LAMPS AND ACCESSORIES

# Introduction

## Remote Control

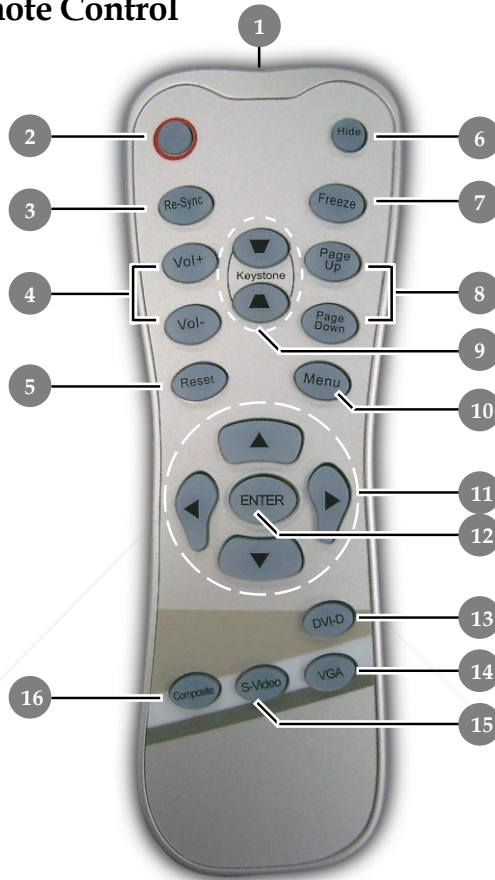

- |                                  |                            |
|----------------------------------|----------------------------|
| 1. Transmit Indicator Light      | 12. Enter                  |
| 2. Power                         | 13. DVI-D Source           |
| 3. Re-Sync                       | 14. VGA Source             |
| 4. Volume ( + / - )              | 15. S-Video Source         |
| 5. Reset                         | 16. Composite Video Source |
| 6. Hide                          |                            |
| 7. Freeze                        |                            |
| 8. Page Up / Page Down           |                            |
| 9. Keystone Correction           |                            |
| 10. Menu                         |                            |
| 11. Four Directional Select Keys |                            |

# Installation

## Connecting the Projector

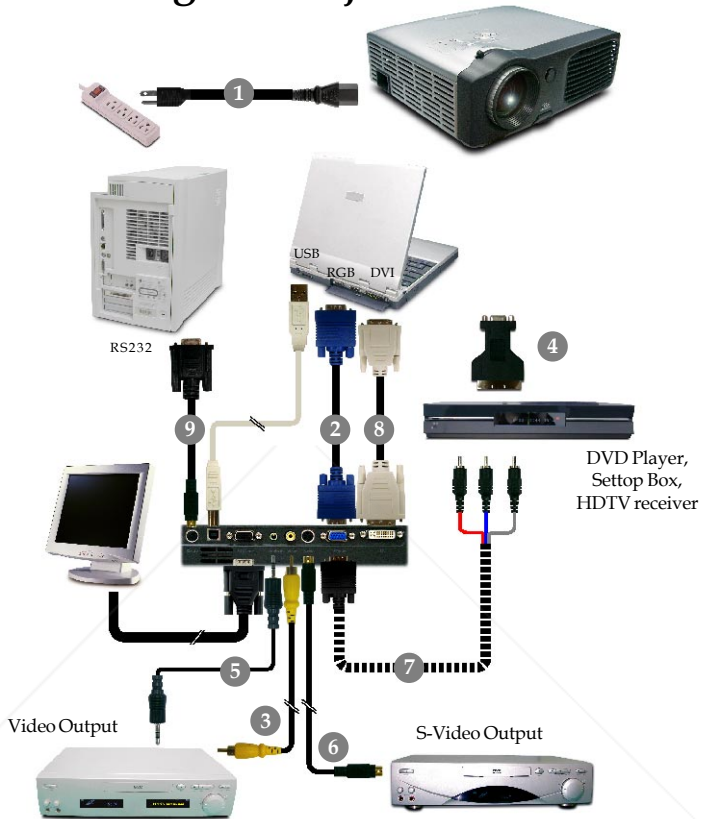

- 1..... Power Cord
- 2..... VGA Cable
- 3..... Composite Video Cable
- 4..... SCART RGB Adaptor (For European Use Only)
- 5..... Audio Cable Jack/Jack
- 6..... S-Video Cable (Optional Accessory)
- 7..... D-Sub to RCA Cable for HDTV/Component (Optional Accessory)
- 8..... DVI to DVI Cable (Optional Accessory)
- 9..... RS232 Cable (Optional Accessory)

FixYourDLP.com  
Sponsored by DM

Discount-Merchant.com

THE TRUSTED SOURCE FOR PROJECTOR, LAPTOP AND ACCESSORIES

To ensure the projector works well with your computer, please set the display mode of your graphic card less than or equal to 1024 X 768 resolution. Make sure the timing of the display mode is compatible with the projector. Refer to the "Compatibility Modes" section on page 35.

## Powering On/Off the Projector

### Powering On the Projector

#### Quick Menu



1. Remove the lens cap.
2. Ensure that the power cord and signal cable are securely connected. The Power LED will flash **green**.
3. Turn on the lamp by pressing “Power/Standby” button on the control panel. **1** And the **Power LED** will turn **green**.  
First time use the projector, you can select your preferred language from quick menu after the startup screen display.
4. Turn on your source (computer, notebook, video player ,etc.).  
The projector will detect your source automatically.

- ❖ If the screen displays “No Signal”, please make sure the signal cables are securely connected.
- ❖ If you connect multiple sources at the same time, use the “Source” button on the control panel to switch.



❖ Turn on the projector first and then the signal sources.



Discount-Merchant.com (910) 281-8860  
THE TRUSTED SOURCE FOR PROJECTOR LAMPS AND ACCESSORIES



# Installation

## Powering Off the Projector

1. Press the “Power/Standby” button to turn off the projector lamp, you will see a message “Power off the lamp? Picture Mute” displayed on the projector’s screen. Press the “Power/Standby” button again to confirm, otherwise the message will disappear after 5 seconds.

Please note that if the  key is pressed instead, the projector will enter the “Picture Mute” mode and no image will be displayed. To exit the “Picture Mute” mode, press the “Power/Standby” button again.

2. The cooling fans continue to operate for about **60** seconds for cooling cycle and the Power LED will turn **green**. When the Power LED begins flashing, the projector has entered standby mode.

If you wish to turn the projector back on, you must wait until the projector has completed the cooling cycle and has entered standby mode. Once in standby mode, simply press “Power/Standby” button to restart the projector.

3. Disconnect the power cord from the electrical outlet and the projector.
4. Do not turn on the projector immediately following a power off procedure.

## Warning Indicator

❖ *When the “LAMP” indicator lights solid red, the projector will automatically shut itself down. Please contact your local reseller or service center.*

❖ *When the “TEMP” indicator lights solid red for about **20** seconds, it indicates the projector has been overheated. You will see a message “Projector Overheated. Lamp will automatically turn off soon.” on the on-screen display. The projector will automatically shut itself down.*

*Under normal conditions, the projector can be switched on again after it has cooled down. If the problem persists, you should contact your local dealer or our service center.*

❖ *When the “TEMP” indicator flashes red for about **10** seconds, you will see a message “Fan fail. Lamp will automatically turn off soon.” on the on-screen display. Please contact your local dealer or our service center.*

## Adjusting the Projected Image

### Adjusting the Projector Image Height

*The projector is equipped with an elevator foot for adjusting the image height.*

To raise the image:

1. Press the elevator button **1**.
2. Raise the image to the desired height angle **2**, then release the button to lock the elevator foot into position.
3. Use **3** to fine-tune the display angle.

To lower the image:

1. Press the elevator button.
2. Lower the image, then release the button to lock the elevator foot into position.
3. Use **3** to fine-tune the display angle.



# Installation

## Adjusting the Projector Zoom/Focus

You may turn the zoom ring to zoom in or out. To focus the image, rotate the focus ring until the image is clear. The projector will focus at distances from 3.9 to 32.8feet (1.2 to 10.0 meters).

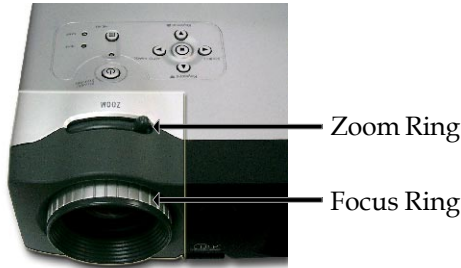

## Adjusting Projection Image Size

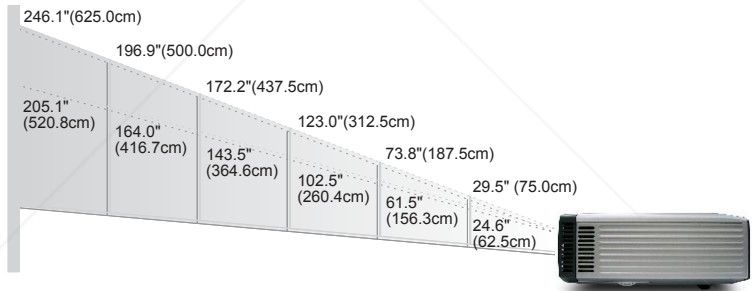

						3.94'(1.2m)	
						9.84'(3.0m)	
						16.40'(5.0m)	
						22.97'(7.0m)	
						26.25'(8.0m)	
						32.81'(10.0m)	
Screen (Diagonal)	Max.	29.5"(75.0cm)	73.8"(187.5cm)	123.0"(312.5cm)	172.2"(437.5cm)	196.9"(500.0cm)	246.1"(625.0cm)
	Min.	24.6"(62.5cm)	61.5"(156.3cm)	102.5"(260.4cm)	143.5"(364.6cm)	164.0"(416.7cm)	205.1"(520.8cm)
Screen Size	Max.(WxH)	23.60" x 14.70" (60.0 x 45.0cm)	59.04" x 44.28" (150.0 x 112.5cm)	98.40" x 73.80" (250.0 x 187.5cm)	137.76" x 103.32" (350.0 x 262.5cm)	157.52" x 118.14" (400.0 x 300.0cm)	196.88" x 147.66" (500.0 x 375.0cm)
	Min.(WxH)	19.68" x 14.76" (50.0 x 37.5cm)	49.20" x 36.90" (125.0 x 93.8cm)	82.00" x 61.50" (208.3 x 156.2cm)	114.80" x 86.10" (291.7 x 218.8cm)	131.20" x 98.40" (333.4 x 250.0cm)	164.08" x 123.06" (416.6 x 312.5cm)
Distance		3.94'(1.2m)	9.84'(3.0m)	16.40'(5.0m)	22.97'(7.0m)	26.25'(8.0m)	32.81'(10.0m)

❖ This graph is for user's reference only.



# User Controls

## Control Panel & Remote Control

There are two ways for you to control the functions: Remote Control and Control Panel.

### Control Panel



### Remote Control



#### Using the Control Panel

##### Power/Standby

- ▶ Refer to the “Power On/Off the Projector” section on pages 11-12.

##### Source

- ▶ Press “Source” to choose RGB, Component-p, Component-i, S-Video, Composite Video and HDTV sources.

##### Menu

- ▶ Press “Menu” to launch the on screen display (OSD) menu. To exit OSD, press “Menu” again.

##### Keystone /Keystone

- ▶ Adjusts image distortion caused by tilting the projector ( $\pm 16$  degrees).

##### Four Directional Select Keys

- ▶ Use     to select items or make adjustments to your selection.

##### Enter

- ▶ Confirm your selection of items.

##### Auto Image

- ▶ Automatically synchronizes the projector to the input source.



# User Controls

## Using the Remote Control

### Power/Standby

- ▶ Refer to the "Power On/Off the Projector" section on pages 11-12.

### Re-Sync

- ▶ Automatically synchronizes the projector to the input source.

### Volume +/- (Vol+/Vol-)

- ▶ Increases/decreases speaker volume.

### Reset

- ▶ Changes the adjustments and settings to the factory default value.

### Hide

- ▶ Press "Hide" to hide image, press again to restore display of the image.

### Keystone ▼ / ▲

- ▶ Adjusts image distortion caused by tilting the projector ( $\pm 16$  degrees).

### Page Up (Computer mode only)

- ▶ Use this button to page up. This function is only available when the projector is connected to a computer via an USB cable.

### Page Down (Computer mode only)

- ▶ Use this button to page down. This function is only available when the projector is connected to a computer via an USB cable.

### Freeze

- ▶ Press "Freeze" to pause the screen image.

### Four Directional Select Keys

- ▶ Use ▲ ▼ ◀ ▶ to select items or make adjustments to your selection.

### Menu

- ▶ Press "Menu" to launch the on screen display menu. To exit OSD, press "Menu" again.

### Enter

- ▶ Confirm your selection of items.

### VGA

- ▶ Press "VGA" to choose Analog RGB, component and HDTV source.

### S-Video

- ▶ Press "S-Video" to choose S-Video source.

# *User Controls*

## **Composite**

- ▶ Press “composite” to choose Composite video source.

## **DVI-D**

- ▶ Press “DVI-D” to choose DVI-D connector.



**Discount-Merchant.com (800) 281-8860**  
**THE TRUSTED SOURCE FOR PROJECTOR LAMPS AND ACCESSORIES**

## On Screen Display Menus

The Projector has multilingual On Screen Display menus that allow you to make image adjustments and change a variety of settings. The projector will automatically detect the source.

### How to operate

1. To open the OSD menu, press “Menu” on the Remote Control or Control Panel.
2. When OSD is displayed, use ◀ ▶ keys to select any item in the main menu. While making a selection on a particular page, press ◻ “Enter” key to enter sub menu.
3. Use ▲ ▼ keys to select the desired item and adjust the settings by ◀ ▶ key.
4. Select the next item to be adjusted in the sub menu and adjust as described above.
5. Press “Menu” to confirm, and the screen will return to the main menu.
6. To exit, press “Menu” again. The OSD menu will close and the projector will automatically save the new settings.

Main Menu

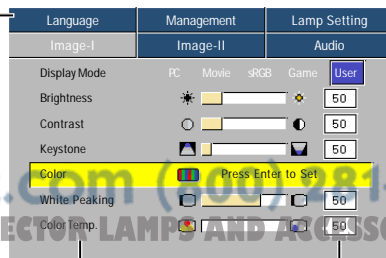

Sub Menu

Setting

## Computer / Video Mode

Image-I	Image-II	Audio
Language	Management	Lamp setting
English		Português
Deutsch		日本語
Français		繁體中文
Italiano		简体中文
Español		한국어
Russian		

## Language

### Language

Choose the multilingual OSD menu . Use the ▲ or ▼ key to select your preferred language.

Press ◻ “Enter” to finalize the selection.

# User Controls

## Computer / Video Mode

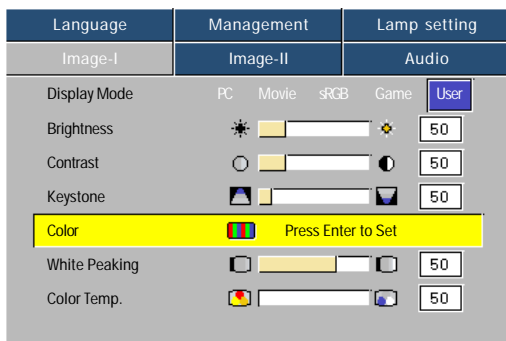

## Image-I

### Display Mode

There are many factory presets optimized for various types of images.

- ▶ PC : For computer or notebook.
- ▶ Movie : For home theater.
- ▶ Game : For game.
- ▶ sRGB : For PC standard color.
- ▶ User : Memorize user's settings.

### Brightness

Adjust the brightness of the image.

- ▶ Press the ◀ to darken image.
- ▶ Press the ▶ to lighten the image.

### Contrast

The contrast controls the degree of difference between the lightest and darkest parts of the picture. Adjusting the contrast changes the amount of black and white in the image.

- ▶ Press the ◀ to decrease the contrast.
- ▶ Press the ▶ to increase the contrast.

### Keystone (Keystone Correction)





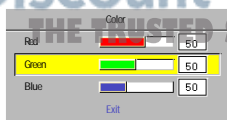

Adjust image distortion caused by tilting projection. (±16 degrees)

### Color

Press "Enter" to adjust the red, green and blue colors.

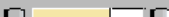

## Computer / Video Mode

Language	Management	Lamp setting
Image-I	Image-II	Audio
Display Mode	PC Movie sRGB Game <b>User</b>	
Brightness		50
Contrast		50
Keystone		50
<b>Color</b>	 Press Enter to Set	
White Peaking		50
Color Temp.		50

## Image-I

### White Peaking

Use the white peaking control to set the white peaking level of DMD chip. 0 stands for minimal peaking, and 10 stands for maximum peaking. If you prefer a stronger image, adjust towards the maximum setting. For a smooth and more natural image, adjust towards the minimum setting.

### Color Temp.

Adjust the color temperature. At higher temperature, the screen looks colder; at lower temperature, the screen looks warmer.

# User Controls

## Computer Mode

Language	Management	Lamp setting
Image-I	Image-II	Audio
Frequency	<input type="checkbox"/> <input type="text"/>	<input type="checkbox"/> 50
Tracking	<input type="checkbox"/> <input type="text"/>	<input type="checkbox"/> 50
H. Position	<input type="checkbox"/> <input type="text"/>	<input type="checkbox"/> 50
V. Position	<input type="checkbox"/> <input type="text"/>	<input type="checkbox"/> 50
Degamma	<input type="checkbox"/> <input type="text"/>	<input type="checkbox"/> 50
Aspect Ratio	<input type="checkbox"/> <input type="checkbox"/> <input type="checkbox"/>	16:9

16:9 Image Position Press Enter to Set

## Image-II (Computer Mode)

### Frequency

“Frequency” changes the display data frequency to match the frequency of your computer’s graphic card. If you experience a vertical flickering bar, use this function to make an adjustment.

### Tracking

“Tracking” synchronizes the signal timing of the display with the graphic card. If you experience an unstable or flickering image, use this function to correct it.

### H.Position (Horizontal Position)

- ▶ Press the ◀ to move the image left.
- ▶ Press the ▶ to move the image right.

### V. Position (Vertical Position)



- ▶ Press the ◀ to move the image down.
- ▶ Press the ▶ to move the image up.

### Degamma

This allows you to choose a degamma table that has been fine-tuned to bring out the best image quality for the input.

### Aspect Ratio

Use this function to choose your desired aspect ratio.

- ▶  4:3 : The input source will be scaled to fit the projection screen.
- ▶  16:9 : The input source will be scaled to fit the width of the screen.

## Computer Mode

Language	Management	Lamp setting
Image-I	Image-II	Audio
Frequency	<input type="checkbox"/> <input type="text" value=""/>	<input type="checkbox"/> <input type="text" value="50"/>
Tracking	<input type="checkbox"/> <input type="text" value=""/>	<input type="checkbox"/> <input type="text" value="50"/>
H. Position	<input type="checkbox"/> <input type="text" value=""/>	<input type="checkbox"/> <input type="text" value="50"/>
V. Position	<input type="checkbox"/> <input type="text" value=""/>	<input type="checkbox"/> <input type="text" value="50"/>
Degamma	<input type="checkbox"/> <input type="text" value=""/>	<input type="checkbox"/> <input type="text" value="50"/>
<b>Aspect Ratio</b>	<input checked="" type="radio"/> <input type="radio"/> <input type="radio"/>	<input type="text" value="16:9"/>
16:9 Image Position	Press Enter to Set	

## Image-II (Computer Mode)

- ▶  Window: When a 4:3 image is bigger than a 16:9 screen, select the "Window" mode to fit the image onto the screen without changing the projection distance.





Original Pixel



Window

### 16:9 Image Position

Adjust the image position to up or down, when you select the aspect ratio to 16:9.





- ▶ Press the  to move the image down.
- ▶ Press the  to move the image up.





# User Controls

## Video Mode

Language	Management	Lamp setting
Image-I	Image-II	Audio
Degamma	 <input type="text" value="50"/>	<input type="text" value="50"/>
Saturation	 <input type="text" value="50"/>	<input type="text" value="50"/>
Tint	 <input type="text" value="50"/>	<input type="text" value="50"/>
Sharpness	 <input type="text" value="50"/>	<input type="text" value="50"/>
Aspect Ratio	 <input type="text" value="16:9"/>	<input type="text" value="16:9"/>
16:9 Image Position	Press Enter to Set	

## Image-II (Video Mode)

### Degamma

This allows you to choose a degamma table that has been fine-tuned to bring out the best image quality for the input.

### Saturation

Adjusts a video image from black and white to fully saturated color.

- ▶ Press the ◀ to decrease the amount of color in the image.
- ▶ Press the ▶ to increase the amount of color in the image.

### Tint

Adjusts the color balance of red and green.

- ▶ Press the ◀ to increase the amount of green in the image.
- ▶ Press the ▶ to increase the amount of red in the image.



### Sharpness

Adjusts the sharpness of the image.

- ▶ Press the ◀ to decrease the sharpness.
- ▶ Press the ▶ to increase the sharpness.

### Aspect Ratio

Use this function to choose your desired aspect ratio.

- ▶  4:3 : The input source will be scaled to fit the projection screen.
- ▶  16:9 : The input source will be scaled to fit the width of the screen.
- ▶  Window: When a 4:3 image is bigger than a 16:9 screen, select the "Window" mode to fit the image onto the screen without changing the projection distance.







❖ "Saturation", "Tint" and "Sharpness" function is not supported under DVI-D mode.



Discount-Merchant.com (800) 281-8860  
THE TRUSTED SOURCE FOR PROJECTOR LAMPS AND ACCESSORIES

## Video Mode

Language	Management	Lamp setting
Image-I	Image-II	Audio
Degamma	 <input type="text" value="50"/>	<input type="text" value="50"/>
Saturation	 <input type="text" value="50"/>	<input type="text" value="50"/>
Tint	 <input type="text" value="50"/>	<input type="text" value="50"/>
Sharpness	 <input type="text" value="50"/>	<input type="text" value="50"/>
Aspect Ratio	 <input type="text" value="16:9"/>	<input type="text" value="16:9"/>
16:9 Image Position		Press Enter to Set

## Image-II (Video Mode)



Original Pixel



Window



### 16:9 Image Position

Adjust the image position to up or down, when you select the aspect ratio to 16:9.

- ▶ Press the ◀ to move the image down.
- ▶ Press the ▶ to move the image up.

# User Controls

## Computer/Video Mode

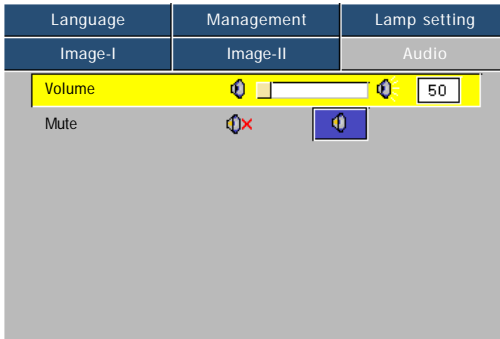

## Audio















### Volume

- ▶ Press the ◀ to decrease the volume.
- ▶ Press the ▶ to increase the volume.

### Mute

- ▶ Choose the left icon to turn mute on.
- ▶ Choose the right icon to turn mute off.

## Computer / Video Mode

Image-I	Image-II	Audio
Language	Management	Lamp setting
Menu Location	    	
Projection	   	
Signal Type	RGB	
Source Lock	On	
High Altitude		Off
Reset	Yes	

## Management

### Menu Location

Choose the Menu location on the display screen.

### Projection

- ▶  **Front-Desktop**

The factory default setting.

- ▶  **Rear-Desktop**

When you select this function, the projector reverses the image so you can project behind a translucent screen.

- ▶  **Front-Ceiling**

When you select this function, the projector turns the image upside down for ceiling-mounted projection.

- ▶  **Rear-Ceiling**

When you select this function, the projector reverses and turns the image upside down at same time. You can project from behind a translucent screen with ceiling mounted projection.

### Signal Type

Select signal type RGB or Video surces.

### Source Lock

When source lock is turned off, the projector will search for other signals if the current input signal is lost. When source lock is turned on, it will continue to search for the "lost signal" after "Source" is pressed.

# User Controls

## Computer / Video Mode

Image-I	Image-II	Audio
Language	Management	Lamp setting
Menu Location		
Projection		
Signal Type	RGB	<input type="button" value="Video"/>
Source Lock	On	<input type="button" value="Off"/>
High Altitude	<input type="button" value="On"/>	Off
Reset	Yes	<input type="button" value="No"/>

## Management

### High Altitude

Choose "ON" to turn on High Altitude mode operates the fans at full speed continuously to allow for proper high altitude cooling of the projector.

### Reset

Choose "Yes" to return the display parameters on all menus to the factory default settings.



**Discount-Merchant.com (800) 281-8860**  
THE TRUSTED SOURCE FOR PROJECTOR LAMPS AND ACCESSORIES

## Computer / Video Mode

Image-I	Image-II	Audio
Language	Management	Lamp setting
Lamp Hour	<input type="checkbox"/> <input type="checkbox"/>	<input type="text" value="50"/>
Lamp Reset	Yes <input type="checkbox"/> No <input type="checkbox"/>	
Lamp Reminding	Yes <input type="checkbox"/> No <input type="checkbox"/>	
ECO Mode	On <input type="checkbox"/> Off <input type="checkbox"/>	
Auto Power Off	<input type="checkbox"/> <input type="checkbox"/>	<input type="text" value="180"/>

## Lamp Setting

### Lamp Hour

Displays the lamp's elapsed operating time (in hours).

### Lamp Reset

Turns the lamp hour counter to 0 hours.

### Lamp Reminding

Choose this function to show or to hide the warning message when the changing lamp message is displayed. The message will show up 30 hours before end of life.

### ECO Mode

Choose "On" to dim the projector lamp which will lower power consumption and extend the lamp life by up to 130%. Choose "Off" to return normal mode.

### Auto Power Off

Set the interval of power off the system if there is no signal input. (In minutes)

## Troubleshooting

*If you experience trouble with the projector, refer to the following information. If the problem persists, please contact your local reseller or service center.*

### **Problem: No image appears on screen.**

- ▶ Ensure all the cables and power connections are correctly and securely connected as described in the “Installation” section.
- ▶ Ensure the pins of connectors are not crooked or broken.
- ▶ Check if the projection lamp has been securely installed. Please refer to the “Replacing the lamp” section.
- ▶ Make sure you have removed the lens cap and the projector is switched on.
- ▶ Ensure that the “Hide” feature is not enabled.

### **Problem: Partial, scrolling or incorrectly displayed image.**

- ▶ Press the “Re-Sync” button on the Remote Control or press the “Auto Image” button on the Control Panel.
- ▶ If you use a PC:  
If the resolution of your computer is higher than 1024 x 768.  
Follow the steps outlined below to reset the resolution.

For Windows 3.x:

1. In the Windows Program Manager, click the “Windows Setup” icon in the Main group.
2. Verify that your display resolution setting is less than or equal to 1024 x 768.

For Windows 95,98,2000,XP:

1. Open “My Computer” icon, the “Control Panel” folder, and then double click on the “Display” icon.
2. Select the “Setting” tab.
3. In the “Desktop Area” you will find the resolution setting.  
Verify that the resolution setting is less than or equal to 1024 x 768 resolution.

**If the projector is still not projecting the whole image, you will also need to change the monitor display you are using. Refer to the following steps.**

4. Follow the above steps 1-2. Click on the “Advanced Properties” button.
5. Select the “Change” button under the “Monitor” tab .

6. Click on “Show all devices”. Then select “Standard monitor types” under the “Manufacturers” box ; choose the resolution mode you need under the “Models” box.
  7. Verify that the resolution setting of the monitor display is less than or equal to 1024 x 768.
- ▶ If you are using a Notebook PC:
    1. You are required to implement the above steps of resolution setting of the computer first.
    2. Switch the Notebook PC display to the “external display only” or “CRT only” mode.
  - ▶ If you experience difficulty in changing resolutions or your monitor freezes, restart all the equipment and the projector.

**Problem: The screen of the Notebook or PowerBook computer is not displaying your presentation.**

- ▶ If you are using a Notebook PC:

Some Notebook PCs may deactivate their screens when a second display device is in use. Refer to your computer’s documentation for information on how to reactivate the monitor display.
- ▶ If you are using an Apple PowerBook:

In Control Panels, open the PowerBook Display to select Video Mirroring “On”.

**Problem: Image is unstable or flickering**

- ▶ Use “Tracking” to correct it. Refer to page 22.
- ▶ Change the monitor color setting from your computer.

**Problem: Image has vertical flickering bar**

- ▶ Use “Frequency” to make an adjustment. Refer to page 22.
- ▶ Check and reconfigure the display mode of your graphic card to make it compatible with the product. Refer to page 30.

**Problem: Image is out of focus**

- ▶ Adjusts the Focus Ring on the projector lens. Refer to page 14.
- ▶ Make sure the projection screen is between the required distance 3.9 to 32.8 feet (1.2 to 10.0 meters) from the projector.



# Appendices

## **Problem: The image is outstretched when displaying 16:9 DVD.**

The projector automatically detects 16:9 DVD and adjusts the aspect ratio by digitizing to full screen with 4:3 default setting.

If the image is still outstretched, you will also need to adjust the aspect ratio by referring to the following:

- ▶ Please select 4:3 aspect ratio type on your DVD player if you are playing a 16:9 DVD.
- ▶ If you can't select 4:3 aspect ratio type on your DVD player, please select 4:3 aspect ratio in the on screen menu.

## **Problem: Image is reversed.**

- ▶ Select "Management" from the OSD and adjust the projection direction. See page 27.

## **Problem: Lamp burns out or makes a popping sound**

- ▶ When the lamp reaches its end of life, it will burn out and may make a loud popping sound. If this happens, the projector will not turn on until the lamp module has been replaced. To replace the lamp, follow the procedures in the "Replacing the Lamp". See page 34.

## **Problem: LED lighting message**

Message	Power LED Green	Temp LED	Lamp LED
Standby State (Input power cord)	Flashing	○	○
Lamp lighting	☀	○	○
Power on	☀	○	○
Power off (Cooling)	☀	○	○
Error (Lamp fail)	○	○	☀
Error (Thermal fail)	☀	☀	○
Error (Fan lock fail)	○	Flashing	○
Error (Over Temp.)	○	☀	○
Error (Lamp Breakdown)	○	○	☀

# Appendices

## Problem: Message Reminders

- ▶ “Lamp is approaching the end of its useful life in full power operation. Replacement Suggested!” will be shown about 10 seconds when lamp life is going to deplete.
- ▶ “Projector Overheated. Lamp will automatically turn off soon.” will be shown when the system temperature is over heat.
- ▶ “Fan fail. Lamp will automatically turn off soon.” will be shown when the fan is out of order.



**Discount-Merchant.com (800) 281-8860**  
**THE TRUSTED SOURCE FOR PROJECTOR LAMPS AND ACCESSORIES**

# Appendices

## Replacing the lamp

The projector will detect the lamp life itself. It will show you a warning message "Lamp is approaching the end of its useful life in full power operation. Replacement Suggested!" When you see this message, changing the lamp as soon as possible.



**Warning:** Lamp compartment is hot! Allow it to cool down before changing lamp!

Make sure the projector has been cooled down for at least 30 minutes before changing the lamp.

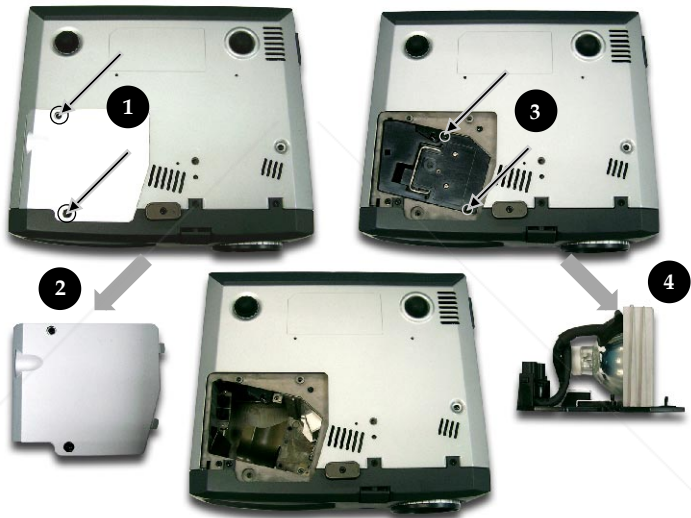

**Warning:** To reduce the risk of personal injury, do not drop the lamp module or touch the lamp bulb. The bulb may shatter and cause injury if it is dropped.

### Lamp Changing Procedure:

1. Turn the power off the projector by pressing the Power button.
2. Allow the projector to cool down at least 30 minutes.
3. Disconnect the power cord.
4. Use a screwdriver to remove the screw from the cover. **1**
5. Push up and remove the cover. **2**
6. Remove the 2 screws from the lamp module. **3**
7. Pull out the lamp module. **4**

To replace the lamp module, reverse the previous steps.

## Compatibility Modes

Mode	Resolution	(ANALOG)		(DIGITAL)	
		V.Frequency (Hz)	H.Frequency (kHz)	V.Frequency (Hz)	H.Frequency (kHz)
VESA VGA	640 x 350	70	31.5	70	31.5
VESA VGA	640 x 350	85	37.9	85	37.9
VESA VGA	640 x 400	85	37.9	--	--
VESA VGA	640 x 480	60	31.5	60	31.5
VESA VGA	640 x 480	72	37.9	72	37.9
VESA VGA	640 x 480	75	37.5	75	37.5
VESA VGA	640 x 480	85	43.3	85	43.3
VESA VGA	720 x 400	70	31.5	70	31.5
VESA VGA	720 x 400	85	37.9	85	37.9
SVGA	800 x 600	56	35.2	56	35.2
SVGA	800 x 600	60	37.9	60	37.9
SVGA	800 x 600	72	48.1	72	48.1
SVGA	800 x 600	75	46.9	75	46.9
SVGA	800 x 600	85	53.7	85	53.7
VESA XGA	1024 x 768	60	48.4	60	48.4
VESA XGA	1024 x 768	70	56.5	70	56.5
VESA XGA	1024 x 768	75	60.0	75	60.0
VESA XGA	1024 x 768	85	68.7	85	68.7
* VESA SXGA	1152 x 864	70	63.8	-	-
* VESA SXGA	1152 x 864	75	67.5	-	-
* VESA SXGA	1152 x 864	85	77.1	-	-
* VESA SXGA	1280 x 1024	60	63.98	60	63.98
* VESA SXGA	1280 x 1024	75	79.98	-	-
* VESA SXGA+	1400 x 1050	60	63.98	-	-
MAC LC 13"	640 x 480	66.66	34.98	-	-
MAC II 13"	640 x 480	66.68	35	-	-
MAC 16"	832 x 624	74.55	49.725	-	-
MAC 19"	1024 x 768	75	60.24	-	-
* MAC	1152 x 870	75.06	68.68	-	-
MAC G4	640 x 480	60	31.35	-	-
i Mac DV	1024 x 768	75	60	-	-
* i Mac DV	1152 x 870	75	68.49	-	-
* i Mac DV	1280 x 960	75	75	-	-



**Remark :** "x"  
compressed computer image.

## Ceiling Mount Installation

1. To prevent damaging your projector, please use the ceiling mount package for installation.
2. If you wish to use a third party ceiling mount kit, please ensure the screws used to attached a mount to the projector met the following specifications:

- ▶ **Screw type: M2.6**
- ▶ **Maximum screw length: 10mm**
- ▶ **Minimum screw length: 8mm**



❖ Please note that damage resulting from incorrect installation will invalidate the warranty.

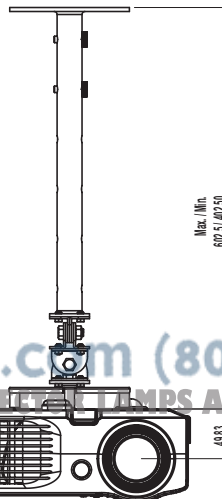
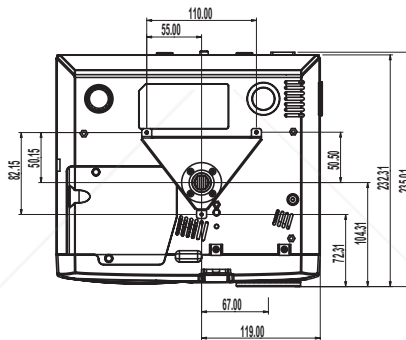

Discount-Merchant.com (800) 281-8860  
THE TRUSTED SOURCE FOR PROJECTOR LAMP AND ACCESSORIES



# Disclaimer

This user manual is provided as a free service by FixYourDLP.com. FixYourDLP is in no way responsible for the content of this manual, nor do we guarantee its accuracy. FixYourDLP does not make any claim of copyright and all copyrights remain the property of their respective owners.

About FixYourDLP.com

FixYourDLP.com (<http://www.fixyourdlp.com>) is the World's #1 resource for media product news, reviews, do-it-yourself guides, and manuals.

Informational Blog: <http://www.fixyourdlp.com>

Video Guides: <http://www.fixyourdlp.com/guides>

User Forums: <http://www.fixyourdlp.com/forum>

FixYourDLP's Fight Against Counterfeit Lamps:

<http://www.fixyourdlp.com/counterfeits>

## Sponsors:

RecycleYourLamp.org – Free lamp recycling services for used lamps:

<http://www.recycleyourlamp.org>

Lamp Research - The trusted 3rd party lamp research company:

<http://www.lampresearch.com>

Discount-Merchant.com – The worlds largest lamp distributor:

<http://www.discount-merchant.com>



**FixYourDLP.com**

Sponsored by 