



# Disclaimer

This user manual is provided as a free service by FixYourDLP.com. FixYourDLP is in no way responsible for the content of this manual, nor do we guarantee its accuracy. FixYourDLP does not make any claim of copyright and all copyrights remain the property of their respective owners.

About FixYourDLP.com

FixYourDLP.com (<http://www.fixyourdlp.com>) is the World's #1 resource for media product news, reviews, do-it-yourself guides, and manuals.

Informational Blog: <http://www.fixyourdlp.com>

Video Guides: <http://www.fixyourdlp.com/guides>

User Forums: <http://www.fixyourdlp.com/forum>

FixYourDLP's Fight Against Counterfeit Lamps:

<http://www.fixyourdlp.com/counterfeits>

## Sponsors:

RecycleYourLamp.org – Free lamp recycling services for used lamps:

<http://www.recycleyourlamp.org>

Lamp Research - The trusted 3rd party lamp research company:

<http://www.lampresearch.com>

Discount-Merchant.com – The worlds largest lamp distributor:

<http://www.discount-merchant.com>



**FixYourDLP.com**

Sponsored by 

## **FCC Notice**

This equipment has been tested and found to comply with the limits for a Class B digital device, pursuant to part 15 of the FCC Rules. These limits are designed to provide reasonable protection against harmful interference in residential installation. This equipment generates, uses and can radiate radio frequency energy and if not installed and used in accordance with the instructions, may cause harmful interference to radio communications. However, there is no guarantee that interference will not occur in a particular installation. If this equipment does cause harmful interference to radio or television reception, detectable by turning the equipment in question off and on, the user is encouraged to try to correct the interference by one or more of the following measures:

- Reorient or relocate the receiving antenna
- Increase the distance between the equipment and the receiver
- Connect the equipment to an outlet on a different circuit than that which the receiver is connected to
- Or consult the dealer or an experienced radio/TV technician for help.

This device complies with Part 15 of the FCC Rules. Operation is subject to following two conditions:

1. This device may not cause harmful interference, and
2. This device must accept any interference that may cause undesired operation.



**Discount-Merchant.com (800) 281-8860**  
**THE TRUSTED SOURCE FOR PROJECTOR LAMPS AND ACCESSORIES**

## Safety Instructions

Read all of these instructions before you operate your projector and save for future reference.

- 1. Read instructions**

All the safety and operating instructions should be read before the appliance is operated.

---
- 2. Notes and warnings**

All notes and warnings in the operating instructions should be adhered to.

---
- 3. Cleaning**

Unplug the projector from the wall socket before cleaning. Use a damp cloth for cleaning the projector housing. Do not use liquid or aerosol cleaners.

---
- 4. Accessories**

Do not place this product on an unstable cart, stand, or table. The product may fall, causing serious damage to the product.  
Keep the plastic packing materials (from the projector, accessories and optional parts) out of the reach of children as these bags may result in death by suffocation. Be particularly careful around the small children.

---
- 5. Ventilation**

The projector is equipped with ventilation holes (intake) and ventilation holes (exhaust). Do not block or place anything near these slots, or internal heat build-up may occur, causing picture degradation or damage to the projector.

---
- 6. Power sources**

Check that the operating voltage of your unit is identical with the voltage of your local power supply.

---
- 7. Servicing**

Do not attempt to service this projector yourself. Refer all servicing to qualified service personnel.

---
- 8. Replacement parts**

When replacement parts are required, be sure that the replacement parts are specified by the manufacture. Unauthorized substitutions may result in fire, electric shock or other hazards.

---
- 9. Moisture Condensation**

Never operate this projector immediately after moving it from a cold location to a warm one. When the projector is exposed to such a change in temperature, moisture may condense on the lens and the crucial internal parts. To prevent the unit from possible damage, do not use the projector for at least 2 hours when there is an extreme or sudden change in temperature.

---

## Notes on the AC Power Cord

AC Power Cord must meet the requirement of countries where you use this projector. Please confirm your AC plug type with the graphics below and ensure that the proper AC Power Cord is used. If the supplied AC Power Cord does not match your AC outlet, please contact your sales dealer. This projector is equipped with a grounding type AC line plug. Please ensure that your outlet fits the plug. Do not defeat the safety purpose of this grounding type plug. We highly recommend using a video source device also equipped with a grounding type AC line plug to prevent signal interference due to voltage fluctuations.

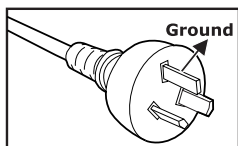

For Australia and  
Mainland China

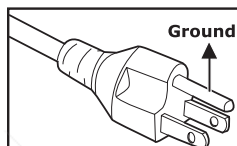

For the U.S.A. and Canada

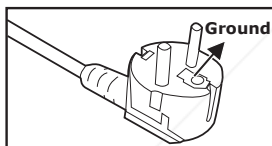

For Continental Europe

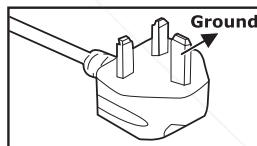

For the U.K.

# CONTENTS

<b>Introduction .....</b>	<b>5</b>
Projector Features .....	5
Package Contents .....	6
Projector Overview .....	7
<b>Using the Product.....</b>	<b>9</b>
Control Panel .....	9
Connection Ports.....	10
Remote Control.....	11
Replacing the Battery .....	12
Remote Control Operation .....	13
<b>Installation .....</b>	<b>14</b>
Connecting the Projector.....	14
Powering On/Off the Projector .....	15
Adjusting the Projector .....	16
<b>Menu Operation .....</b>	<b>18</b>
<b>Maintenance.....</b>	<b>22</b>
Cleaning the Lens .....	22
Cleaning the Projector Housing .....	22
Replacing the Lamp .....	23
<b>Specifications .....</b>	<b>25</b>
<b>Appendix.....</b>	<b>26</b>
LED Indicator Messages .....	26
Compatibility Modes.....	27
Troubleshooting .....	28



**Discount-Merchant.com (800) 281-8860**

**THE TRUSTED SOURCE FOR PROJECTOR LAMPS AND ACCESSORIES**

# Introduction

## Projector Features

The projector integrates high-performance optical engine projection and a user - friendly design to deliver high reliability and ease of use.

The projector offers the following features:

- Single chip 0.55" Texas Instruments DLP® technology
- XGA (1024 x 768 pixels)
- Auto image re-sizing (Auto-Sync.) to 1024 x 768 full screen with scaling compression compatibility for VGA, SVGA, XGA and SXGA\*
- Compatibility with Macintosh® computers
- Compatibility with NTSC, PAL, SECAM and HDTV
- D-Sub 15-pin terminal for analog video connectivity
- User-friendly, multi-language on-screen display
- Advanced electronic keystone correction



**NOTE**

\* means compressed.



**Discount-Merchant.com (800) 281-8860**  
**THE TRUSTED SOURCE FOR PROJECTOR LAMPS AND ACCESSORIES**

## Package Contents

When you unpack the projector, make sure you have all these components:

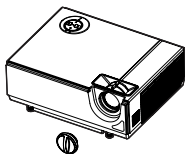

Projector with Lens Cap

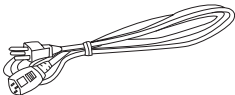

AC Power Cord

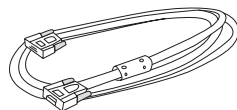

VGA Cable (D-SUB to D-SUB)

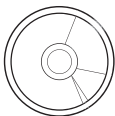

User Manual CD

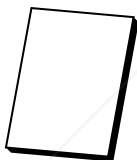

Quick Start Guide



Remote Control (IR)

### NOTE

- Contact your dealer immediately if any items are missing, appear damaged, or if the unit does not work.



### Caution

- Avoid using the projector in a dust environment.
- Leave the power cable plugged in for 5-10 minutes until the projector adjusts to room temperature before using.
- Save the original shipping carton and packing material; they will come in handy if you ever need to ship your unit. For maximum protection, repackage your unit as it was originally packed at the factory.



**Discount-Merchant.com (800) 281-8860**  
THE TRUSTED SOURCE FOR PROJECTOR LAMPS AND ACCESSORIES

# Projector Overview

## Front View

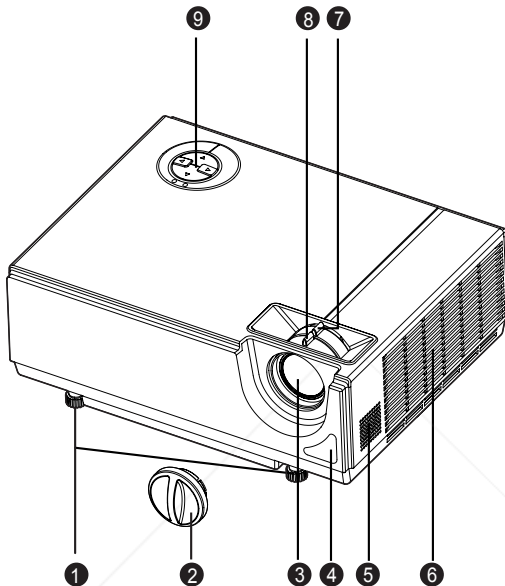

- |   |                                |   |                             |
|---|--------------------------------|---|-----------------------------|
| 1 | Tilt-adjustment feet           | 6 | Ventilation holes ((intake) |
| 2 | Lens cap                       | 7 | Zoom ring                   |
| 3 | Projection lens                | 8 | Focus ring                  |
| 4 | Front IR remote control sensor | 9 | Control panel               |
| 5 | Speaker                        |   |                             |

### Caution

- Do not touch the lamp cover and exhaust vents during projector usage to prevent from possible burning.
- Do not looking into the lens or vents while the lamp is on. Strong light ray may be harmful to eyes.
- Do not carry the projector by solely handling the adjustment feet. Projector may drop and be damaged.



## Rear View

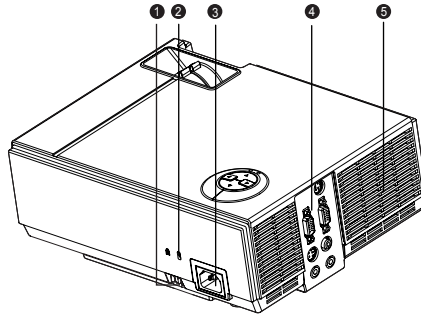

- ❶ Security lock
- ❷ Kensington lock
- ❸ AC power socket
- ❹ Connection ports
- ❺ Ventilation holes (exhaust)

## Bottom View

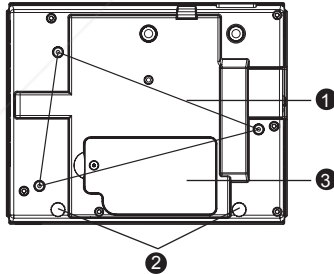

- ❶ Ceiling mount
- ❷ Tilt-adjustment feet
- ❸ Lamp cover



FixYourDLP.com

Sponsored by

NOTE

■ This projector can be used with a ceiling mount for support. The ceiling mount is not included in the package.

■ Contact your dealer for information to mount the projector on a ceiling.

Discount-4-All.com (800) 281-8860  
THE TRUSTED SOURCE FOR PROJECTOR LAMPS AND ACCESSORIES

# Using the Product

## Control Panel

### LED

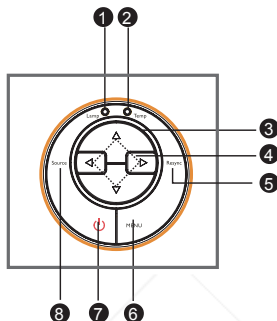

- 1 **Lamp** (Lamp LED indicator)  
Refer to “LED Indicator Messages”.
- 2 **Temp** (Temperature LED indicator)  
Refer to “LED Indicator Messages”.
- 3 **Power LED**  
Refer to “LED Indicator Messages”.

### Button Function

- 4 **Four directional buttons**  
Use four directional buttons to select items or make adjustments to your selection.
- 5 **Resync**  
Resynchronize the projector to the input signal from a computer.
- 6 **MENU**
  - Display or exit the on-screen display menus.
  - Enter to sub-menu and confirm the menu selection. Activate in Color Setting, Lamp Hours Reset and Factory Default menu operations.
- 7 **(Power)**  
Turn the projector on or off.
- 8 **Source**  
Manually select an input source.

## Connection Ports

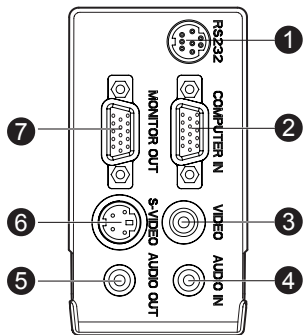

- 1 RS232**  
Reserved for installation control and firmware upgrades.
- 2 COMPUTER IN**  
Connect image input signal (analog RGB or component) to this jack.
- 3 VIDEO**  
Connect composite video output from video equipment to this jack.
- 4 AUDIO IN**  
Connect an audio output from video equipment to this jack.
- 5 AUDIO OUT**  
Connect to a speaker or other audio input equipment.
- 6 S-VIDEO**  
Connect S-Video output from video equipment to this jack.
- 7 MONITOR OUT**  
Connect to a computer display, etc.



**Discount-Merchant.com (800) 281-8860**  
**THE TRUSTED SOURCE FOR PROJECTOR LAMPS AND ACCESSORIES**

## Remote Control

- 1 POWER**  
Turn the projector on or off.
- 2 Four directional buttons**  
Use four directional buttons to select items or make adjustments to your selection.
- 3 MENU**  
Display or exit the on-screen display menus.
- 4 RESYNC**  
Resynchronize the projector to the input signal from a computer.
- 5 SOURCE**  
Manually select an input source.
- 6 Brilliant Color**  
Produce an expanded on-screen color spectrum that delivers enhanced color saturation for bright, true-to-life images. Activate this function for most computer sources.
- 7 BLANK**  
Cut off the screen temporarily. Press again to cancel the blank function.
- 8 ASPECT**  
Press this button to switch the image aspect ratio from 4:3 to 16:9.

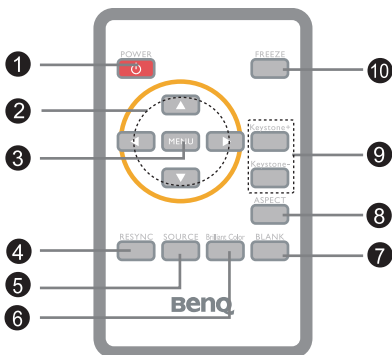

- 9 Keystone+ / -**  
Adjust image distortion caused by tilting the projector.
- 10 FREEZE**  
Press "FREEZE" to pause the screen image. Press again to cancel the freeze function.

## Replacing the Battery

### For the first time use:

Remove the transparent insulation tape by pulling it before use.

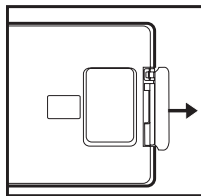

### For battery change:

1. Push the catch to the left and remove the battery holder.
2. Remove the old Lithium coin cell and install new one (CR2025). Ensure that the side with the mark "+" is up.
3. Push the battery holder back into the remote control until you feel a click.

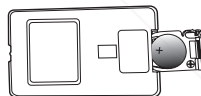
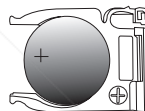
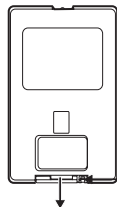

### Caution

- Risk of explosion if battery is replaced by an incorrect type.
- Dispose of used batteries according to the instructions.
- Make sure the plus and minus terminals are correctly aligned when loading a battery.

- *Keep the battery out of the reach of children.*
- *Do not recharge the battery or expose the battery to fire or water.*
- *Do not dispose the used battery along with household waste. Dispose used batteries according to local regulations.*
- *Danger of explosion may happen if batteries are incorrectly replaced. Replace only with the same type recommended by the manufacturer.*
- *Battery should not be in or near to fire or water, keep batteries in a dark, cool and dry place.*
- *If suspect battery leakage, wipe out the leakage and then replace a new battery. If the leakage adheres to your body or clothes, rinse well with water immediately.*



Discount-Furniture.com (800) 281-8860  
THE TRUSTED SOURCE FOR FURNITURE PARTS

## Remote Control Operation

Point the remote control at the infrared remote sensor and press a button.

- Operating the projector from the front

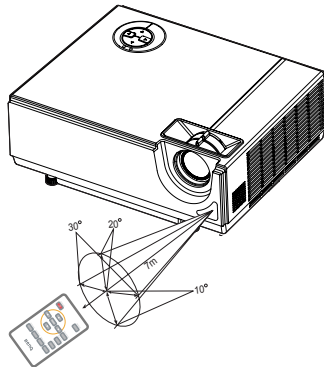

- *The remote control may not operate when there is sunlight or other strong light such as a fluorescent lamp shining on the remote sensor.*
- *Operate the remote control from a position where the remote sensor is visible.*
- *Do not drop the remote control or jolt it.*
- *Keep the remote control out of locations with excessively high temperature or humidity.*
- *Do not get water on the remote control or place wet objects on it.*
- *Do not disassemble the remote control.*



**Discount-Merchant.com (800) 281-8860**  
**THE TRUSTED SOURCE FOR PROJECTOR LAMPS AND ACCESSORIES**

# Installation

## Connecting the Projector

- 1 RS-232 Cable
- 2 VGA Cable (D-Sub to D-Sub)
- 3 Composite Video Cable
- 4 Audio Cable
- 5 S-Video Cable
- 6 VGA (D-Sub) to HDTV (RCA) Cable

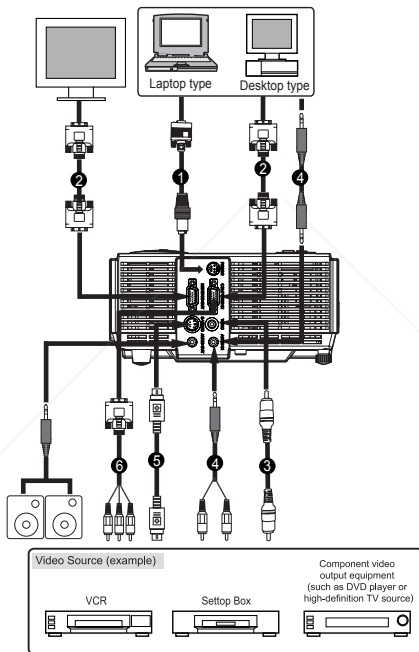

When connecting cable, power cords of both projector and external equipment should be disconnected from AC outlet.

The figure above is a sample connection. This does not mean that all of these devices can or must be connected simultaneously.

The cables that come with the projector may differ from the above illustration. The included cables are based on actual shipment delivery.

## Powering On/Off the Projector

### Powering On the Projector:



1. Remove the projector lens cap.
2. Complete the AC power cord and peripheral signal cable(s) connections.
3. Press  button on the control panel or the **POWER** button on the remote control to turn on the projector.  
The projector takes a minute or so to warm up.
4. Turn on your source (computer, notebook, DVD, etc.). The projector automatically detects your source.
  - If you are connecting multiple sources to the projector simultaneously, press the left button on the control panel or the Source button on the remote control.



#### Warning

- Remove the lens cap first before powering on.
- Never look into the lens when the lamp is on. This can damage your eyes.
- This focal point concentrates high temperature. Do not place any object near it to avoid possible fire hazard.

### Powering Off the Projector:

1. Press  button on the control panel or the **POWER** button on the remote control to turn off the projector lamp. You will see a message "Power off? Press Power again" appear on the screen.
2. Press  button on the control panel or the **POWER** button on the remote control again to confirm.
  - The cooling fans continue to operate for cooling cycle.
  - When the Lamp LED begins flashing, the projector has entered stand-by mode.
  - If you want to turn the projector back on, you must wait until the projector has completed the cooling cycle and has entered stand-by mode. Once in stand-by mode, simply press  button on the control panel or the **POWER** button on the remote control to restart the projector.
3. Disconnect the AC power cord from the electrical outlet and the projector.
4. Do not turn on the projector right after power off.



**Discount-Merchant.com (800) 281-8860**  
**THE TRUSTED SOURCE FOR PROJECTOR LAMPS AND ACCESSORIES**



## Adjusting the Projector

### Adjusting the Projector Height

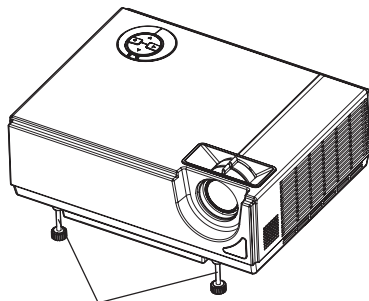

Tilt-adjustment feet

The projector is equipped with two tilt-adjustment feet to adjust the image height. To level the image on the screen, turn the tilt-adjustment feet to fine-tune the height.

#### NOTE

- To avoid damaging the projector, make sure that the tilt-adjustment feet are fully retracted before placing the projector in its carrying case.

### Adjusting the Projector Zoom and Focus

Zoom ring

Focus ring

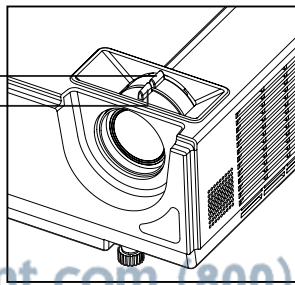

1. Focus the image by rotating the focus ring. A still image is recommended for focusing.
2. Adjust the image by sliding the zoom ring.

## Adjusting Projection Image Size

Refer to the graphic and table below to determine the screen size and projection distance.

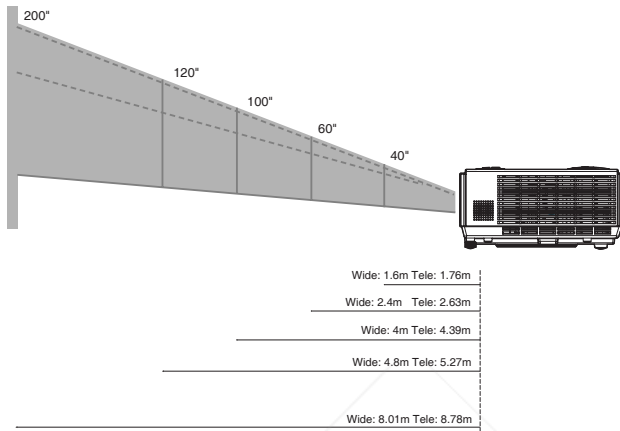

Screen Size Diagonal (Inch)	4 : 3 Screen			
	Wide		Tele	
	Projection Distance		Projection Distance	
	m	inch	m	inch
40	1.60	63.04	1.76	69.12
50	2.00	78.80	2.19	86.40
60	2.40	94.56	2.63	103.68
70	2.80	110.32	3.07	120.96
80	3.20	126.08	3.51	138.24
90	3.60	141.84	3.95	155.52
100	4.00	157.60	4.39	172.80
120	4.80	189.12	5.27	207.36
150	6.00	236.40	6.58	259.20
200	8.01	315.20	8.78	345.60
250	10.01	394.00	10.97	432.00
300	12.01	472.80	13.17	518.40



- Position the projector in a horizontal position; other positions can cause heat build-up and damage to the projector.
- Keep a space of 30 cm or more between the sides of the projector.
- Do not use the projector in a smoky environment. Smoke residue may build-up on critical parts and damage the projector or its performance.
- Consult with your dealer for special installation such as suspending from a ceiling.

# Menu Operation

The projector has multilingual on-screen display menus that allow you to make image adjustments and change a variety of settings.

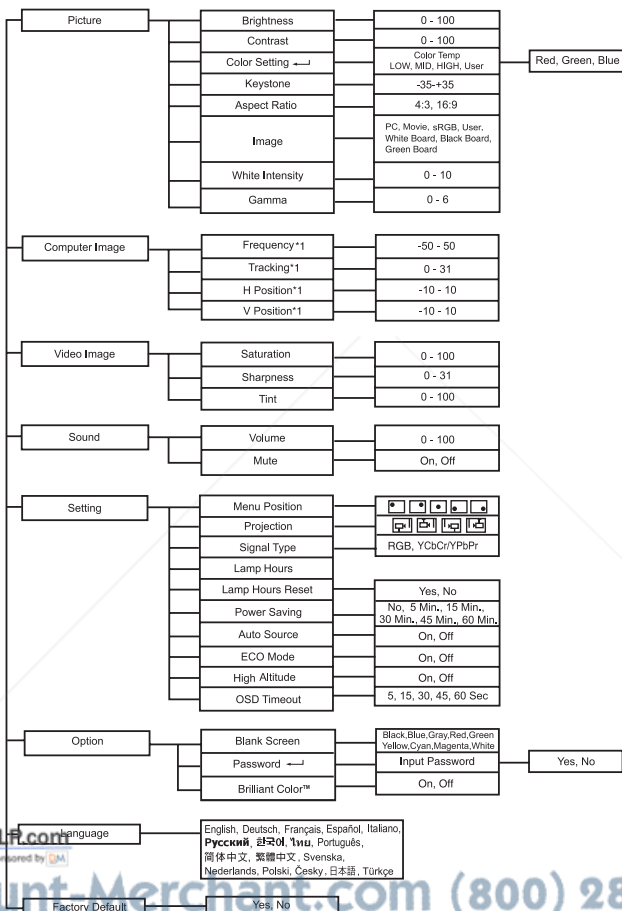

\*1 Adjustable range and default setting vary depending on signal type.

## How to operate

1. Press the **MENU** button to open the OSD menu.
2. When OSD is displayed, use **▲ / ▼** to select any feature in the main menu.
3. After selecting the desired main menu feature, press **▶** to enter sub-menu for feature setting.
4. Adjust the settings with **◀ / ▶**.
5. Press the **MENU** button, the screen will return to the main menu.
6. To exit OSD, press the **MENU** button again. The OSD menu will close and the projector will automatically save the new settings.

## Picture (Computer / Video Mode)

### Brightness

Brighten or darken the image.

### Contrast

Set the difference between light and dark areas.

### Color Setting

Adjust the color temperature. At higher temperature the screen looks colder; at lower temperature, the screen looks warmer. If you select "User", then you can change the intensity of each of 3 color (Red,Green,Blue) to customize user color temperature.

### Keystone

Correct the keystone distortion.

### Aspect Ratio

Select how the picture fits on the screen:

- 4:3 : The input source will be scaled to fit the projection screen.
- 16:9 : The input source will be scaled to fit the width of the screen.

### Image

There are many factory presets optimized for various types of images.

- PC : For computer or notebook.
- Movie : For home theater.
- sRGB : For PC standard color.
- User : Memorize user's settings.
- White Board : For white projection screen type.
- Black Board : For black projection screen type.
- Green Board: For green projection screen type.

### White Intensity

Increase the brightness of white areas.

### Gamma

Effect the represent of dark scenery. With greater gamma value, dark scenery will look brighter.

### Computer Image (Computer Mode)

Frequency



FixYa.com

Discount-Merchant.com (800) 281-8860

THE TRUSTED SOURCE FOR PROJECTOR LAMPS AND ACCESSORIES

Adjust the timing of the projector relative to the computer.

#### **Tracking**

Adjust the phase of the projector relative to the computer.

#### **H Position (Horizontal Position)**

Adjust the image left or right within the projection area.

#### **V Position (Vertical Position)**

Adjust the image up or down within the projection area.

### **Video Image (Video Mode)**

#### **Saturation**

Adjust a video image from black and white to fully saturated color.

#### **Sharpness**

Sharpen or soften the image.

#### **Tint**

Shift colors toward red or green.

### **Sound (Computer / Video Mode)**

#### **Volume**

Adjust the volume level.

#### **Mute**

Mute the sound.

### **Setting (Computer / Video Mode)**

#### **Menu Position**

Choose the menu location on the display screen.

#### **Projection**

Adjust the picture to match the orientation of the projector: upright or upside-down, in front of or behind the screen. Invert or reverse the image accordingly.

#### **Signal Type**

Specify the source to the Computer In terminal that you wish to project.

- RGB: For VGA signal
- YCbCr/YPbPr: For Component I, P signal

#### **Lamp Hours**

Display the lamp's elapsed operating time (in hours).

#### **Lamp Hours Reset**

Reset the lamp Hour to 0 hours.

#### **Power Saving**

If no operation is performed for a specific period of time, projector will automatically turn off.

**Auto Source**

Automatically scan through all the input source.

**ECO Mode**

Use this function to dim the projector lamp light output which will lower power consumption and increase lamp life.

**High Altitude**

Use this function to allow the fans operates at full speed continuously to achieve proper high altitude cooling of the projector.

**OSD Timeout**

Duration of OSD menu display countly starts (at idle state by second).

**Option (Computer / Video Mode)****Blank Screen**

Blank the screen temporarily, and select the screen color when this function is active.

**Password**

Set or change the password. When the password function is added, image projection will require to input the preset password when turning on the projector.

**Brilliant Color™**

Produce an expanded on-screen color spectrum that delivers enhanced color saturation for bright, true-to-life images. Suggesting to turn Off for most video sources and On for most computer sources.

**Language (Computer / Video Mode)**

Select the language used by the on-screen menu.

**Factory Default (Computer / Video Mode)**

Restore settings to factory default .



**Discount-Merchant.com (800) 281-8860**  
**THE TRUSTED SOURCE FOR PROJECTOR LAMPS AND ACCESSORIES**

# Maintenance

The projector needs proper maintenance. You should keep the lens clean as dust, dirt or spots will project on the screen and diminish image quality. If any other parts need replacing, contact your dealer or qualified service personnel. When cleaning any part of the projector, always switch off and unplug the projector first.



## Warning

Never open any of the covers on the projector. Dangerous electrical voltages inside the projector can cause severe injury. Do not attempt to repair this product by yourself. Refer all servicing to qualified service personnel.

## Cleaning the Lens

Gently wipe the lens with lens cleaning paper. Do not touch the lens with your hands.

## Cleaning the Projector Housing

Gently wipe with a soft cloth. If dirt and stains are not easily removed, use a soft cloth dampened with water, or water and neutral detergent, and wipe dry with a soft, dry cloth.



- *Turn off the projector and remove the AC power cord from the power outlet before beginning maintenance work.*
- *Make sure the lens is cool before cleaning.*
- *Do not use detergents or chemicals other than those noted above. Do not use benzene or thinners.*
- *Do not use chemical sprays.*
- *Use a soft cloth or lens paper only.*

## Replacing the Lamp

As the projector operates over time, the brightness of the projector lamp gradually decreases and the lamp becomes more susceptible to breakage. We recommend replacing the lamp if a warning message is displayed. Do not attempt to replace the lamp yourself. Contact the qualified service personnel for replacement.



- *The lamp is extremely hot right after turning off the projector. If you touch the lamp, you may scald your finger. When you replace the lamp, wait for at least 45 minutes for the lamp to cool down.*
- *Do not touch the lamp glass at any time. The lamp may explode due to improper handling, including the touching of the lamp glass.*
- *Lamp lifetime may differ from lamp to lamp and according to the environment of use. There is no guarantee of the same lifetime for each lamp. Some lamps may fail or terminate their lifetime in a shorter period of time than other similar lamps.*
- *A lamp may explode as a result of vibration, shock or degradation as a result of hours of use as its lifetime draws to an end. Risk of explosion may differ according to the environment or conditions in which the projector and lamp are being used.*
- *Wear protective gloves and eyeglasses when fixing or detaching the lamp.*
- *Faster on-off-cycles will damage the lamp and reduce lamp life. Wait at least for 5 minutes to turn off the projector after powering on.*
- *Do not operate the lamp in proximity to paper, cloth, or other combustible material nor cover it with such materials.*
- *Do not operate the lamp in an atmosphere containing an inflammable substance, such as thinner.*
- *Thoroughly ventilate the area or the room when operating the lamp in an oxygen atmosphere (in the air). If ozone is inhaled, it could cause headaches, nausea, dizziness, and other symptoms.*
- *The inorganic mercury is involved in the lamp. If the lamp bursts, the mercury inside the lamp will be exposed. Leave the area immediately if the lamp shatters while being operated and ventilate the area for at least 30 minutes in order to avoid the inhalation of mercury fumes. Otherwise it could be harmful to user's health.*



1. Turn off the projector.
2. Unplug the power cord.
  - If the projector is installed in a ceiling mount, remove it from the mount. Place a protective sheet (cloth) beneath the projector. Turn the projector over so you can access the lamp cover.
3. Loosen the screw in the lamp cover and remove the cover.
4. Loosen the two screws from the lamp module.
5. Pull up the handle, and then pull out the lamp unit by the handle.
6. Insert a new lamp module into the projector and tighten the screws.
7. Replace the lamp cover and tighten the screw.
8. Turn on the projector. If the lamp does not turn on after the warm-up period, try reinstalling the lamp.
9. Reset the lamp hour. Refer to the Setting (Computer / Video Mode) menu.

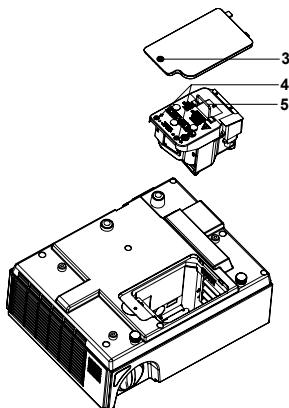

- *Dispose the used lamp according to local regulations.*
- *Ensure that screws are tightened properly. Screws not tightened fully may result in injury or accidents.*
- *Since the lamp is made of glass, do not drop the unit and do not scratch the glass.*
- *Do not reuse the old lamp. This could cause the lamp to explode.*
- *Be sure to turn off the projector and unplug the AC power cord before replacing the lamp.*
- *Do not use the projector with the lamp cover removed.*

# Specifications

Display Type	Single 0.55" DLP panel
Resolution (Pixels)	XGA (1024 × 768)
Brightness	2000 ANSI Lumens
Lens	Manual Zoom (1.1x)
Screen Size	30" – 300"
Lamp	180W
Input Source	D-Sub 15 pin, composite video, RS232, Audio input (stereo phone jack), S-video
Output Source	Audio output (stereo phone jack), D-Sub 15 pin
Video Compatibility	NTSC 3.58, NTSC4.43 PAL-60, M, N SECAM, HDTV (480i/p, 576i/p, 720p, 1080i)
Scanning Frequency	
Horizontal Freq.	31 - 79 KHz
Vertical Freq.	50 - 85 Hz
Speaker	2W x 1
Environment	Operating: Temperature: 5°C to 35°C Humidity: 30%-80% Storage: Temperature: -20°C to 60°C Humidity: 30%-85%
Power Requirement	AC 100 - 240 V, 50 - 60 Hz, 2.5A
Power Consumption	240 W
Dimension (W x D x H)	274 x 216 x 105 mm
Weight	2.4 kg (5.3lb)

Note: Design and Specifications are subject to change without prior notice.



**Discount-Merchant.com (800) 281-8860**  
**THE TRUSTED SOURCE FOR PROJECTOR LAMPS AND ACCESSORIES**

# Appendix

## LED Indicator Messages

Lamp LED	Temp LED	Power LED	Meaning
Off	Off	100% blinking blue	Stand-by mode
Off	Off	Solid blue	The projector is in good condition. When the power button is pressed, the brightness is 100%. After 30 seconds, it turns into 20%.
Solid red	Solid red	20% solid blue	The projector is shutting and the fan is cooling the lamp for shutdown.
Solid red	Solid red	100% solid blue	The lamp is going to reach its end of lifetime and must be changed soon.
Solid red	Blinking red	20% solid blue	The fan has a breakdown.
Blinking red	Off	100% solid blue	Temperature is too high. The lamp will turn off. The fan is cooling the lamp.
Solid red	Solid red	Off	The lamp ignition failed.



**Discount-Merchant.com (800) 281-8860**  
**THE TRUSTED SOURCE FOR PROJECTOR LAMPS AND ACCESSORIES**

## Compatibility Modes

### Computer:

Compatibility	Resolution	H-Sync [KHz]	V-Sync [Hz]
VGA	640 x 480	31.5	59.9
		37.9	72.8
		37.5	75.0
		43.3	85.0
SVGA	800 x 600	35.2	56.3
		37.9	60.3
		48.1	72.2
		46.9	75.0
		53.7	85.1
XGA	1024 x 768	48.4	60.0
		56.5	70.1
		60.0	75.0
		68.7	85.0
SXGA	1152 x 864	67.5	75.0
	1280 x 960	60.0	60.0
	1280 x 1024	64.0	60.0

### Video:

Signal	Horizontal Frequency (kHz)	Vertical Frequency (Hz)
480i	15.8	60
480p	31.5	60
576i	15.6	50
576p	31.3	50
720p	45.0	60
720p	37.5	50
1080i	33.8	60
1080i	28.1	50



**Discount-Merchant.com (800) 281-8860**  
THE TRUSTED SOURCE FOR PROJECTOR LAMPS AND ACCESSORIES

## Troubleshooting

Refer to the symptoms and measures listed below before sending the projector for repairs. If the problem persists, contact your local reseller or service center. Please refer to "LED Indicator Messages" as well.

### Start-up problems

If no lights turn on:

- Be sure that the power cord is securely connected to the projector and the other end is plugged into an outlet with power.
- Press the power button again.
- Unplug the power cord and wait for a short while, then plug it in and press the power button again.

### Image problems

If the searching source is displayed:

- Press the **Source** button on the control panel or the **SOURCE** button on the remote control one or more times to select another active input source.
- Be sure the external source is turned on and connected.
- For a computer connection, ensure your notebook computer's external video port is turned on. Refer to the computer manual.

If the image is out of focus:

- Be sure the lens cover is removed.
- While displaying the on-screen menu, adjust the focus ring. (The image size should not change; if it does, you are adjusting the zoom, not the focus.)
- Check the projection lens to see if it needs cleaning.

If the image is flickering or unstable for a computer connection:

- Press the **Resync** button on the control panel or the **RESYNC** button on the remote control.
- Press the **MENU** button, go to **Computer Image** and adjust **Frequency** or **Tracking**.

### Remote control problems

If the remote control does not operate:

- Be sure nothing is blocking the remote control receiver on the front of the projector. Use the remote control within the effective range.
- Aim the remote control at the screen or at the front of the projector.
- Move the remote control so it is more directly in front of the projector and not as far to the side.



# Disclaimer

This user manual is provided as a free service by FixYourDLP.com. FixYourDLP is in no way responsible for the content of this manual, nor do we guarantee its accuracy. FixYourDLP does not make any claim of copyright and all copyrights remain the property of their respective owners.

About FixYourDLP.com

FixYourDLP.com (<http://www.fixyourdpl.com>) is the World's #1 resource for media product news, reviews, do-it-yourself guides, and manuals.

Informational Blog: <http://www.fixyourdpl.com>

Video Guides: <http://www.fixyourdpl.com/guides>

User Forums: <http://www.fixyourdpl.com/forum>

FixYourDLP's Fight Against Counterfeit Lamps:

<http://www.fixyourdpl.com/counterfeits>

## Sponsors:

RecycleYourLamp.org – Free lamp recycling services for used lamps:

<http://www.recycleyourlamp.org>

Lamp Research - The trusted 3rd party lamp research company:

<http://www.lampresearch.com>

Discount-Merchant.com – The worlds largest lamp distributor:

<http://www.discount-merchant.com>



**FixYourDLP.com**

Sponsored by 