



# Disclaimer

This user manual is provided as a free service by FixYourDLP.com. FixYourDLP is in no way responsible for the content of this manual, nor do we guarantee its accuracy. FixYourDLP does not make any claim of copyright and all copyrights remain the property of their respective owners.

About FixYourDLP.com

FixYourDLP.com (<http://www.fixyourdpl.com>) is the World's #1 resource for media product news, reviews, do-it-yourself guides, and manuals.

Informational Blog: <http://www.fixyourdpl.com>

Video Guides: <http://www.fixyourdpl.com/guides>

User Forums: <http://www.fixyourdpl.com/forum>

FixYourDLP's Fight Against Counterfeit Lamps:

<http://www.fixyourdpl.com/counterfeits>

## Sponsors:

RecycleYourLamp.org – Free lamp recycling services for used lamps:

<http://www.recycleyourlamp.org>

Lamp Research - The trusted 3rd party lamp research company:

<http://www.lampresearch.com>

Discount-Merchant.com – The worlds largest lamp distributor:

<http://www.discount-merchant.com>



**FixYourDLP.com**

Sponsored by 

# TOSHIBA

## OWNER'S MANUAL

# PROJECTOR

---

**TDP-ET10**

**TDP-ET20** (with built-in DVD player)

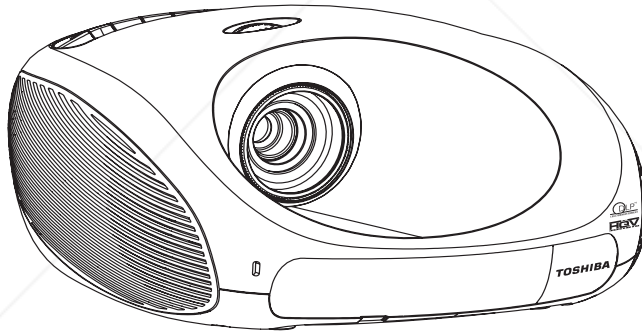

Before Using

Preparations

Operations

Maintenance

Others



**Discount-Merchant.com (800) 281-8800**  
THE TRUSTED SOURCE FOR PROJECTOR LAMPS AND ACCESSORIES

Model No. \_\_\_\_\_

Serial No. \_\_\_\_\_

# SAFETY PRECAUTIONS



The lightning flash with arrowhead symbol, within an equilateral triangle, is intended to alert the user to the presence of uninsulated “dangerous voltage” within the product’s enclosure that may be of sufficient magnitude to constitute a risk of electric shock to persons.



The exclamation point within an equilateral triangle is intended to alert the user to the presence of important operation and maintenance (servicing) instructions in the literature accompanying the appliance.

**WARNING:** TO REDUCE THE RISK OF FIRE OR ELECTRIC SHOCK, DO NOT EXPOSE THIS APPLIANCE TO RAIN OR MOISTURE. DANGEROUS HIGH VOLTAGES ARE PRESENT INSIDE THE ENCLOSURE. DO NOT OPEN THE CABINET. REFER SERVICING TO QUALIFIED PERSONNEL ONLY.

**WARNING:** Handling the cord on this product or cords associated with accessories sold with this product will expose you to lead, a chemical known to the State of California to cause birth defects or other reproductive harm.  
**USA only**  
*Wash hands after handling.*

**WARNING:** This product contains mercury. Disposal of mercury may be regulated due to environmental considerations. For disposal or recycling information, please contact your local authorities or the Electronic Industries Alliance: [www.eiae.org](http://www.eiae.org).  
**USA only**

**MODEL NAME: TDP-ET10, TDP-ET20** **USA only**

TRADE NAME: PROJECTOR      MODEL NAME: TDP-ET10, TDP-ET20

**FC** Tested to Comply  
With FCC Standards

FOR HOME OR OFFICE USE

**FCC NOTICE:** This device complies with part 15 of the FCC Rules. Operation is subject to the following two conditions:

(1) This device may not cause harmful interference, and (2) this device must accept any interference received, including interference that may cause undesired operation.

This equipment has been tested and found to comply with the limits for a Class B digital device, pursuant to part 15 of the FCC Rules. These limits are designed to provide reasonable protection against harmful interference in a residential installation. This equipment generates, uses and can radiate radio frequency energy and, if not installed and used in accordance with the instructions, may cause harmful interference to radio communications.

However, there is no guarantee that interference will not occur in a particular installation.

If this equipment does cause harmful interference to radio or television reception, which can be determined by turning the equipment off and on, the user is encouraged to try to correct the interference by one or more of the following measures:

- Reorient or relocate the receiving antenna.
- Increase the separation between the equipment and receiver.
- Connect the equipment into and outlet on a circuit different from that to which the receiver is connected.
- Consult the dealer or an experienced radio/TV technician for help.

RESPONSIBLE PARTY: TOSHIBA AMERICA INFORMATION SYSTEMS, INC.  
9740 Irvine Blvd., Irvine, CA 92618-1697, USA  
Phone: (949) 583-3000

**WARNING:** Changes or modifications made to this equipment not expressly approved by Toshiba, or parties authorized by Toshiba, could void the user's authority to operate the equipment.

**USA only**

**Notice** This Class B digital apparatus complies with Canadian ICES-003.

**CANADA only**

Cet appareil numérique de la classe B est conforme à la norme NMB-003 du Canada.



**Discount-Merchant.com (800) 281-8860**  
**THE TRUSTED SOURCE FOR PROJECTOR LAMPS AND ACCESSORIES**



# IMPORTANT SAFETY INSTRUCTIONS

**CAUTION: PLEASE READ AND OBSERVE ALL WARNINGS AND INSTRUCTIONS GIVEN IN THIS OWNER'S MANUAL AND THOSE MARKED ON THE UNIT. RETAIN THIS BOOKLET FOR FUTURE REFERENCE.**

This set has been designed and manufactured to assure personal safety. Improper use can result in electric shock or fire hazard. The safeguards incorporated in this unit will protect you if you observe the following procedures for installation, use and servicing. This unit is fully transistorized and does not contain any parts that can be repaired by the user.

**DO NOT REMOVE THE CABINET COVER OR YOU MAY BE EXPOSED TO DANGEROUS VOLTAGE. REFER SERVICING TO QUALIFIED SERVICE PERSONNEL ONLY.**

## 1. Read Owner's Manual

After unpacking this product, read the owner's manual carefully, follow all the operating instructions, and heed all warnings.

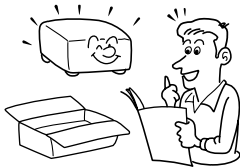

## 3. Source of Light

Do not look into the lens while the lamp is on. The strong light from the lamp may cause damage to your eyes or sight.

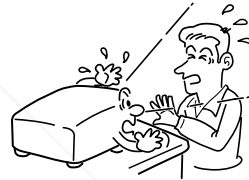

## 2. Power Sources

This product should be operated with only the type of power source indicated on the marking label. If you are not sure what type of power source is available to you, consult your product dealer and local power company. For products intended to operate with battery power or other power sources, refer to the operating instructions.



## 4. Ventilation

Place this product in a location with adequate ventilation to prevent heat build-up. Openings in the cabinet are provided for ventilation and must not be blocked or covered. Do not place this product on a bed, sofa, rug or other similar surfaces that may block the ventilation holes. This product should not be placed in a confined space or built-in installation such as a bookcase or rack unless proper ventilation is provided or the manufacturer's instructions have been adhered to.



FixYourDLP.com  
Sponsored by DM

Discount-Merchant.com 800-991-8860  
THE TRUSTED SOURCE FOR PROJECTOR LAMPS AND ACCESSORIES

### 5. Heat

The product should be situated away from heat sources such as radiators, heat registers, stoves, or other products (including amplifiers) that produce heat.

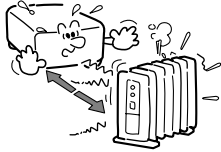

### 8. Power-Cord Protection

Power-supply cords should be routed so that they are not likely to be walked on or pinched by items placed upon or against them, paying particular attention to cords at plugs, convenience receptacles, and the point where they exit from the product.



### 6. Water and Moisture

Do not place this product near water such as a bathtub, washbowl, kitchen sink, laundry tub, or in a wet basement, near a swimming pool and the like. Do not place objects filled with liquids, such as vases or cups, near or on the product.

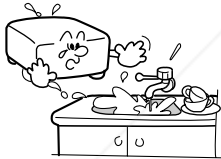

### 9. Overloading

Do not overload wall outlets, extension cords, or integral convenience receptacles as this can result in a risk of fire or electric shock.



### 7. Cleaning

Unplug this product from the wall outlet before cleaning. Do not use liquid cleaners or aerosol cleaners. Use a soft cloth for cleaning.



# IMPORTANT SAFETY INSTRUCTIONS (Continued)

## 10. Lightning storms

For added protection for this product, during a storm or when it is left unattended and unused for long periods of time, unplug it from the wall outlet. This will prevent damage to the product due to lightning and power-line surges. However, while it is thundering or lightning, do not touch the apparatus and any connected cable and/or equipment. This will prevent you from receiving the electric shock by an electric surge.

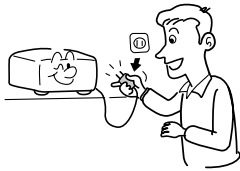

## 11. Object and Liquid Entry

Never push objects of any kind into this product through its openings as they may touch dangerous voltage points or short-out parts that could result in a fire or electric shock. Never spill liquid of any kind on the product.



## 12. Do not place the product vertically

Do not use the product in the upright position to project the pictures at the ceiling, or any other vertical positions. It may fall down and cause damage to the product.

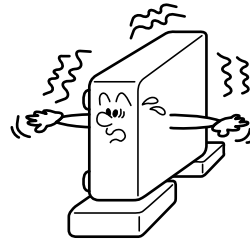

## 13. Stack Inhibited

Do not stack other equipment on this product or place this product on the other equipment. The top and bottom of this product radiates heat and may overheat or cause damage to the other equipment.

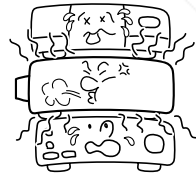

## 14. Attachments

Do not use attachments not recommended by the product manufacturer as they may cause hazards.

## 15. Accessories

Do not place this product on an unstable cart, stand, tripod, bracket, or table. The product may fall, causing serious injury to a child or adult, and serious damage to the product. A product and cart combination should be moved with care. Quick stops, excessive force, and uneven surfaces may cause the product and cart combination to overturn.



S3125A

## 16. Damage Requiring Service

Unplug this product from the wall outlet and refer servicing to qualified service personnel under the following conditions:

- a) When the power-supply cord or plug is damaged.
- b) If liquid has been spilled, or objects have fallen into the product.
- c) If the product has been exposed to rain or water.
- d) If the product does not operate normally by following the operating instructions. Adjust only those controls that are covered by the operating instructions as an improper adjustment of other controls may result in damage and will often require extensive work by a qualified technician to restore the product to its

- e) If the product has been dropped or damaged in any way.
- f) When the product exhibits a distinct change in performance - this indicates a need for service.

## 17. If glass components, including the lens and lamp, should break, contact your dealer for repair service.

This product incorporates glass components, including a lens and a lamp. If such parts should break, please handle with care to avoid injury and contact your dealer for repair service. The broken pieces of glass may cause injury. In the unlikely event of the lamp rupturing, thoroughly clean the area around the projector and discard any edible items placed in that area.

## 18. Servicing

Do not attempt to service this product yourself as opening or removing covers may expose you to dangerous voltage or other hazards. Refer all servicing to qualified service personnel.



FixYourDLP.com

Sponsored by DM

Discount-Merchant.com (800) 281-8860

THE TRUSTED SOURCE FOR PROJECTOR LAMPS AND ACCESSORIES

# **IMPORTANT SAFETY INSTRUCTIONS (Continued)**

## **19. Replacement Parts**

The user may perform replacement of the lamp but a service technician should make all other repairs. When replacement parts are required, be sure the service technician has used replacement parts specified by the manufacturer or have the same characteristics as the original part. Unauthorized substitutions may result in fire, electric shock, or other hazards.

## **20. Safety Check**

Upon completion of any service or repairs to this product, ask the service technician to perform safety checks to determine that the product is in proper operating condition.

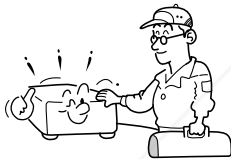

## **21. Do not leave thermal-paper documents or easily deformed items on top of the unit or near the air exhaust for long periods of time.**





The heat from the unit could erase the information on the thermal paper, or cause deformation or warping.

## **22. Do not use the product in a closed installation state.**

Do not place the product in a box or in any other closed installation state otherwise it may overheat. This could result in a risk of fire.

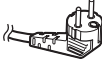
# POWER SUPPLY CORD SELECTION

If your line voltage is 220 to 240V, use one of the following types of cable.

Plug configuration	Plug type	Line voltage	Plug configuration	Plug type	Line voltage
	EURO	220 - 240V		Australian 240V 10A	220 - 240V
	UK	220 - 240V		Switzerland 240V 6A	220 - 240V
<p>Use a 5A fuse which is approved by ASTA or BSI to BSI362. Always replace the fuse cover after changing the fuse.</p>				North American 240V 15A	220 - 240V

Before Using

## IMPORTANT PRECAUTIONS

### Save Original Packing Materials

The original shipping carton and packing materials will come in handy if you ever have to ship your projector. For maximum protection, repack the set as it was originally packed at the factory.

### Moisture Condensation

Never operate this unit immediately after moving it from a cold location to a warm location. When the unit is exposed to such a change in temperature, moisture may condense on the crucial internal parts. To prevent the unit from possible damage, do not use the unit for at least 2 hours when there is an extreme or sudden change in temperature.

### Location and Installation

- Do not place in hot locations, such as near a heater or in direct sunlight. Doing so could cause malfunction, and shorten the life of the projector.
- Avoid locations with oil or cigarette smoke, which can affect the quality and useful life of the product optical parts and darken the screen.
- Do not use the product vertically in any upright position or slantwise in an angle of 20 degrees or more.
- Using this instrument near a TV or radio may cause interference to the images or sound. If this happens, move it away from the TV or radio.

In a high altitude location where air is thin, cooling efficiency is reduced so use it with the ambient temperature being lowered.

- The set of projector is hot after use. Handle with care.
- Do not use the projector while holding it in your hands or lap.
- Do not use the projector near a power source and the like, or in locations like a ship or vehicle that are subject to vibration or shock. Doing so may lead to a malfunction or shorten service life.

Fix Your Projector  
 Discontinued Models (800) 281-8860  
 THE ONLY SOURCE FOR PROJECTOR PARTS AND ACCESSORIES

# IMPORTANT PRECAUTIONS (Continued)

## **Avoid Volatile Liquid**

Do not use volatile liquids, such as an insect spray, near the unit. Do not leave rubber or plastic products touching the unit for a long time. They will leave marks on the finish. If cleaning with a chemically saturated cloth, be sure to follow the product's precautions.

# EXEMPTION CLAUSES

- Toshiba Corporation bears no responsibility in the case of damages arising from natural disaster such as earthquakes, lightning, etc., fire not liable to Toshiba Corporation, acts by third parties, other accidents, or use under abnormal conditions including erroneous or improper operation and other problems.
- Toshiba Corporation bears no responsibility for incidental damages (lost profit, work interruption, corruption or loss of the memory contents, etc.) arising from the use of or the inability to use this unit.
- Toshiba Corporation accepts no liability whatsoever for any damages arising from not having followed the descriptions in this Instruction Manual.
- Toshiba Corporation accepts no liability whatsoever for any damages arising from malfunctions arising from combination with equipment or software that is not related to Toshiba Corporation.

# OTHER CAUTIONS AND INFORMATION

## **Copyrights**

Showing or transmitting commercial imaging software or broadcast or cable-broad casting programs with the purpose of other than the personal and private viewing, including modifying images using the freeze functions, or displaying with the varying aspect ratio of the images, could violate the direct or indirect copyrights of the imaging software or broadcast program, etc., if done without first consulting with the copyright holder. For this reason, please take appropriate measures before performing one of the actions listed above, including obtaining a license from the copyright holder.

## **Disposal**

This product contains substances which are harmful to humans and the environment.

- The lamp contains mercury.

Please dispose of this product or used lamps in accordance with local regulations.

### **Following information is only for EU-member states:**

The use of the symbol indicates that this product may not be treated as household waste. By ensuring this product is disposed of correctly, you will help prevent potential negative consequences for the environment and human health, which could otherwise be caused by inappropriate waste handling of this product. For more detailed information and recycling of this product, please contact your local city office, your household waste disposal service or the shop where you purchased the product.



# OTHER CAUTIONS AND INFORMATION (Continued)

## Trademarks

- VGA, SVGA, XGA, SXGA, UXGA are registered trademarks of International Business Machines Corporation.
- Digital Light Processing (DLP), Digital Micromirror Device and DMD are registered trademarks of Texas Instruments.
- HDMI, the HDMI logo and High-Definition Multimedia Interface are trademarks of HDMI licensing LCC.
- HQV and HQV logo are registered trademarks of Silicon Optix.
- Dolby, Dolby Digital, Pro Logic and Double D symbol are registered trademarks of Dolby Laboratories.
- DivX and DivX logo are registered trademarks of DivX, Inc.
- Vikuiti and Vikuiti logo are registered trademarks of 3M.
- Kensington, MicroSaver, and ComboSaver are registered trade marks of Kensington Computer Products Group.
- All other trademarks and registered trademarks are the property of their respective owners.

## Notational Conventions Used in This Manual

- References to pages with related information are annotated as follows. For example, if making a reference to page 36. [p.36](#)
- The illustrations in this document are for reference purposes only and may not reflect your package exactly.

## Surround

- 5.1ch audio output is driven by 6 internal speakers. The sound surrounding effect is different from its ideal case provided by surrounding external speakers.
- This projector with 5.1ch Dolby Digital Consumer Decoder and Dolby Pro Logic II has been evaluated and approved by Dolby Laboratories.
- This projector is manufactured under license from Dolby Laboratories.

## REMOTE CONTROL BATTERIES

- Never throw batteries into a fire.
- Be sure to use AAA size batteries.
- Attention should be drawn to the environmental aspects of battery disposal.
- Do not mix different battery types or combine used batteries with new ones.
- If the remote control does not operate correctly, or if the operating range becomes reduced, replace both batteries with new ones.
- If the batteries are dead or if you will not be using the remote control for a long time, remove the batteries to prevent battery acid from leaking into the battery compartment.

Using the batteries improperly may cause them to explode or leak and lead to burns or injury. If battery-leaking fluid contacts skin, wash the fluid off immediately with clean water and consult a doctor. If the fluid is spilled on an instrument, avoid contact and wipe it off using a soft cloth or tissue paper. Dispose of the used cloth or tissue paper.



# NOTES ON DISCS

## On handling discs

- Do not touch the playback side of the disc.

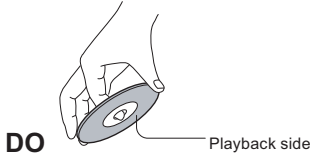

- Do not attach paper or tape to discs.



## On cleaning discs

- Fingerprints and dust on the disc cause picture and sound deterioration. Wipe the disc from the center outwards with a soft cloth. Always keep the disc clean.



- Do not use any type of solvent such as thinner, benzene, commercially available cleaners or antistatic spray for vinyl LPs. It may damage the disc.

## On storing discs

- Do not store discs in a place subject to direct sunlight or near heat sources.
- Do not store discs in moisture and dust places such as a bathroom or near a humidifier.
- Store discs vertically in a case. Stacking or placing objects on discs outside of their case may cause warping.

## Notes on copyright

The unauthorized recording, use, distribution, or revision of television programs, videotapes, DVDs, and other materials is prohibited under the Copyright Laws.

## Structure of disc contents

Normally, DVD video discs are divided into titles, and the titles are sub-divided into chapters. Video CDs and Audio CDs are divided into tracks.

DVD video disc

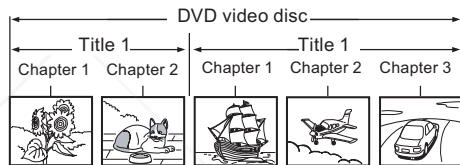

Video CD/Audio CD

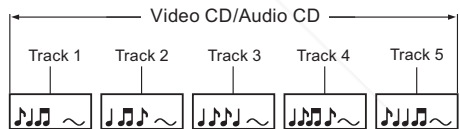

Each title, chapter or track is assigned a number, which is called "title number", "chapter number" or "track number" respectively. There may be discs that do not have these numbers.

## About this owner's manual

This owner's manual explains the basic instructions of this unit. Some DVD video discs are produced in a manner that allows specific or limited operation during playback. As such, the unit may not respond to all operating commands. This is not a defect in the unit. Refer to instruction notes of discs.

**Notes on region codes**

The region code of this unit is set according to the location you purchased the unit. If region codes, which stand for their playable area, are printed on your DVD video disc and you do not find  or region code matches to your unit, disc playback will not be allowed by the player. Some DVDs that have no region code label may still be subject to area restrictions and therefore not playable.

**On Video CDs**

This unit supports Video CDs equipped with the PBC (Version 2.0) function. (PBC is the abbreviation of Playback Control.) You can enjoy two playback variations depending on types of discs.

• **Video CD not equipped with PBC function (Version 1.1)**



Sound and movie can be played on this unit in the same way as an audio CD.

• **Video CD equipped with PBC function (Version 2.0)**

In addition to operation of a Video CD not equipped with the PBC function, you can enjoy playback of interactive software with search function by using the menu displayed on the screen (Menu Playback). Some of the functions described in this owner's manual may not work with some discs.

**Playable discs**

The following discs are available. DVD-Video, DVD+RW, DVD+R, DVD-RW, DVD-R, CD-DA, VCD, SVCD, ISO9600, CD-R, and CD-RW. Some of these discs may be incompatible. Be sure to always use only 12 cm discs.

	Disc Mark	Contents	Disc Size	Maximum playback time
DVD video discs		Audio + Video (moving pictures)	12 cm	Approx. 4 hours (single sided disc)
				Approx. 8 hours (double sided disc)
Video CDs		Audio + Video (moving pictures)	12 cm	Approx. 74 minutes
Audio CDs		Audio	12 cm	Approx. 74 minutes

The following discs are also available.

- DVD-R/RW discs of DVD video format
- CD-R/CD-RW discs of CD-DA, Video CD, or MP3 format

- You cannot play discs other than those listed above.
- You cannot play discs of DVD-RAM, Photo CD, etc., or non standardized discs even if they may be labeled as above.
- Some CD-R/RWs cannot be played back depending on the recording conditions.

Because of problems and errors that can occur during the creation of DVD software and/or the manufacture of DVD discs, Toshiba cannot guarantee that this player will play every feature of every DVD bearing the DVD logo.

As one of the creators of DVD technology, Toshiba DVD players are manufactured to the highest standards of quality and, as a result, such incompatibilities are very rare.

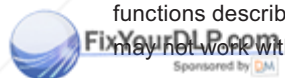

# CONTENTS

---

## Before Using

SAFETY PRECAUTIONS .....	2
IMPORTANT SAFETY INSTRUCTIONS .....	4
POWER SUPPLY CORD SELECTION.....	9
IMPORTANT PRECAUTIONS .....	9
EXEMPTION CLAUSES .....	10
OTHER CAUTIONS AND INFORMATION.....	10
REMOTE CONTROL BATTERIES.....	11
NOTES ON DISCS .....	12
CONTENTS .....	14

## Preparations

Checking the package contents.....	16
Names of each part on the main unit.....	17
Control panel and remote control parts for TDP-ET10.....	18
Control panel and remote control parts for TDP-ET20.....	19
Terminal panel.....	20
Preparing and using the remote control .....	21
Placement .....	22
Connection.....	24

## Operations

Turning the power on and off .....	26
Basic operations .....	28
TDP-ET20 DVD playback .....	31
About DVD VCD CD .....	31
Setup the DVD player. ....	31
PASSWORD (For Parental control).....	31
PARENTAL .....	32
DEFAULT (RESET) .....	32
DivX® VOD .....	32
PBC setting .....	33
OSD LANGUAGE .....	33
AUDIO LANGUAGE .....	33
SUBTITLE LANGUAGE .....	33
MENU LANGUAGE .....	34
Playing a disc. ....	34
1. Basic playback .....	34
2. Playing in fast reverse or fast forward directions .....	36
3. To pause playback (still playback).....	36

4. Locating a chapter or track.....	36
5. Repeat playback .....	37
6. Random playback .....	37
7. Changing angles .....	37
8. Title selection .....	37
9. Changing soundtrack language .....	38
10. Subtitles .....	38
11. Display status .....	38
12. Multimedia files on DVD/CD playback .....	39
Using menus .....	41
How to use the menus .....	41
Input MENU .....	42
Picture setting MENU .....	42
Audio setting MENU .....	45
Setup MENU .....	46
Status display MENU .....	47
<b>Maintenance</b>	
About lamp .....	49
Lamp replacement .....	49
Lens and main unit cleaning .....	52
<b>Others</b>	
Trouble indications .....	53
Before calling service personnel .....	54
Specification .....	56
List of general specifications .....	56
Separately sold product .....	56
List of supported signals (Y/Pb/Pr signals) .....	57
List of supported signals (Video, S-Video signals) .....	57
CONTROL terminal .....	58



**Discount-Merchant.com (800) 281-8860**  
**THE TRUSTED SOURCE FOR PROJECTOR LAMPS AND ACCESSORIES**

# Checking the package contents

Check that the following items are included in the box, along with the main unit. If any item is missing, please contact the store where you purchased the product.

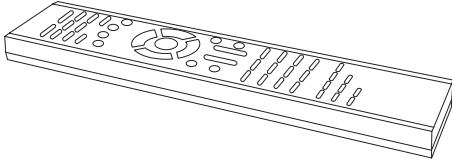

(1) Remote control<sup>\*1</sup>

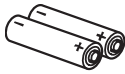

(2) R03 (size AAA) batteries for remote control

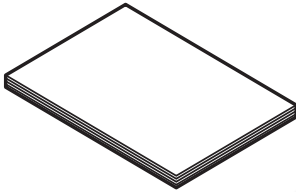

(3) Owner's manual (this book)



(4) Power cord<sup>\*2</sup>

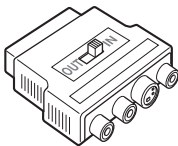

(5) Scart adapter<sup>\*3</sup>

\*1 Remote shape of TDP-ET10 is different from this figure. [p.18](#)

\*2 The shape of supplied power cord varies on the product destination.

\*3 Scart adapter is not supplied on some product destinations.

# Names of each part on the main unit

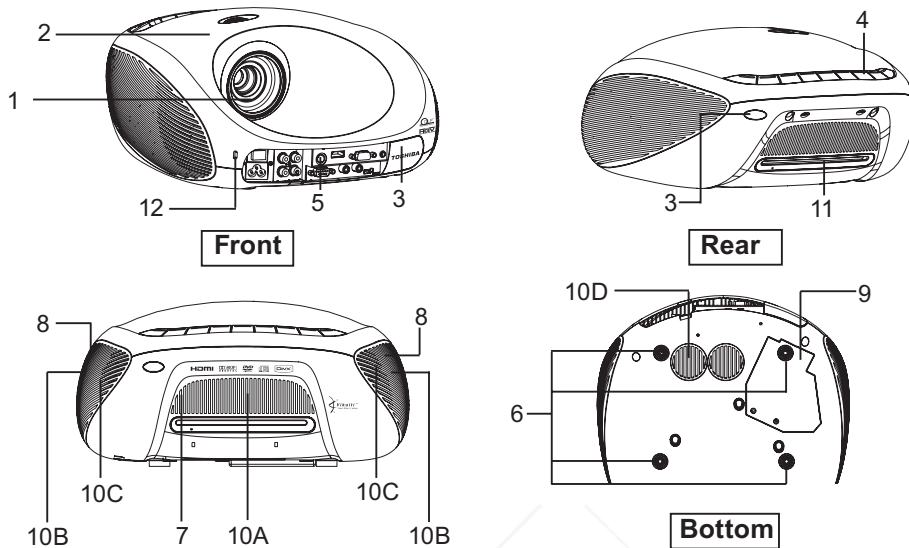

Preparations

For more information, see the pages in parentheses.

Name	Function
(1) Lens	Project expanded image.
(2) Focusing ring	Adjust screen focus.
(3) Infrared remote sensor	Sense commands from the remote control.
(4) Control panel	Adjust the main functions of the projector. <a href="#">p.18</a> - <a href="#">p.19</a>
(5) Terminal panel	Connect external devices. <a href="#">p.20</a>
(6) Foot adjuster	Adjust the vertical projection angle.
(7) Air intake	Draw in air from outside the projector.
(8) Air exhaust	Expel air that has grown hot inside the projector.
(9) Lamp cover	Open for lamp replacement. <a href="#">p.50</a>
(10) Built-in 5.1 speakers	Built-in speakers to discrete audio channels.
10A. Center speaker	Built-in speaker for center channel sound.
10B. Front speakers	Built-in speaker for front channels sound.
10C. Rear speakers	Built-in speaker for rear channels sound.
10D. Subwoofer speaker	Built-in speaker for subwoofer sound.
(11) Disc slot (for TDP-ET20)	Insert DVD or CD disc. <a href="#">p.31</a>
(12) Antitheft lock hole	TOSHIBA recommend to use Kensington's MicroSaver or ComboSaver for antitheft lock. For detail, please see the internet web site: <a href="http://www.kensington.com">www.kensington.com</a>



Discount-Merchant.com (800) 281-8860

THE TRUSTED SOURCE FOR PROJECTOR LAMPS AND ACCESSORIES

# Control panel and remote control parts for TDP-ET10

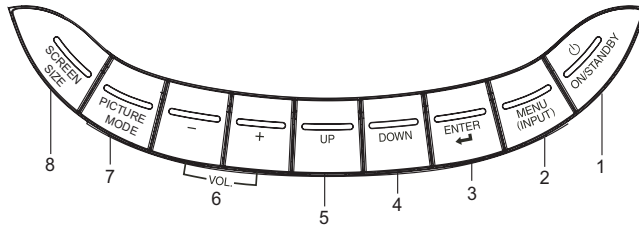

[TDP-ET10 control panel]

[TDP-ET10 Remote]

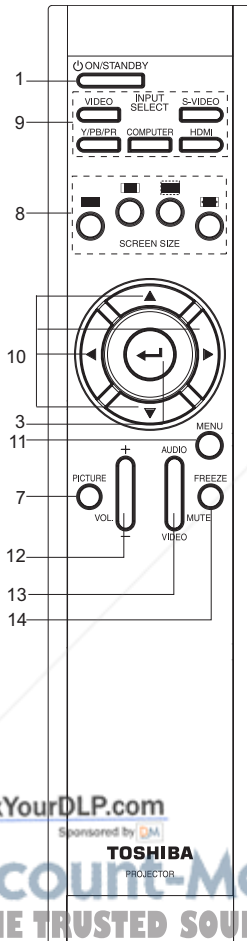

For more information, see the pages in parentheses.

- (1) ON/STANDBY: Switch projector between ON and STANDBY.
- (2) MENU (INPUT):  
Access the main programming menu or select input source. [p.41](#)
- (3) ENTER : Activate highlighted item in the on screen menu.
- (4) DOWN: Move down and highlight the item.
- (5) UP: Move up and highlight the item.
- (6) + -: Increase / decrease the volume.
- (7) PICTURE: Select picture mode. [p.42](#)
- (8) SCREEN SIZE: Select screen size. [p.43](#)  
Full , 4:3 , Zoom , Theater Wide .
- (9) INPUT SELECT: Select Video, S-Video, YP<sub>B</sub>PR, Computer, or HDMI.
- (10) : Select or adjust on screen programming menus.
- (11) MENU: Access the main programming menu. [p.41](#)
- (12) Vol +/-: Increase / decrease the volume
- (13) AUDIO MUTE: Cut off the sound temporarily.  
VIDEO MUTE: Black out the projected image.
- (14) FREEZE: Freeze the screen.

# Control panel and remote control parts for TDP-ET20

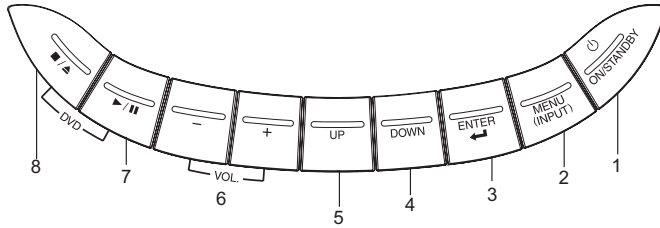

[TDP-ET20 control panel]

[TDP-ET20 Remote]

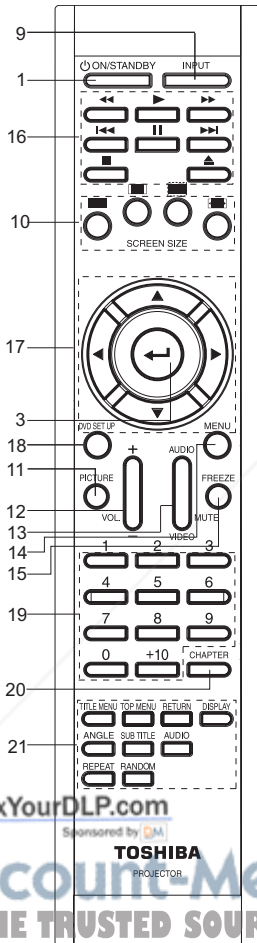

- (1) ON/STANDBY: Switch the projector between ON and STANDBY.
- (2) MENU (INPUT): Access the main programming menu or select input source. [p.41](#)
- (3) ENTER (↔): Activate highlighted items in the on screen menu.
- (4) DOWN: Move down and highlights the item.
- (5) UP: Move up and highlights the item.
- (6) + -: Increase / decrease the volume.
- (7) ▶ / ||: Play the disc or Pause the disc.
- (8) ■ / ▲: Stop the disc or Eject the disc.
- (9) INPUT: Select input source.
- (10) SCREEN SIZE: Select screen size. [p.43](#)  
Full ■, 4:3 ■, Zoom ■, Theater Wide ■.
- (11) PICTURE: Select picture mode. [p.42](#)
- (12) VOL + -: Increase/decrease the volume.
- (13) AUDIO MUTE: Cut off the sound temporarily.  
VIDEO MUTE: Black out the projected image.
- (14) MENU: Access the main programming menu. [p.41](#)
- (15) FREEZE: Freeze the screen.

### DVD Operation Keys

- (16) Basic operation keys
 

◀◀ Fast Reverse	▶ Play	▶▶ Fast Forward
◀◀ PREV	Pause	▶▶ NEXT
■ Stop	▲ Eject	
- (17) Navigation Keys
  - ▲ ◀ ◃ ▶ Select or adjust on screen programming menus.
  - ↻ Press key to confirm current operation.
- (18) DVD SETUP: Press to access the DVD setup menu. [p.31](#)
- (19) Number keys: Press number keys to play desired title.
- (20) CHAPTER: Press to display Title/Chapter access menu.  
You can access desired section by pressing number and ◀ ▶ ↻ keys.
- (21) Other operation keys
 

TITLE MENU	Press to display the DVD title menu.
TOP MENU	Press to display the DVD root menu. <a href="#">p.37</a>
RETURN	Press to return to the upper level menu.
DISPLAY	Press to display information such as Title/Chapter/Time etc. <a href="#">p.38</a>
ANGLE	Press to change angles in DVD. <a href="#">p.37</a>
SUB TITLE	Press to change subtitles setting. <a href="#">p.38</a>
AUDIO	Press to change soundtrack setting. <a href="#">p.38</a>
REPEAT	Press to change repeat playback mode. <a href="#">p.37</a>
RANDOM	Press to change random playback mode. <a href="#">p.37</a>

Preparations



# Terminal panel

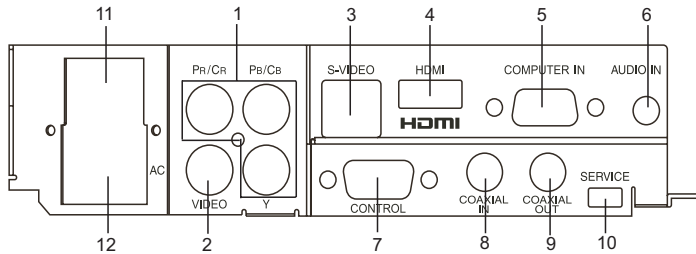

For more information, see the pages in parentheses.

Name	Function
(1) YP <sub>B</sub> PR/YC <sub>B</sub> CR (Component)	: Input component video signal from video equipment. <a href="#">p.24</a>
(2) VIDEO terminal	: Input video signal from video equipment. <a href="#">p.24</a>
(3) S-Video terminal	: Input S-Video signals from video equipment. <a href="#">p.24</a>
(4) HDMI terminal	: Input HDMI (Digital Audio/Video) signal from video equipment. <a href="#">p.25</a>
(5) COMPUTER IN terminal	: Input RGB signal from a computer. <a href="#">p.25</a>
(6) AUDIO IN terminal	: Inputs audio signals from equipment with audio output.
(7) CONTROL serial terminal	: When operating the projector via a computer, connect this to the controlling computer's serial port. <a href="#">p.58</a>
(8) COAXIAL (Digital Audio) In terminal	: Inputs digital audio source with coaxial output.
(9) COAXIAL (Digital Audio) Out terminal	: Outputs digital audio signal to external audio system with coaxial input.
(10) Service terminal	: For service purpose only.
(11) Main power switch	: Switch power on/off
(12) AC In socket	: Plug in AC Power

## Note

Although this owner's manual abbreviates component video signals as YP<sub>B</sub>PR, the product also supports signals from video equipment marked "YC<sub>B</sub>CR."

# Preparing and using the remote control

## ■ Loading dry-cell batteries into the remote control

(1) Remove the battery cover.

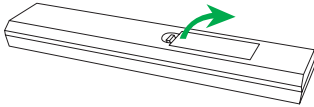

(2) Insert the dry-cell batteries.

Be sure to align the plus and minus ends of the batteries properly.

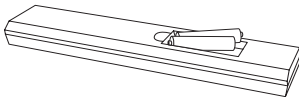

Two batteries (R03, size AAA) are used.

(3) Put back the battery cover.

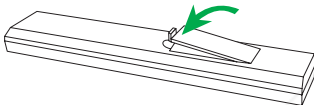

## ■ Point the remote control toward the projector's infrared remote sensor and press a button.

- Operating the projector from the front

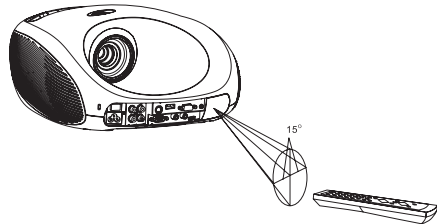

- Operating the projector from the rear

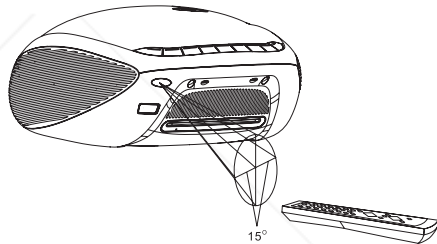

## ■ Dry-cell batteries

- Before using the batteries, be sure to observe the Safety Precautions described in previous pages.
- Remove batteries from remote control when not using for extended periods.
- If the remote control stops working, or if its range decreases, replace all the batteries with new ones.

## ■ The remote control

- The remote control may fail to operate if the infrared remote sensor is exposed to bright sunlight or fluorescent lighting.
- Do not drop the remote control or strike it on a hard surface.
- Do not leave it in a hot or humid location.
- Do not get it wet or place it on top of wet objects.
- Do not take it apart.
- In rare cases, ambient conditions could impede the operation of the remote control. If this happens, point the remote control at the main unit and repeat the operation.

# Placement

## Placement Styles

This device can be placed in some different placement styles. The factory setting is “floor-mounted front projection” although you can modify the setting according to your needs. Set the **Projection mode** in accordance with your needs through remote control or control panel, enter **SETUP** menu.

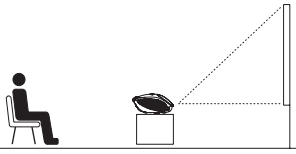
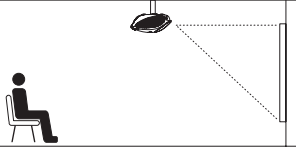
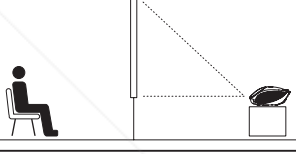
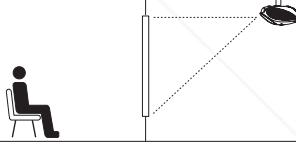
<b>Floor-mounted front projection (Standard)</b>	
<b>Ceiling-mounted front projection (Ceiling)</b> TDP-ET10 only	
<b>Floor-mounted rear projection (Rear)</b>	
<b>Ceiling-mounted rear projection (Rear Ceiling)</b> TDP-ET10 only	

### **WARNING**

- Always obey the instructions listed in the IMPORTANT SAFETY INSTRUCTIONS section of this manual when setting up the unit. Attempting to clean/replace the lamp at a high site by yourself may cause you to fall thus resulting in injury.
  - If you wish to mount the projector on the ceiling, be sure to ask your dealer to do so. Mounting the projector on a ceiling requires special ceiling brackets (sold separately) and specialized installation knowledge. Improper mounting could cause the projector to fall resulting in a serious injury.
- If the projector is ceiling-mounted, install the breaker for turning off the power in case of anomaly. Let everyone involved with the use of the projector know that fact.

### **Note**

In order to avoid image distortion, place the projector at flat platform, the slope should not over 20 degree. Surface of projection screen or wall should be flat and neat.

## Projection Distance and Size

Use the figures, tables, and formulas below to determine the projection size and projection distance. (Projection sizes are approximate values for full-size picture with no keystone adjustment.)

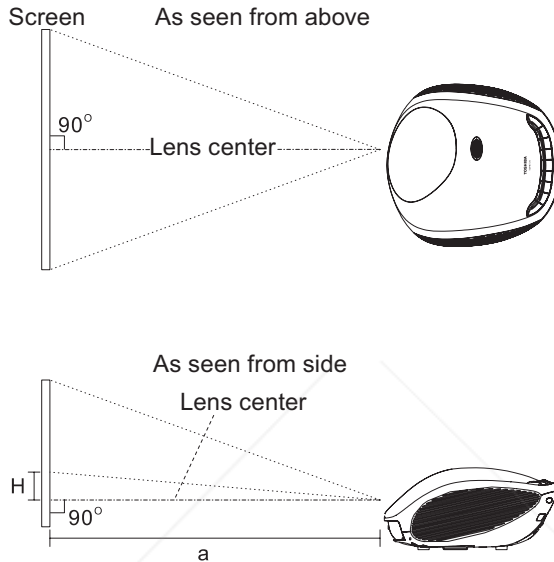

$$a \text{ (cm)} = \text{projection size (inches)} \times 1.433 - 13.32$$

$$H \text{ (cm)} = \text{projection size (inches)} \times 0.1868$$

“a” is the distance (cm) between front edge of the projector and the screen, and corresponds to a range of 40 cm to 177 cm. “H” is the height from the image bottom to the center of the lens.

projection size inches (=cm)	projection distance a (cm) [inches]	height (H) (cm) [inches]
	Edge of the projector to image	
40 (=101.6 cm)	44.0 [17.3]	7.5 [2.9]
50 (=127.0 cm)	58.3 [23.0]	9.3 [3.7]
60 (=152.4 cm)	72.7 [28.6]	11.2 [4.4]
80 (=203.2 cm)	101.3 [39.9]	14.9 [5.9]
100 (=254.0 cm)	130.0 [51.2]	18.7 [7.4]
120 (=304.8 cm)	158.6 [62.5]	22.4 [8.8]

# Connection

## Before connection

- Some types of computers cannot be used or connected to this projector.
- Turn off the power of both devices before connecting.
- The figure below is a sample connection. This does not mean that all of these devices can or must be connected simultaneously.

## Overview of cable types:

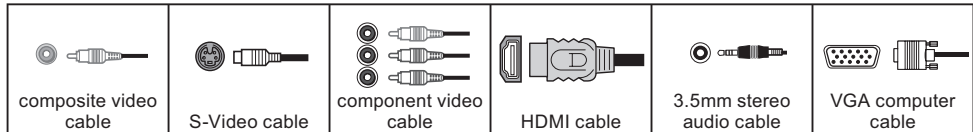

## ■ Main Input

### Connecting with Video/S-Video/Component

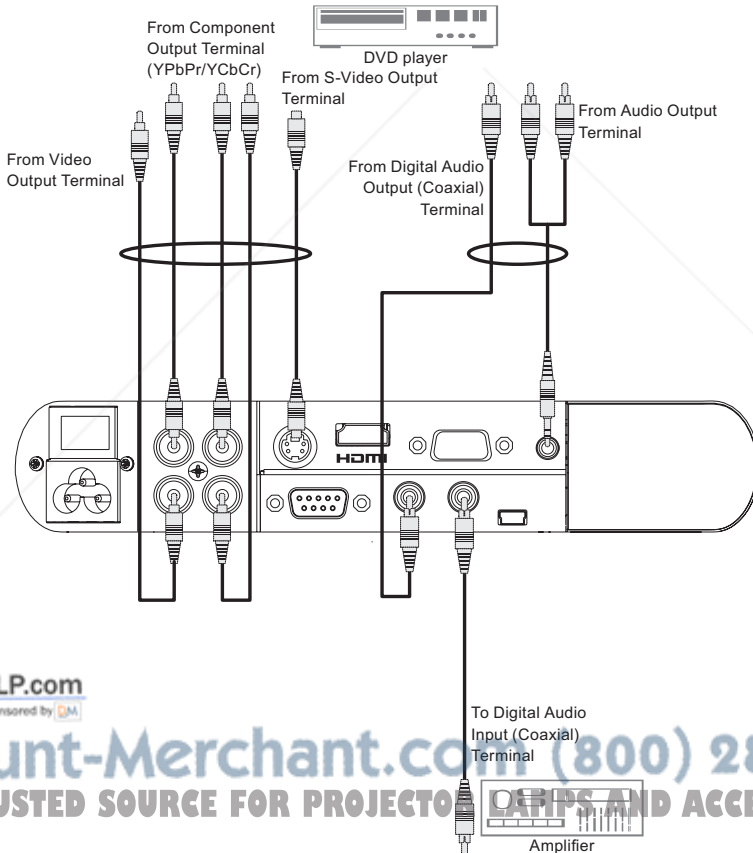

## Connecting with HDMI

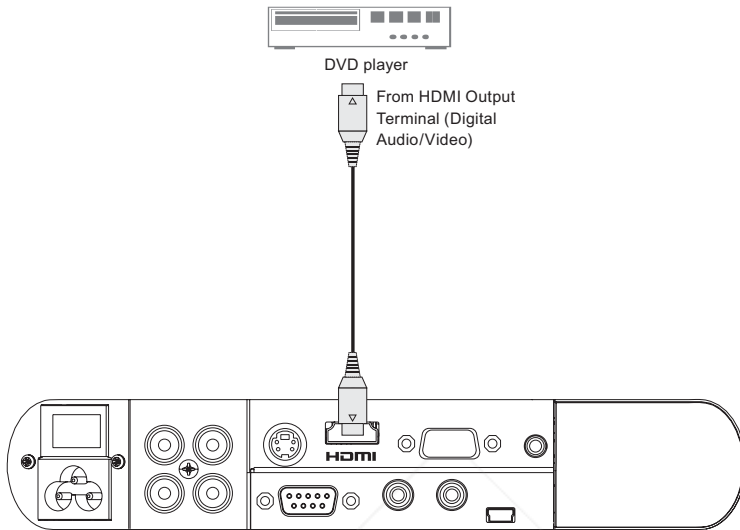

## Connecting with Computer

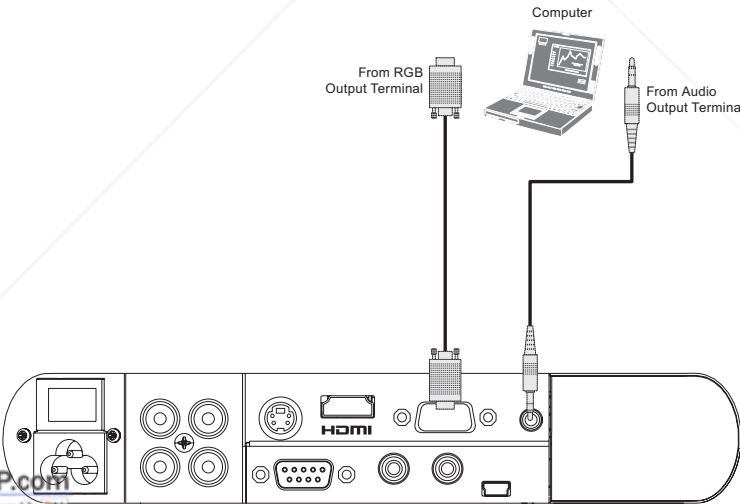

### ■ Notes

- To select audio input, use On Screen menu, see [p.28](#).
- Signals which resolution exceeds the native resolution (854 x 480 pixels) will be compressed. For this reason, some information may be lost, or image quality may be affected.
- Because HDMI™ is an evolving technology, it is possible that some devices may not operate properly with the projector.

# Turning the power on and off

## ■ Connecting the power cord

- 1 Insert the power cord connector into the AC IN socket of the projector.
- 2 Insert the power cord plug into a wall or other power outlet.

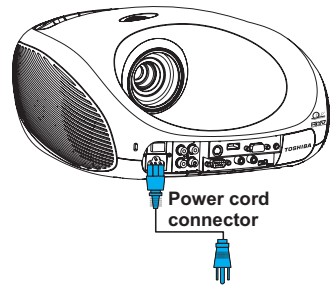

## ■ Turning the power on

- 1 Turn on the main power switch.  
The blue LED at the ON/STANDBY key will start to flash, indicating standby mode.

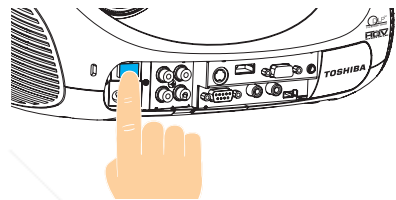

- 2 Activate the projector.

The projector can be activated by pressing the ON/STANDBY key on control panel for 3~5 seconds and releasing while the red LED is still lit. The projector is only activated by the ON/STANDBY key while the red LED is lit to prevent unwanted starting of the projector. When started all the blue LED on the control panel will light up and the Start-up screen will display.



The projector can be activated by remote control, too. In this case, it is no need to press the ON/STANDBY key for 3~5 seconds.

## ⚠ WARNING

- Do not look into the lens while the lamp is on. The strong light from the lamp may cause damage to your eyes or sight.
- Do not block the air intake or exhaust. Doing so could cause a fire due to internal overheating.
- Do not place your hands, face, or any other objects near the air exhaust. Doing so could cause injury or could deform or break the object.
- Turn off AC switch before plugging out power cable.

## ■ Using standby mode to save power and turning the power off

### ① Put the Projector into standby mode to save power.

Pressing the ON/STANDBY button once, a power off indication message will appear. Press the ON/STANDBY button to put the projector into standby mode. The power off message has to be displayed for the second press of the power button to be valid.

When cooling lamp



**A** Blue: on

After cooling complete



**B** Blue: blink

**A** The cooling fan will operate for about 60 seconds. In this state the power cannot be turned back on.

**B** In Standby mode. The ON/STANDBY indicator (Blue LED) is flashing.

### ② Press power switch to turn the power off.

Press the main power switch on the terminal panel to turn off the projector.

#### ■ Note

- The projector consumes about 4W of power in standby mode. We recommend that you unplug the power cord or turn off the main power switch if you will not be using the projector for an extended period.

#### ■ PRECAUTION

- If the power cord is unplugged before cooling is complete, give the lamp time (about 5 minutes) to cool before plugging it back in. If the lamp overheats, it may fail to light.



# Basic operations

## 1 Turn on the power.

Turn on the power by following the instruction in “Turning the power on” in [p.26](#).

## 2 Activate the connected device.

Turn on and start the connected device.

## 3 Select MENU language.

This projector can display the on screen language in English, French, German, Spanish, Italian, Portuguese, Japanese, Traditional Chinese, Simplified Chinese and Korean.

- (1) Press [MENU] key to display MENU.
- (2) Select SETUP icon using [UP] [DOWN] or ▲ ▼ key and press ⊖.
- (3) Select 'Language' and press ⊖.
- (4) Press [UP] [DOWN] or ▲ ▼ key to select desired language.

## 4 Select the INPUT source.

Input source can be changed using menu system.

- (1) Press [MENU] key to display MENU.
- (2) Select INPUT icon using [UP] [DOWN] or ▲ ▼ key and press ⊖.
- (3) Select 'Video input' to select video input and press ⊖.
- (4) Press [UP] [DOWN] or ▲ ▼ key to select desired input source.

Audio input source also can be changed.

- (5) Press [MENU] key to return the top of INPUT page.
- (6) Select 'Audio input' to select audio input and press ⊖.
- (7) Press [UP] [DOWN] or ▲ ▼ key to select desired audio input source.

Selected Audio input source is memorized for each video input.

Audio input will be changed automatically when video input source is changed.

Select input source by pressing [INPUT] key on the remote control as well.



TDP-ET10

or

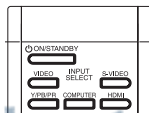

TDP-ET20

or

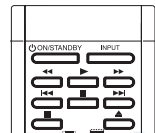

## 5 Projector placement angle adjustments

- (1) There are 4 adjustable feet on bottom of the projector.  
Each foot height can be adjusted by screwing and the placement angle and the height of the projected image can be changed.
- (2) To adjust the projection size, it is needed to change placement closer/farther to the projection screen.

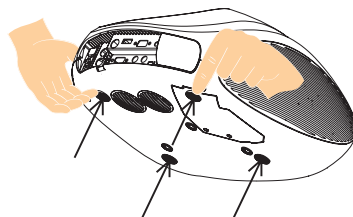

## 6 Adjusting the focus

Use focusing ring to adjust the focus.

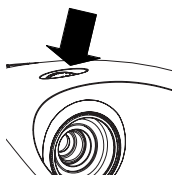

## 7 Select a screen size (aspect ratio)

The aspect ratio is the ratio of image width to image height. HDTV and most DVD movies are 16:9, which is the default for this projector. Most TV programs are 4:3. The image ratio can be changed using the 'SCREEN SIZE' button on the remote control. (Screen size can also be selected in 'PICTURE' page in MENU system.) [p.43](#)  
Select an aspect ratio to suit the format of the video signal. The following four aspect ratios are available.

- (1) Full  
Scales an image so that it is displayed in the full of the screen in 16:9 aspect ratio. This mode is best for squeeze-signal video images.
- (2) 4:3  
Scales an image so that it is displayed in the center of the screen in 4:3 aspect ratio. This mode is best for 4:3-signal video images.
- (3) Zoom  
Enlarges an image with letterbox format to display it in full screen format in 16:9 aspect ratio. The upper and lower portions of the image are cropped. Use this setting for wide-screen video in letterbox format.
- (4) Theater Wide®  
A 4:3 aspect ratio image is enlarged NON-linearly in horizontal direction to accommodate 16:9 full-screen display. This stretches only the right and left sides of the image; the central part is unchanged. This mode is best for 4:3-signal video images displayed on a wide screen.

# Basic operations (Continued)

---

## 8 Adjusting the volume

The speaker volume can be adjusted by pressing [-] [+] key on control panel or remote control.

## 9 Turning off the power



Turn off the power by following the instruction in “Turning the power off” in [p.27](#).



### ■ Note

- Note that a lamp characteristics may rarely cause the brightness to fluctuate slightly.
- A lamp is consumable item. If used for extended periods, images will appear dark, and the lamp could burn out. This is characteristic of a lamp, and is not malfunction. (The lifetime of the lamp depends on conditions of use.)
- The DMD™ is made using extremely advanced technology, but there may be black spots (pixels that do not light) or bright spots (pixels that are constantly lit) on the panel. Please note that these are not malfunctions.
- Although this projector supports a wide range of RGB signals, any resolutions not supported by this projector (WVGA) will be expanded or shrunk, which will affect image quality slightly. To view high-quality images, it is recommended that the computer's external output should be set to WVGA (854 × 480) resolution.
- With some models of computer having LCD displays or the like, displaying images simultaneously on the projector and the monitor's display may prevent the images from displaying properly. If this happens, turn off the computer's LCD display. For information on how to turn off the LCD display, see the owner's manual of your computer.
- If a signal not supported by the projector is input, the “Unsupported signal” will appear.
- If no signal is being input from the connected device, the “No signal” will appear.

# TDP-ET20 DVD playback









## About

The    icons on the heading bar show the playable discs for the function described under that heading.

-  You can use this function with DVD video discs.
-  You can use this function with Video CDs.
-  You can use this function with Audio CDs and CD-R/RW discs.

## Setup the DVD player.





You can setup the DVD player setting.

- (1) Press [DVD SETUP] key on the remote control when DVD input is selected. DVD setup menu will appear.
- (2) In DVD setup menu, there are 2 pages. One is SYSTEM SETUP page and the other is LANGUAGE SETUP page. Press   key to select page and press   key to select each setup item.
- (3) To exit from DVD setup menu, press     key to select EXIT SETUP or [DVD SETUP] key again.

## PASSWORD (For Parental control)







### Unlock the password lock

To change parental level or password, it is required to enter password (4 digit security code) for unlocking.

- (1) Select the PASSWORD in SYSTEM SETUP page and press  or  key.
- (2) Press number key to input current password and press  key (If the password has not been set yet after you purchase this projector, it is '0000').
- (3) If correct password is entered,  will appear. If  is still displayed, it means entered password is incorrect. Please enter the correct password again.

### Enter a new password

New password can be set to replace the default password.

- (1) Select PASSWORD in SYSTEM SETUP page and press  or  key.
- (2) Please make sure  is displayed. If  is displayed, it is required to unlock the password lock.
- (3) Press number button to input new password and press  key. Be sure to remember this number.
- (4) Select EXIT SETUP and press  key to save a new password.

If you forget the password, you can erase your current password by entering password as '1048'.



# TDP-ET20 DVD Playback (Continued)

## PARENTAL

DVD discs equipped with the password function are rated according to their content. The contents allowed by a parental lock level and the way a DVD disc can be controlled may vary from disc to disc.

### ■ Notes

DVD video discs may or may not respond to parental lock settings. This is not a defect in the DVD player. Make sure this function works with your DVD video discs.

Before changing the rating, it is required to enter password for unlocking. Please see the PASSWORD heading. [p.31](#)

- (1) Select RATING in SYSTEM SETUP page and press ⏪ or ⏩ key.
- (2) Press ⏴ ⏵ key to select the rating from 1 to 8. Rating 1 is restrictive while rating 8 can virtually playback all DVD software.

The parental lock level is equivalent in USA to following.

- Level 1: Kid safe
- Level 2: G
- Level 3: PG
- Level 4: PG-13
- Level 5: PG-R
- Level 6: R
- Level 7: NC-17
- Level 8: Adult

## DEFAULT (RESET)

DVD setting except PASSWORD can be set to factory default using this menu.

- (1) Select DEFAULT in SYSTEM SETUP page and press ⏪ or ⏩ key.
- (2) Select RESTORE to set DVD setting to factory default.

### ■ Notes

This function only effects DVD setting. Other setting such as projector setting will not set to default if restored.

## DivX® VOD

Some DivX® Video-On-Demand files require registration code. Please get the code of your DVD video player as follow:

- (1) Select DIVX® VOD in SYSTEM SETUP page.
- (2) Your registration code will be shown.

### ■ Notes

This registration code is for DivX® Video-On-Demand only, do not apply this code for other applications or website.

## PBC setting (VCD)

This DVD supports Video CDs equipped with the PBC (Version 2.0) function. (PBC is the abbreviation of Playback Control.) You can enjoy two playback variations depending on types of discs.

- Video CD not equipped with PBC function (Version 1.1)

Sound and movie can be played on this DVD in the same way as an audio CD.

- Video CD equipped with PBC function (Version 2.0)

In addition to operation of a Video CD not equipped with the PBC function, you can enjoy playback of interactive software with search function by using the menu displayed on the screen (Menu Playback).

Some of the functions described in this owner's manual may not work with some discs.

- (1) Select PBC in SYSTEM SETUP page and press ◀ or ▶ key.
- (2) Press ▲ ▼ key to select ON/OFF and press ◀ key.

## OSD LANGUAGE

On Screen Display (OSD) language can be selected in this menu. This setting is effective for DVD setup menu only.

- (1) Select OSD LANG in LANGUAGE SETUP page and press ◀ or ▶ key.
- (2) Press ▲ ▼ key to select OSD language and press ◀ key.

## AUDIO LANGUAGE (DVD)

Audio language can be selected in this menu. If you want to output other language, please use [AUDIO] key on the remote while playing the DVD.

- (1) Select AUDIO LANG in LANGUAGE SETUP page and press ◀ or ▶ key.
- (2) Press ▲ ▼ key to select Audio language and press ◀ key.

### ■ Notes

Some DVD video discs may be played in a different language other than you selected. A prior language may be programmed on the disc.

## SUBTITLE LANGUAGE (DVD)

Subtitle language can be selected in this menu. If you want to display other language, please use [SUBTITLE] key on the remote during play the DVD.

- (1) Select SUBTITLE LANG in LANGUAGE SETUP page and press ◀ or ▶ key.
- (2) Press ▲ ▼ key to select Subtitle language and press ◀ key.

### ■ Notes





Some DVD video discs may be set to display subtitles in a different language other than you selected. A prior subtitle language may be programmed on the disc.

Some DVD video discs allow you to change subtitle selections only via the disc menu. If this is the case, press the [TOP MENU] key on the remote and choose the appropriate subtitle language from the selection on the disc menu.

# TDP-ET20 DVD Playback (Continued)

## MENU LANGUAGE

DVD menu language can be selected in this menu.









- (1) Select MENU LANG in LANGUAGE SETUP page and press  or  key.
- (2) Press   key to select DVD menu language and press  key.

### ■ Notes

Some DVD video discs may not include your pre-selected language. In this case, the DVD video player automatically displays disc menus consistent with the disc's initial language setting.

## Playing a disc.

### 1. Basic playback

- (1) Turn on the power and select DVD input.
- (2) The DVD startup screen will appear on the screen.
- (3) Load the disc in the disc slot with the label side facing up. (If the disc has a label.)  
Hold the disc without touching either of its surfaces, align it with the guides, and place it in position.
- (4) "READ" appears on the screen, then playback starts.
  - A menu screen will appear on the screen, if the disc has a title menu.
  - Press     on the remote control to select title, then press  key. Title is selected and play commences.
- (5) Press VOL [+] [-] to adjust the volume.
  - When using an amplifier, adjust the volume with the amplifier.
- (6) Press  /  or  to end playback.

### ■ Notes

Insert a disc horizontally into the DVD disc slot, do not jam or force it strongly, otherwise the DVD may malfunction or the disc might be damaged.

### CAUTION

Never insert your finger into the disc hole when load the disc to the disc slot. Keep your fingers well clear of the disc slot when disc is loading or unloading. Neglecting to do so may cause personal injury.

**■ Notes**

Strong static electricity may affect the DVD player's operation and cause it not to work properly. If this happens, please try followings.

- (1) Press **■/▲** key for about 5 seconds. DVD player will eject the disc.
- (2) If DVD player still don't work, turn OFF the POWER, disconnect and then reconnect the AC power cord, and turn ON the projector again.

**To start playback in the stop mode:**

Press **▶/||** or **▶**

**To pause playback (still mode):**

Press **▶/||** or **⏸** during playback.

To resume normal playback, press **▶/||** or **▶**.

- The sound is muted during still mode.
- If **⏸** is pressed during pause, DVD plays frame by frame **(DVD)** **(VCD)**.

**To stop playback:**

Press **■/▲** or **⏻**

**To remove the disc:**

- (1) Press **■/▲** during stop or **⏻**.
- (2) Remove the disc after the disc comes out.

**■ Notes**

- If a non-compatible disc is loaded, "WRONG REGION" will appear according to the type of loaded disc. In this case, check your disc again.
- Some discs may take a minute or so to start playback.
- If you insert a single-sided disc the wrong way, "READ" will appear on the display for about 20-40 seconds. Then "NO DISC" will display and the disc will be ejected automatically.
- Some playback operations of DVDs may be intentionally fixed by software producers. Since this projector plays DVDs according to the disc contents the software producers designed, some playback features may not be available. Also refer to the instructions supplied with the DVDs.
- Do not move the projector during playback. Doing so may damage the disc. If you want to move the projector to other place or room, be sure to eject the disc and turn off the power beforehand.
- If the disc is not loaded even if the disc is inserted into the DVD disc slot, remove the disc once and try to load the disc again.
- Do not put any objects other than discs in the disc slot. Doing so may cause the projector to malfunction.
- When you press a button, there may be a slight delay before the function activates.



Fix to malfunction



**Discount-Merchant.com (800) 281-8860**  
**THE TRUSTED SOURCE FOR PROJECTOR LAMPS AND ACCESSORIES**



# TDP-ET20 DVD Playback (Continued)



## 2. Playing in fast reverse or fast forward directions



Press  or  during playback.

 (REW) : Fast reverse playback (2X-20X)

 (FF) : Fast forward playback (2X-20X)

Each time you press  or , the playback speed changes.



To resume normal playback, press  /  or .

### ■ Notes

- The projector mutes sound and subtitles during reverse and forward scan of DVD video discs (except playing x2 forward). However, the projector plays sound during fast forward(x2) or fast reverse(x2) play of audio CDs.
- The playback speed may differ depending on the disc.

## 3. To pause playback (still playback)



Press  /  or  during playback.

To resume normal playback, press  /  or .

### ■ Notes

The sound is muted during still playback.

## 4. Locating a chapter or track

Press  or  repeatedly during playback to select the chapter or track you want. Playback starts from beginning of the selected chapter or track.

### ■ Notes



The “” symbol may appear at the upper left of the screen. This means either the feature you tried is not available on the disc, or the DVD cannot access the feature at this time. This does not indicate a problem with the disc or this unit.

## 5. Repeat playback (DVD) (VCD) (CD)

Repeat playback allows you to repeat Chapter/Title/All (DVD) or Track/All (CD/VCD). Press [REPEAT] on the remote control during playback or stop mode.

Repeat mode will change repeatedly as following.

DVD:	Chapter ▶ Title ▶ All ▶ Off
CD/VCD:	Track ▶ All ▶ Off
DivX®/MP3:	One ▶ Folder ▶ All ▶ Off

- If you press  /  or , the Repeat function ends and playback stops.
- Some discs may not permit the repeat operation.
- Repeat does not work with an interactive DVD

## 6. Random playback (VCD) (CD)

Select tracks or files at random and playback.

Press [RANDOM] on the remote during playback.

Random mode will change ON or OFF.

## 7. Changing angles (DVD)

When playing back a disc recorded with multi-angle facility, you can change the angle that you are viewing the scene from.







- (1) Press [ANGLE] on the remote control during playback.  
The current angle will appear.
- (2) Press [ANGLE] repeatedly until the desired angle is selected.

### ■ Notes

Depending on the DVD, you may not be able to change the angles even if multi-angles are recorded on the DVD.

## 8. Title selection (DVD)

Two or more titles are recorded on some discs. If the title menu is recorded on the disc, you can select the desired title.

- (1) Press [TOP MENU] on the remote control during playback.  
Title menu appears on the screen.
- (2) Press     to select the desired title.
- (3) Press  or .

The playback of the selected title will start.

### ■ Notes

Depending on the DVD, you may not be able to select the title.

- Depending on the DVD, a "title menu" may simply be called a "menu" or "title" in the instructions supplied with the disc.

# TDP-ET20 DVD Playback (Continued)

- Depending on the DVD, the title menu may be displayed automatically when the disc is loaded.
- Depending on the DVD, a chapter menu may be displayed after you select a title.

## 9. Changing soundtrack language (DVD) (VCD)

You can select the language when you play a multilingual disc.

- (1) Press [AUDIO] on the remote control during playback.  
The current soundtrack language will appear.
- (2) Press [AUDIO] on the remote control repeated until the desired language is selected.
  - The selected soundtrack language will appear.

### ■ Notes

- If the desired language is not heard after pressing the button several times, the language is not recorded on the disc.
- Changing soundtrack language is cancelled when you eject the disc. The initial default language or available language will be heard if the disc is played back again.
- If you select DTS in playing DTS-encoded disc, no sound will be heard from the projector's speakers.
- Depending on the DVD disc, you may not be able to select the language by [AUDIO] key. It may be selected in the Title menu.

## 10. Subtitles (DVD)

When playing back a disc recorded with subtitles, you can select the subtitle language or turn the subtitle off.

- (1) Press [SUBTITLE] repeatedly during playback until you desired language appears.
- (2) To turn off the subtitle, press [SUBTITLE] until "OFF" appears.
  - The "OFF" on screen display will disappear after a few seconds.

### ■ Notes

- Depending on the DVD, you may not be able to change subtitles, or to turn subtitles on or off.
- While playing a DVD, the subtitle may change when you loaded or eject the disc.
- In some cases, a selected subtitle language may not be changed immediately.

## 11. Display status (DVD) (VCD) (CD)

With press of [DISPLAY], the status of the disc will appear on the screen as follows:

- (1) When DVD video is playing.

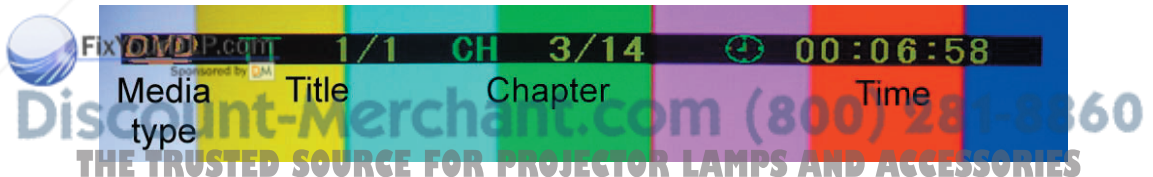

- Press [DISPLAY] again



- Press [DISPLAY] again to erase this OSD.
- (2) When CD/VCD is playing.

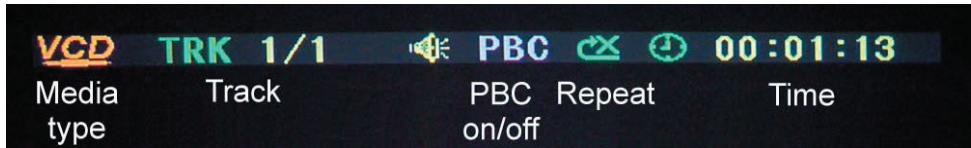

- Press [DISPLAY] again to erase this OSD.

## 12. Multimedia files on DVD/CD playback CD DVD

- (1) Load a disc on which Multimedia files have been recorded in the disc slot.
- (2) A file menu screen will appear on the screen.



Press ◀ ▶ to change folder window, file window, or file type buttons.

To change file types to play, press until file type display button is highlighted. And select following one file type icon desired and press ⊖.

MP3:  DivX®: 

- (3) In file window, press ▲ ▼ or Number buttons (0-9) to select the desired folder/file. The selected file starts playing back.
- (4) Press ⊖ to end playback.

### ■ Notes

- File name can't be displayed correctly in some languages such as Japanese, Chinese, and Korea etc.
- Supported DivX® file: ver. 3.11/4.0/5.x
- A file name must incorporate "mp3", "divx", or "avi" extension.

# TDP-ET20 DVD Playback (Continued)

---

- CD file system: ISO9660 Level1, 2, or Joliet.
- This internal DVD video player requires discs/recordings meet certain technical standards in order to achieve optimal playback quality. Pre-recorded DVDs are automatically set to these standards. There are many different types of recordable disc formats (including CD-R containing MP3/DivX<sup>®</sup> files). Because this area of technology is still evolving, Toshiba cannot guarantee that all recordable discs will produce optimal playback quality. The technical criteria set forth in this owner's manual are meant only as a guide.
- You must obtain any required permission from copyright owners to download to download or use copyrighted content. Toshiba cannot and does not grant such permission.



**Discount-Merchant.com (800) 281-8860**  
**THE TRUSTED SOURCE FOR PROJECTOR LAMPS AND ACCESSORIES**



# Using menus (Continued)

---

## ■ Input MENU

Video input source and audio input source can be selected separately in this projector.

### Video input

Video input source can be selected in this menu from DVD, Component, HDMI, Video, S-video and Computer.

Press . Select with / [UP] [DOWN] key.

### Audio input

Audio input source can be selected in this menu from DVD, HDMI, Digital (Coax) and Analog. Audio input source links to the video input source and it is memorized.

For example, after analog is selected for audio input when video input is S-video, analog will be selected automatically for audio input whenever S-video is selected for video input.

Press . Select with / [UP] [DOWN] key.

## ■ Picture setting MENU

### Picture mode

Select a picture mode. The following four modes are available for each input.

- Standard
- Dynamic
- Theater 1
- Theater 2

Press . Select with / [UP] [DOWN] key.

### Brightness

Adjust the brightness of the image.

Press . Adjust with / [ - ] (Darker) or / [ + ] (Brighter) key.

### Contrast

Adjust the image contrast.

Press . Adjust with / [ - ] (Lower) or / [ + ] (Higher) key

### Color

Adjust the color of the image.

Press . Adjust with / [ - ] (Lighter) or / [ + ] (Deeper) key.

### Tint

Adjust the tint of the image color.

Press . Adjust with / [ - ] (Reddish) or / [ + ] (Greenish) key.

This can be adjusted only when video input source is Video/S-video and input signal is NTSC or NTSC4.43.

### Sharpness

Adjust the sharpness of the image.

Press  $\ominus$ . Adjust with  $\leftarrow$  / [ - ] (Softer) or  $\rightarrow$  / [ + ] (Sharper) key.

### Detail enhancement

Set the function to enhance detail of the image.

Press  $\ominus$ . Adjust with  $\leftarrow$  / [ - ] (Lower) or  $\rightarrow$  / [ + ] (Higher) key.

### H-position

Adjust horizontal position of the image.

Press  $\ominus$ . Adjust with  $\leftarrow$  / [ - ] (Move left) or  $\rightarrow$  / [ + ] (Move right) key.

This can be adjusted when input source is Computer.

### V-position

Adjust vertical position of the image.

Press  $\ominus$ . Adjust with  $\downarrow$  / [ - ] (Move down) or  $\uparrow$  / [ + ] (Move up) key.

This can be adjusted when input source is Computer.

### Noise Reduction

Adjust the function to reduce screen noise.

Press  $\ominus$ . Select from Off/Low/Mid/High with  $\triangleup$   $\triangledown$  / [UP] [DOWN] key.

### Screen size

Set the screen size (aspect ratio) of the projection image.

- Press  $\ominus$ . Select from Full/4:3/Zoom/Theater wide with  $\triangleup$   $\triangledown$  / [UP] [DOWN] key.
- When input signal format is 1080i or 720p, actual screen size is fixed to Full without regard to the screen size setting.

### Advanced

Detailed adjustment is available in Advanced MENU.

Press  $\ominus$  to go to advanced MENU.

### Reset

Reset Picture setting MENU adjustments and settings to factory default.

Press  $\ominus$ . Confirmation window will appear and select [Yes] with  $\leftarrow$  / [ - ] or  $\rightarrow$  / [ + ] key and press  $\ominus$  to reset.



# Using menus (Continued)

---

## Advanced MENU

### Overscan

Adjust overscan ratio of the image.

Press  $\ominus$ . Adjust with  $\leftarrow$  / [ - ] (Lower) or  $\rightarrow$  / [ + ] (Higher) key.

No overscan when set to 100%

### NTSC mode

Set the black level for Video/S-video input.

Press  $\ominus$ . Select US(7.5IRE)/Japan(0IRE) with  $\blacktriangle$   $\blacktriangledown$  / [UP] [DOWN] key.

This can be adjusted only when video input source is Video/S-video and input signal is NTSC or NTSC4.43.

### HDMI mode

Set the black/white level for HDMI input.

Press  $\ominus$ . Select HDMI/DVI with  $\blacktriangle$   $\blacktriangledown$  / [UP] [DOWN] key.

This can be adjusted when input source is HDMI.

### Frequency

Adjust the sampling frequency to eliminate periodic patterns and flickering when many vertical lines appear on the screen.

Press  $\ominus$ . Adjust with  $\leftarrow$  / [ - ] or  $\rightarrow$  / [ + ] key.

This can be adjusted when input source is Computer.

### Phase

Adjust the sampling phase to eliminate flicker.

Press  $\ominus$ . Adjust with  $\leftarrow$  / [ - ] or  $\rightarrow$  / [ + ] key.

This can be adjusted when input source is Computer.

### MPEG NR

Adjust the detail of noise reduction. Mpeg noise reduction level.

Press  $\ominus$ . Adjust with  $\leftarrow$  / [ - ] (Lower) or  $\rightarrow$  / [ + ] (Higher) key.

### Reset

Reset Advanced picture setting MENU adjustments and settings to factory default.

Press  $\ominus$ . Confirmation window will appear and select [Yes] with  $\leftarrow$  / [ - ] or  $\rightarrow$  / [ + ] key and press  $\omin�$  to reset.

## ■ Audio setting MENU

### Volume

Adjust the volume of sound.

Press  $\ominus$ . Adjust with  $\leftarrow$  / [ - ] (Lower) or  $\rightarrow$  / [ + ] (Higher) key.

### Bass

Adjust the bass level of sound.

Press  $\ominus$ . Adjust with  $\leftarrow$  / [ - ] (Lower) or  $\rightarrow$  / [ + ] (Higher) key.

### Treble

Adjust the treble level of sound.

Press  $\ominus$ . Adjust with  $\leftarrow$  / [ - ] (Lower) or  $\rightarrow$  / [ + ] (Higher) key.

### Surround

Set the surround mode of speaker output.

Press  $\ominus$ . Select from Stereo/Dolby/Concert Hall/Stadium with  $\uparrow$   $\downarrow$  / [UP] [DOWN] key.

- When Dolby is selected, surround mode are changed automatically between Dolby digital and Dolby Pro Logic II in accordance with input audio signal format.  
(Dolby digital is available only when input signal format is AC-3)

### L/R reverse

Set L channel /R channel speaker output reversed.

When this projector is used in ceiling mount or rear projection, it is recommended to speaker output reversed.

Press  $\ominus$ . Select On/Off with  $\uparrow$   $\downarrow$  / [UP] [DOWN] key.

### Center

Adjust the center speaker output level.

Press  $\ominus$ . Adjust with  $\leftarrow$  / [ - ] (Lower) or  $\rightarrow$  / [ + ] (Higher) key.

### Digital audio delay

This projector uses high quality video processing system and it takes some frames period to process. Digital audio delay can adjust the audio delay for audio-video synchronization.

Press  $\ominus$ . Adjust with  $\leftarrow$  / [ - ] (Shorter) or  $\rightarrow$  / [ + ] (Longer) key.

### Subwoofer

Adjust the sub-woofer output level.

Press  $\ominus$ . Adjust with  $\leftarrow$  / [ - ] (Lower) or  $\rightarrow$  / [ + ] (Higher) key.

### Reset

Reset Audio setting MENU adjustments and settings to factory default.

Press  $\ominus$ . Confirmation window will appear and select [Yes] with  $\leftarrow$  / [ - ] or  $\rightarrow$  / [ + ] key and press  $\ominus$  to reset.

# Using menus (Continued)

---

## ■ Setup MENU

### Language

Select a language used in menu system. The following ten languages are available.

- English
- French (Français)
- Germany (Deutsch)
- Italian (Italiano)
- Spanish (Español)
- Portuguese (Português)
- Japanese (日本語)
- Simplified Chinese (简体中文)
- Traditional Chinese (繁體中文)
- Korean (한국어)

Press . Select with / [UP] [DOWN] key.

### ■ Notes

- This setting doesn't affect DVD setup menu language. It can be selected in DVD setup menu. [p.33](#)

### H-Keystone

Correct the horizontal keystone distortion of the screen.

Press . Adjust with / [ - ] (Shrinking leftward) or / [ + ] (Shrinking rightward) key

### V-Keystone

Correct the vertical keystone distortion of the screen.

Press . Adjust with / [ - ] (Shrinking downward) or / [ + ] (Shrinking upward) key

### ■ Notes

- Depending on the amount of keystone adjustment and the content of images, some information may be lost, or the picture quality may suffer.
- Keystone adjustment will not change the shape of the menus (OSD) and the background (with no signal input).

### Lamp time reset

Reset the lamp timer to zero.

This should only be done after the lamp has been replaced.

Press . Confirmation window will appear and select [Yes] with / [ - ] or / [ + ] key and press to reset.

### Lamp power

Set the lamp power.

When lamp power is set to high, the screen becomes brighter, but the fan noise become a little increased.

Press . Select from Standard/High with / [UP] [DOWN] key.

### Fan mode

Set the cooling fan speed.

Setting fan mode to high increases the cooling fan speed. Set this option to use the projector at high altitude (over 1800 meter / 6000 feet above sea level)  
Press  $\ominus$ . Select from Standard/High with  $\blacktriangle$   $\blacktriangledown$  / [UP] [DOWN] key.

### Projection mode

Sets projection mode in accordance with placement style. [p.22](#)

The following four modes are available.

- Standard
- Ceiling (TDP-ET10 only)
- Rear
- Rear ceiling (TDP-ET10 only)

Press  $\ominus$ . Select with  $\blacktriangle$   $\blacktriangledown$  / [UP] [DOWN] key.

### Keypad light

Set keypad light on or off.

Press  $\ominus$ . Select from On/Off with  $\blacktriangle$   $\blacktriangledown$  / [UP] [DOWN] key.

### Reset

Reset Setup MENU adjustments and settings to factory default.

Press  $\ominus$ . Confirmation window will appear and select [Yes] with  $\blacktriangleleft$  / [ - ] or  $\blacktriangleright$  / [ + ] key and press  $\ominus$  to reset.

### Reset all

Resets all adjustments and settings except language to factory default.

Press  $\ominus$ . Confirmation window will appear and select [Yes] with  $\blacktriangleleft$  / [ - ] or  $\blacktriangleright$  / [ + ] key and press  $\ominus$  to reset.

## ■ Status display MENU

### Video

Display video signal information of current input signal.

### H-frequency

Display Horizontal sync frequency of current input signal.

### V-frequency

Display Vertical sync frequency of current input signal.

### Audio

Display audio signal information of current input signal.

### Lamp time by DM

Display time of lamp use.

Displays lamp time as a measure of when the lamp should be replaced. (Cannot be used as a counter of guaranteed lamp time) When displayed time approached approximate 2,000 - 3,000 hours, consult with a store about getting a TLPLET10 replacement lamp (sold separately) prepared.

# Using menus (Continued)

---

## ■ Notes

- If a lamp is used for extended periods, images will appear dark, and the lamp could burn out. This is characteristic of a lamp, and is not malfunction. (The lifetime may vary much due to conditions of use.)

## Total time

Display the total time that this projector is used.

## Version

Display firmware version.

This shows the version of the projector's internal control program. This version is referred to for customer service, etc.



**Discount-Merchant.com (800) 281-8860**  
**THE TRUSTED SOURCE FOR PROJECTOR LAMPS AND ACCESSORIES**

# About lamp

The product's light source is a mercury lamp that lights at increased internal pressure. Be sure to fully understand the following characteristics of the lamp and handle it with extreme care.

- The lamp may burst with a loud noise due to impact or deterioration, or fail to light at the expiration of its life.
- How long it takes before the lamp burst or the life expires may vary greatly by lamp. Some may burst shortly after first use.
- Burst is likely to happen if the lamp is used after the replacement period has elapsed.
- When the lamp bursts, the broken pieces of glass may get inside the product or be released outside from the openings for ventilation.
- When the lamp bursts, a slight amount of mercury gas enclosed in the lamp along with glass dust may be released from the openings for ventilation.

## ■ Immediately replace the lamp when a sign appears on the screen.

- When the projector detects that lamp life is ending, a message will appear on the screen.
- The risk of burst will increase if the lamp is continuously used without being replaced.
- Frequently check the used hours and prepare spares when the replacement time approaches. (Refer to "Status display". [p.47](#))

## ■ When the lamp is broken.

- If glass components, including a lamp and a lens, should break, handle the broken pieces with care to avoid injury and contact your dealer for repair service.
- In the event of lamp burst, unplug the product from the wall outlet, leave and completely ventilate the room. Then, thoroughly clean the area around the projector and discard any edible items placed in that area.
- When the lamp bursts, consult a doctor if glass dust or mercury gas gets into your eyes or you breathe it.

# Lamp replacement

A lamp is consumable supplies. If used for extended periods, images will appear dark, and the lamp could burn out. This is characteristic of a lamp, and is not malfunction. (The life-time of the lamp depends on condition of use). If this happens, replace it with a new one.

### WARNING

- **If the projector is mounted on the ceiling, it is recommended to use your Toshiba dealership when the lamp has to be exchanged.**

Uncovering the lamp while the projector is mounted on a ceiling may lead to a danger of damage from falling pieces of glass if the lamp is broken. Besides, working at high elevations can also be hazardous.

Do not attempt to replace the lamp by yourself.

- When replacement is required, be sure to use:

TLPLET10 (sold separately).

# Lamp replacement (Continued)

## CAUTION

- If you have been using the projector, the lamp will be very hot, and may cause burn injuries.  
Wait for the lamp to cool (for longer than 1 hour) before replacing it.
- If the lamp should break, please handle with care to avoid injury due to broken pieces and contact your dealer for repair service.

### **1** Unplug power cord.

### **2** Wait until lamp is sufficiently cooled.

Wait for at least 1 hour.

### **3** Keep the projector stationary.

Do not move the projector while replacing the lamp.

### **4** Remove the lamp cover.

Loosen the two screws and raise the lamp cover.

If necessary, use a screwdriver or other small tool to remove the cover. Use care to avoid damaging your fingers.

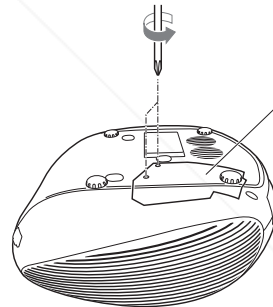

### **5** Remove the lamp.

Loosen the three lamp locking screws and pull up the handle to release the lamp. Remove the lamp.

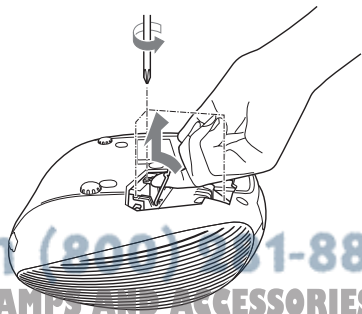

## 6 Install the new lamp.

Insert the new lamp into position and lock it into place with the three lamp locking screws.

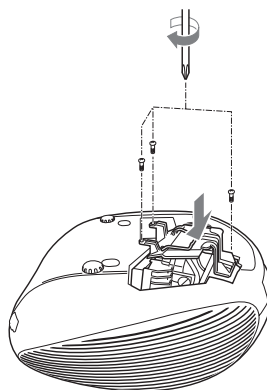

## 7 Replace the lamp cover.

Align the cover, and press it in, then tighten the screws loosened in step 4 until the lamp cover is no longer loose.

## 8 Reset the lamp timer.

Reset the lamp timer by using “lamp timer reset” in Setup menu. [p.46](#)

### ■ Notes and Precautions

- The **Lamp time** item in the **Status display** menu indicates the “estimated” time of lamp use. [p.47](#)
- Attach the lamp cover so that it is not loose. If it is not attached correctly, the projector and/or lamp may not work correctly.
- When replacing the lamp, always use a new lamp.
- The lamp is made out of glass and is fragile. Do not touch the lamp your bare fingers. Handle the lamp with a wrap or gloves. Do not drop or shake the lamp. Doing so may cause damage to the lamp.

### ■ Lamp Environmental Safety

This projector's lamp contains trace amounts of environmentally harmful inorganic

mercury. Be careful not to break new or used lamps. Dispose of used lamps in accordance with local regulations.



Discount-Merchant.com

Discount-Merchant.com (800) 281-8860

THE TRUSTED SOURCE FOR PROJECTOR LAMPS AND ACCESSORIES



# Lens and main unit cleaning

## **WARNING**

Request cleaning and maintenance of a ceiling-mounted unit from your projector dealership. Attempting to clean/replace the lamp at a high site by yourself may cause you to drop down, thus resulting in injury.

### ■ **Lens cleaning**

- Clean the lens with a commercially available blower and/or lens cleaner.
- The lens is easily scratched, so do not rub it with hard objects, or strike it.

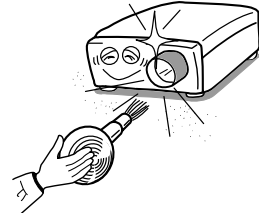

### ■ **Main unit cleaning**

- Clean the main unit after unplugging the power cord.
- Wipe dirt off the main unit gently with a soft cloth.
- If the soiling is severe, dip the cloth in a neutral detergent diluted in water, wring well, and gently wipe off the dirt, then finish up by wiping with a dry cloth.

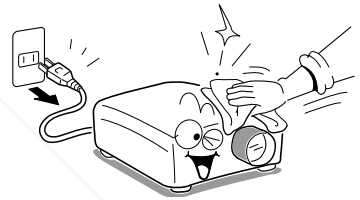

### ■ **Replacing cooling fans**

To maintain the performance, it is recommended that cooling fans should be replaced about every 2 to 3 years. Consult with your dealer for details.

# Trouble indications

The indicator lights inform you of internal abnormalities.

LED indicators	State/Problems
No LED lit	<p><b>No power</b></p> <ul style="list-style-type: none"> <li>⇒ Problem with projector               <ul style="list-style-type: none"> <li>• Unplug the power cord, and contact your dealer.</li> </ul> </li> <li>⇒ The lamp cover is not properly attached.               <ul style="list-style-type: none"> <li>• Unplug the power cord, and reattach the lamp cover.</li> </ul> </li> </ul>
Red LED is flashing at ON/STANDBY indicator (2Hz)	<p><b>Power went out during use</b></p> <ul style="list-style-type: none"> <li>⇒ Internal overheating, or the outside temperature is too high.               <ul style="list-style-type: none"> <li>• Place the projector so that the air intake and exhaust are not blocked.</li> <li>• Unplug the power cord and wait for a short while, then turn the power back on.                   <ul style="list-style-type: none"> <li>✦ The icon will appear before the power goes out.</li> <li>✦ After approx. one minute of abnormal display, the projector returns to the standby state waiting for internal cool down.</li> </ul> </li> </ul> </li> </ul>
Red LED is flashing at ON/STANDBY indicator (5Hz)	<p><b>Power went out during use</b></p> <ul style="list-style-type: none"> <li>⇒ Problem with internal cooling fan.               <ul style="list-style-type: none"> <li>• Unplug the power cord, and contact your dealer.                   <ul style="list-style-type: none"> <li>✦ The icon will appear before the power goes out.</li> <li>✦ After approx. one minute of abnormal display, the projector returns to the standby state waiting for internal cool down.</li> </ul> </li> </ul> </li> </ul>
Red LED lit at ON/STANDBY indicator	<p><b>Power went out during use, or won't come on</b></p> <ul style="list-style-type: none"> <li>⇒ Lamp temperature is high so that it is difficult to turn on, the lifetime of the lamp has ended or the projector is malfunctioning.               <ul style="list-style-type: none"> <li>• Unplug the power cord and wait for a short while, then turn the power back on.</li> <li>• If a lamp burns out, replace it with a new one.                   <ul style="list-style-type: none"> <li>✦ After approx. one minute of abnormal display, the projector returns to the standby state waiting for internal cool down.</li> </ul> </li> </ul> </li> </ul>

# Before calling service personnel

If you think something is wrong, check the followings before contacting customer service. Please see “**Trouble indications**” [p.53](#) as well.

If This Happens	Check
<b>No Power</b>	<ul style="list-style-type: none"> <li>• Is the power cord plugged in? Is it connected to the projector?</li> <li>• Is the lamp cover loose?</li> </ul>
<b>The projector won't be activate</b>	<ul style="list-style-type: none"> <li>• Is pressing &amp; releasing ON/STANDBY key too quick? Press the ON/STANDBY key on control panel for 3~5 seconds &amp; release while the red LED is still lit.</li> </ul>
<b>Power goes out during use</b>	<ul style="list-style-type: none"> <li>• Is the ambient temperature high?</li> <li>• Is the air intake or air exhaust blocked?</li> </ul>
<b>No picture</b>	<ul style="list-style-type: none"> <li>• Is the projector turned on?</li> <li>• Is the mute function on?</li> <li>• Is the brightness setting minimized?</li> <li>• Are the connections set up correctly?</li> <li>• Are all the connected devices functioning properly?</li> </ul>
<b>No audio</b>	<ul style="list-style-type: none"> <li>• Is the projector turned on?</li> <li>• Is the mute function on?</li> <li>• Is the volume setting minimized?</li> <li>• Are the connections set up correctly?</li> <li>• Are all the connected devices functioning properly?</li> </ul>
<b>Picture not displayed correctly</b>	<ul style="list-style-type: none"> <li>• Is the input signal supported by the projector?</li> <li>• Is there something generating an abnormal video signal, for instance the video tape?</li> </ul>
<b>Picture blurred Part of picture out of focus</b>	<ul style="list-style-type: none"> <li>• Is the lens dirty?</li> <li>• Is the lens focus adjusted optimally?</li> <li>• Is the projection distance within the projector's supported range?</li> <li>• Is the projector's screen placement angle tilted too far?</li> <li>• Is the sharpness or sampling phase adjustments off?</li> </ul>
<b>Image is dark</b>	<ul style="list-style-type: none"> <li>• Is the brightness or contrast adjustments off?</li> <li>• Is the lamp nearing the end of its service life?</li> </ul>
<b>Remote control doesn't work</b>	<ul style="list-style-type: none"> <li>• Are the remote control's batteries drained?</li> <li>• Are the batteries inserted into the remote control correctly?</li> <li>• Is the remote control being used within the effective range?</li> <li>• Are there any obstructions between the remote control and projector?</li> <li>• Are there any fluorescent or other bright lights shining at the projector's infrared remote sensor?</li> </ul>

FixYourDLP.com  
Sponsored by DM

Discount-M... (800) 281-8860

THE TRUSTED SOURCE FOR PROJECTOR LAMPS AND ACCESSORIES

**For TDP-ET20**

If This Happens	Check
<p><b>Playback does not start</b></p>	<ul style="list-style-type: none"> <li>• Is the disc inserted?</li> <li>• Is the disc inserted upside down?</li> <li>• Is an unplayable disc inserted?</li> <li>• Is the disc dirty?</li> <li>• Is the parental lock function set?</li> </ul>
<p><b>The playback picture has occasional distortion.</b></p>	<ul style="list-style-type: none"> <li>• Is the disc dirty?</li> <li>• Is the play mode in fast forward or fast reverse playback?</li> </ul>
<p><b>Playback does not follow the course of the disc's programs</b></p>	<ul style="list-style-type: none"> <li>• Is it in the mode of repeat playback or random playback?</li> </ul>
<p><b>DVD operation keys do not work</b></p>	<ul style="list-style-type: none"> <li>• Power supply fluctuation or other abnormalities such as static electricity may interrupt correct operations. Press <b>■</b> / <b>▲</b> key for 5 seconds, and then DVD player will eject the disc. If DVD player still don't work, turn OFF the POWER, disconnect and then reconnect the AC power cord, and turn ON the projector again.</li> </ul>

# Specification

## ■ List of general specifications

Item	Specification	
Consumption Power	340 W	
Input Rating	100~240V AC, 50~60 Hz, 4.0A	
Weight	4.8 kg (TDP-ET10) 5.0 kg (TDP-ET20)	
External Dimensions	321 x 154 x 344 mm (W × H × D)	
Cabinet material	PC+ABS resin	
Conditions for usage environment	Temp: 5°C to 35°C; relative humidity: 30% to 70%	
Display pixels	1 chip DMD™	
Picture elements	409, 920 pixels (854H x 480V)	
Lens	F=2.6 f=7.56 mm	
Lamp	High-pressure mercury lamp (230 W)	
Projection screen size	38~134 inches	
Projection distance	0.5~1.9 meters	
DVD player (for TDP-ET20)	12.7mm-high Slim type, slot load mechanism	
Built-in 5.1 Speakers	Sub woofer 5W Front 1.5W Rear/Center 2.5W	
Connection terminal	Control terminal	Serial: Dsub 9 pin
	Computer IN terminal	Mini D sub 15 pin RGB
	Component (Y/Pb/Pr) IN terminal	Y: RCA Pin Jack 1 V (p-p), 75Ω Pb: RCA Pin Jack 0.7 V (p-p), 75Ω Pr: RCA Pin Jack 0.7 V (p-p), 75Ω
	S-Video IN terminal	Mini DIN 4 pin
	VIDEO IN terminal	RCA Pin Jack 1 V (p-p), 75Ω
	Digital AV IN terminal	HDMI terminal type A
	Analog audio IN terminal	3.5mm dia. stereo mini-jack, 1.5 V (rms)
	Digital audio IN terminal	Coaxial IN: 0.5 V (p-p), 75 Ω
	Digital audio OUT terminal	Coaxial OUT: 0.5 V (p-p), 75 Ω

## ■ Note

Design and specifications are subject to change without notice. This model may not be compatible with features and/or specifications that may be added in the future.

■ Separately sold product Replacement Lamp Model TLPLET10.

THE TRUSTED SOURCE FOR PROJECTOR LAMPS AND ACCESSORIES

■ **List of supported signals (Y/Pb/Pr signals)**

Signal format	fh (kHz)	fv (Hz)
480i(525i)@60Hz	15.73	59.94
480p(525p)@60Hz	31.47	59.94
576i(625i)@50Hz	15.63	50.00
576p(625p)@50Hz	31.25	50.00
720p(750p)@60Hz	45.00	60.00
720p(750p)@50Hz	37.50	50.00
1080i(1125i)@60Hz	33.75	60.00
1080i(1125i)@50Hz	28.13	50.00

■ **List of supported signals (Video, S-Video signals)**

Video mode	fh (kHz)	fv (Hz)	fsc (MHz)
NTSC	15.73	60	3.58
PAL	15.63	50	4.43
SECAM	15.63	50	4.25 or 4.41
PAL-M	15.73	60	3.58
PAL-N	15.63	50	3.58
PAL-60	15.73	60	4.43
NTSC4.43	15.73	60	4.43

# Specification (Continued)

## ■ CONTROL terminal

Conditioning of the projection unit can be also done by a computer via the RS-232C.

### ● Pin assignment

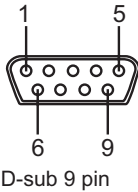

Pin No.	Signal Name	Description
1	N.C	No connection
2	RXD	Receiving data
3	TXD	Sending data
4	DTR	Data terminal ready
5	GND	Signal ground
6	DSR	Data set ready
7	RTS	Request to send
8	CTS	Consent to send
9	N.C	No connection

### ● Interface format

1. Communication method RS-232C, 9600bps, No Parity, Data Length: 8 bits; Stop Bit Length: 1 bit

2. Communication format

STX (02h)	Command (3Byte)	ETX (03h)
-----------	-----------------	-----------

Only 1 command valid per communication.

3. Data format For input commands, only ASCII-compliant all-uppercase alphanumeric characters supported.

4. Replies

Acknowledge	ACK (06h)	CR (0Dh)	Data	... Normally ended
	ACK (06h)	ESC (1Bh)		... Aborted
No acknowledge	NAK (15h)			

If commands are to be sent consecutively, wait for the response from the projector before sending the next command.

### ● Main Commands

Item	Command	Item	Command
DVD play	DPL	Input Component	IN2
DVD stop	DST	Input HDMI	IN3
Vol. up	VLU	Input Video	IN9
Vol. down	VLD	Input S-video	INA
Input Computer	IN1	Input DVD	INB

### ■ Note

- Contact your dealer for control cable and other commands.

**TOSHIBA CORPORATION**



FixYourDLP.com

Sponsored by  DM

**Discount-Merchant.com (800) 281-8860**

**THE TRUSTED SOURCE FOR PROJECTOR LAMPS AND ACCESSORIES**





# Disclaimer

This user manual is provided as a free service by FixYourDLP.com. FixYourDLP is in no way responsible for the content of this manual, nor do we guarantee its accuracy. FixYourDLP does not make any claim of copyright and all copyrights remain the property of their respective owners.

About FixYourDLP.com

FixYourDLP.com (<http://www.fixyourdpl.com>) is the World's #1 resource for media product news, reviews, do-it-yourself guides, and manuals.

Informational Blog: <http://www.fixyourdpl.com>

Video Guides: <http://www.fixyourdpl.com/guides>

User Forums: <http://www.fixyourdpl.com/forum>

FixYourDLP's Fight Against Counterfeit Lamps:

<http://www.fixyourdpl.com/counterfeits>

## Sponsors:

RecycleYourLamp.org – Free lamp recycling services for used lamps:

<http://www.recycleyourlamp.org>

Lamp Research - The trusted 3rd party lamp research company:

<http://www.lampresearch.com>

Discount-Merchant.com – The worlds largest lamp distributor:

<http://www.discount-merchant.com>



**FixYourDLP.com**

Sponsored by 