



Disclaimer

This user manual is provided as a free service by FixYourDLP.com. FixYourDLP is in no way responsible for the content of this manual, nor do we guarantee its accuracy. FixYourDLP does not make any claim of copyright and all copyrights remain the property of their respective owners.

About FixYourDLP.com

FixYourDLP.com (<http://www.fixyourdlp.com>) is the World's #1 resource for media product news, reviews, do-it-yourself guides, and manuals.

Informational Blog: <http://www.fixyourdlp.com>

Video Guides: <http://www.fixyourdlp.com/guides>

User Forums: <http://www.fixyourdlp.com/forum>

FixYourDLP's Fight Against Counterfeit Lamps:

<http://www.fixyourdlp.com/counterfeits>

Sponsors:

RecycleYourLamp.org – Free lamp recycling services for used lamps:

<http://www.recycleyourlamp.org>

Lamp Research - The trusted 3rd party lamp research company:

<http://www.lampresearch.com>

Discount-Merchant.com – The worlds largest lamp distributor:

<http://www.discount-merchant.com>



FixYourDLP.com

Sponsored by 

TOSHIBA

OWNER'S MANUAL

3LCD DATA PROJECTOR

TLP-X10U

TLP-X11U *(WITH DOCUMENT IMAGING CAMERA)*

TLP-X20U

TLP-X21U *(WITH DOCUMENT IMAGING CAMERA)*

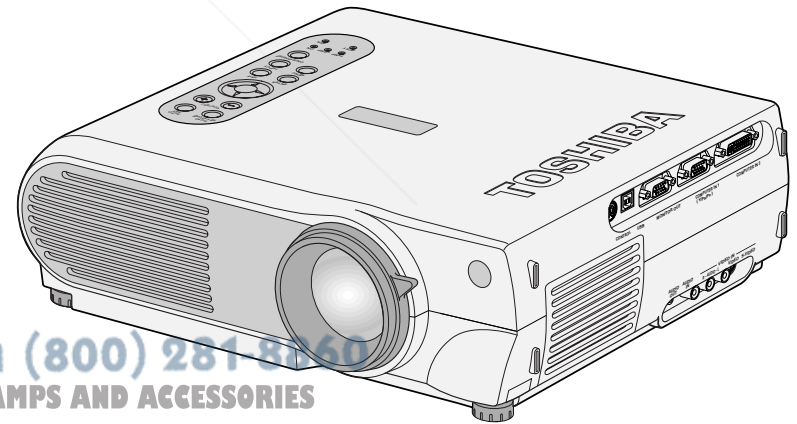

Discount-Merchant.com (800) 281-8860
THE TRUSTED SOURCE FOR PROJECTOR LAMPS AND ACCESSORIES

TLP-X10U

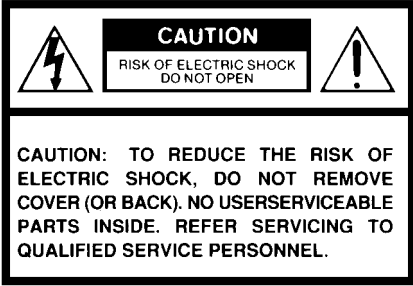

The lightning flash with arrowhead symbol, within an equilateral triangle, is intended to alert the user to the presence of uninsulated “dangerous voltage” within the product’s enclosure that may be of sufficient magnitude to constitute a risk of electric shock to persons.



The exclamation point within an equilateral triangle is intended to alert the user to the presence of important operating and maintenance (servicing) instructions in the literature accompanying the appliance.

WARNING: TO REDUCE THE RISK OF FIRE OR ELECTRIC SHOCK, DO NOT EXPOSE THIS APPLIANCE TO RAIN OR MOISTURE. DANGEROUS HIGH VOLTAGES ARE PRESENT INSIDE THE ENCLOSURE. DO NOT OPEN THE CABINET. REFER SERVICING TO QUALIFIED PERSONNEL ONLY.

FCC Radio Frequency Interference Statement

Note: This equipment has been tested and found to comply with the limits for a Class A digital device, pursuant to part 15 of the FCC Rules. These limits are designed to provide reasonable protection against harmful interference when the equipment is operated in a commercial environment. This equipment generates, uses, and can radiates radio frequency energy and, if not installed and used in accordance with the instruction manual, may cause harmful interference to radio communications. Operation of this equipment in a residential area is likely to cause harmful interference in which case the user will be required to correct the interference at his own expense.

WARNING: Changes or modifications made to this equipment, not expressly approved by Toshiba, or parties authorized by Toshiba, could void the user’s authority to operate the equipment.

Notice: This Class A digital apparatus complies with Canadian ICES-003. Cet appareil numérique de la classe A est conforme à la norme NMB-003 du Canada.

CAUTION: Laser beam is emitted when the laser button of the remote control is pressed. Do not look from the front of the remote control. Do not face toward a person or to a mirror.



Save Original Packing Materials

The original shipping carton and packing materials will come in handy if you ever have to ship your LCD projector. For maximum protection, repack the set as it was originally packed at the factory.

Avoid Volatile Liquid

Do not use volatile liquids, such as an insect spray, near the unit. Do not leave rubber or plastic products touching the unit for a long time. They will mar the finish.

Moisture Condensation

Never operate this unit immediately after moving it from a cold location to a warm location. When the unit is exposed to such a change in temperature, moisture may condense on the crucial internal parts. To prevent the unit from possible damage, do not use the unit for at least 2 hours when there is an extreme or sudden change in temperature.

In the spaces provided below, record the Model and Serial No. located at the bottom of your LCD projector.

Model No. _____ Serial No. _____

Retain this information for future reference.



CAUTION: PLEASE READ AND OBSERVE ALL WARNINGS AND INSTRUCTIONS GIVEN IN THIS OWNER'S MANUAL AND THOSE MARKED ON THE UNIT. RETAIN THIS BOOKLET FOR FUTURE REFERENCE.

This set has been designed and manufactured to assure personal safety. Improper use can result in electric shock or fire hazard. The safeguards incorporated in this unit will protect you if you observe the following procedures for installation, use and servicing. This unit is fully transistorized and does not contain any parts that can be repaired by the user.

DO NOT REMOVE THE CABINET COVER, OR YOU MAY BE EXPOSED TO DANGEROUS VOLTAGE. REFER SERVICING TO QUALIFIED SERVICE PERSONNEL ONLY.

1. Read Owner's Manual

After unpacking this product, read the owner's manual carefully, and follow all the operating and other instructions.

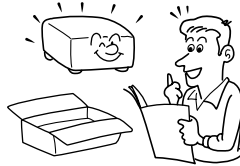

2. Power Sources

This product should be operated only from the type of power source indicated on the marking label. If you are not sure of the type of power supply to your home, consult your product dealer or local power company. For products intended to operate from battery power, or other sources, refer to the operating instructions.



3. Source of Light

Do not look into the lens while the lamp is on. The strong light from the lamp may cause damage to your eyes or sight.

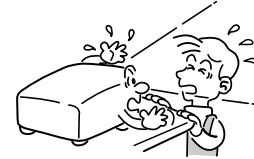

4. Ventilation

Openings in the cabinet are provided for ventilation and to ensure reliable operation of the product and to protect it from overheating, and these openings must not be blocked or covered. The openings should never be blocked by placing the product on a bed, sofa, rug or other similar surface. This product should not be placed in a built-in installation such as a bookcase or rack unless proper ventilation is provided or the manufacturer's instructions have been adhered to.



Discount-Merchants.com (800) 281-8869
THE TRUSTED SOURCE FOR PROJECTOR LAMPS AND ACCESSORIES

5. Heat

The product should be situated away from heat sources such as radiators, heat registers, stoves, or other products (including amplifiers) that produce heat.

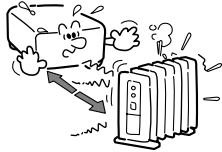

7. Cleaning

Unplug this product from the wall outlet before cleaning. Do not use liquid cleaners or aerosol cleaners. Use a damp cloth for cleaning.

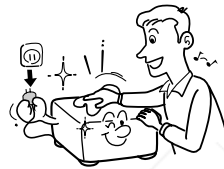

9. Overloading

Do not overload wall outlets; extension cords, or integral convenience receptacles as this can result in a risk of fire or electric shock.

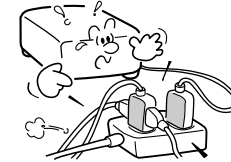

6. Water and Moisture

Do not use this product near water – for example, near a bath tub, wash bowl, kitchen sink, or laundry tub; in a wet basement; or near a swimming pool and the like.

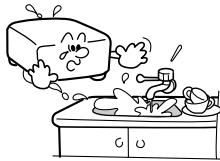

8. Power-Cord Protection

Power-supply cords should be routed so that they are not likely to be walked on or pinched by items placed upon or against them, paying particular attention to cords at plugs, convenience receptacles, and the point where they exit from the product.



10. Lightning

For added protection for this product during storm, or when it is left unattended and unused for long periods of time, unplug it from the wall outlet. This will prevent damage to the product due to lightning and power-line surges.



Discount-Merchant.com (800) 281-8860
THE TRUSTED SOURCE FOR PROJECTOR LAMPS AND ACCESSORIES

11. Object and Liquid Entry

Never push objects of any kind into this product through openings as they may touch dangerous voltage points or short-out parts that could result in a fire or electric shock. Never spill liquid of any kind on the product.



13. Stack Inhibited

Do not stack other equipment on this product or do not place this product on the other equipment. Top and bottom plates of this product develops heat and may give some undesirable damage to other unit.

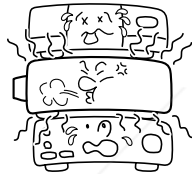

12. Do not place the product vertically

Do not use the product in the upright position to project the pictures at the ceiling, or any other vertical positions. It may fall down and dangerous.

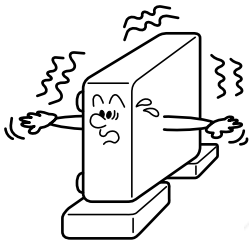

14. Attachments

Do not use attachments not recommended by the product manufacturer as they may cause hazards.



15. Accessories

Do not place this product on an unstable cart, stand, tripod, bracket, or table. The product may fall, causing serious injury to a child or adult, and serious damage to the product. Use only with a cart, stand, tripod, bracket, or table recommended by the manufacturer, or sold with the product. Any mounting of the product should follow the manufacturer's instructions, and should use a mounting accessory recommended by the manufacturer. A product and cart combination should be moved with care. Quick stops, excessive force, and uneven surfaces may cause the product and cart combination to overturn.



Discount-Merchant.com (800) 281-8860
THE TRUSTED SOURCE FOR PROJECTOR LAMPS AND ACCESSORIES

16. If glass components, including lens and lamp, should break, contact your dealer for repair service.

This product incorporates glass components, including a lens and a lamp. If such parts should break, please handle with care to avoid injury and contact your dealer for repair service. The broken pieces of glass may cause to injury.

In the unlikely event of the lamp rupturing, thoroughly clean the area around the projector and discard any edible items placed in that area.

17. Damage Requiring Service

Unplug this product from the wall outlet and refer servicing to qualified service personnel under the following conditions:

- a) When the power-supply cord or plug is damaged.
- b) If liquid has been spilled, or objects have fallen into the product.
- c) If the product has been exposed to rain or water.
- d) If the product does not operate normally by following the operating instructions. Adjust only those controls that are covered by the operating instructions as an improper adjustment of other controls may result in damage and will often require extensive work by a qualified technician to restore the product to its normal operation.
- e) If the product has been dropped or damaged in any way.
- f) When the product exhibits a distinct change in performance – this indicates a need for service.

18. Servicing

Do not attempt to service this product yourself as opening or removing covers may expose you to dangerous voltage or other hazards. Refer all servicing to qualified service personnel.



19. Replacement Parts

When replacement parts are required, be sure the service technician has used replacement parts specified by the manufacturer or have the same characteristics as the original part. Unauthorized substitutions may result in fire, electric shock, or other hazards. (Replacement of the lamp only should be made by users.)



Discount-Merchant.com (800) 281-8860
THE TRUSTED SOURCE FOR PROJECTOR LAMPS AND ACCESSORIES

20. Safety Check

Upon completion of any service or repairs to this product, ask the service technician to perform safety checks to determine that the product is in proper operating condition.



22. Do not carry by the camera arm.

Do not carry the projector by the camera arm. Doing so can result in damage or injury.



24. Do not move the projector while the arm is still erect.

Always store the arm back in position when moving the projector. Otherwise injury or damage may result.



21. Do not get your hands between the camera arm and the main unit when setting the camera arm back in its original position.

To avoid injury, be careful not to get your hands caught when setting the camera arm back in its original position. Families with children should be particularly careful.

23. Do not leave documents on the unit for long periods of time while using the document imaging function.

Do not leave texts, papers or other documents for projection on the unit for long periods of time. The heat could erase the letters on a thermal paper.

25. Do not look into the arm light while it is lit.

The strong light may cause damage to your eyes or sight.



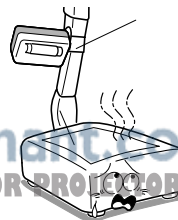

Discount-Merchants.com (800) 281-8860
THE TRUSTED SOURCE FOR PROJECTOR LAMPS AND ACCESSORIES



Power supply cord selection

If your line voltage is 220 to 240V, use one of the following types of cable.

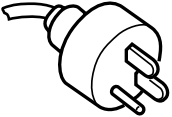
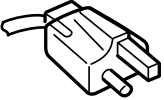
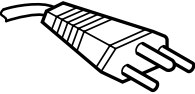
| Plug configuration | Plug type | Line voltage |
|------------------------------------------------------------------------------------|-------------------------------|--------------|
|  | EURO 240V 10 – 15A | 220 – 240V |
|  | UK 240V 6A | 200 – 240V |
|  | Australian 240V 10A | 200 – 240V |
|  | North American 240V 15A | 200 – 240V |
|  | Switzerland 240V 6A | 200 – 240V |



Discount-Merchant.com (800) 281-8860
THE TRUSTED SOURCE FOR PROJECTOR LAMPS AND ACCESSORIES

Before use

| | |
|-------------------------------------------------------|----|
| <i>SAFETY PRECAUTIONS</i> | 2 |
| <i>IMPORTANT PRECAUTIONS</i> | 3 |
| <i>IMPORTANT SAFETY INSTRUCTIONS</i> | 4 |
| <i>Power supply cord selection</i> | 9 |
| <i>Contents</i> | 10 |
| <i>Names of each part on the main unit</i> | 11 |
| <i>Names of each part on the remote control</i> | 14 |
| <i>Loading batteries</i> | 15 |
| <i>Remote control operation</i> | 16 |

Installation and connections

| | |
|--------------------------------------------------------------|----|
| <i>Floor-mounted projector placement</i> | 17 |
| <i>Projector placement angle adjustment</i> | 20 |
| <i>Ceiling-mounted projector placement</i> | 21 |
| <i>Connecting a computer</i> | 22 |
| <i>Connecting a computer with DVI output connector</i> | 23 |
| <i>Connecting video equipment</i> | 24 |
| <i>Projector operation control by a computer</i> | 26 |
| <i>How to use the output connector</i> | 27 |

Operations

| | |
|---------------------------------------------------------|----|
| <i>Projection on the screen</i> | 28 |
| <i>Turning the power off</i> | 31 |
| <i>Adjusting the picture automatically</i> | 32 |
| <i>Correcting the keystone distortion</i> | 33 |
| <i>Cutting off the picture and temporarily</i> | 34 |
| <i>Freezing the picture</i> | 35 |
| <i>Enlarging the picture size</i> | 36 |
| <i>Displaying PIP Sub-pictures</i> | 37 |
| <i>Displaying Information</i> | 38 |
| <i>Operating a computer by the remote control</i> | 39 |
| <i>Projecting images stored in a memory card</i> | 40 |

Adjustments & Settings

| | |
|-----------------------------------------------------------|----|
| <i>Adjustments and settings on the menu screen</i> | 45 |
| <i>Operating the menu screen</i> | 47 |
| <i>QUICK MENU adjustments and settings</i> | 48 |
| <i>FULL MENU adjustments and settings – Picture</i> | 54 |
| <i>FULL MENU settings – Audio</i> | 60 |
| <i>FULL MENU settings – Keystone</i> | 62 |
| <i>FULL MENU settings – Display</i> | 64 |
| <i>FULL MENU settings – Default setting</i> | 67 |
| <i>FULL MENU settings – Factory reset mode</i> | 71 |
| <i>PIP menu setting</i> | 73 |

Document imaging camera

| | |
|---------------------------------------------------------------|----|
| <i>Part names (of the document imaging camera model)</i> .. | 74 |
| <i>Preparation of the document imaging camera</i> | 75 |
| <i>Picture projection with the document imaging camera</i> .. | 76 |
| <i>Lock the white balance</i> | 79 |
| <i>Correcting illuminated defects</i> | 80 |
| <i>Store the camera images into the memory card</i> | 81 |

Maintenance

| | |
|------------------------------------------|----|
| <i>Trouble indications</i> | 82 |
| <i>Air filter cleaning</i> | 83 |
| <i>Lens and main unit cleaning</i> | 85 |
| <i>Lamp replacement</i> | 86 |

Others

| | |
|-------------------------------------------------------------------|-----|
| <i>Before calling service personal</i> | 88 |
| <i>Pin assignment of COMPUTER IN, MONITOR OUT connector</i> | 90 |
| <i>Applicable signal</i> | 91 |
| <i>Controlling the projector by using RS-232C</i> | 93 |
| <i>Specifications</i> | 99 |
| <i>LIMITED WARRANTY</i> | 101 |

Discount-Merchant.com (001) 888-8888
THE TRUSTED SOURCE FOR PROJECTOR PARTS AND ACCESSORIES

Names of each part on the main unit

CAUTION

Openings in the cabinet are provided for ventilation and to ensure reliable operation of the product and to protect it from overheating, and these openings must not be blocked or covered.

The explanation here is only for the model not with the document imaging camera. For the model with the document imaging camera, refer to **74**.

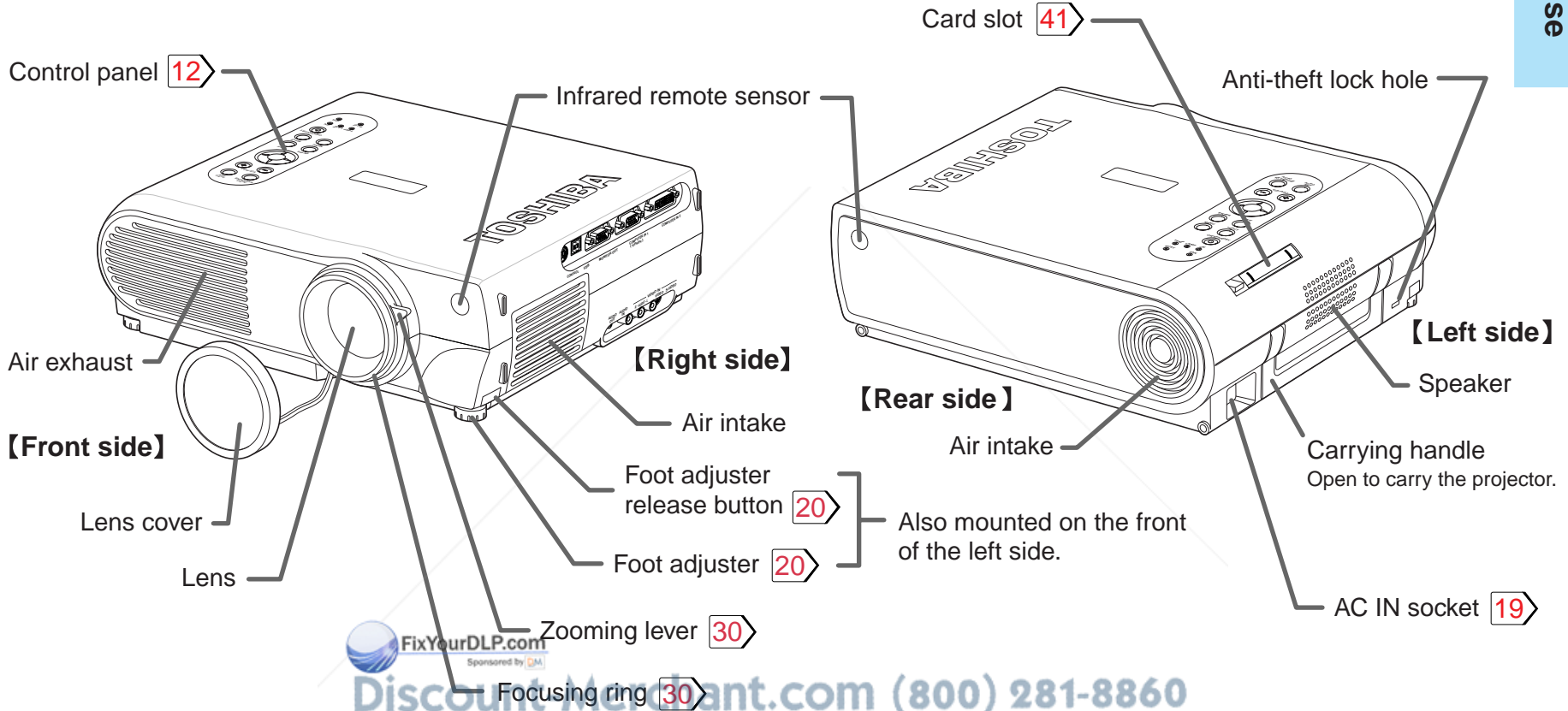

FixYourDLP.com
Sponsored by
DiscountMerchant.com (800) 281-8860
THE TRUSTED SOURCE FOR PROJECTOR LAMPS AND ACCESSORIES

Note

The air exhaust discharges high temperature air. Do not put something around the air exhaust, otherwise it may be deformed by the high temperature air.

Continued

Names of each part on the main unit (continued)

Before use

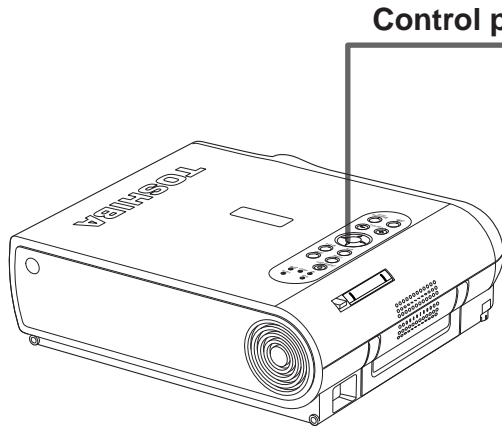

Control panel

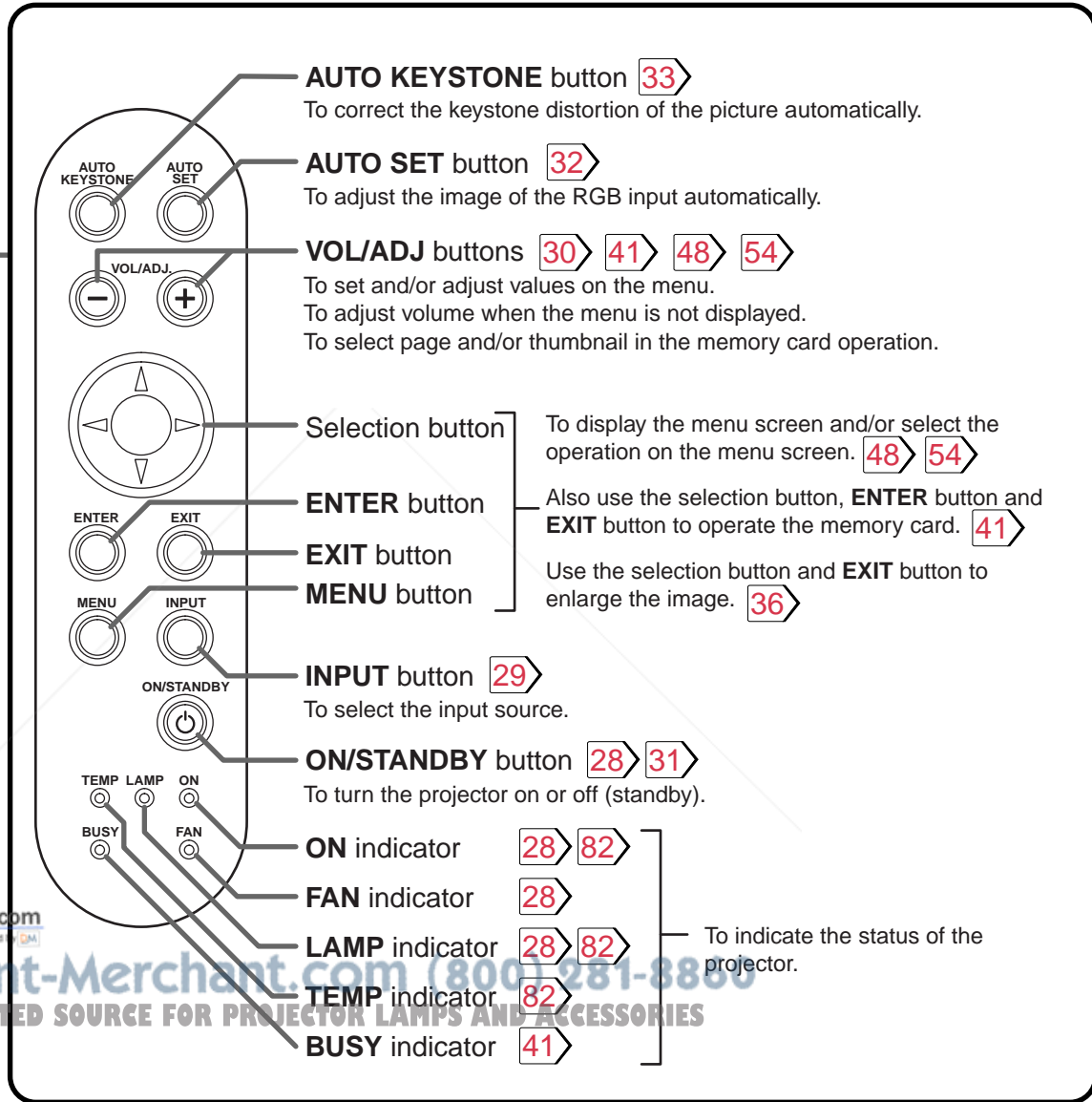

FixYourDLP.com
Sponsored by DPA
Discount-Merchant.com (800) 281-8850
THE TRUSTED SOURCE FOR PROJECTOR LAMPS AND ACCESSORIES

Names of each part on the main unit (continued)

Before use

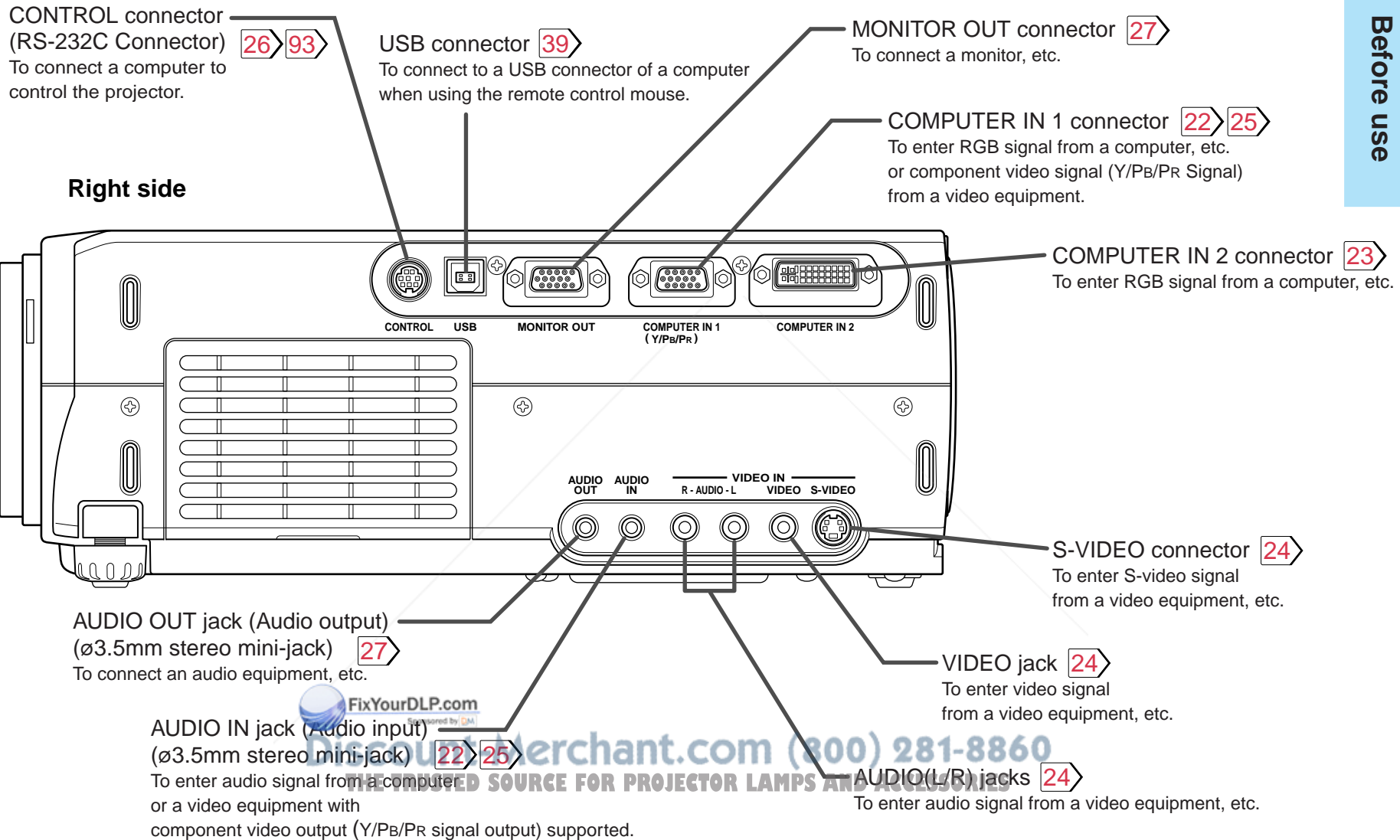

FixYourDLP.com
Discounter.com (800) 281-8860
THE UNDISPUTED SOURCE FOR PROJECTOR LAMPS AND ACCESSORIES

Names of each part on the remote control

Caution - use of controls or adjustments or performance of procedures other than those specified herein may result in hazardous radiation exposure.

Location of the labels

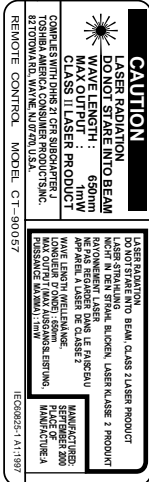
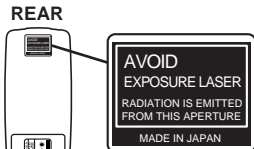
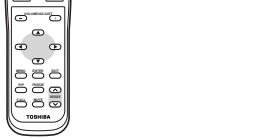

INPUT button

To select the input source.

AUTO KEYSTONE button

To correct the keystone distortion of the picture automatically.

Pointer control button

R-CLICK button

L-CLICK button

To use as USB remote control mouse.

PIP button

To display the video input image as a small size picture in the computer image display window.

FREEZE button

To freeze the picture.

CALL button

To display the information.

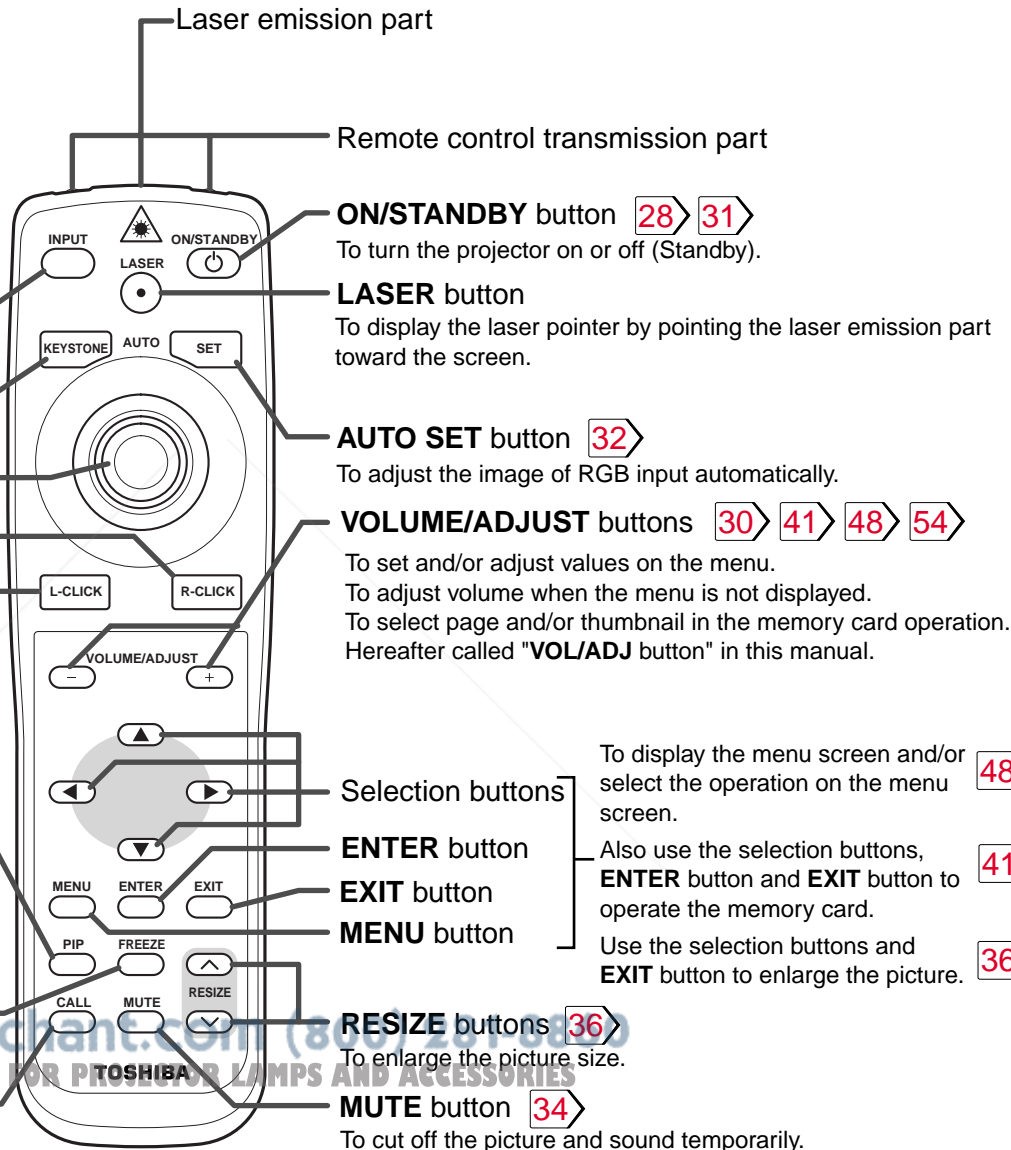

Laser emission part

Remote control transmission part

ON/STANDBY button 28 31

To turn the projector on or off (Standby).

LASER button

To display the laser pointer by pointing the laser emission part toward the screen.

AUTO SET button 32

To adjust the image of RGB input automatically.

VOLUME/ADJUST buttons 30 41 48 54

To set and/or adjust values on the menu.
To adjust volume when the menu is not displayed.
To select page and/or thumbnail in the memory card operation.
Hereafter called "VOL/ADJ button" in this manual.

Selection buttons

To display the menu screen and/or select the operation on the menu screen. 48 54

ENTER button

Also use the selection buttons, **ENTER** button and **EXIT** button to operate the memory card. 41

EXIT button

MENU button

Use the selection buttons and **EXIT** button to enlarge the picture. 36

RESIZE buttons 36

To enlarge the picture size.

MUTE button 34

To cut off the picture and sound temporarily.

FixYourDLP.com
Discount-Merchant.com (800) 451-5151
THE TRUSTED SOURCE FOR PROJECTOR LAMPS AND ACCESSORIES

Notes

Using batteries incorrectly can cause them to leak or burst. Strictly observe the following.

- Install the batteries with their + and – ends facing correctly.
- Do not charge, heat, disassemble, or short the batteries or throw them into a fire.
- Do not leave exhausted batteries in the remote control.
- Do not mix different types of batteries or new and old batteries.
- When you will not be using the remote control for a prolonged period, take the batteries out of the remote control.
- When the remote control stops working or only works from very close distance, replace all the batteries with new ones.
- When replacing the batteries, use a more longer life alkaline batteries.
- If a battery leaks, carefully wipe off any residue inside the battery case before loading new batteries.

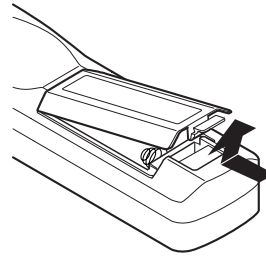
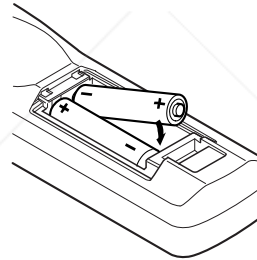
1**Open the cover.****2****Install the batteries.**

Make sure that the +/- polarities match the illustration in the compartment.

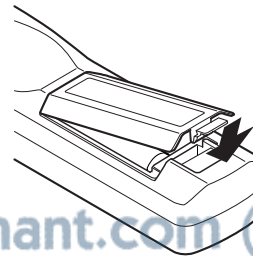
3**Attach the cover.**

Remote control operation

Point the remote control at the infrared remote sensor and press a button.

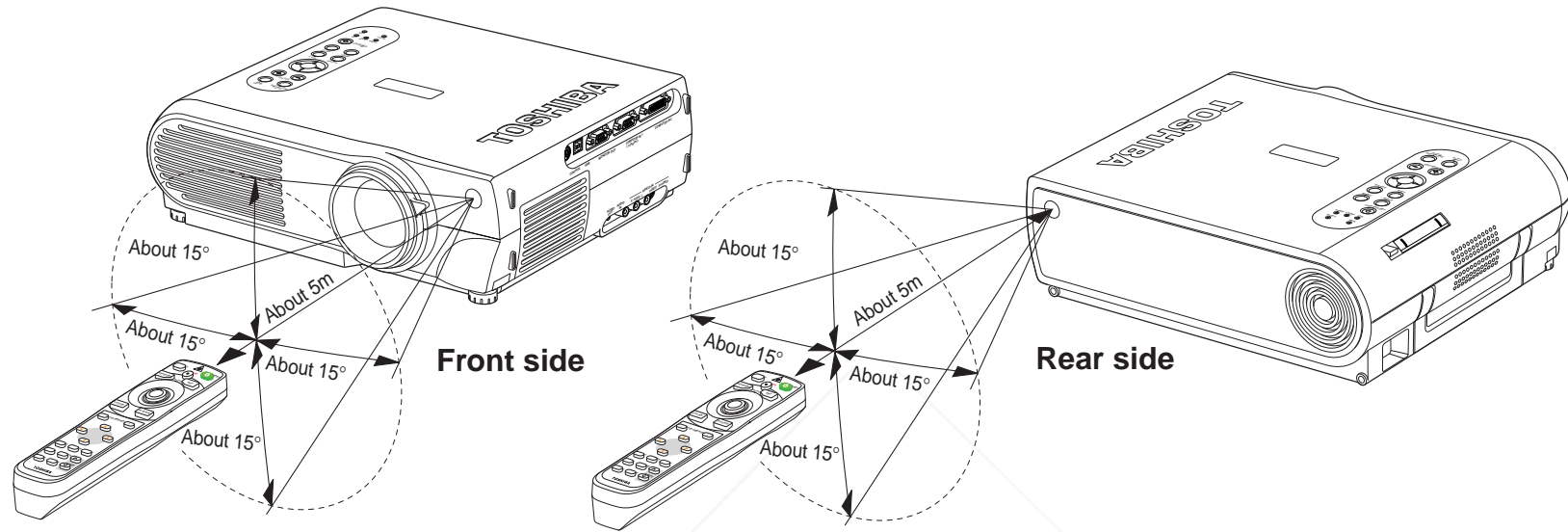

Notes

- The remote control may not operate when there is sunlight or other strong light such as a fluorescent lamp shining on the remote sensor.
- Operate the remote control from a position where the remote sensor is visible.
- Do not drop the remote control or otherwise jolt it.
- Keep the remote control out of locations with excessively high temperature or humidity.
- Do not get water on the remote control or place wet objects on it.
- Do not disassemble the remote control.
- Under unusual circumstances the remote control may not operate well due to the location being used or the surroundings. At such times, change the direction of the remote control to the projector and retry the operation.

Floor-mounted projector placement

There are two ways to place the floor-mounted projector. Perform the “Projection mode” setting on the menu screen for the projection method. [67](#)

For the ceiling-mounted projector placement, refer to the page [21](#).

Floor-mounted front projection

Viewing a picture projected on the front of the screen from a floor installation.

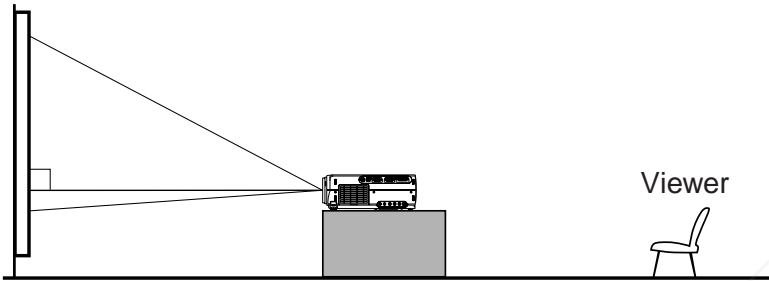

Floor-mounted rear projection

Viewing a picture projected through the back of the screen from a floor installation.

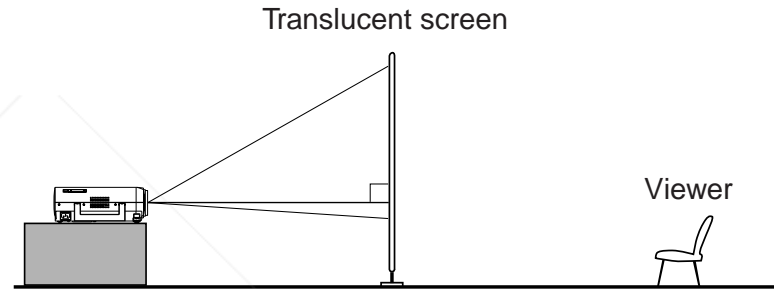

Discount-Merchant.com (800) 281-8860
THE TRUSTED SOURCE FOR PROJECTOR LAMPS AND ACCESSORIES

1 Place the projector on a steady, level surface such as a table.

To obtain proper screen projected, place the projector so that the projecting light hits the screen squarely.

Top view

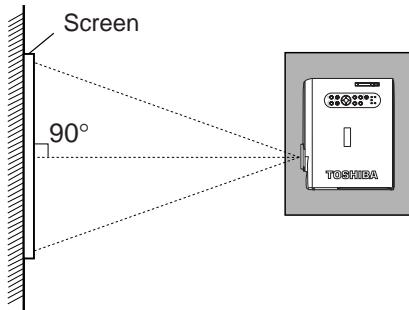

Point the lens straight at the center of the screen as above.

Side view

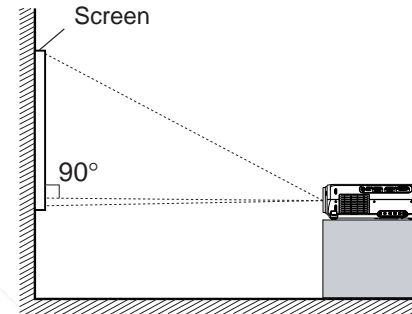

Place the projector horizontally so that the projecting light hits the screen squarely.

2 Determine the screen size projected on the screen.

The projection size depends on the distance between the lens and the screen. Adjust the projection size by changing the distances as shown below.

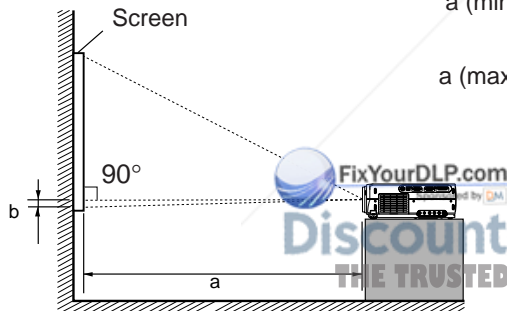

$$a \text{ (min.)} = \frac{\text{Projection size} - 0.9345}{27.343}$$

$$a \text{ (max.)} = \frac{\text{Projection size} - 0.7301}{21.362}$$

$$b = \text{Projection size (cm)} \times 0.06$$

- a: Distance between the lens and the screen (m)
- b: Distance between the lens height and the bottom of projection area (cm)

| Projection size (inches) | a (m) | | b (cm) |
|--------------------------|---------------------------|---------------------------|--------|
| | Minimum (At maximum zoom) | Maximum (At minimum zoom) | |
| 25 | — | 1.14 | 3.8 |
| 40 | 1.43 | 1.84 | 6.1 |
| 60 | 2.16 | 2.77 | 9.1 |
| 80 | 2.89 | 3.71 | 12.2 |
| 100 | 3.62 | 4.65 | 15.2 |
| 150 | 5.45 | 6.99 | 22.9 |
| 200 | 7.28 | 9.33 | 30.5 |
| 250 | 9.11 | — | 38.1 |

• The values are approximations.

3 Connect the power cord.

- Insert one end in the AC IN socket on the projector.
- Insert the other end in a wall outlet.

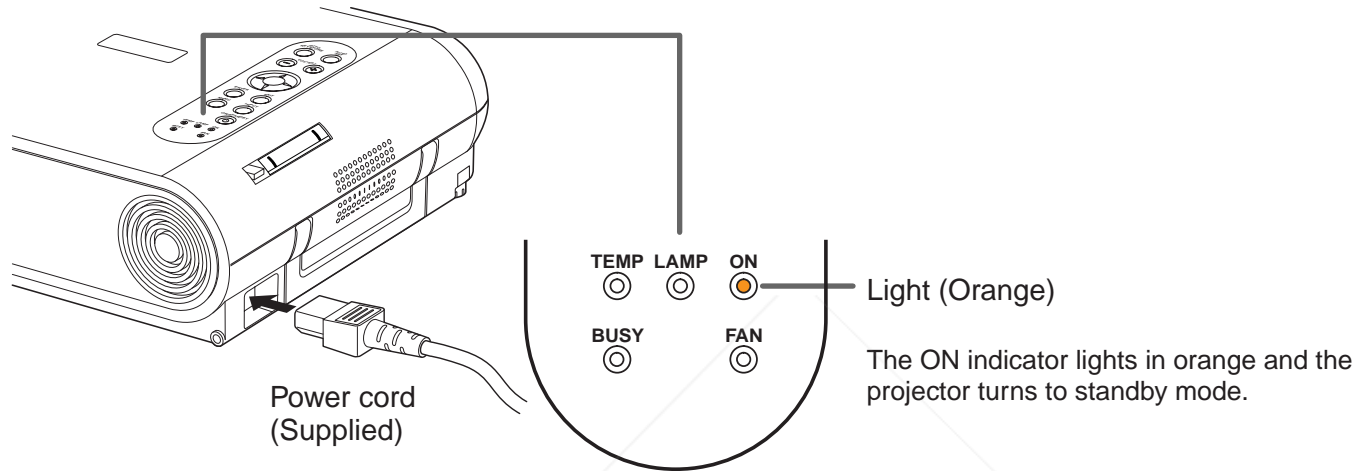

4 Take off the lens cover.

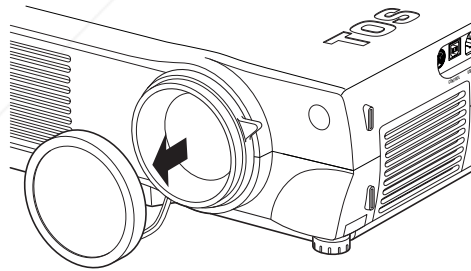

Notes

- When the projector is moved from a cold location to a warm location, or when the ambient temperature in the projection room has risen suddenly, moisture may condense on the lens or the internal optical section to blur the projected pictures. In such a case, leave the projector for an adequate time (1 to 2 hours, depending on the room's condition) before using it, so it adjusts to the ambient temperature.
- If the screen is exposed to direct sunlight or other strong light, the projected picture becomes too faint to see. Shut out the light with curtains or other means.
- If the screen and the projector are not installed properly, the projected picture may be distorted.

The tilt of the projector can be adjusted using the foot adjuster.

1

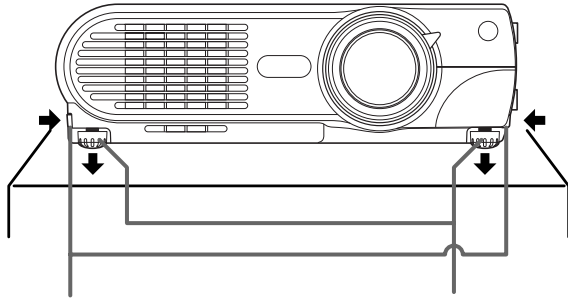

Foot adjuster release button

Foot adjuster

Lift the front of the projector until a tilt angle desired is obtained and hold down the foot adjuster release button.

The foot adjuster will stretch.
Release the button to lock in position.

2

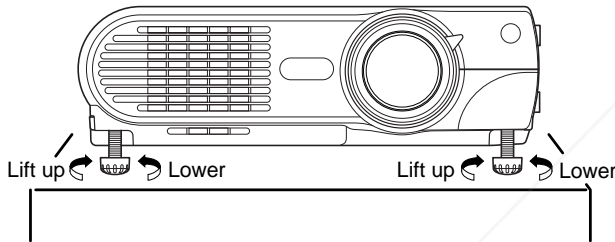

Turn the foot adjuster to make fine adjustment of the height.

Turn clockwise to lift up.
Turn counterclockwise to lower.

Notes

- To put the foot adjuster back, hold down the foot adjuster release button and lower the front slowly.
- Be sure to hold the projector when putting the foot adjuster back so as not to let the front fall on your fingers.
- Do not tilt the projector at an angle exceeding the range adjustable by the foot adjusters, since the duration life of the lamp may be shortened.

CAUTION

When a ceiling mount is required, please consult with the dealer.

Ceiling-mounted front projection

Viewing a picture projected on the front of the screen from a ceiling installation.

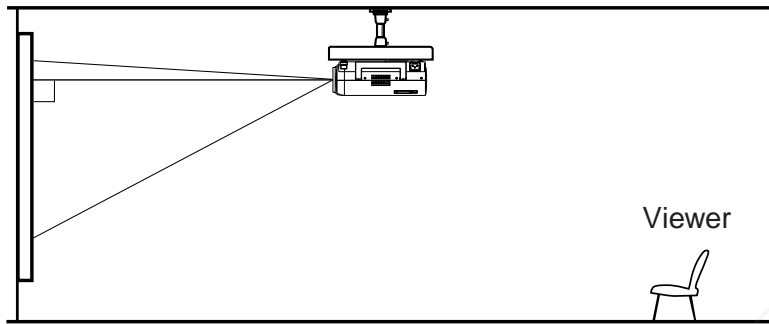

Ceiling-mounted rear projection

Viewing a picture projected through the back of the screen from a ceiling installation.

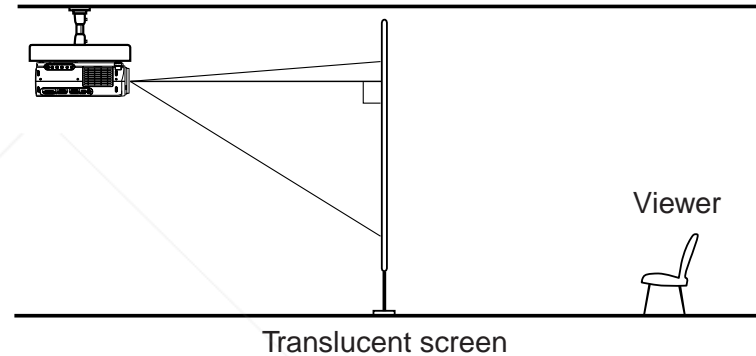

Perform the "Projection mode" setting on the menu screen for the projection method. [67](#)

Notes

- For models with a document imaging camera, the ceiling-mounting is not recommended, since the camera arm may hang down if the projector is suspended from the ceiling.
- The relation between the projection size and the distance to the screen is the same as that of the floor-mounted projection mode [18](#).

Connecting a computer

You can project the picture from the computer.

Check that the power for the projector and computer is off before connecting the cables.

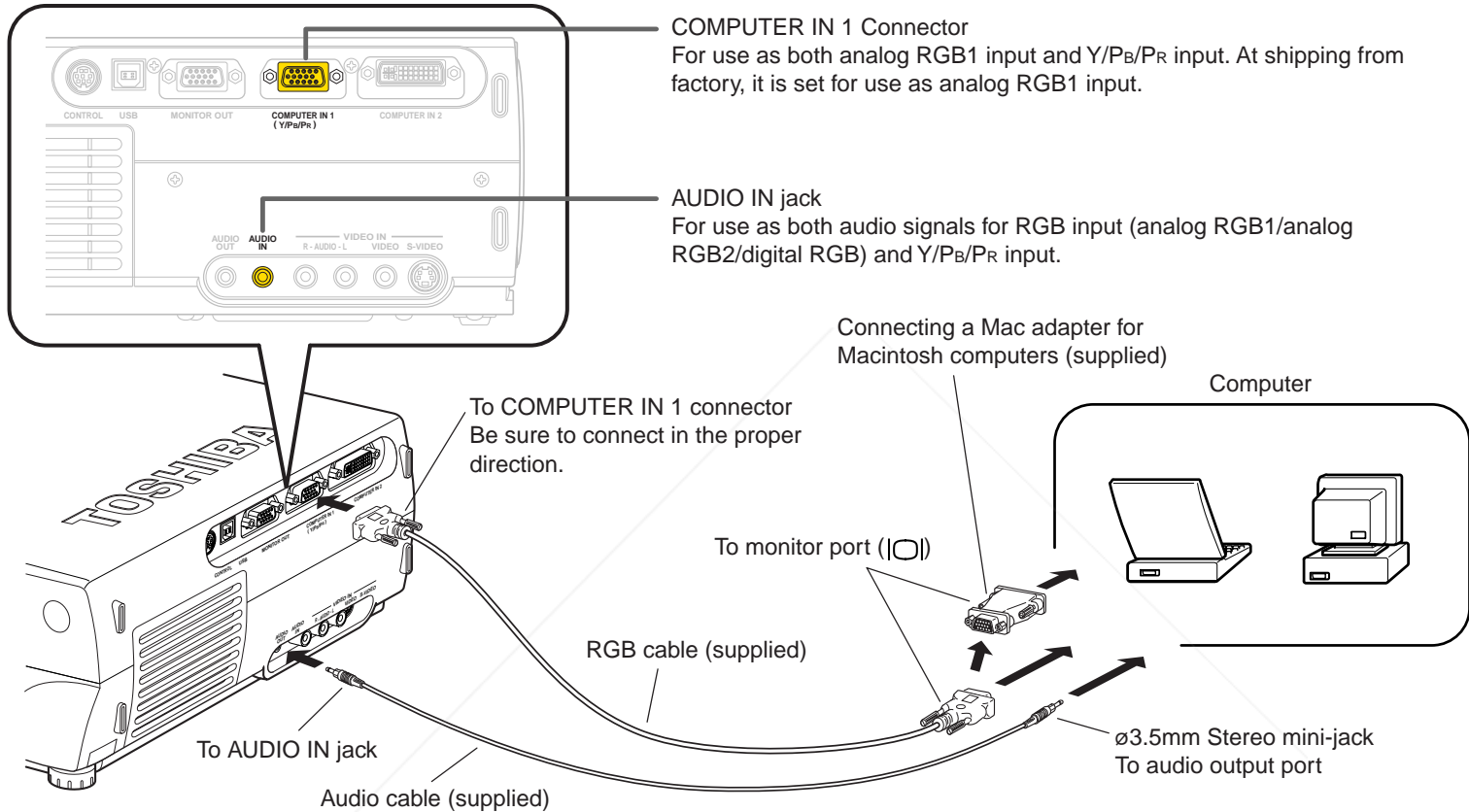

Notes

- The projector cannot be connected to a computer without an analog RGB connector. For details, refer to the computer manual.
- When connecting to a Macintosh computer, use the supplied Mac adapter (Multiple Scan 21 compatible). For some models the adapter is not required.
- You may not be able to connect some computers to the projector. For details, consult the dealer.
- Some computers may have output modes which are not compatible with this projector. Check the compatibility of the connectors, signal levels, timing, resolutions, etc.

Connecting a computer with DVI output connector

You can project the picture by entering the digital RGB signals from a computer with DVI output connector. Check that the power for the projector and computer is off before connecting the cables.

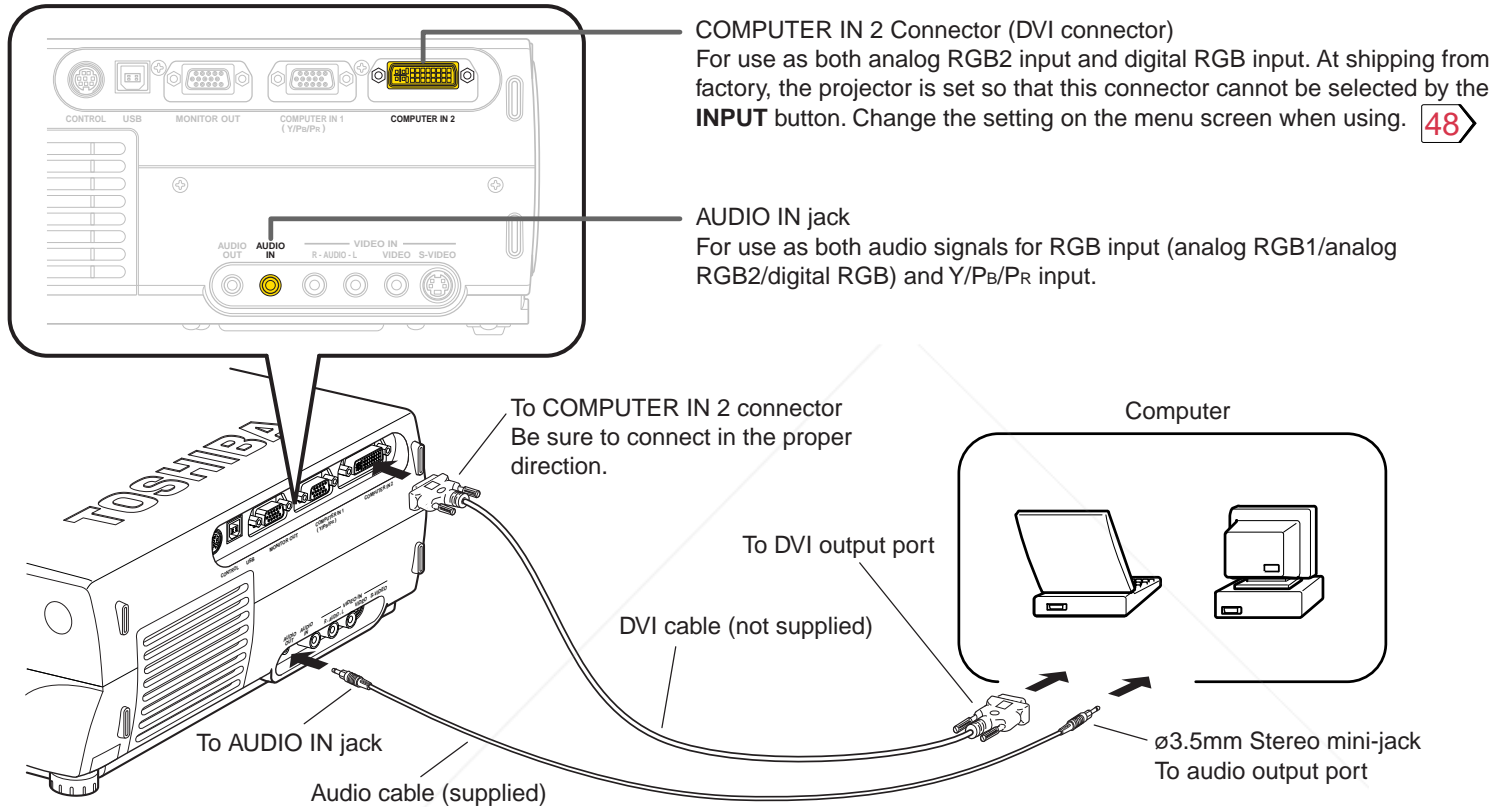

Notes

- The COMPUTER IN 2 connector can be used to input either digital RGB or analog RGB signals, depending on the connection cable used. The projector's DVI connector is of the DVI analog & digital type. Check the type of output connector on the computer, then purchase the appropriate type of connection cable. (To input analog RGB signals from a computer without a DVI connector, use a DVI cable on which the computer side connector is a mini D-sub 15-pin connector.)
- You may not be able to connect some computers to the projector. For details, consult the dealer.
- Some computers may have output modes which are not compatible with this projector. Check the compatibility of the connectors, signal timing, resolutions, etc.

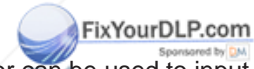

www.fixyourdlp.com

Connecting video equipment

You can project the picture from video equipment by using VIDEO IN connectors. Check that the power for the projector and video equipment is off before connecting the cables.

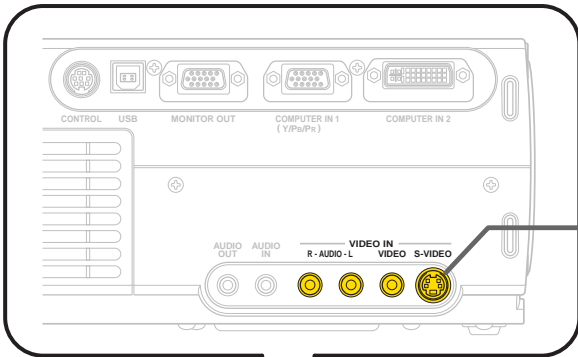

S-VIDEO connector

At shipping from factory, the projector is set so that this connector cannot be selected by the **INPUT** button.

Change the setting on the menu screen when using. **48**

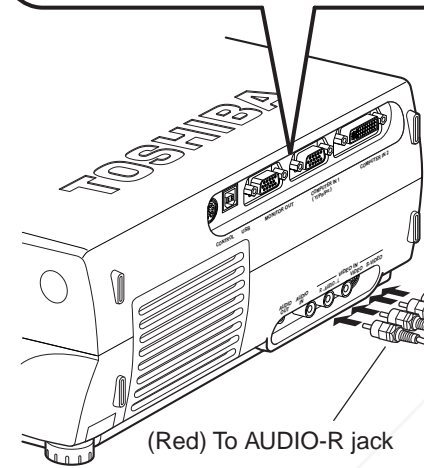

To S-VIDEO connector
Be sure to connect in the proper direction.

To S-video output

S-video cable
(not supplied)

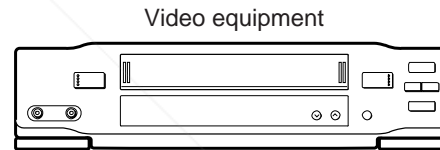

Pin plug (red)
To audio output (R)

Pin plug (white)
To audio output (L)

Pin plug (yellow)
To video output

FixYourDLP.com
Sponsor

Discount-Merchant.com (800) 281-8860

THE TRUSTED SOURCE FOR PROJECTOR LAMPS AND ACCESSORIES

Note

The S-VIDEO connector and VIDEO jack can be used independently, but the audio input jacks are used as both the S-VIDEO and VIDEO input.

Continued

Connecting video equipment (continued)

You can project the picture from video equipment with component video output jack.
Check that the power for the projector and video equipment is off before connecting the cables.

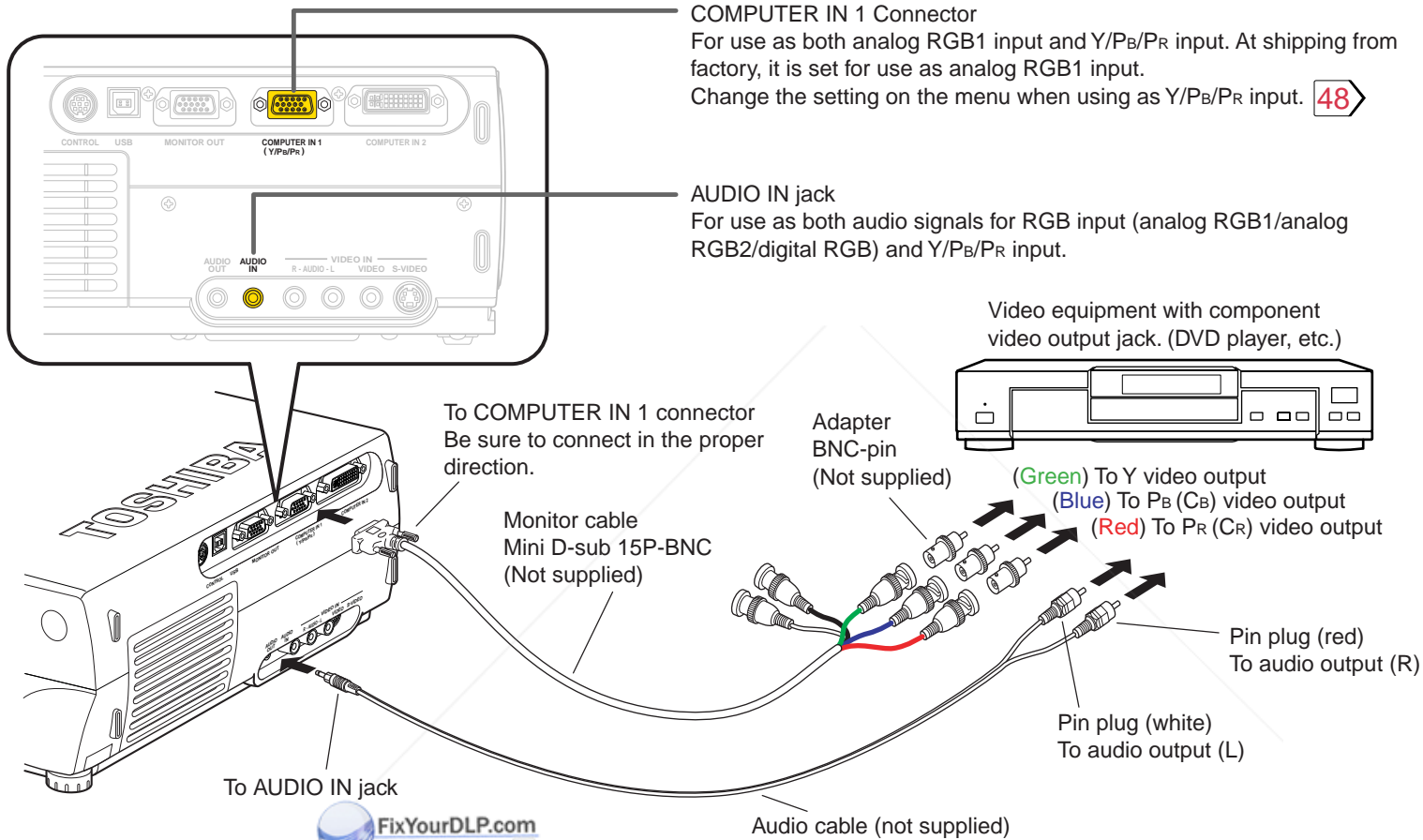

Installation and connection

Note
Some component video signal sources include the Y/C_B/C_R signals of a DVD player and the Y/P_B/P_R signals of high definition devices, etc.

Projector operation control by a computer

You can control the projector by a computer connected with the control cable supplied. **93**
Check that the power for the projector and computer is off before connecting the cables.

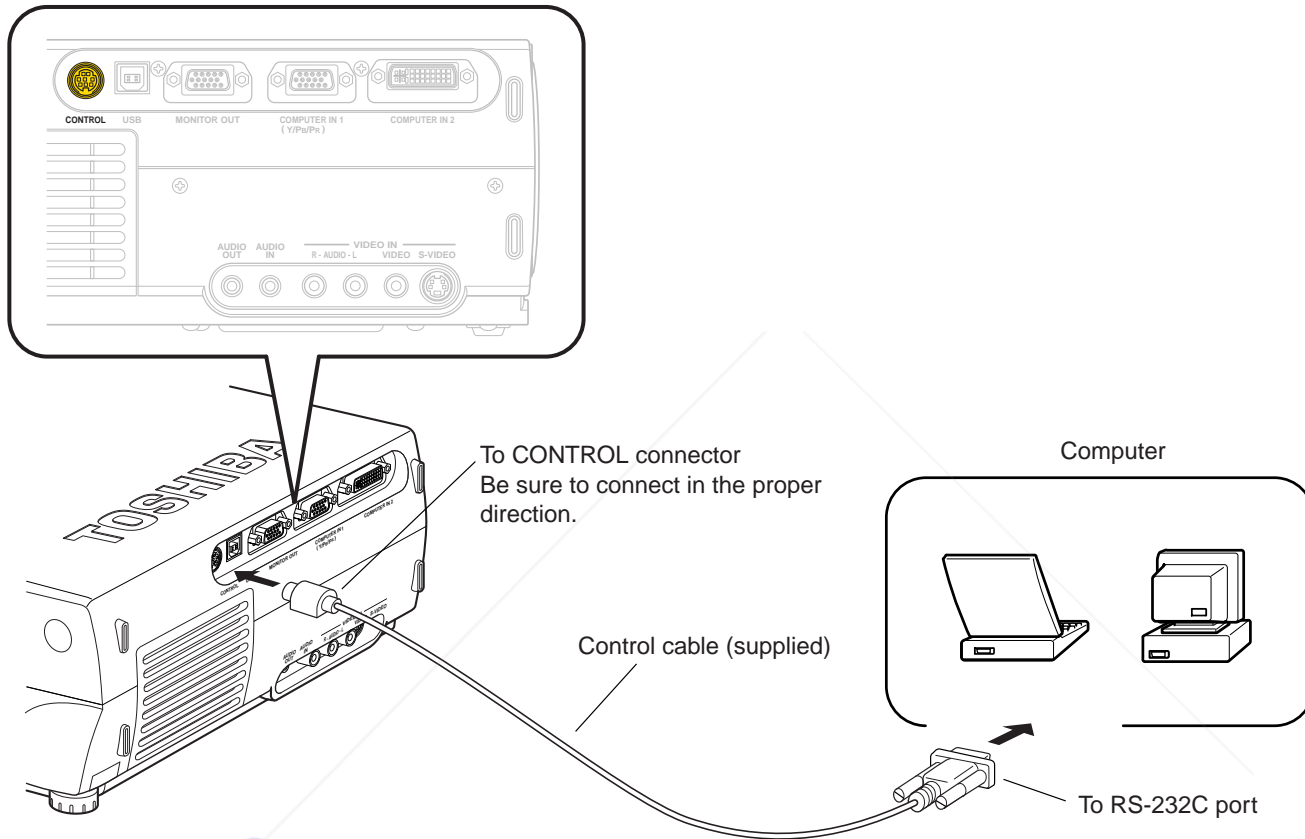

FixYourDLP.com
Sponsored by

Discount-Merchant.com (800) 281-8860

THE TRUSTED SOURCE FOR PROJECTOR LAMPS AND ACCESSORIES

Note
Do not connect a cable other than the exclusive one supplied.

How to use the output connector

You can output video and audio signals to a computer monitor, a stereo system, etc.
Check that the power for the projector and the equipments is off before connecting the cables.

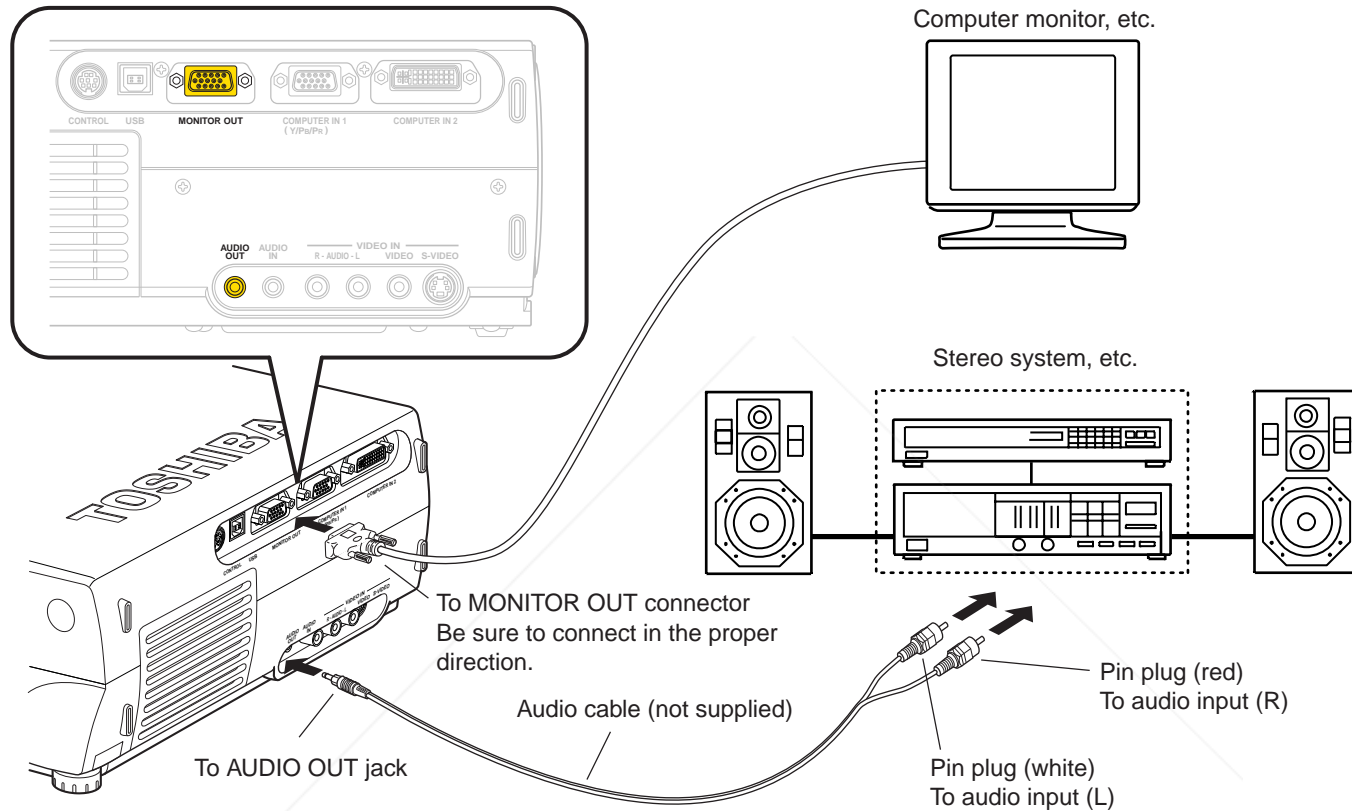

Notes

- The audio signals of the input source selected by the input select operation are output from the AUDIO OUT jack. The signal level (volume) is fixed.
- The analog RGB signals of the COMPUTER IN 1 or COMPUTER IN 2 connector selected by the input select operation are output from the MONITOR OUT connector. If neither of these input sources is selected, the analog RGB signal of the COMPUTER IN 1 connector is output. (Digital RGB signals are not output.)
- Signals are output from the MONITOR OUT connector even when in the standby mode.
- Do not turn the projector on or off with the stereo system, etc., turned on. This may damage the stereo's speakers.

CAUTION – Do not look into the projection lens while operating the projector.

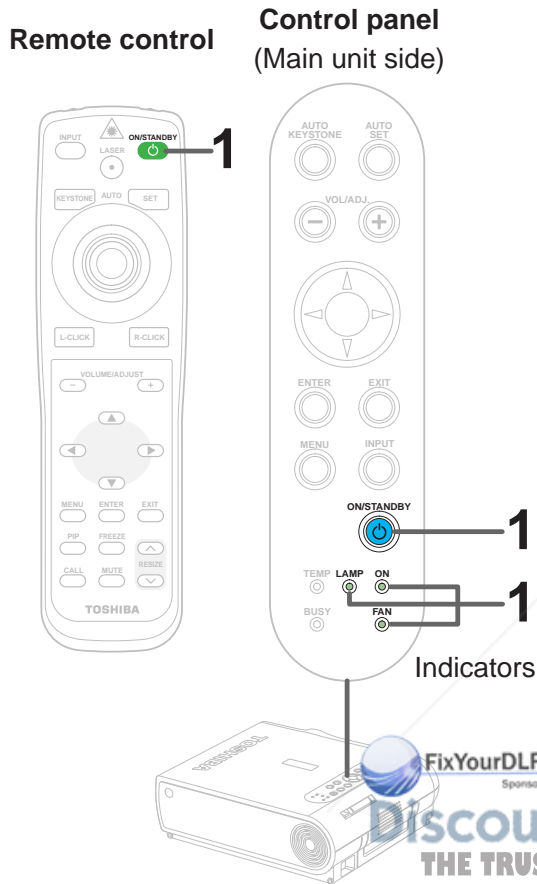

Preparation

- 1 Install and connect the projector properly.
- 2 Take off the lens cover.

1



Press ON/STANDBY.

The projector turns on and the ON, LAMP and FAN indicators light in green.

(The LAMP indicator blinks while the lamp is warming up.)

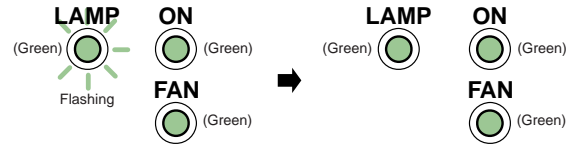

The lamp lights and the start up display appears.

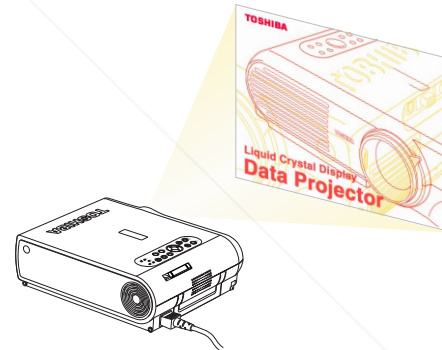

2

Turn on the connected equipment and put it in playback mode.



Select "Cancel" when the dialog box of Add New Hardware Wizard screen appears on the computer.

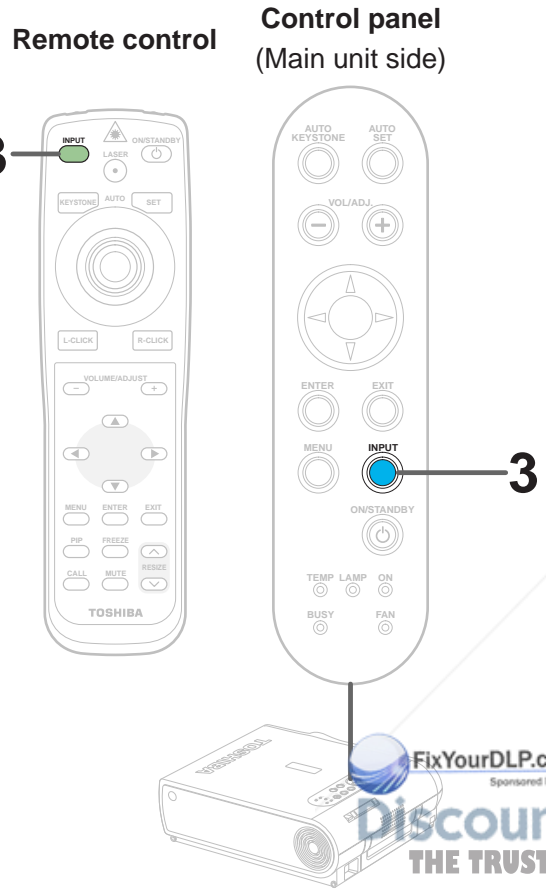

3

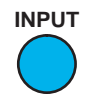

Select the input source.

Press the **INPUT** button repeatedly to select it. The icon of the input source selected appears.



(You can select "Camera" when using the model with a document imaging camera.)

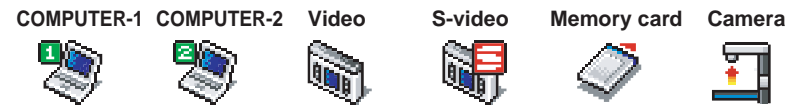

Note

The types of input sources selected when the **INPUT** button is pressed repeatedly can be set from the menu screen. [48](#)

(At shipping from factory, the projector is set so that the RGB signal source input to the COMPUTER IN 1 connector and the video signal source input to the VIDEO jack can be selected.)

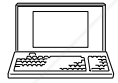

(Signal sent from the computer)

- If you project an image from a computer with an LCD screen while monitoring the image on the computer, the image may not be projected properly, depending on the computer model. In this case, turn off the computer display. For details on controlling the computer display, etc., refer to the computer's manual and description on the software for the computer used.
- The projector projects an image by XGA signal (1024 x 768) in full screen.
- The projector projects an image by VGA or SVGA signal in full screen size, the image quality may be slightly degraded. But, when you set the "Screen size" in the menu screen [54](#) to "Thru", the display size will be reduced without the image quality be degraded.
- The projector has simplified display compatibility with the signals whose picture dots are more than that of XGA signal. (However, letters and lines can be unequal or a part can be missing. Some signals may not be projected at all.)
- It is recommended to set an external monitor connected to the computer to XGA mode (1024 x 768).
- The projector can be also applied to DDC2B (Display Data Channel 2B). If your computer is applied to the DDC, start up your computer after turning on the projector.

FixYourDLP.com
Sponsored by
Discount-Monitors.com
THE TRUSTED SOURCE FOR PROJECTOR LAMPS AND ACCESSORIES
800-281-8860

Remote control

Control panel
(Main unit side)

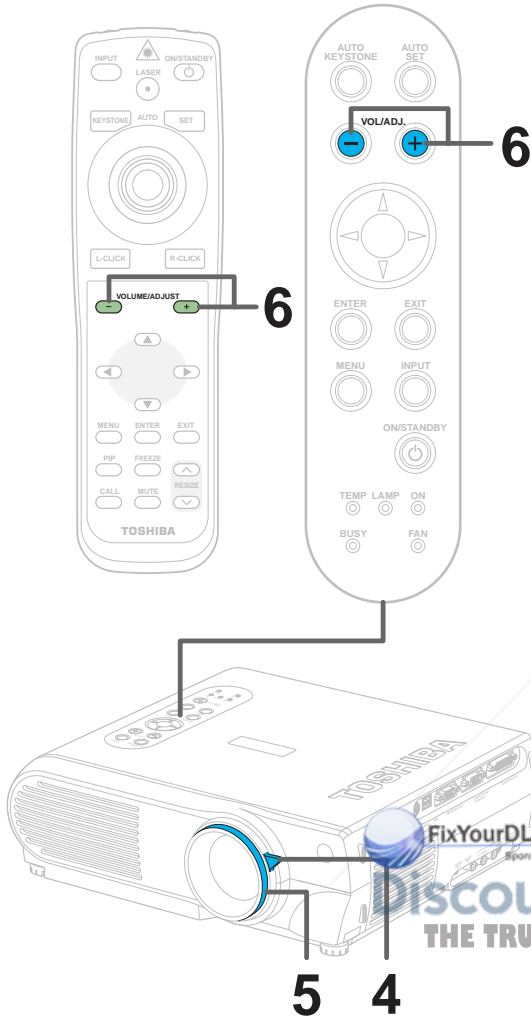

4

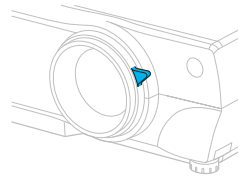

Adjust the picture size by turning the zooming lever.

Turn to the right to enlarge the picture.
Turn to the left to reduce the picture.

5

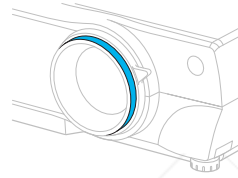

Focus on the picture by turning the focusing ring.

A still picture is recommended for focusing.

6

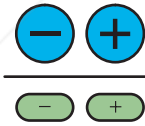



Press VOL/ADJ (+/-) to adjust volume.

Press the (+) button to increase volume.
Press the (-) button to decrease volume.
The volume adjusting bar and the icon appear.



Notes

- When changing the projecting angle, adjust the foot adjuster. **20**
- When the screen image is distorted in keystone, press the **AUTO KEYSTONE** button. **33**
- The projector may stop operating if the surrounding temperature is too high or if the air filter is clogged with dust. **82**
- Due to the lamp characteristic, flickers may occasionally occur in a picture. This is not malfunction of the unit.
- The projector's liquid crystal panel is made using extremely advanced technology, but there may be black spots (pixels that do not light) or bright spots (pixels that are constantly lit) on the panel. Please note that these are not malfunctions.
- When trying to press the button whose operation is not available, the icon  appears.
- When supplying the signal not compatible to the projector, the icon  appears.
- When signals are not input from the input source, the icon  appears.

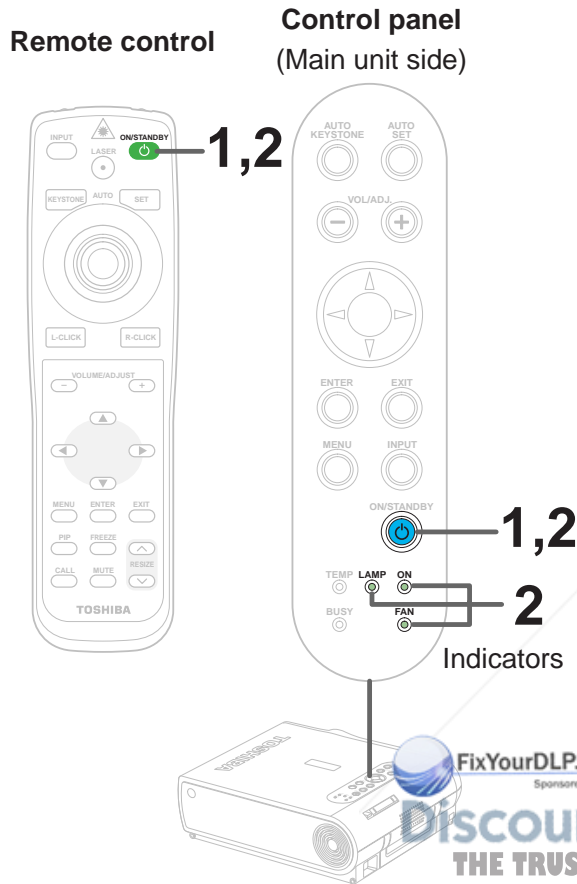

1



Press ON/STANDBY after using the projector.

An instruction message appears.



2



Press ON/STANDBY again.

Cooling starts. Once cooling is completed, the LAMP and FAN indicators turn off and the standby mode is set. (The ON indicator turns in orange.)

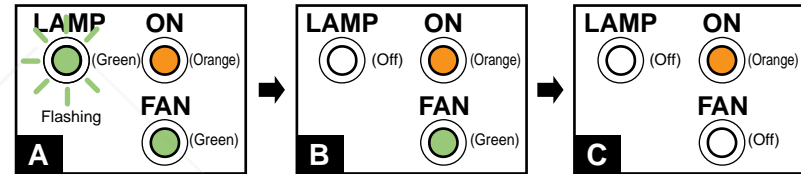

- A** To protect the light source lamp, the LAMP indicator blinks as long as a minimum of cooling is necessary. The power cannot be turned back on during this time. Unplugging the power cord at this time will shorten the lamp's duration life.
- B** The cooling fan continues to run for a while to expel the heat remaining inside. If you are in a hurry, however, you may unplug the power cord at this time.
- C** The standby mode is set.

Notes

- The projector consumes about 20W of power in the standby mode. We recommend you to unplug the power cord when not using the projector for long periods of time.
- Be sure that the LAMP indicator has turned off before unplugging the power cord. Cutting the power by unplugging the power cord while the projector is operating or the light source lamp is being cooled will shorten the lamp's duration life.

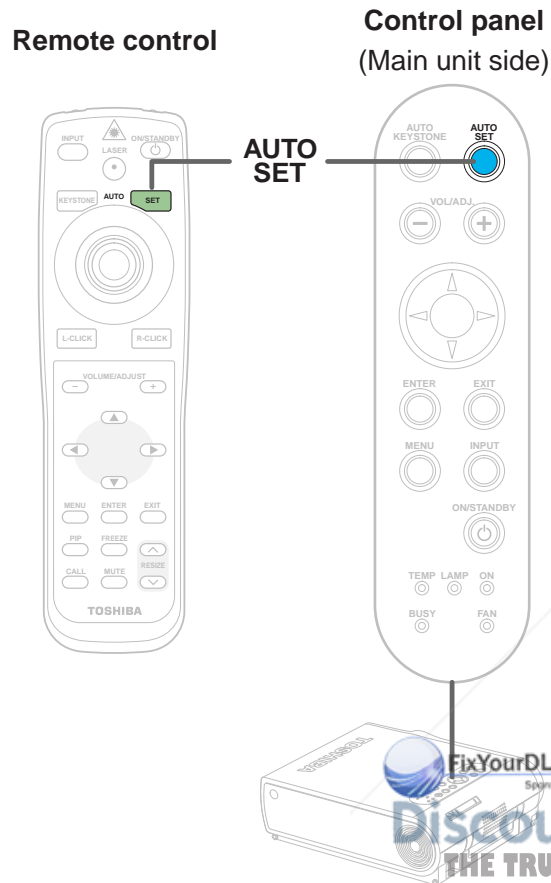

You can adjust the optimum horizontal position, vertical position, sampling phase and sampling frequency for projecting RGB signals at the touch of a button.

1

Input full screen video signals from the input source (computer) and project the image.

Adjustments may not be performed properly for images that are not displayed on the entire screen or extremely dark images.

2



Press **AUTO SET**.

The horizontal position, vertical position, sampling phase and sampling frequency are adjusted automatically.



The icon  appears during signal processing.

Notes

- Automatic adjustment may not be performed properly for signals other than the RGB signals with which the projector is compatible [91](#).
- The horizontal position, vertical position, sampling phase and sampling frequency can also be adjusted from the menu screen [54](#).

* Sampling frequency

Analog RGB signals input from the computer are converted into digital signals inside the projector. The sampling frequency is the number of times per second the analog signals are converted into digital signals. In order to capture (sample) each individual dot of the computer's signals, the sampling frequency must be adjusted to match the computer's dot clock frequency. If this adjustment is off, details of the image may be blurred, a striped pattern may appear when images with many vertical lines are displayed, or the image's width may change. For RGB signals with which the projector is compatible, the sampling frequency is adjusted automatically even without pressing the **AUTO SET** button.

• Sampling phase

The sampling phase is the timing at which the computer's analog RGB signals are sampled. If the sampling phase is off, the individual dots cannot be sampled at the proper timing, resulting in blurred or flickering images.

Remote control

Control panel
(Main unit side)



AUTO KEYSTONE

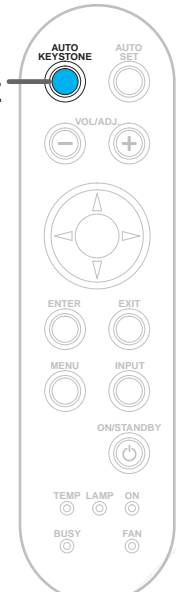

A picture may be expanded on the upper side if projected upward from the projector lifted up by the foot adjuster. The projector can correct this keystone distortion automatically.

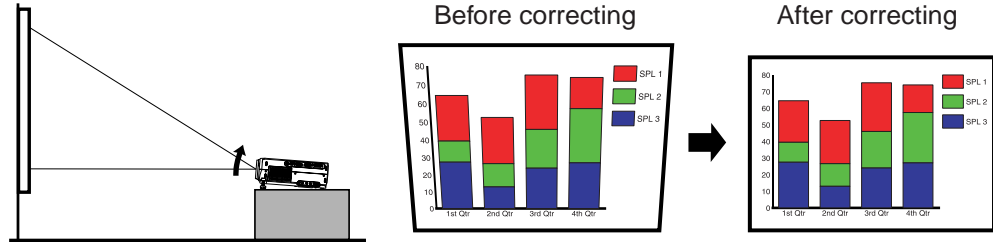

AUTO KEYSTONE



Press AUTO KEYSTONE.

The keystone distortion on the picture projected is automatically corrected.

KEYSTONE



The icon appears while the keystone correction is executing.

To correct further, make the "Keystone" adjustment on the menu. **48** **62**

Notes

- Due to digital correction processing, some of the information may be dropped or the picture quality may be degraded depending on the keystone correction setting or the contents of the signal source.
- Keystone distortion is not corrected properly when the screen is not installed vertically. In this case, adjust from the menu screen.

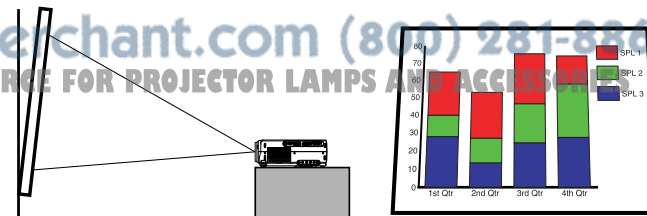

Even if the projector is set horizontal, keystone distortion may occur if the screen is at an angle. In this case automatic correction is impossible.

Remote control



MUTE

The image and sound of this projector can be turned off if you wish to temporarily project the image of another projector or a OHP, etc., on the screen.



Press MUTE.

The sound and picture are cut off temporarily.

To cancel the mute mode, press **MUTE** again. The image and sound will be output.

The icon  appears in the mute mode.

Note

The mute mode is cancelled if another operation is performed during the mute mode.

Remote control



You can freeze the image being projected.

Use this function to stop images from a video recorder to make presentations.



Press **FREEZE**.

The picture freezes.

To release the picture, press **FREEZE** again.

The icon  appears in the freeze mode.

Notes

- The freeze mode is cancelled if any other operation is performed during the freeze mode.
- You can not use the **FREEZE** button when the memory card input is selected.
- The freeze mode cannot be set when there is no input (when no signals are being supplied from a signal source).
- The input source's image continues to play even when the projector is set to the freeze mode.

Remote control

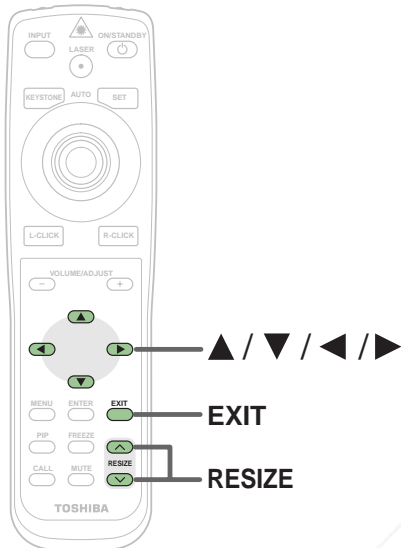

You can enlarge (resize) the picture size projected.



Press RESIZE (^).

The enlargement ratio increases each time the RESIZE (^) button is pressed.

The enlargement ratio can be increased continuously by keeping the button pressed in.



To reduce the enlargement ratio, press the RESIZE (v).

The enlargement ratio can be reduced continuously by keeping the button pressed in.

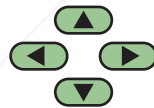

The enlarged section is moved when the selection buttons (▲/▼/◀/▶) are pressed.

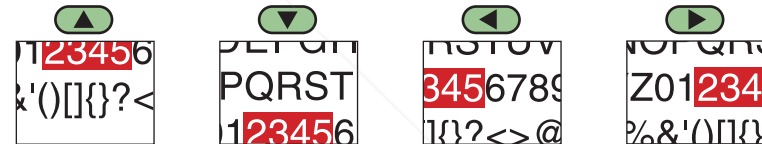

The section can be moved continuously by keeping the button pressed in.



Press the EXIT button to cancel the resize mode and return to the original size.

Notes

- Enlarged images can be frozen by pressing the FREEZE button. When frozen, images cannot be enlarged or reduced.
- The resize mode is cancelled if any operation other than setting the freeze mode is performed.
- This projector uses electrical digital resizing, so the picture quality degrades when images are enlarged.
- In rare cases, the picture may be disturbed while the magnification section is being moved.
- With some signals, the image cannot be enlarged.
- This function does not work in no input status (no signal is supplied from the signal source).

The icon  appears in the  mode DLP.com

Discount-Monitors.com (800) 281-8860
THE TRUSTED SOURCE FOR ALL YOUR ELECTRICAL AND VIDEO SOLUTIONS

Remote control

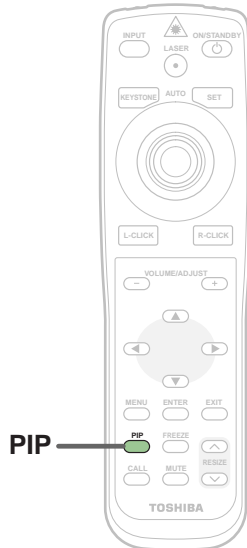

Video or S-video images can be displayed as small images on the computer's image. (Referred to as "sub-pictures" in this manual.)



Press PIP.

A sub-picture is displayed.

Press the **PIP** button again to turn off the sub-picture.

Notes

- The PIP function cannot be used when a source other than an RGB input source is selected.
- The PIP function cannot be used with no signals supplied from an RGB signal source.
- The sub-picture turns off if any other operation is performed.
- The signal source, size, display position and audio input source to display sub-pictures can be changed from the menu screen. **73**

Remote control



CALL

Information on the input signal source, etc., can be displayed.



Press CALL.

The information described below is displayed.

The information display turns off when the **CALL** button is pressed again.



Status display

- Input – current input source
- H-resolution – the horizontal resolution of the input signal (at RGB input)
- V-resolution – the vertical resolution of the input signal (at RGB input)
- H-frequency – the horizontal frequency of the input signal (at RGB input)
- V-frequency – the vertical frequency of the input signal (at RGB input)
- Video mode – the color mode of the video signal (at video, S-video input)
- Signal format – the formatting of the component signal (at Y/PB/PR input)
- Card type – the type of the memory card (at memory card input)
- Lamp time – the elapsed using time of the lamp
- Version – the version of the firmware
- Shutter – the shutter speed of the document imaging camera (at document imaging camera input)

Notes

- The information displayed is not refreshed even if it changes. To refresh the information, turn off the information display, then turn it back on.
- The information display turns off if any other operation is performed.
- The “Lamp time” shows an approximate time for lamp replacement. (It should not be used as a lamp warranty time counter.) If the time indicated here nears 1000, contact your store of purchase about obtaining a replacement lamp (TLPLX10, sold separately). The fractions of the actual usage time are discarded from the time indicated here each time the projector is used, so the indicated time is actually somewhat shorter than the actual usage time.
- The “Lamp time” can be reset when the lamp is replaced.
- The “Version” is the version of the control program used in the projector and is used for servicing, etc.

Operating a computer by the remote control

You can control a computer by the remote control when the projector and computer are connected with the supplied USB cable. In this manual, this function is explained as “mouse remote control”.

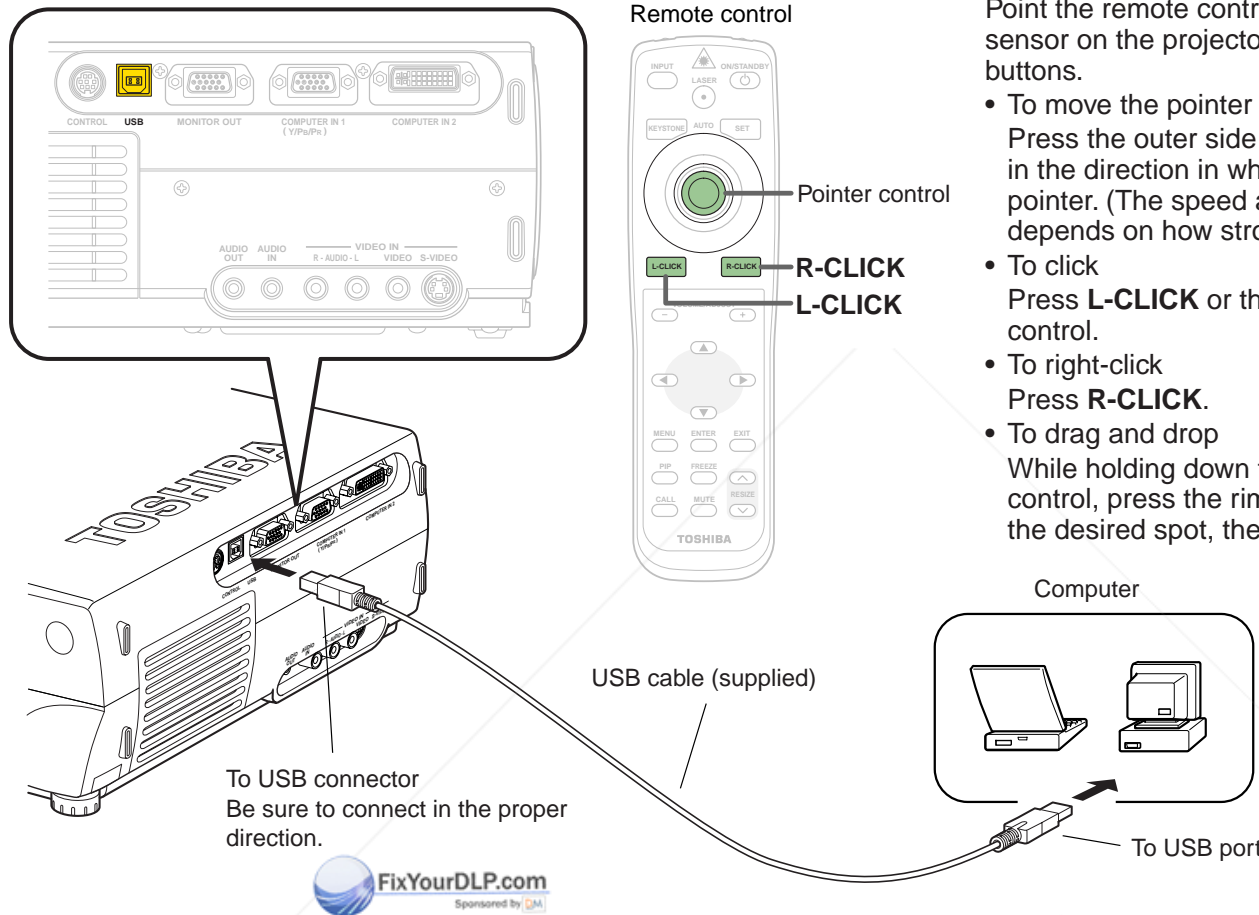

Point the remote control at the remote control sensor on the projector when operating with its buttons.

- To move the pointer
Press the outer side of the pointer control button in the direction in which you want to move the pointer. (The speed at which the pointer moves depends on how strongly the button is pressed.)
- To click
Press **L-CLICK** or the center of the pointer control.
- To right-click
Press **R-CLICK**.
- To drag and drop
While holding down the center of the pointer control, press the rim side to move the pointer to the desired spot, then release the center part.

Notes

- This function is available with Windows98 and Mac OS9 computers equipped with a USB port as standard.
- When connecting the computer's USB port for the first time, a message asking you to insert the Windows98 CD-ROM may appear on the computer's monitor screen, depending on whether or not the device driver is installed. If so, do as the message says.
- When using a USB cable other than the supplied one, be sure to use a shielded type.

This projector can read the image data of JPEG format stored in a memory card to project the images on the screen.

For example, you can perform the presentation without a computer by converting the presentation data prepared on the computer into JPEG format and then saving in the memory card. (It cannot reproduce the motion in the same manner of the Microsoft PowerPoint animated effect.)

Read this page carefully before using this function.

About memory cards

- The card slot on the projector conforms with PC Card Standard TYPE II. Use a memory card and converter adapter (PC card adapter) compatible to this type of card slot.
- The following ATA-compatible recording media (on the market) is available. In this manual all such cards are explained in general as "memory card".
 - Flash ATA card
 - SmartMedia™ card (used with a SmartMedia™ PC card adapter)
 - CompactFlash card (used with a CompactFlash PC card adapter)
 - Memory Stick (used with a Memory Stick PC card adapter)
 - Multimedia card (used with a Multimedia PC card adapter)
 - SD Memory card (used with an SD Memory card PC card adapter)
 - TOSHIBA mobile HDD MEHDD20A

Note that inserting other memory cards, adapters or PC cards with different functions into the projector may damage the card or cause malfunction.

- Memory cards confirmed to operate properly on the projector
Toshiba does not guarantee the whole operation.
 - Flash ATA card: I-O DATA PCFCA-96M (96MB), PCFCA-128M (128MB)
 - SmartMedia card: TOSHIBA PDR-SM16 (16MB), PDR-SM32 (32MB), PDR-SM64 (64MB)
Adapter: FUJIFILM PC-AD3B, OLYMPUS MA-2
 - CompactFlash card: SanDisk SDCFB-64-505 (64MB), SDCFB-128-505 (128MB)
Adapter: SanDisk SDCF
 - Memory Stick: SONY MSA-32 (32MB)
Adapter: SONY MSAC-PC2N
 - Multimedia card: I-O DATA PCMMC-32MS (32MB)
Adapter: I-O DATA PCMMC-ADP
 - SD Memory card: Panasonic RP-SD032 (32MB)
Adapter: Panasonic BN-SDAAP3

- * The Toshiba IPC5019A, BUFFLO RFD-A2 SmartMedia PC card interface adapter cannot be used.
- For security, we recommend you to back up the data stored in the memory cards before use. (Note that Toshiba will take no responsibility for damages, loss of profits, etc., due to lost data or other problems causing from the use of the projector.)

About JPEG files

- 1) Folder names must have no more than 11 characters, file names no more than 8 characters.
- 2) Only compatible with files with the following extensions: .jpg, .JPG, .jpeg, .JPEG
- 3) The total number of Sub-folders and files in a folder should be within 512.
- 4) Depending on the JPEG compression format, it may take time to display images.
- 5) Depending on the JPEG compression format, some images may not be used on the projector.
- 6) The maximum available file size is 1 MB.
- 7) The maximum available image size is 1280 x 1024 dots.

- * If you record the JPEG file into the memory card after converting the JPEG files with the exclusive utility software (contained in the supplied CD-ROM), the processing time of the 4) above can be shortened. Moreover, the restrictions above-mentioned in the 5) to 7) can be eased.



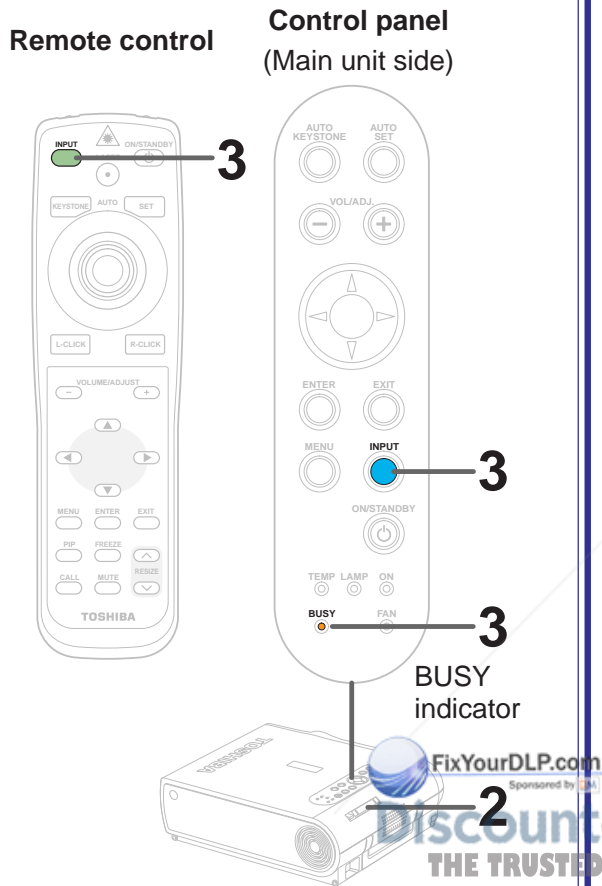

1 When using the memory card function for the first time, set the “Input source setting” on the menu screen.

With the factory default setting, it is impossible to select the memory card input by the **INPUT** button. Change the setting following the instructions of “QUICK MENU Adjustments and Settings” 48 to make the memory card input selectable.

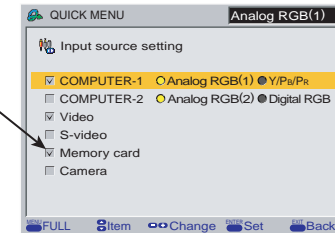

Check “Memory card”.

2

Insert the memory card into the card slot.

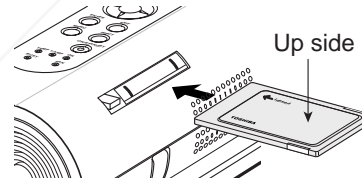

Insert the card securely, pressing it as far as it can go.

Be careful to insert the card in the proper direction. The slot is designed so that it is difficult to insert cards in the wrong direction. Inserting the card forcibly may deform the internal terminals or cause other problems.

3

INPUT



INPUT



BUSY



(Light in orange)

Press **INPUT** repeatedly to select the memory card input.

The “Memory card” input display  appears on the screen.

- Start to read the data on the memory card and display the image data sequentially as thumbnails.
- The BUSY indicator lights in orange while the memory card is being accessed. (Do not eject the memory card while the BUSY indicator is lit.)

Continued

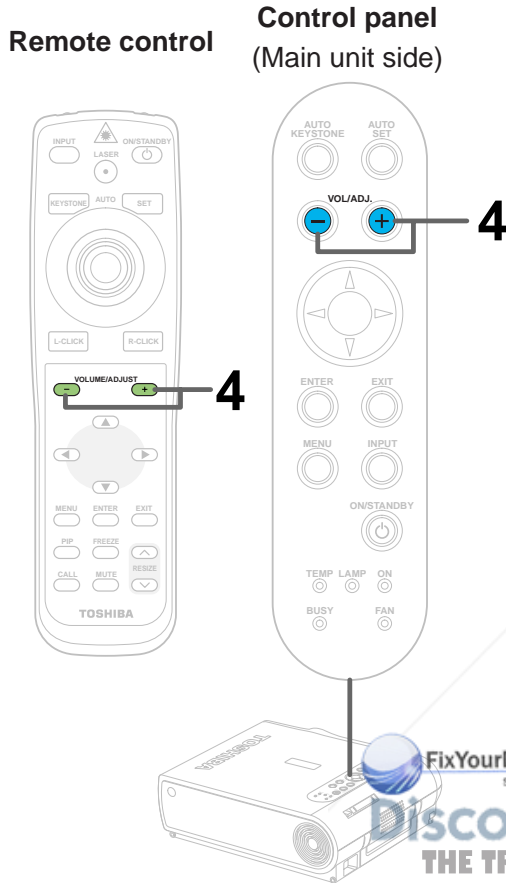

The icon  appears during image data processing.

3 (Continued)

Description of screen

The illustration below is an example for explanation purpose only. The actual display, the number of directory, etc., differs depending on the data stored in the memory card.

Display when there has a previous page.

Operation guide

Display the name of folder or file selected.

Display when there has a following page.





- When the memory card is inserted, its root directory (the topmost level) is displayed first.
-  indicates folders. There may be other folders or files inside folders. (Multiple directory)
- Small images are called thumbnails. JPEG files are displayed as thumbnails.
- The numbers in the circles are not displayed.

- ①, ②: Folders containing JPEG files
- ③: Folders which may contain JPEG files in lower directory
- ④: Folders not containing JPEG files
- ⑤: Folders with camera images stored. (For the models with document imaging camera)
- ⑥ to ⑱: JPEG files stored in the currently displayed directory
- ⑲: JPEG files that cannot be displayed as thumbnails
- ⑳: Files not compatible
- ⑥: The orange frame indicates the currently selected JPEG file

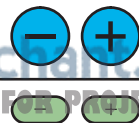
4



Use VOL/ADJ (+/-) to change pages. (Page changing)

When an icon  or  is displayed to indicate that there is a previous or following page, use the VOL/ADJ (+/-) buttons to change pages and search for the desired thumbnails or folders.

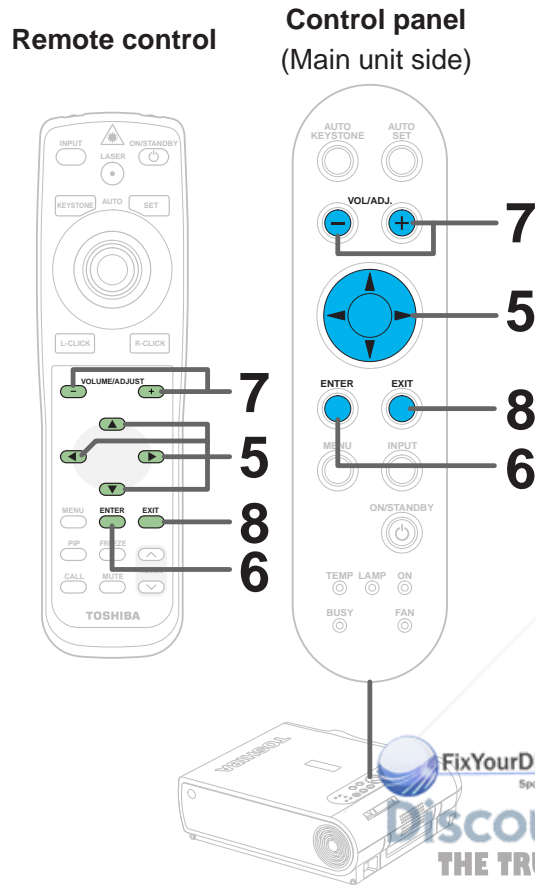

5



Use the selection buttons (▲ / ▼ / ◀ / ▶) to select the thumbnail you wish to display as a slide. (Thumbnail selection)

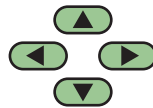

- The selected thumbnail is surrounded by an orange frame.
- If the desired file (thumbnail) is in a different folder, select that folder.

6

ENTER



Press ENTER. (Slide display)

- When a thumbnail is selected, that image is displayed as a slide (a large picture).
 - When a folder is selected, the contents of that folder are displayed as thumbnails in the same way as in step 3 above. In this case, return to step 5 or 4.
- When a folder is selected, repeat steps 5 and 6 until the desired thumbnail is displayed. The maximum number of folder directory levels that can be searched through at this time is within 5 levels from the root directory (up to 5 levels of folders).

7

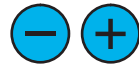

Press VOL/ADJ (+/-). (Slide transition)

- Press the (+) button to display the next slide.
 - Press the (-) button to display the previous slide.
- You can only change the JPEG files stored in the same directory level (including the previous and following pages) by the VOL/ADJ (+/-) buttons.

8

EXIT



Press EXIT.

The display returns to as it was in step 3. If you have searched to the bottommost level in step 5, pressing the EXIT button repeatedly moves the display sequentially back up to higher levels until the contents of the root directory are displayed.

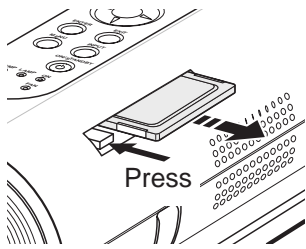

To eject the memory card

To eject a memory card, first check that the BUSY indicator is off, then press the card slot's eject button. The memory card pops out part way, then pull it out by hand.

Notes

- In the memory card input mode, you can perform the operations described below using the menu screen settings.
 - Automatic input selection function
When "Input select mode" [54](#) is set to "Auto.", the mode automatically switches to the memory card input mode when a memory card is inserted.
 - Auto slide show 1
When "Auto. demo" [48](#) is set to "On" and a memory card is loaded, a slide show of the JPEG files in the root directory starts automatically when the memory card input mode is selected.
 - Auto slide show 2
When "Slide show" [54](#) is set to "Auto.", a slide show starts automatically at the place where the leading thumbnail appointed in the step 6.
 - Auto slide show 3
When "Input select mode" is set to "Auto.", "Auto. demo" is set to "On" and memory card is loaded, a slide show of the JPEG files in the root directory starts automatically when the power is turned on. When "Power on" [67](#) is set to "Auto.", the slide show starts when the power cord is plugged into an outlet.
- With the factory default settings, the followings are set for manual operation.

| | |
|-----------------------|--------|
| Input selection mode: | Manual |
| Auto. demo: | Off |
| Slide show: | Manual |
| Power on: | Manual |
- You can select the interval time of automatic slide show transition among four types on the menu screen. [48](#) Depending on the compression format of the JPEG files, however, it may take more than the set time to transit images.
- Depending on the compression format of the JPEG files and the file sizes, it may take a time for page changing or slide transition.
- The sort order (thumbnail displaying order = slide show order) of JPEG files is in character number order. When the number of characters is the same, the sort order is arranged by the numerical characters used in each file name at first and then the alphabetical characters.

Press the **EXIT** button to stop the automatic slide show.

* In this manual, "Slide show" means the operation by which slides (large images) are displayed in sequence.



Adjustments and settings on the menu screen

- The menu screens for making various adjustments and settings include a QUICK MENU for frequently used adjustments and settings and a FULL MENU for all the adjustments and settings. The FULL MENU is divided into six sections by function: "Picture", "Audio", "Keystone", "Display", "Default setting" and "Factory reset mode".
- The items in the "Picture" and "Audio" sections of the QUICK MENU and FULL MENU differ depending on the input source.
- Some of the adjustments and settings are stored separately for different input sources, others are applied to all input sources when they are set for one. For details, refer to the pages on which the individual adjustment and setting instructions are located.

| | Analog RGB 1 Analog RGB 2 | Digital RGB | Y/Pb/Pr | Video S-video | Memory card | Document imaging camera (With camera model) |
|---------------------------|----------------------------------|----------------------------------|----------------------------------|----------------------------------|----------------------------------|------------------------------------------------|
| QUICK MENU | Contrast | Contrast | Contrast | Contrast | Contrast | Contrast |
| | Brightness | Brightness | Brightness | Brightness | Brightness | Brightness |
| | Phase | Picture mode | Color | Color | Auto. demo | Shutter |
| | Picture mode | Keystone | Keystone | Keystone | Interval | Keystone |
| | Keystone | Lamp power | Lamp power | Lamp power | Keystone | Lamp power |
| | Lamp power | Input source setting | Input source setting | Input source setting | Lamp power | Input source setting |
| | Input source setting | Language | Language | Language | Input source setting | Language |
| | Language | | | | Language | |
| FULL MENU | Picture | Picture | Picture | Picture | Picture | Picture |
| | Contrast | Contrast | Contrast | Contrast | Contrast | Contrast |
| | Brightness | Brightness | Brightness | Brightness | Brightness | Brightness |
| | Phase | Position | Color | Color | Input select mode | Sharpness |
| | Frequency | Picture mode | Tint | Tint | Auto. demo | Shutter |
| | Position | Screen size | Sharpness | Sharpness | Slide show | Screen size |
| | Picture mode | Level | Signal format | Video mode | Interval | Level |
| | Screen size | | Screen size | Screen size | Screen size | |
| | Level | | Level | Level | Level | |
| | Audio | Audio | Audio | Audio | Audio | Audio |
| | Speaker output | Speaker output | Speaker output | Speaker output | There is no audio signal | There is no audio signal |
| | Channel select (Mini) | Channel select (Mini) | Channel select (Mini) | Channel select (RCA) | in this input. | in this input. |
| | Loudness (Mini) | Loudness (Mini) | Loudness (Mini) | Loudness (RCA) | | |
| | Keystone | Keystone | Keystone | Keystone | Keystone | Keystone |
| | Keystone | Keystone | Keystone | Keystone | Keystone | Keystone |
| | Horizontal reference value reset | Horizontal reference value reset | Horizontal reference value reset | Horizontal reference value reset | Horizontal reference value reset | Horizontal reference value reset |
| | Display | Display | Display | Display | Display | Display |
| | Language | Language | Language | Language | Language | Language |
| | No signal background | No signal background | No signal background | No signal background | No signal background | No signal background |
| | Icon | Icon | Icon | Icon | Icon | Icon |
| | Menu position | Menu position | Menu position | Menu position | Menu position | Menu position |
| | Menu background translucent | Menu background translucent | Menu background translucent | Menu background translucent | Menu background translucent | Menu background translucent |
| | Start-up screen | Start-up screen | Start-up screen | Start-up screen | Start-up screen | Start-up screen |
| | Default setting | Default setting | Default setting | Default setting | Default setting | Default setting |
| Input source setting | Input source setting | Input source setting | Input source setting | Input source setting | Input source setting | |
| Lamp power | Lamp power | Lamp power | Lamp power | Lamp power | Lamp power | |
| Projection mode | Projection mode | Projection mode | Projection mode | Projection mode | Projection mode | |
| No signal power off | No signal power off | No signal power off | No signal power off | No signal power off | No signal power off | |
| Power on | Power on | Power on | Power on | Power on | Power on | |
| Factory reset mode | Factory reset mode | Factory reset mode | Factory reset mode | Factory reset mode | Factory reset mode | |
| Picture only | Picture only | Picture only | Picture only | Picture only | Picture only | |
| All | All | All | All | All | All | |

QUICK MENU

48

| Item | Meaning |
|----------------------|-------------------------------------------------------------------------|
| Contrast | Adjust the image contrast |
| Brightness | Adjust the image brightness (paying attention to the dark parts) |
| Color | Adjust the image color (except for RGB inputs) |
| Phase | Adjust the image flicker (analog RGB) |
| Picture mode | Set brightness priority or picture quality (color) priority (RGB) |
| Auto. demo | Set the automatic slide show function on and off (memory card) |
| Interval | Set the interval time to transit the automatic slide show (memory card) |
| Shutter | Set the shutter speed (document imaging camera) |
| Keystone | Adjust keystone distortion |
| Lamp power | Set the lamp power (cooling sound selection) |
| Input source setting | Set the input mode selected by the INPUT button |
| Language | Set the display language used for menus and messages |

FULL MENU

54

| Picture | |
|-------------------|-----------------------------------------------------------------------------------|
| Item | Meaning |
| Contrast | Adjust the image contrast |
| Brightness | Adjust the image brightness |
| Color | Adjust the image color |
| Tint | Adjust the image tint |
| Sharpness | Adjust the image sharpness |
| Phase | Adjust the image flicker (dot clock timing adjustment) |
| Frequency | Adjust the vertical stripes with detailed images (dot clock frequency adjustment) |
| Position | Adjust the horizontal and vertical positions of the image |
| Level | Adjust the red, green and blue level (balance) |
| Picture mode | Set brightness priority or picture quality (color) priority |
| Video mode | Set the video or S-video color system |
| Signal format | Set the Y/Pb/Pr signal DTV format |
| Screen size | Set whether to convert to XGA size or display with the input resolution |
| Input select mode | Set the input selection Auto./Manual at memory card detection |
| Auto. demo | Set the automatic slide show function on and off (memory card detection) |
| Slide show | Set slide show advancing Auto./Manual |
| Interval | Set the interval time to transit the automatic slide show |
| Shutter | Set the shutter speed according to the power supply frequency |

Audio

60

(Adjust the audio output from the speaker on the main unit)

| Item | Meaning |
|-----------------------|---------------------------------------------------------|
| Speaker output | Set the speaker output On/Off |
| Channel select (RCA) | Select the channel of AUDIO (L/R) jack in VIDEO IN |
| Loudness (RCA) | Set the loudness of AUDIO (L/R) jack On/Off in VIDEO IN |
| Channel select (Mini) | Select the channel of AUDIO IN jack |
| Loudness (Mini) | Set the loudness of the AUDIO IN jack On/Off |

Keystone

62

| Item | Meaning |
|----------------------------------|-------------------------------------------------------------------|
| Keystone | Adjust the Keystone distortion |
| Horizontal reference value reset | Reset the horizontal reference value for the automatic adjustment |

Display

64

| Item | Meaning |
|-----------------------------|------------------------------------------------------|
| Language | Set the display language used for menus and messages |
| No signal background | Set the background at no signal input |
| Icon | Set the icon display On/Off |
| Menu position | Set the position of the menu screen |
| Menu background translucent | Set the menu background translucent On/Off |
| Start-up screen | Set the start-up screen at power on |

Default setting

67

| Item | Meaning |
|----------------------|-----------------------------------------------------------------------------|
| Input source setting | Set the input mode selected by the INPUT button |
| Projection mode | Set the direction of the screen according to the projection mode |
| No signal power off | Set the automatic power off function On/Off when no signal status continues |
| Power on | Set the power on On/Off when plugging the power cord |
| Lamp power | Set the lamp power (cooling sound selection) |

Factory reset mode

71

| Item | Meaning |
|--------------|--------------------------------------------------------------------------------------------|
| Picture only | Return the items of the picture menu to the factory default setting for each input source. |
| All | Return all of the items to the factory default setting for all input sources. |

Note

An exclusive menu is displayed when making PIP function sub-picture settings. 73

Operating the menu screen

MENU Start

Press the **MENU** button to display the QUICK MENU.

Selected item (orange) Input source name

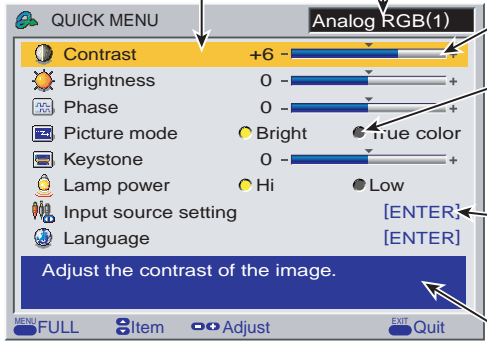

Adjustment display bar
Displayed for adjustable items

Setting display buttons
Displayed for items set by selection.
The setting displayed in yellow is the one currently set.

ENTER There are also items with sub-menus displayed by pressing the **ENTER** button.

ENTER Some items in the FULL MENU have sub-menus.

In the QUICK MENU screen, simple explanations of the selected items are displayed.

The button operation guide is displayed here.

The contents of the operation guide differ according to the type of menu and the selected item.

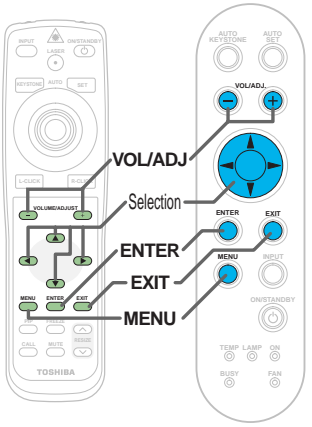

MENU
The FULL MENU appears when the **MENU** button is pressed.

Use the selection buttons (▲/▼) to select the item to be adjusted or set.

Use the VOL/ADJ (+/-) buttons to adjust or set the selected items.

End

Press the **EXIT** button to end the adjustments and settings and turn the menu off.

Adjustments and settings that have been made here are automatically stored in the memory when the power is turned off by the **ON/STANDBY** button.

Sub-menu (example: input setting)

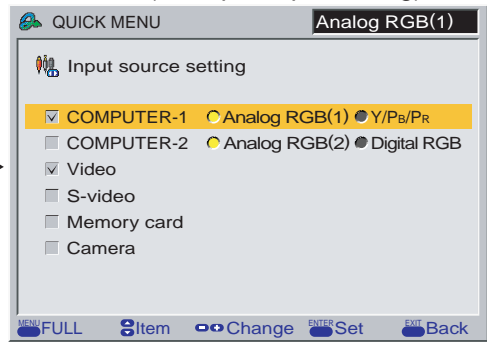

The sub-menus include items that are set by pressing the **ENTER** button.
When a sub-menu is displayed, it will return to the previous menu by pressing the **EXIT** button.

The first menu displayed in the FULL MENU mode is the "Picture" menu.

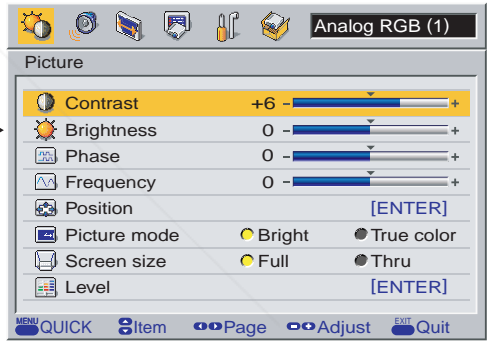

When the **MENU** button is pressed in the FULL MENU mode, the QUICK MENU reappears.

Each press of the selection buttons (◀/▶) change the menus as shown:

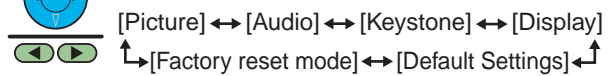

QUICK MENU adjustments and settings

You can set the basic setting used frequently.

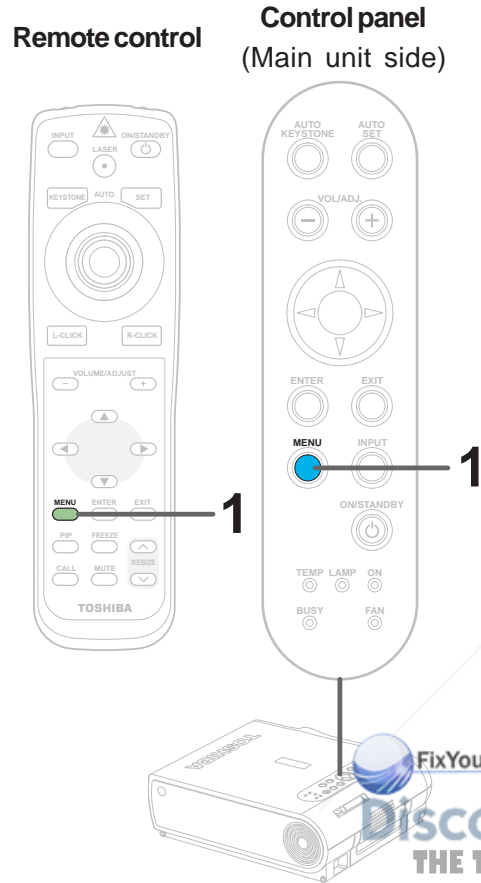

Preparation

1 Project a picture on the screen as explained in the step "Projection on the screen". 28

1

MENU



MENU



Press MENU.

The QUICK MENU appears.

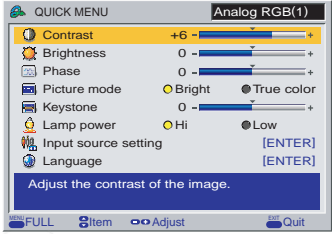

- To cancel the QUICK MENU screen, press the **EXIT** button.
- The contents of the menu are different depending on the type of input source currently selected.

FixYourDLP.com
Sponsored by
Discount-Merchant.com (800) 281-8860
THE TRUSTED SOURCE FOR PROJECTOR LAMPS AND ACCESSORIES

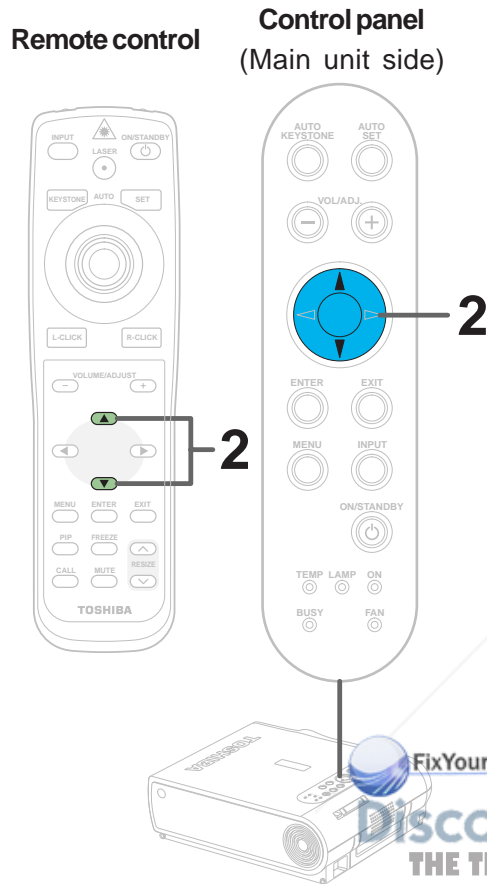

2

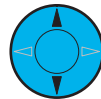

Use the selection buttons (▲ / ▼) to select the adjustment and setting items.

The types of adjustment and setting items are different depending on the type of input source currently selected. (See the table below.)

Adjustments O: Adjustable X: Not displayed

| Items | Inputs | Analog RGB1 | Analog RGB2 | Digital RGB | Y/Pb/Pr | Video | S-video | Memory Card | Document Imaging Camera |
|------------|--------------------------------|-------------|-------------|-------------|---------|-------|---------|-------------|-------------------------|
| Contrast | | O | O | O | O | O | O | O | O |
| Brightness | | O | O | O | O | O | O | O | O |
| Color | | X | X | X | O | O | O | X | X |
| Phase | | O | O | X | X | X | X | X | X |
| Keystone | O (same for all of the inputs) | | | | | | | | |

Settings O: Adjustable X: Not displayed

| Items | Inputs | Analog RGB1 | Analog RGB2 | Digital RGB | Y/Pb/Pr | Video | S-video | Memory Card | Document Imaging Camera |
|----------------------|--------------------------------|-------------|-------------|-------------|---------|-------|---------|-------------|-------------------------|
| Picture mode | | O | O | O | X | X | X | X | X |
| Lamp power | O (same for all of the inputs) | | | | | | | | |
| Input source setting | O (same for all of the inputs) | | | | | | | | |
| Language | O (same for all of the inputs) | | | | | | | | |
| Auto. demo | | X | X | X | X | X | X | O | X |
| Interval | | X | X | X | X | X | X | O | X |
| Shutter | | X | X | X | X | X | X | X | O |



Note

The “Keystone” adjustment and the “Lamp Power”, “Input source setting” and “Language” settings are applied to all the input sources. (It is impossible to make different settings for each input source.)

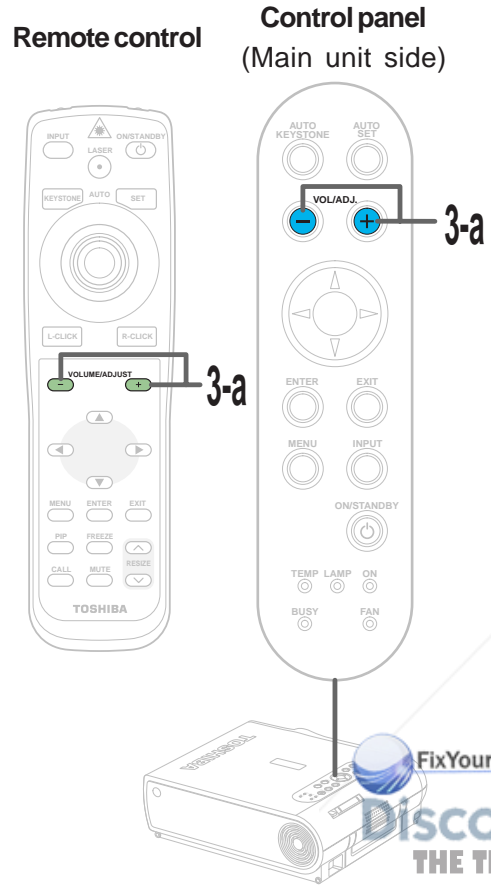
Other items marked “O” can be adjusted or set respectively for the different input sources.



When selecting "Contrast", "Brightness", "Color", "Phase", "Keystone", "Picture mode", "Lamp power", "Auto. demo" or "Shutter" in step 2.

3-a   **Press VOL/ADJ (+/-) to adjust and set.**

Adjustments

| Items | Buttons | (-) | (+) |
|------------|---------|------------------------|------------------------|
| Contrast | | Lower | Higher |
| Brightness | | Darker | Brighter |
| Color | | Thinner | Deeper |
| Phase | | Adjust flickers | Adjust flickers |
| Keystone | | Reduce the lower width | Reduce the upper width |

Settings

Picture mode (Analog RGB input, digital RGB input)

Bright: Set the picture with its brightness priority.
True color: Set the picture with its quality (color) priority.

Lamp power

Hi: Set the lamp mode with brightness priority.
Low: Restrict the lamp output to reduce the cooling sound.

Auto. demo (Memory card input)

On: When a memory card is detected while the memory card input mode is selected, a slide show using the image data in the root directory starts automatically.

Shutter (Document imaging camera input)

Set to the frequency (50/60 Hz) of the power supply in your area.

FixYourDLP.com
Sponsored by

Discount-Merchant.com (800) 281-8860
THE TRUSTED SOURCE FOR PROJECTOR LAMPS AND ACCESSORIES

Note

The cooling sound changes according to the temperature inside the projector. When the lamp power setting is changed, the brightness changes immediately, but the cooling sound level does not change immediately.

Continued

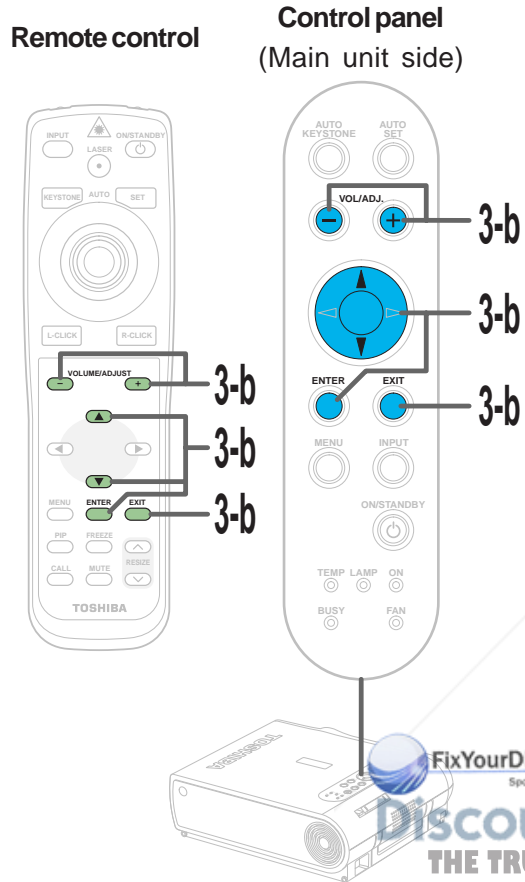

When selecting "Input source setting" in step 2. (Set the input source that can be selected by the **INPUT** button.)

3-b Press ENTER.

The sub-menu screen of input source setting appears.

| Menu items | Main unit indication |
|-------------|--------------------------------------------------------|
| COMPUTER-1 | COMPUTER IN 1 |
| COMPUTER-2 | COMPUTER IN 2 |
| Video | VIDEO |
| S-video | S-VIDEO |
| Memory card | |
| Camera | Document imaging camera (For the model with camera) |

Use the selection buttons (▲ / ▼) to select the input source to be set, then press ENTER to check it.

- The check turns on and off each time the **ENTER** button is pressed.
- When a check box is checked, that input source can be selected by the **INPUT** button.

(When selecting **COMPUTER-1** and **COMPUTER-2**)
Press VOL/ADJ (+/-) to select the type of input source.
 The setting whose button is displayed in yellow is the one currently selected.

Press EXIT to return to the QUICK MENU.

Notes

Discount-Merchant.com (800) 281-8860

THE TRUSTED SOURCE for all your information needs

- It is impossible to exit from the menu if no input source is selected.
- If the check in the check box for the currently selected source is removed, the setting becomes effective the next time the input is changed.
- For the memory card and document imaging camera, there are modes in which these can be selected even if their check box is not checked. **56** **77**

When selecting "Language" in step 2. (Set the language used in the menu display.)

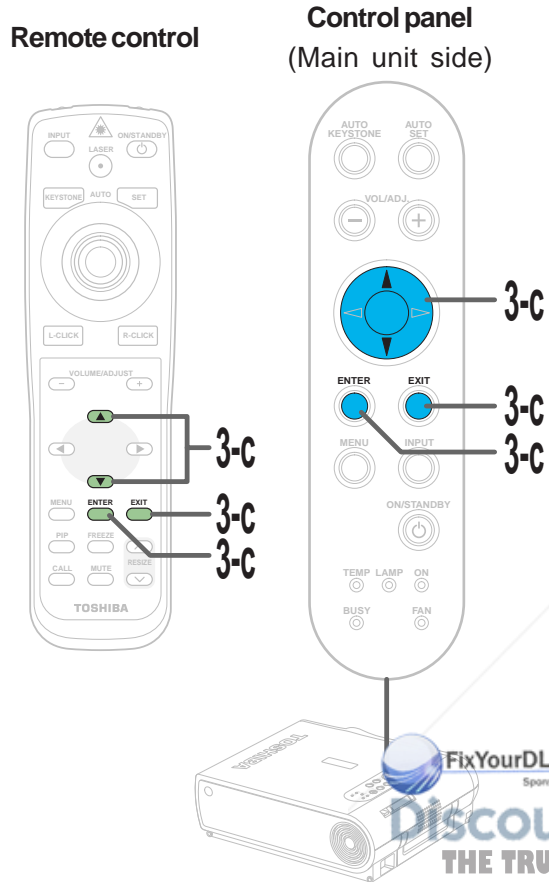

3-C

ENTER

Press **ENTER**.
The sub-menu screen of language setting appears.

ENTER

Use the selection buttons (▲ / ▼) to select a language.

EXIT

Press **EXIT** to return to the QUICK MENU.

| | |
|------------------|-------------------------|
| English | : English |
| Français | : French |
| Deutsch | : German |
| Italiano | : Italian |
| Español | : Spanish |
| Português | : Portuguese |
| 日本語 | : Japanese |
| 简体字 | : Chinese (Simplified) |
| 繁體字 | : Chinese (Traditional) |
| 한국어 | : Korean |

When selecting "Interval" in step 2. (Set the interval time of the automatic slide show.)

3-d

ENTER



ENTER



Press ENTER.

The sub-menu screen of interval setting appears.

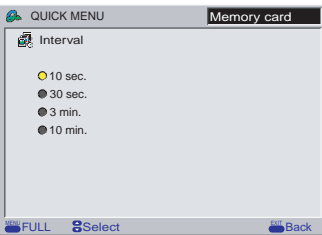

3-d



Use the selection buttons (▲ / ▼) to select interval time.

10 sec.
30 sec.
3 min.
10 min.

Depending on the compression format of the JPEG files, it may take more time than the setting value.

4

EXIT



EXIT



Press EXIT to return to the QUICK MENU.

4

EXIT



EXIT



After the adjustments and settings are finished, press EXIT.

The menu screen disappears.

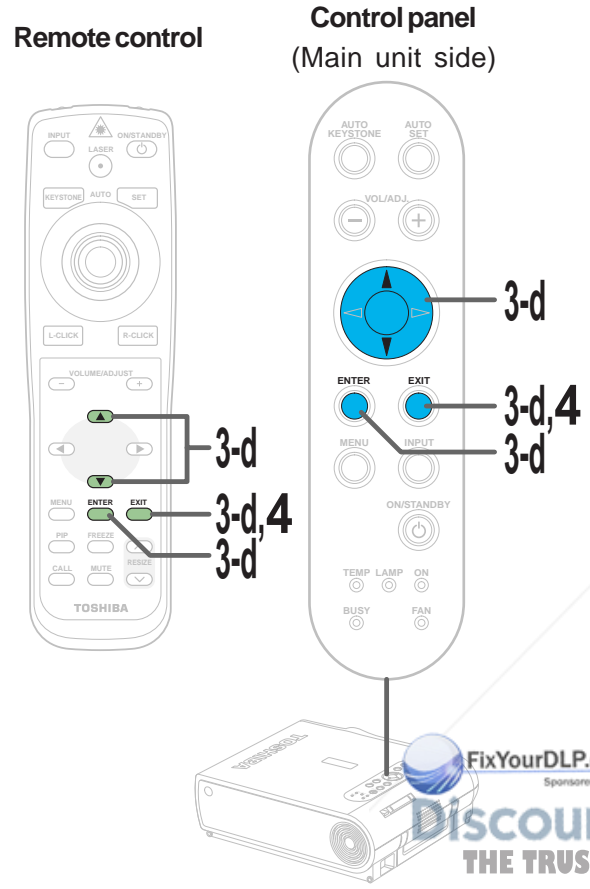

FixYourDLP.com
Sponsored by

Discount-Merchant.com (800) 281-8860
THE TRUSTED SOURCE FOR PROJECTOR REPAIRS

Notes

- If the power is turned off by pressing the ON/STANDBY button, the adjustments or settings made are automatically stored in the memory. If the power cord is unplugged or if a power failure occurs while the projector is on, the adjustments or settings are not stored in the memory.
- The adjustments or settings are stored for each of the items marked "O" in the table in step 2.

FULL MENU adjustments and settings – Picture

You can adjust contrast, brightness, color level, image position, etc.

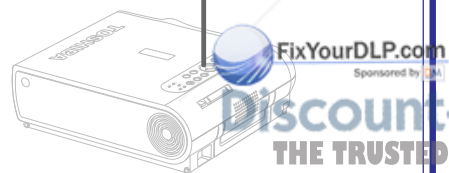
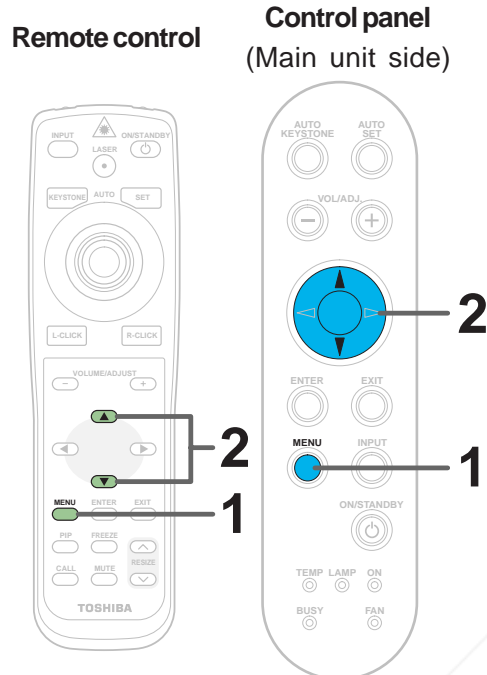

Preparation

1 Project a picture on the screen as explained in the step “Projection on the screen”. 28

1



Press MENU twice.

When pressed once, the QUICK MENU screen appears. When pressed twice, the “Picture” screen of the FULL MENU appears.

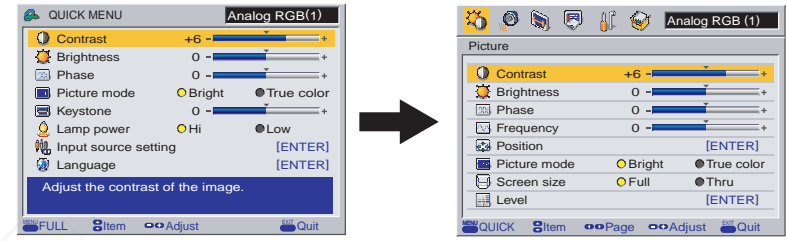

2

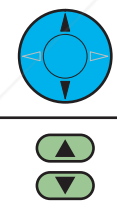

Use the selection buttons (▲ / ▼) to select the adjustment and setting items.

The types of adjustment and setting items are different depending on the type of input source currently selected. (See the table below.)

O: Adjustable X: Not displayed

| Items | Adjustments | | | | | | | | |
|------------|-------------|-------------|-------------|-------------|---------|-------|---------|-------------|-------------------------|
| | Inputs | Analog RGB1 | Analog RGB2 | Digital RGB | Y/Pb/Pr | Video | S-video | Memory Card | Document Imaging Camera |
| Contrast | | O | O | O | O | O | O | O | O |
| Brightness | | O | O | O | O | O | O | O | O |
| Color | | X | X | X | O | O | O | X | X |
| Tint | | X | X | X | O*1 | O*2 | O*2 | X | X |
| Sharpness | | X | X | X | O*1 | O | O | X | O |
| Phase | | O | O | X | X | X | X | X | X |
| Frequency | | O | O | X | X | X | X | X | X |
| Position | | O | O | O | X | X | X | X | X |
| Level | | O | O | O | O | O | O | O | O |

*1: Adjustment is impossible at 480i mode.

*2: Adjustment is impossible at PAL/SECAM.

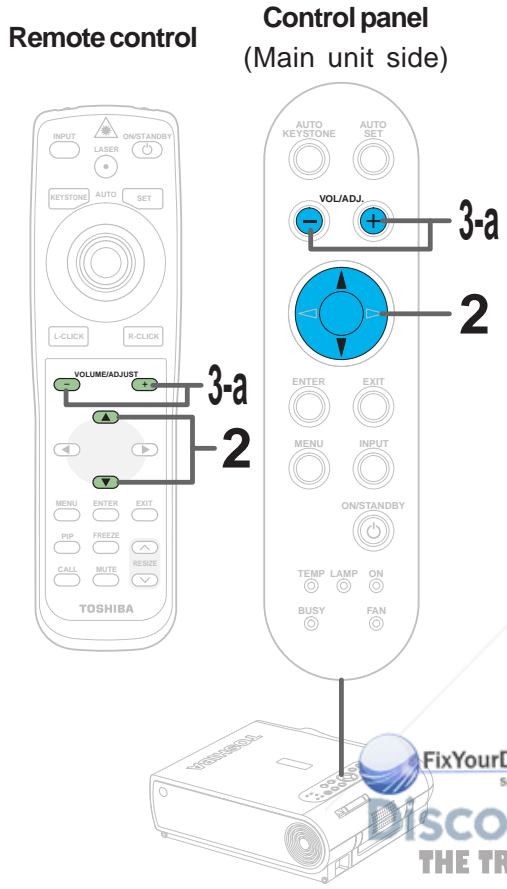

2
(Continued)

| Settings | | O: Settable X: Not displayed | | | | | | | |
|-------------------|--------|------------------------------|-------------|-------------|---------|-------|---------|-------------|-------------------------|
| Items | Inputs | Analog RGB1 | Analog RGB2 | Digital RGB | Y/Pb/Pr | Video | S-video | Memory Card | Document Imaging Camera |
| Picture mode | | O | O | O | X | X | X | X | X |
| Screen size | | O | O | O | O | O | O | O | O |
| Signal format | | X | X | X | O | X | X | X | X |
| Video mode | | X | X | X | X | O | O | X | X |
| Input select mode | | X | X | X | X | X | X | O | X |
| Auto. demo | | X | X | X | X | X | X | O | X |
| Slide show | | X | X | X | X | X | X | O | X |
| Interval | | X | X | X | X | X | X | O | X |
| Shutter | | X | X | X | X | X | X | X | O |

When selecting "Contrast", "Brightness", "Color", "Tint", "Sharpness", "Phase", "Frequency", "Picture mode", "Screen size", "Input select mode", "Auto. demo" or "Slide show" in step 2.

3-a

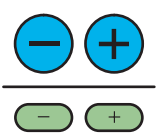

Press VOL/ADJ (+/-) to adjust and set.

| Adjustments | | | |
|-------------|---------|-------------------------|-------------------------|
| Items | Buttons | (-) | (+) |
| Contrast | | Lower | Higher |
| Brightness | | Darker | Brighter |
| Color | | Thinner | Deeper |
| Tint | | Redder | Greener |
| Sharpness | | Softer | Sharper |
| Phase | | Adjust flickers | Adjust flickers |
| Frequency | | Adjust vertical stripes | Adjust vertical stripes |

FixYourDLP.com
Sponsored by
Discount-Merchant.com (800) 281-2860
THE TRUSTED SOURCE FOR PROJECTOR LAMPS AND ACCESSORIES

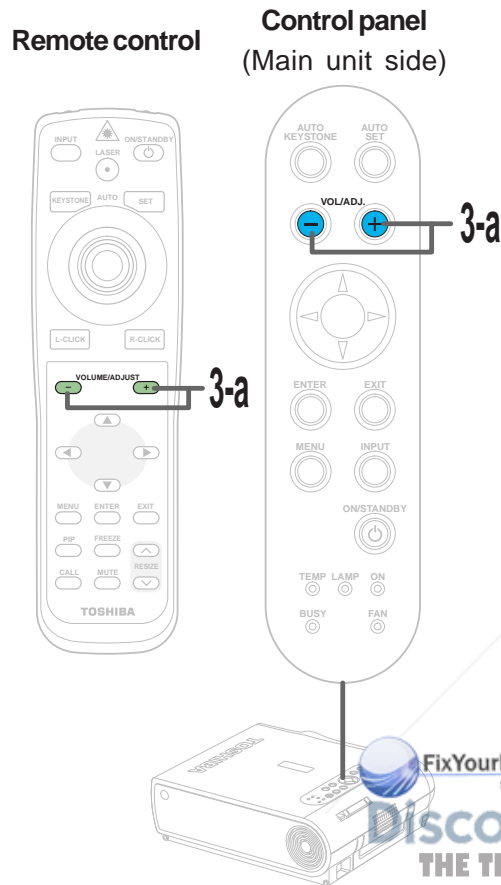

3-a
(Continued)

Settings

Picture mode (RGB input)

Bright: Set the picture with its brightness priority.
True color: Set the picture with its quality (color) priority.

Screen size

Full: Images are converted to display in 1024 x 768 dots. In the memory card input mode, if the image data's aspect ratio is anything other than 4:3, the image is adjusted so that either the width or the height (the larger of the two) becomes full size. Note that images of 640 x 480 dots or smaller cannot be displayed in full size.

Thru: Images are displayed in the input resolution. Parts larger than 1024 x 768 dots are not displayed. Note that only signal sources whose clock frequency is 140 MHz or less can be displayed at the input resolution.

Wide: To display a wide screen image compressed in a left-right squeeze operation by a DVD player, etc. in an original wide screen size.

Input select mode (Memory card input)

Auto: Regardless of the setting by the "Input source setting" menu, the input source automatically switches to the memory card input mode when a memory card is detected.

Manual: Set the mode according to the setting by the "Input source setting" menu.

Auto. demo (Memory card input)

On: When a memory card is detected while the memory card input mode is selected, a slide show using the image data recorded in the root directory of memory card starts automatically.

Slide show (Memory card input)

You can set when the "Auto. demo" is Off.

Auto: Execute the slide show automatically.

Manual: Execute the slide show manually.

Shutter (Document imaging camera)

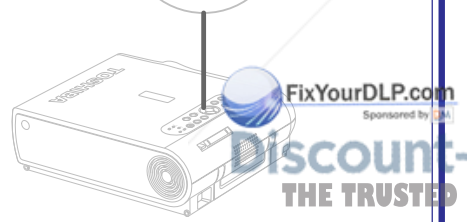
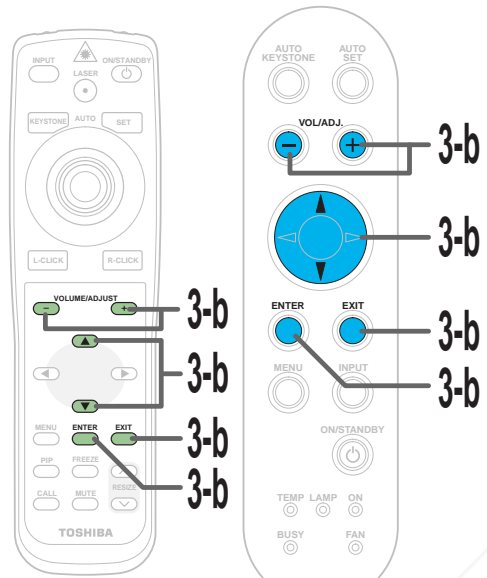

Set to the frequency (50/60 Hz) of the power supply in your area.

Remote control Control panel (Main unit side)



When selecting "Position" or "Level" in step 2.

3-b

ENTER

ENTER

Press ENTER.
 The sub-menu of selected items appears.

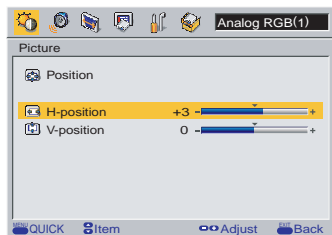
"Position"



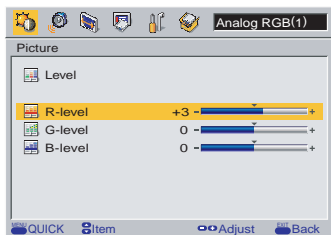

"Level"



Use the selection buttons (▲ / ▼) to select adjustment items.

Press VOL/ADJ (+/-) to adjust.

| Items | Buttons | (-) | (+) |
|----------|------------|---------------------------|----------------------------|
| Position | H-position | Move the picture leftward | Move the picture rightward |
| | V-position | Move the picture down | Move the picture upward |
| Level | R-level | To reduce red | To increase red |
| | G-level | To reduce green | To increase green |
| | B-level | To reduce blue | To increase blue |

EXIT

EXIT

Press EXIT to return to the FULL MENU.

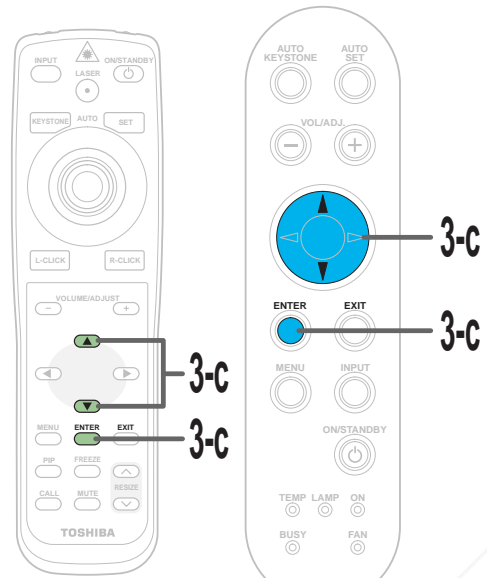
Remote control Control panel (Main unit side)



When selecting "Signal format", "Video mode" or "Interval" in step 2.

3-C

ENTER



ENTER



Press ENTER.

The sub-menu of selected items appears.

"Signal format"

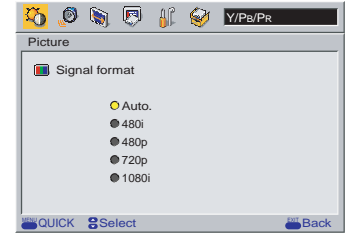

"Video mode"

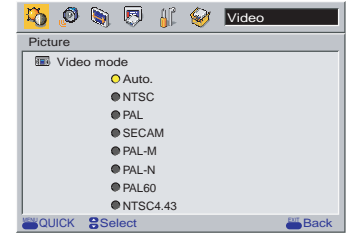

"Interval"

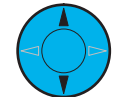
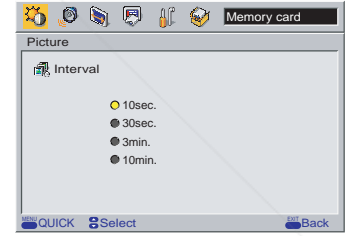

Use the selection buttons (▲ / ▼) to select setting items.



Signal format (Y/P_B/P_R input)

Auto: Determine the type of the signal input automatically. If not determined properly, select among the signals shown below.
480i, 480p, 720p, 1080i

Video mode (Video input, S-video input)

Auto: Determine the type of the signal input automatically. If not determined properly, select among the signals shown below.
NTSC, PAL, SECAM, PAL-M, PAL-N, PAL60, NTSC4.43

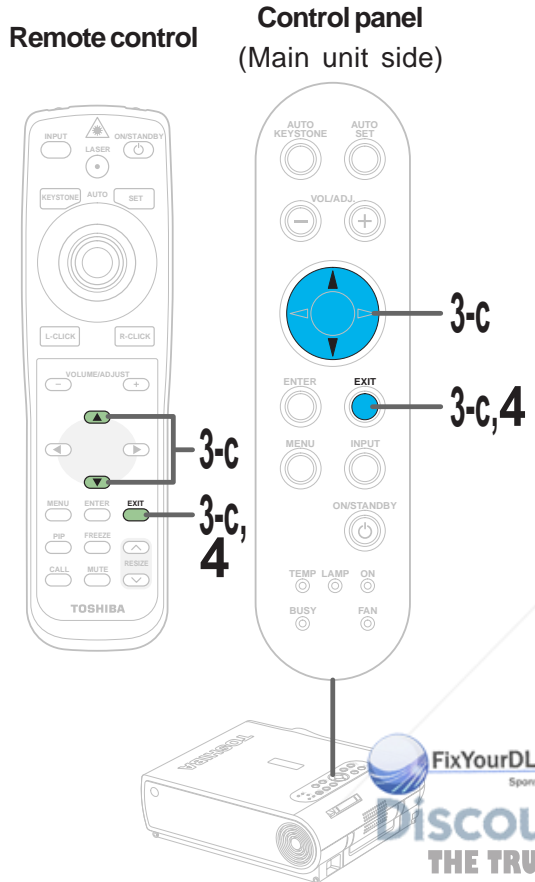

3-c (Continued)

Interval (Memory card input)
 Select the display interval (time) for the auto. demo and auto. slide show. (10 sec., 30 sec., 3 min. or 10 min.)
 Depending on the compression format of the JPEG files, it may take more time than the setting value.

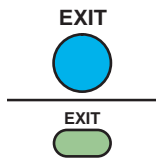

Press EXIT to return to the FULL MENU.

4

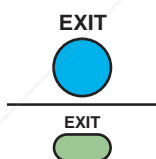

After the adjustments and settings are finished, press EXIT.
 The menu screen disappears.

Notes

- If the power is turned off by pressing the **ON/STANDBY** button, the adjustments or settings made are automatically stored in the memory. If the power cord is unplugged or if a power failure occurs while the projector is on, the adjustments or settings are not stored in the memory.
- The adjustments or settings are stored for each of the items marked "O" in the table in step 2. (It is impossible to store adjustments for each video mode or signal format.)

FULL MENU settings – Audio

You can set the audio signals developed from the speaker. (The speaker output is monaural.)

Preparation

1 Project a picture on the screen as explained in the step “Projection on the screen”. 28

Remote control Control panel (Main unit side)

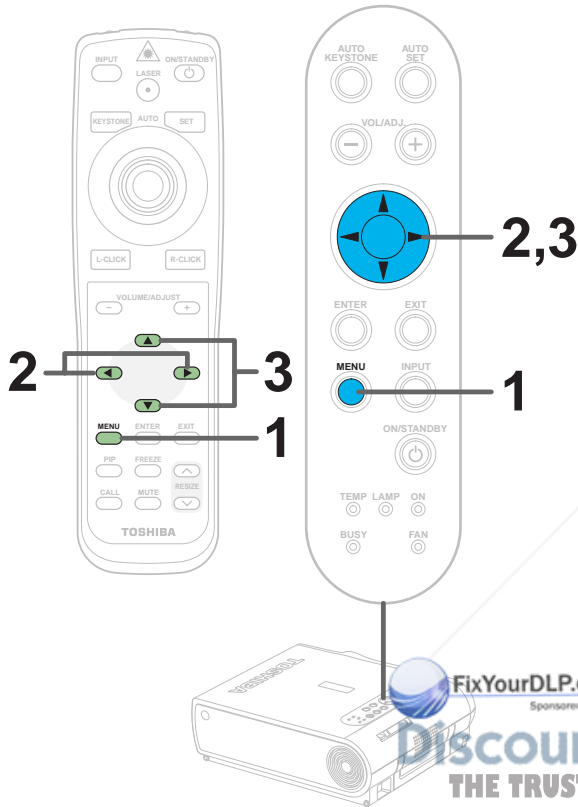

1

MENU



MENU



Press MENU twice.

When pressed once, the QUICK MENU screen appears. When pressed twice, the “Picture” screen of the FULL MENU appears.

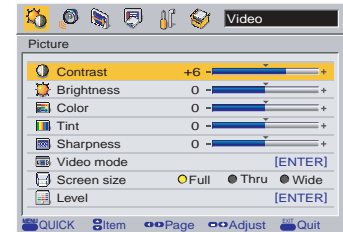
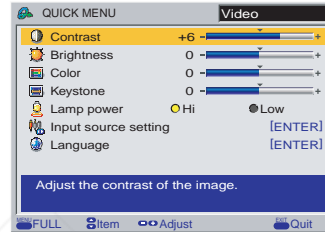

2

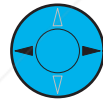

Use the selection button (▶) to display the “Audio” menu.

If you pass by the “Audio” menu, press the selection button (◀) to move back to it.

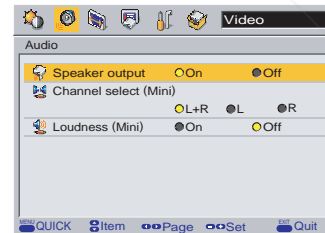

3

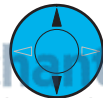

Use the selection buttons (▲ / ▼) to select the setting items.

(RCA): Audio input jack (R-AUDIO-L) of VIDEO IN
(Mini): AUDIO IN jack

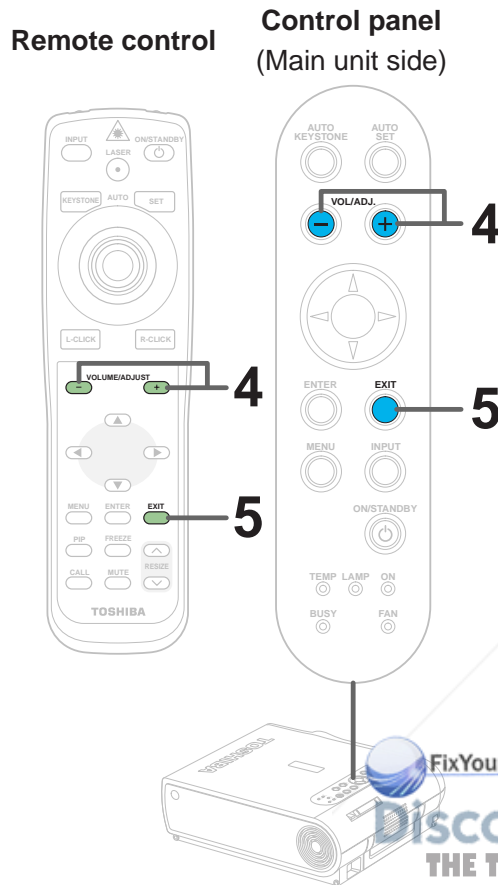

4

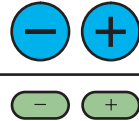

Press VOL/ADJ (+/-) to adjust and set.

Speaker output

When set to “Off”, no sound is produced from the speakers.

Channel select

L+R: The sound of the left and right channels is mixed and developed from the speakers.

L: To develop only left input audio signal from the speakers.

R: To develop only right input audio signal from the speakers.

Loudness

When set to “On”, the loudness effect is added to the speaker sound.

5

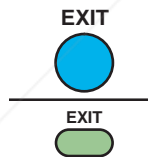

After the settings are finished, press EXIT.

The menu screen disappears.

Notes

- If the power is turned off by pressing the **ON/STANDBY** button, the adjustments or settings made are automatically stored in the memory. If the power cord is unplugged or if a power failure occurs while the projector is on, the adjustments or settings are not stored in the memory.
- The “Audio” settings are applied to all the input sources. (It is impossible to change the settings for each input source.)
- The settings do not affect the audio output signals from the AUDIO OUT jack.
- If either the memory card input or the document imaging camera input mode (for models with document imaging camera) is selected, the sound is not developed.

FULL MENU settings – Keystone

- If the screen is not installed vertically, you can adjust the keystone distortion manually.
- The projector stores the standard conditions of horizontal installation, but depending on the usage environment (if the projector is subject to vibrations or shock, etc.), the standard may change. If the keystone distortion is not properly corrected when the **AUTO KEYSTONE** button is pressed with the screen installed vertically, set the projector on a flat surface then use the menu screen's "Horizontal reference value reset" function.

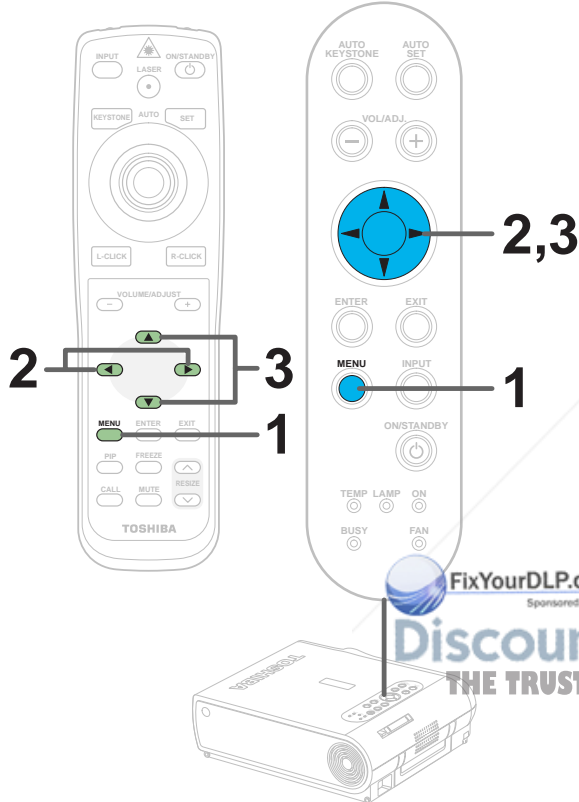

Remote control Control panel (Main unit side)



Preparation

1 Project a picture on the screen as explained in the step "Projection on the screen". 28

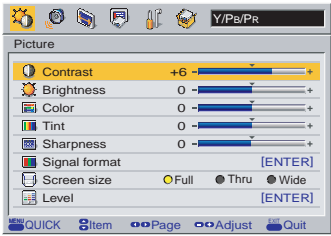
1  **Press MENU twice.**
When pressed once, the QUICK MENU screen appears. When pressed twice, the "Picture" screen of the FULL MENU appears.

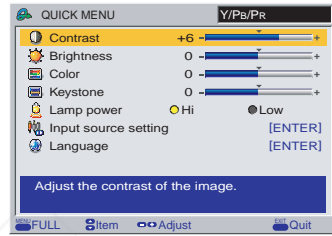

2  **Use the selection buttons (◀/▶) to display the "Keystone" menu.**

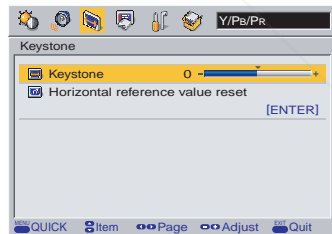

3  **Use the selection buttons (▲/▼) to select the setting items.**



Adjustments & Settings

FixYourDLP.com
Discount-Merchant.com (800) 281-8860
THE TRUSTED SOURCE FOR PROJECTOR LAMPS AND ACCESSORIES

FULL MENU settings – Keystone (continued)

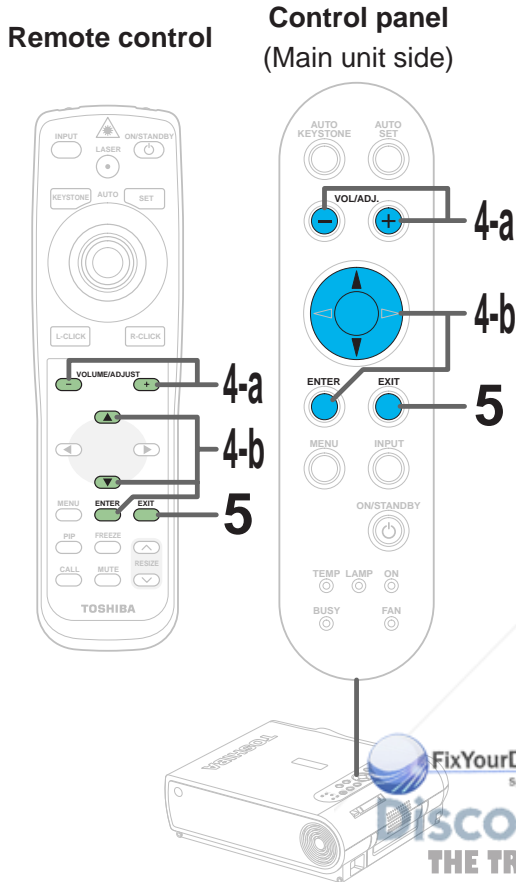

When selecting "Keystone" in step 3.

4-a

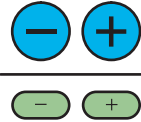

Press VOL/ADJ (+/-) to adjust and set.

(-) (+)

Keystone: To reduce the lower width To reduce the upper width

When selecting "Horizontal reference value reset" in step 3.

4-b

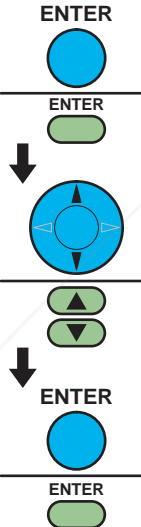

Press ENTER.

The sub-menu of "Horizontal reference value reset" appears.

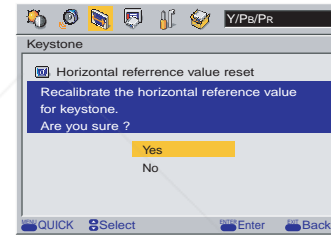

Use the selection buttons (▲ / ▼) to select "Yes" and press ENTER.

The horizontal reference value is reset.

5

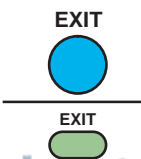

After the adjustments and settings are finished, press EXIT several times until the menu screen disappears.

Press the EXIT button once when the FULL MENU is displayed, press twice when the sub menu is displayed.

Notes

- If the power is turned off by pressing the ON/STANDBY button, the adjustments or settings made are automatically stored in the memory. If the power cord is unplugged or if a power failure occurs while the projector is on, the adjustments or settings are not stored in the memory.
- The "Keystone" adjustments and settings are applied to all the input sources. (It is impossible to store different adjustments and settings for each input source.)

FULL MENU settings – Display

You can set the language, menu display and start-up screen, etc.

Preparation

1 Project a picture on the screen as explained in the step “Projection on the screen”. 28

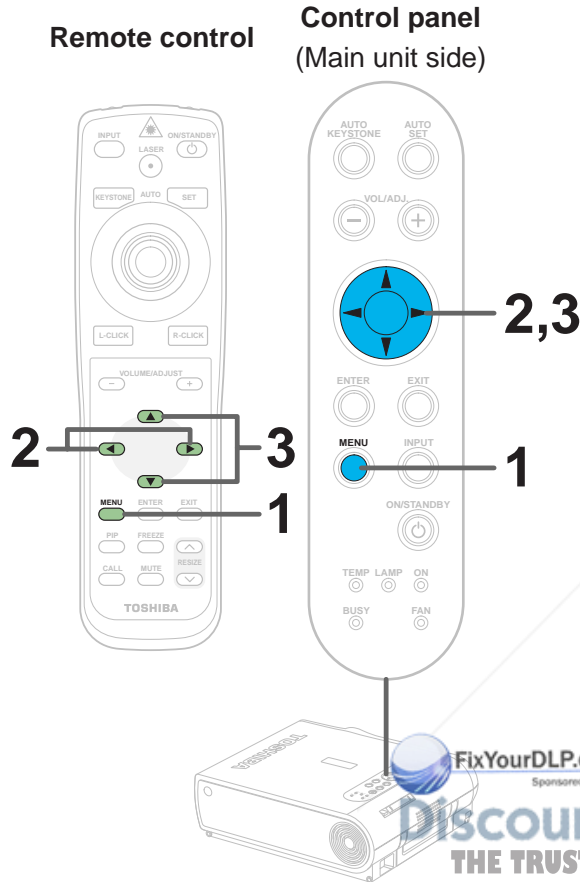

1

MENU



Press MENU twice.

When pressed once, the QUICK MENU screen appears. When pressed twice, the “Picture” screen of the FULL MENU appears.

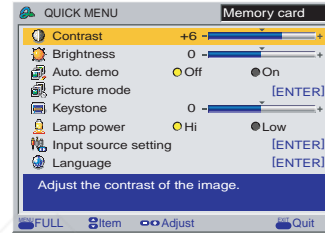

2

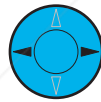

Use the selection buttons (◀/▶) to display the “Display” menu.

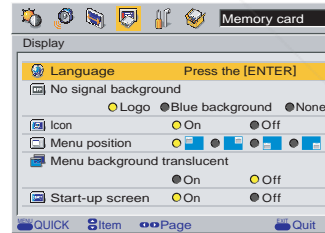

3



Use the selection buttons (▲/▼) to select the setting items.



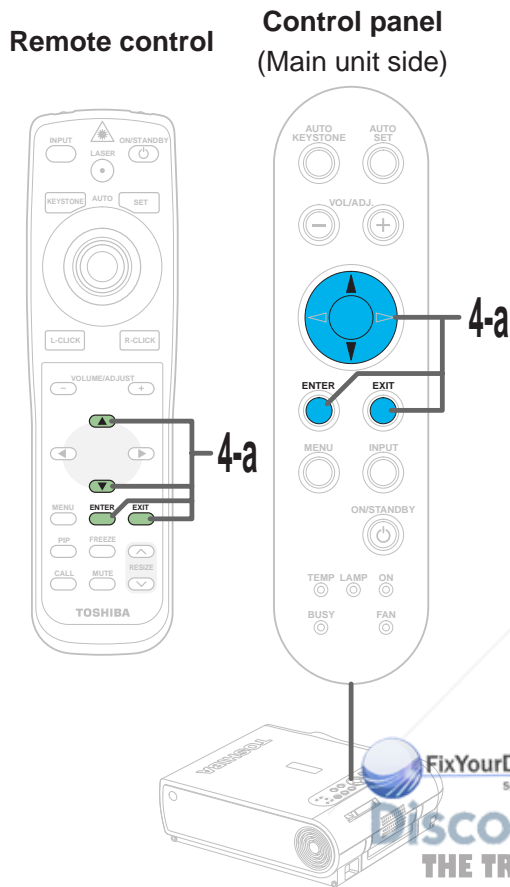

When selecting "Language" in step 3.

4-a

ENTER

Press ENTER.
The sub-menu of "Language" appears.

ENTER

↓

Use the selection buttons (▲ / ▼) to select a language.

| | |
|------------------|-------------------------|
| English | : English |
| Français | : French |
| Deutsch | : German |
| Italiano | : Italian |
| Español | : Spanish |
| Português | : Portuguese |
| 日本語 | : Japanese |
| 简体字 | : Chinese (Simplified) |
| 繁體字 | : Chinese (Traditional) |
| 한국어 | : Korean |

↓

EXIT

Press EXIT to return to the FULL MENU.

EXIT

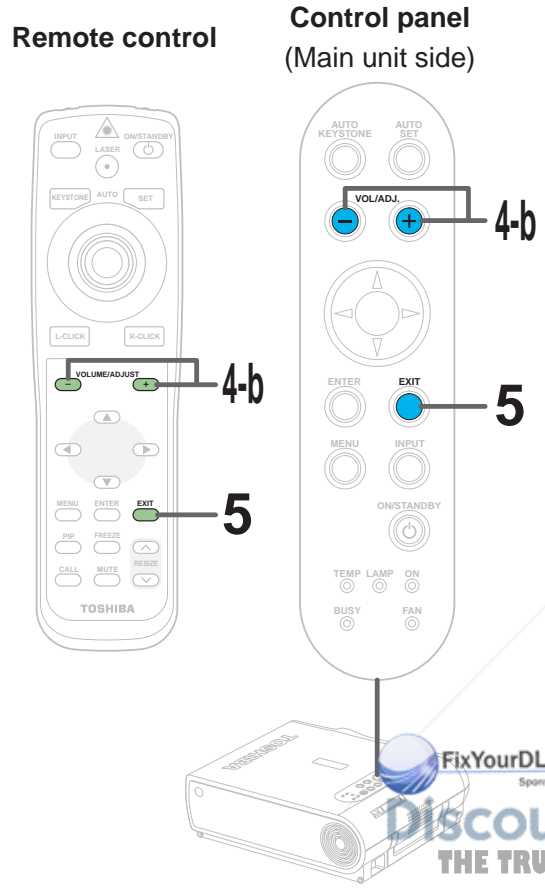

When selecting setting items other than "Language" in step 3.

4-b

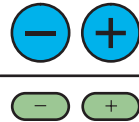

Press VOL/ADJ (+/-) to adjust and set.

No signal background (Setting of screen of no signal input)

- Logo: The TOSHIBA logo screen is displayed.
- Blue background: The entire screen is blue.
- None: The screen is black.

Icon

When set to "Off", the icons displayed normally when the input is changed or other operations are performed, are no longer displayed.

Menu position

Select the position where the menu is displayed ("Upper left", "Upper right", "Bottom left" or "Bottom right").

Menu background translucent

When set to "On", the menu background becomes translucent.

Start-up screen

When set to "On", the opening screen is displayed when the power is turned on.

5

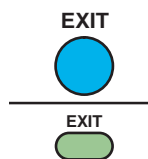

After the settings are finished, press EXIT.

The menu screen disappears.

Notes

- If the power is turned off by pressing the **ON/STANDBY** button, the adjustments or settings made are automatically stored in the memory. If the power cord is unplugged or if a power failure occurs while the projector is on, the adjustments or settings are not stored in the memory.
- The "Display" settings are applied to all the input sources. (It is impossible to store different settings for each input source.)

FixYourDLP.com
Sponsored by
Discount-Monitors.com
THE TRUSTED SOURCE FOR PROJECTOR LAMPS AND ACCESSORIES

FULL MENU settings – Default setting

You can set the input source which can be selected by the **INPUT** button; you can also set the projection mode, power off at no signal status, power on mode and lamp power.

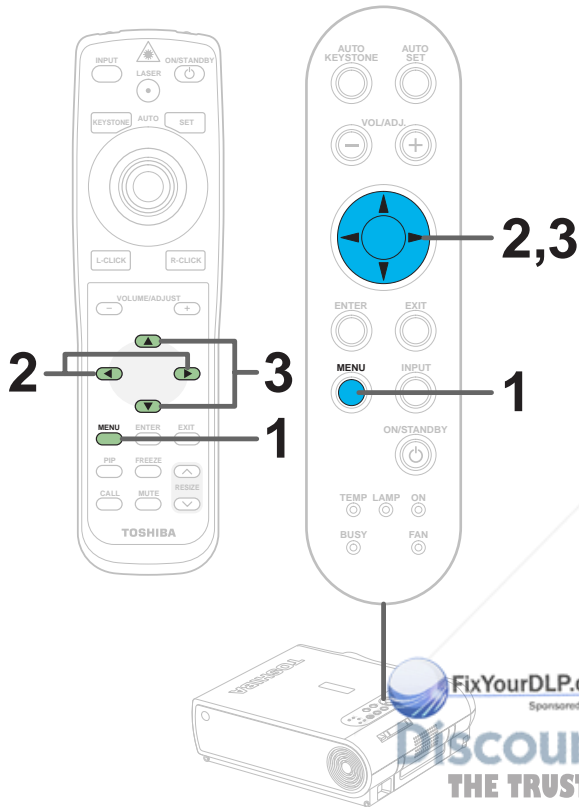

Remote control Control panel (Main unit side)



Preparation

1 Project a picture on the screen as explained in the step “Projection on the screen”. 28

1



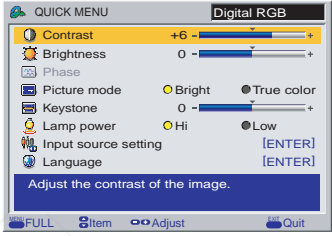
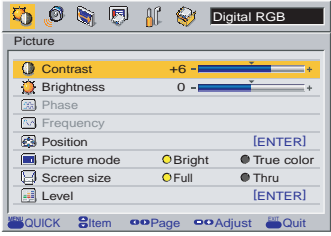

Press MENU twice.

When pressed once, the QUICK MENU screen appears. When pressed twice, the “Picture” screen of the FULL MENU appears.

➔

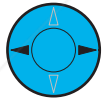

2

Use the selection buttons (◀/▶) to display the “Default setting” menu.

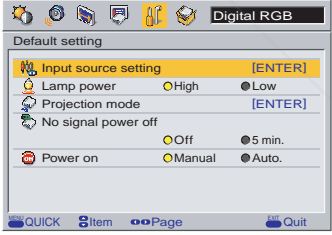

3

Use the selection buttons (▲/▼) to select the setting items.

FixYourDLP.com
Sponsored by
Discount-Merchant.com (800) 281-8860
THE TRUSTED SOURCE FOR PROJECTOR LAMPS AND ACCESSORIES

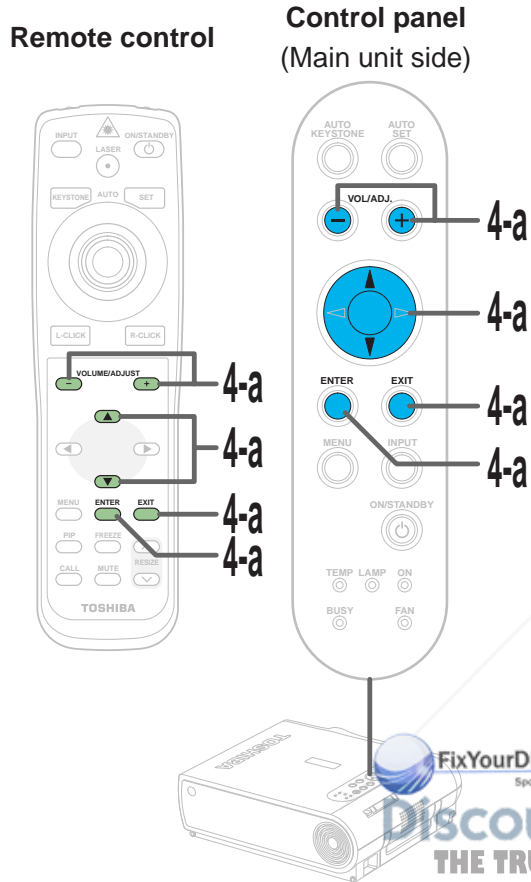

When selecting “Input source setting” in step 3. (Set the input that can be selected using **INPUT** button.)

4-a

ENTER



Press ENTER.

The sub-menu of “Input source setting” appears.

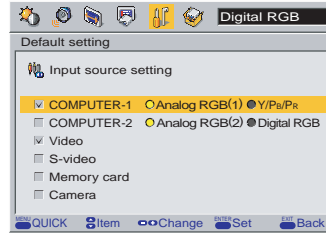

| Menu items | Main unit indication |
|-------------|--------------------------------------------------------|
| COMPUTER-1 | COMPUTER IN 1 |
| COMPUTER-2 | COMPUTER IN 2 |
| Video | VIDEO |
| S-video | S-VIDEO |
| Memory card | |
| Camera | Document imaging camera (For the model with camera) |

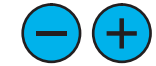
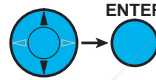

Use the selection buttons (▲ / ▼) to select the input source to be set, then press ENTER to check it.

- The check turns on and off each time the **ENTER** button is pressed.
- When a check box is checked, that input source can be selected by the **INPUT** button.

(When selecting **COMPUTER-1** and **COMPUTER-2**)

Press VOL/ADJ (+/-) to select the type of input source.

The setting whose button is displayed in yellow is the one currently set.

Press EXIT to return to the FULL MENU.

Notes

- It is impossible to exit from the menu if no input source is selected.
- If the check in the check box for the currently selected source is removed, the setting becomes effective the next time the input is changed.
- For the memory card and document imaging camera, there are modes in which these can be selected even if their check box is not checked. **56** **77**

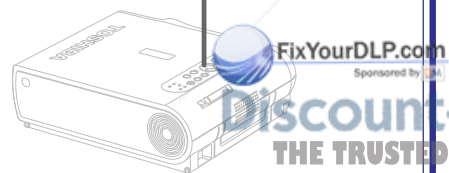
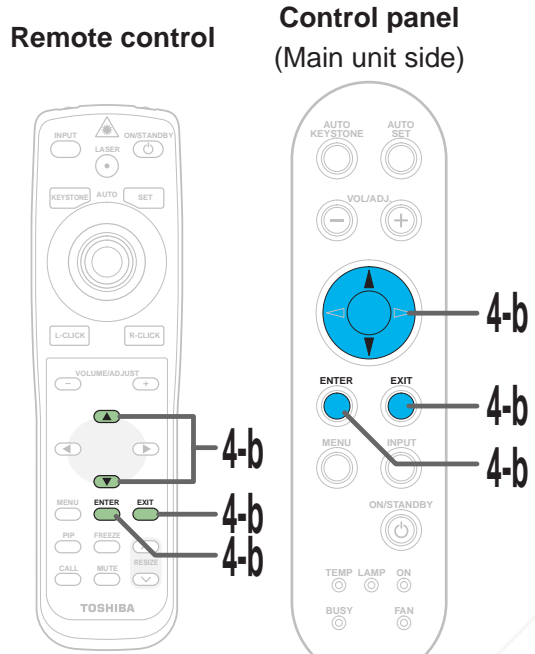

When selecting "Projection mode" in step 3.

4-b

ENTER

Press ENTER.

The sub-menu of "Projection mode" appears.

ENTER

Use the selection buttons (▲ / ▼) to select the projection mode.

Select the installation position of the projector. Confirm by referring to the chart on page 17 21.

| | |
|---------------|----------------------------------|
| Standard: | Floor-mounted front projection |
| Rear: | Floor-mounted rear projection |
| Ceiling: | Ceiling-mounted front projection |
| Rear ceiling: | Ceiling-mounted rear projection |

EXIT

Press EXIT to return to the FULL MENU.

Remote control

Control panel
(Main unit side)

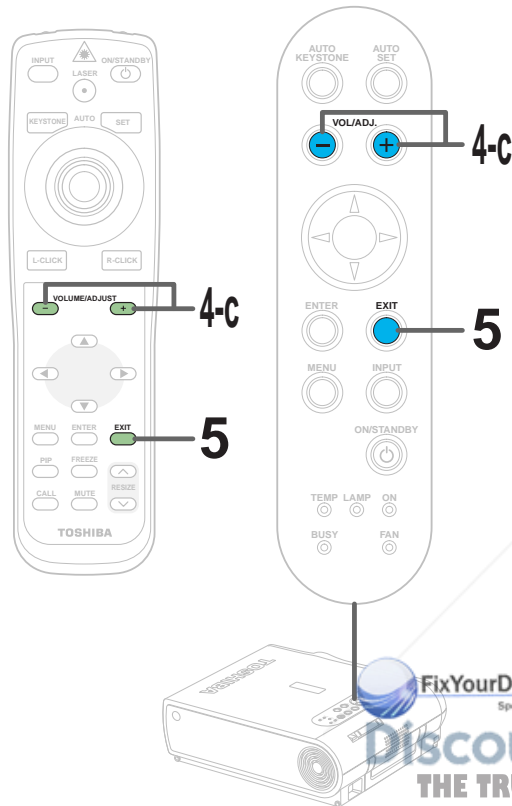

When selecting “No signal power off”, “Power on” or “Lamp power” in step 3.

4-c

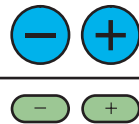

Press VOL/ADJ (+/-) to set.

No signal power off

- OFF: The power does not turn off automatically even if the no signal status continues.
- 5 min.: The power turns off automatically if the no signal status continues for approx. 5 min.

Power on

- Manual: The power turns on by pressing the **ON/STANDBY** button.
- Auto: When the power cord is plugged, the power turns on.

Press the **ON/STANDBY** button when turns power off. **31**

Lamp power

- Hi: Set the lamp mode with brightness priority.
- Low: Restrict the lamp output to reduce the cooling sound.

Note

The cooling sound changes according to the temperature inside the projector. When the lamp power setting is changed, the brightness changes immediately, but the cooling sound level does not change immediately.

5

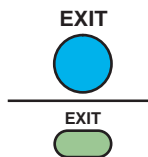

After the settings are finished, press EXIT.

The menu screen disappears.

Notes

- If the power is turned off by pressing the **ON/STANDBY** button, the adjustments or settings made are automatically stored in the memory. If the power cord is unplugged or if a power failure occurs while the projector is on, the adjustments or settings are not stored in the memory.
- The settings of “Default setting” are applied to all the input sources. (It is impossible to store different settings for each input source.)

FULL MENU settings – Factory reset mode

You can return the adjusting or setting value to the factory default setting.



Preparation

1 Project a picture on the screen as explained in the step “Projection on the screen”. 28

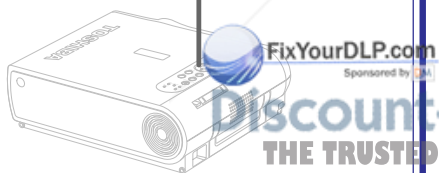
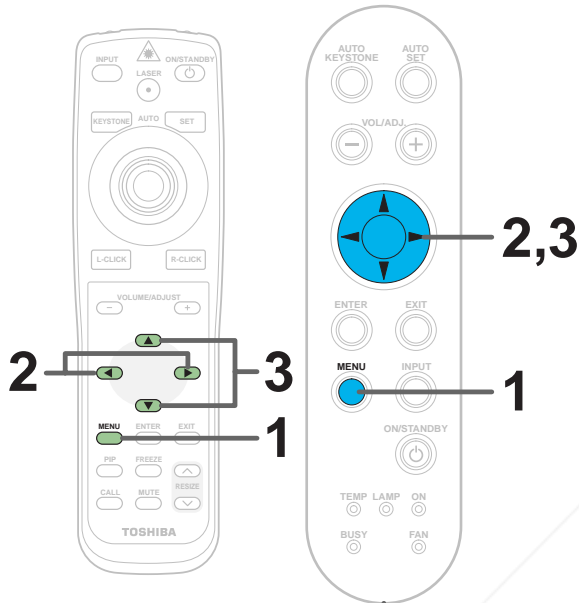
Remote control Control panel (Main unit side)



1  **Press MENU twice.**
When pressed once, the QUICK MENU screen appears. When pressed twice, the “Picture” screen of the FULL MENU appears.

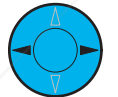

2  **Use the selection buttons (◀ / ▶) to display the “Factory reset mode” menu.**

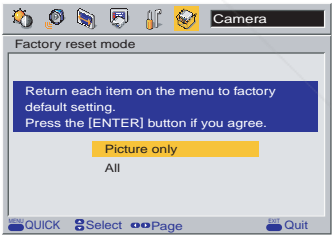

3  **Use the selection buttons (▲ / ▼) to select the setting items.**
Picture only: Reset only the adjustments and settings made on the “Picture” menus for the each input to the factory default setting.
All: Reset all the adjustments and settings for all the inputs to the factory default setting.

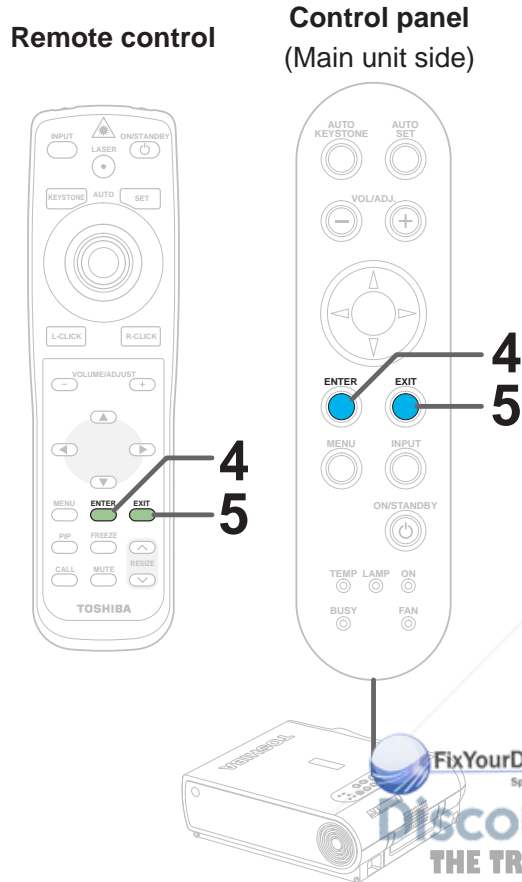

4

ENTER



ENTER



Press ENTER.

The settings are reset to the factory default settings according to the conditions selected in step 3.

5

EXIT



EXIT



After the settings are finished, press EXIT.

The menu screen disappears.

Notes

- If the power is turned off by pressing the **ON/STANDBY** button, the adjustments or settings made are automatically stored in the memory. If the power cord is unplugged or if a power failure occurs while the projector is on, the adjustments or settings are not stored in the memory.
- When the “Factory reset mode” menu is executed, the adjustments and settings for all the inputs return to the factory default settings. (It is impossible to reset them for each input source.)

PIP menu setting

You can make the PIP sub-picture settings and the sound settings when a PIP sub-picture is displayed.

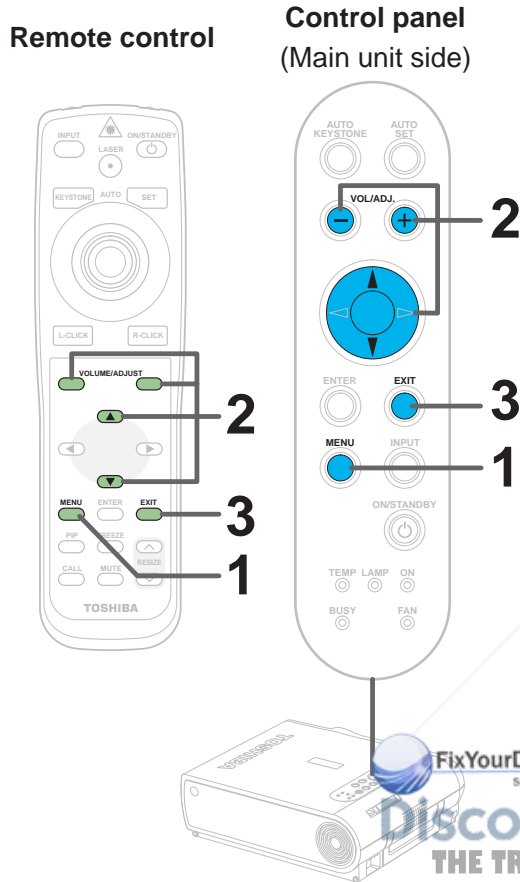

Preparation

1 Display the PIP sub-picture on the screen as explained in the step “Displaying PIP Sub-pictures”. 37

1 Press MENU.

When a PIP sub-picture is displayed, the PIP menu screen appears.

| | | | | |
|----------|------------|-------------|------------|-------------|
| Source | Video | S-Video | | |
| Size | Small | Large | | |
| Position | Upper Left | Upper Right | Lower Left | Lower Right |
| Audio | Main | Sub | | |
| Item | Set | Quit | | |

2 Use the selection buttons (▲ / ▼) to select the setting items, then press VOL/ADJ (+/-) to set.

Source: Set the PIP sub-picture input source.
“Video input” or “S-video input” can be selected.

Size: Set the PIP sub-picture size.
“Small” or “Large”

Position: Set the display position of the PIP sub-picture.
“Upper left”, “Upper right”, “Lower left” or “Lower right”

Audio: Set the audio input source.
The sound of the selected picture (“Main picture” or “Sub-picture”) is output from the speakers and the AUDIO OUT jack.

3 After the settings are finished, press EXIT.

The menu screen disappears.

Adjustments & Settings

Notes

- When the PIP sub-picture is turned off, the audio input source returns to the previous source (main picture).
- If the power is turned off by pressing the **ON/STANDBY** button, the adjustments or settings made are automatically stored in the memory. If the power cord is unplugged or if a power failure occurs while the projector is on, the adjustments or settings are not stored in the memory.

CAUTION

When using the camera, be careful to not pinch your hand or fingers into the arm.

On the document imaging camera model, you can project pictures using the document imaging camera. The document imaging camera can directly project any materials (documents, illustrations, etc.) without using an OHP film.

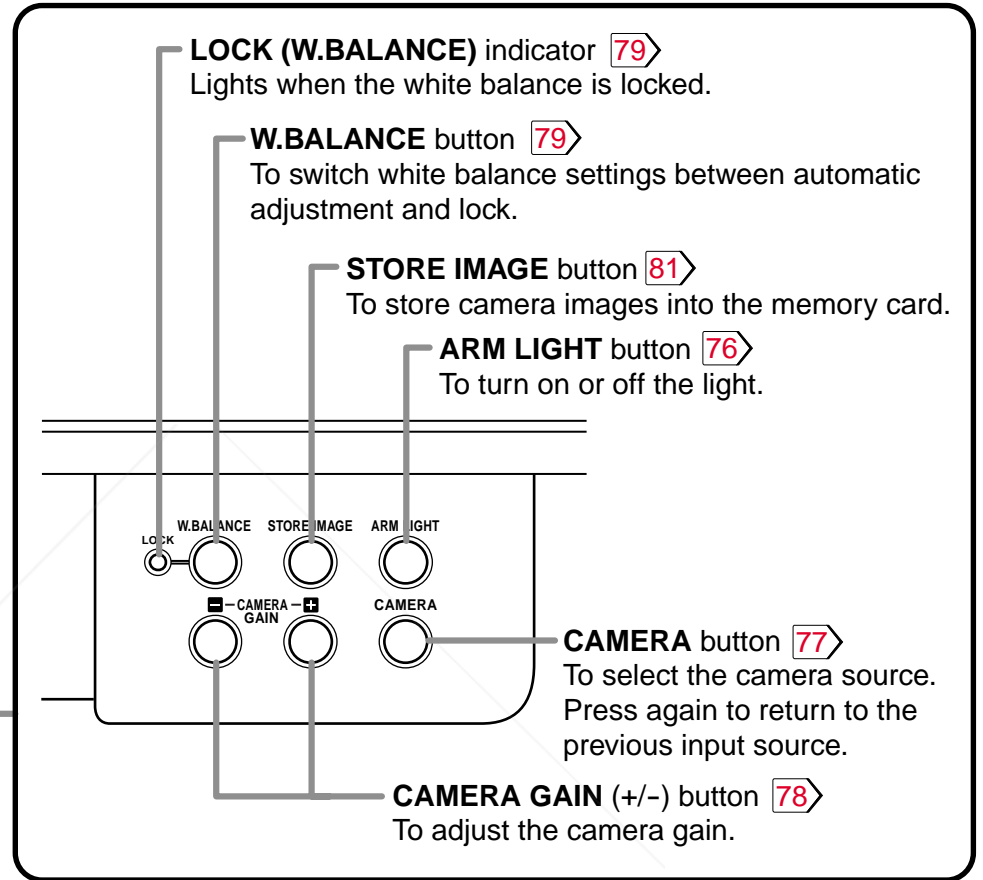
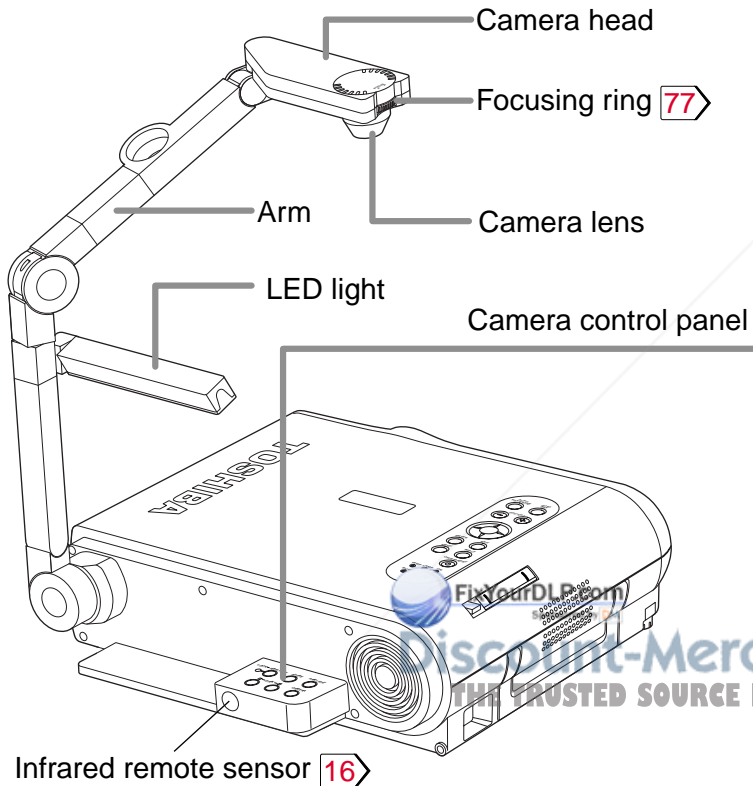

Before preparations
(stowed away)

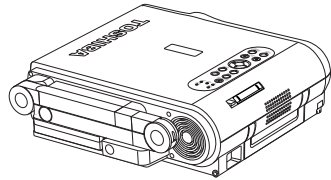

1) Raise up the arm.

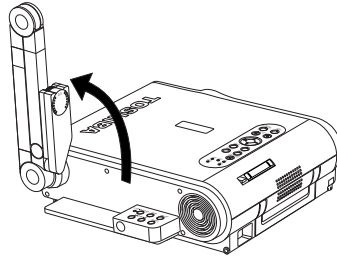

2) Stretch the arm.

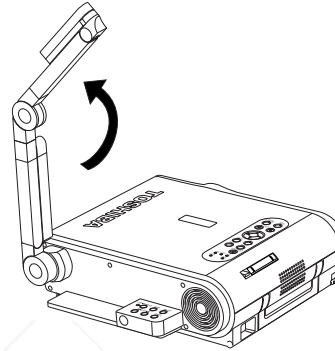

3) Turn the arm.

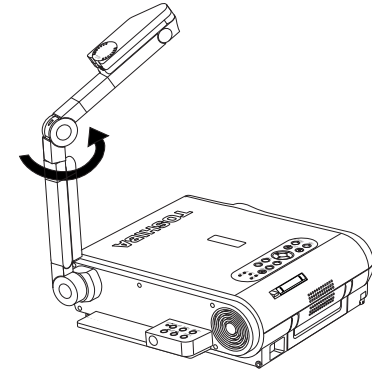

4) Open the camera head.

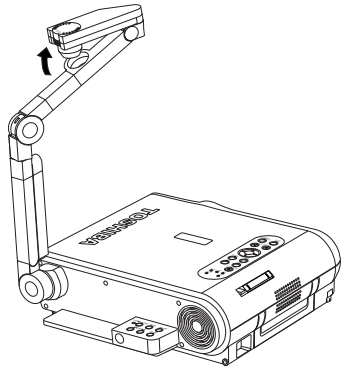

5) Turn the camera head.

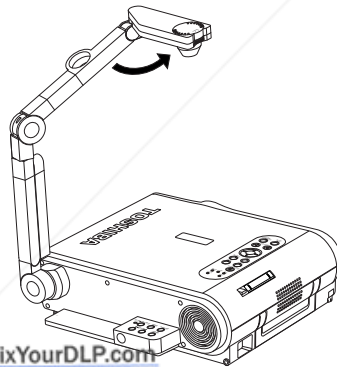

6) Pull up the light.

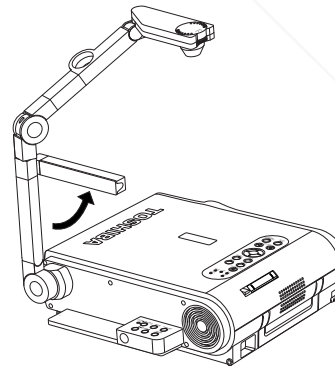

7) Turn the light.

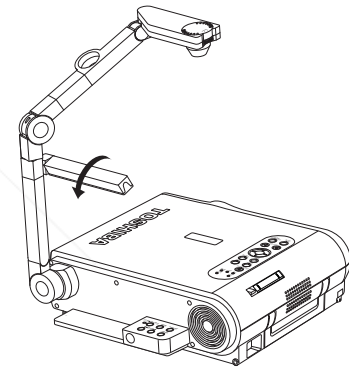

Discount-Merchant.com (800) 281-8860

THE TRUSTED SOURCE FOR PROJECTOR LAMPS AND ACCESSORIES

Notes

- Never give shocks or impacts to the camera or arm as this may cause malfunction.
- While raising up or turning the arm, the arm moves describing an arc, be careful not to hit your face or your body.

CAUTION

Do not look into the arm light while it is lit.

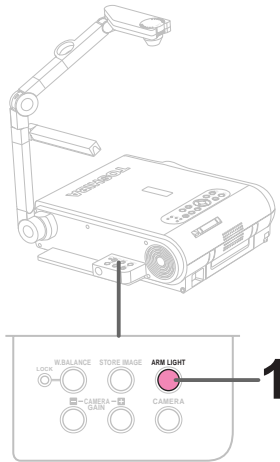

Camera control panel

Preparation

1 Project a picture on the screen as explained in the step "Projection on the screen". 28

1

ARM LIGHT



Press ARM LIGHT.

The light turns on.

2

Set a document to be projected.

Place the document (illustrations, etc.) onto or around the projector, and turn the camera head to the direction of the document.

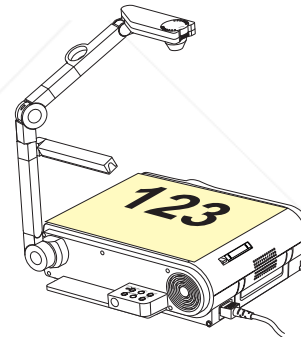

Images on the screen

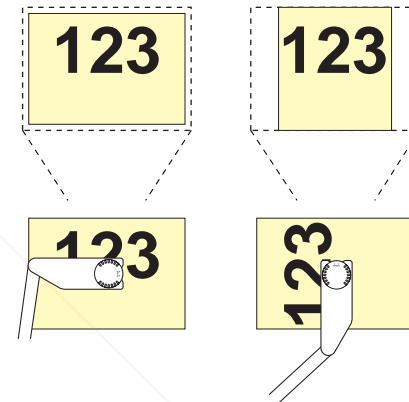

Setting direction

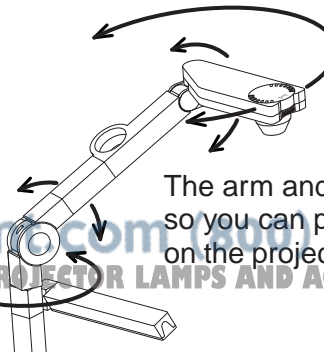

The arm and the camera head can be moved freely, so you can project the document if it is not placed on the projector.



Discount-Merch.com (800) 251-8800
THE TRUSTED SOURCE FOR PROJECTOR LAMPS AND ACCESSORIES

Document imaging camera

Remote control

Control panel
(Main unit side)

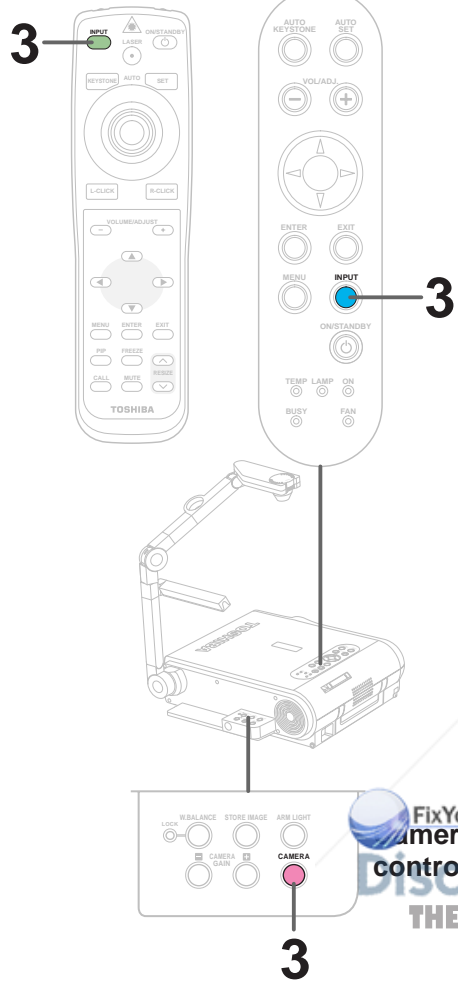

3

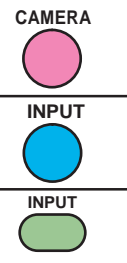

Press **CAMERA** to select the camera input mode.

- You can also select it by pressing **INPUT** on the remote control or on the main unit. Set the input source on the menu screen when selecting by the **INPUT** button. **54**
- The **CAMERA** button can be used regardless of the input setting.
- “Camera” is displayed when the picture switches to the document imaging camera’s picture.

4

Move the camera head to adjust the size of the picture.

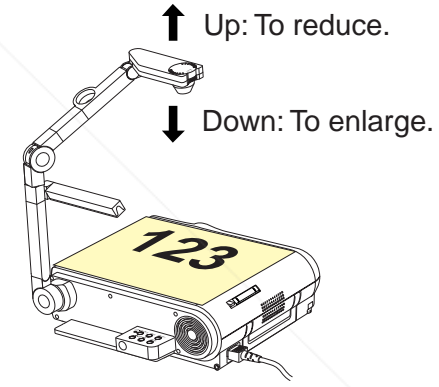

5

Focus on the picture by turning the focusing ring on the camera head.

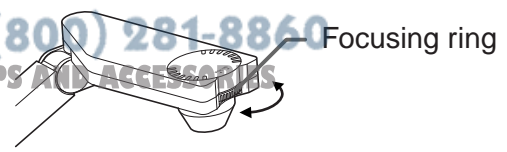

FixYourDLP.com
camera Sponsored by

control panel

Discount-Merchant.com (800) 281-8860
THE TRUSTED SOURCE FOR PROJECTOR LAMPS AND ACCESSORIES

Document
imaging camera

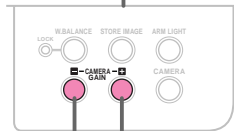
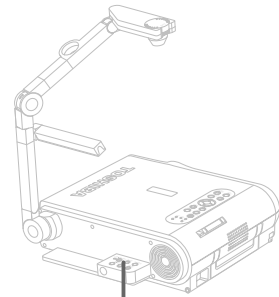

Camera control panel

6

6



Press **CAMERA GAIN (+/-)** to improve view of a camera subject which is too dark or vivid.

Notes

- You can adjust the “Sharpness” of the camera image on the menu screen. [54](#)
 - If the image flickers due to a fluorescent light in the room, either turn off the fluorescent light or set the “Shutter” from the menu screen. [54](#)
- Note that the image may still flicker due to the lighting, the document status, the image adjustment, etc., even if the “Shutter” setting is changed.

7

When finished, turn off the light and close it, and put back the arm.

Follow the steps of “Preparation of the document imaging camera” in reverse.

Notes

- Though this projector uses a 1.45 million pixel camera unit, the images projected on the screen are 1024 x 768 dot images. If the “Screen size” in the menu screen [54](#) is set to “Full”, the camera’s full image is compressed to 1024 x 768 dots. If “Thru” is selected, the 1024 x 768 dots at the center of the image are projected.
- The light turns off automatically when the arm is leaned.
- When the arm is not raised up, the camera source cannot be projected.
- In the camera input selected, audio signals are not output.

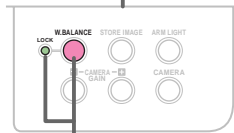
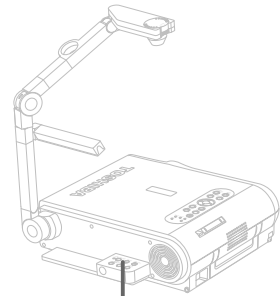

Camera control panel

2

Normally, this camera automatically adjusts the color balance to project the picture. If the adjustment is not sufficient, follow the steps below to lock the white balance.

1

Project a white paper and enlarge it to fill the screen.

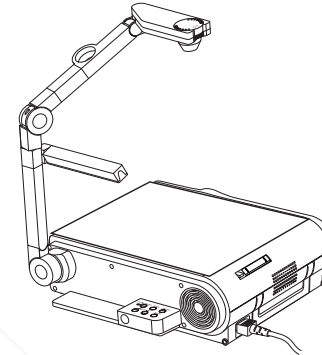

2

LOCK—W.BALANCE



Press **W.BALANCE** to turn the **LOCK** indicator on.

The white balance is locked.

To release the white balance, press **W.BALANCE** again to turn the **LOCK** indicator off.

Notes

- If you raise up the arm while the camera input is selected, the color of the picture may vary for an instant due to the automatic white balance adjustment. This is not a malfunction.
- If you put back the arm and raise it up while the white balance is locked (the **LOCK** indicator is lit), the projector releases the white balance.



Discount-Merchant.com (800) 281-8860
THE TRUSTED SOURCE FOR PROJECTOR LAMPS AND ACCESSORIES

Control panel
(Main unit side)

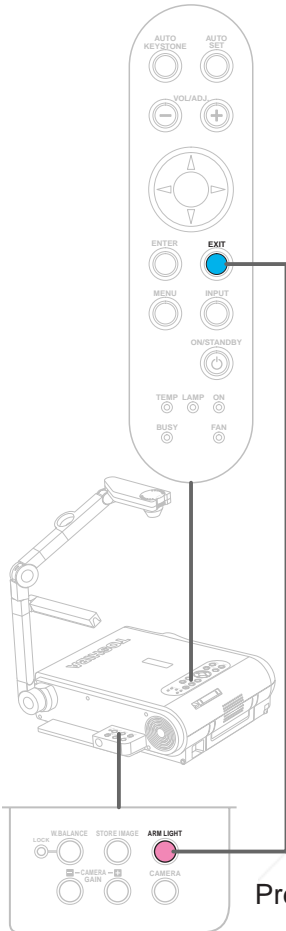

Camera control panel

Press both sides

FixYourDLP.com
Sponsored by

For the CCD image sensor used in the camera unit, in rare cases some of the pixels may be disturbed due to the influence of cosmic rays, etc. This disturbance may cause white spots to appear on the picture.

If white spots appear on the document camera image, use the procedure described below to correct it.

1

With the document camera operating, fully cover the camera lens with a piece of black paper or cloth.

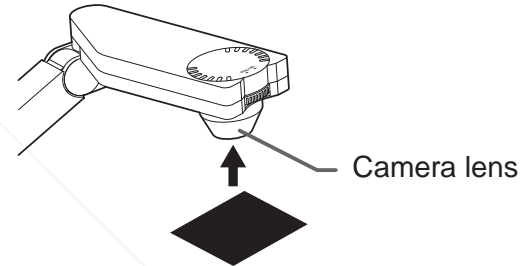

2

ARM LIGHT



+

EXIT



Press ARM LIGHT on the camera control panel and EXIT on the projector's control panel simultaneously.

You can not use the remote control buttons.

Note

Do not press **ARM LIGHT** and **EXIT** buttons simultaneously if the camera lens is not covered. Doing so will not only erase the white spot correction data already set but also result in parts that are displayed normally being corrected. Also be careful if the camera input mode is not selected.



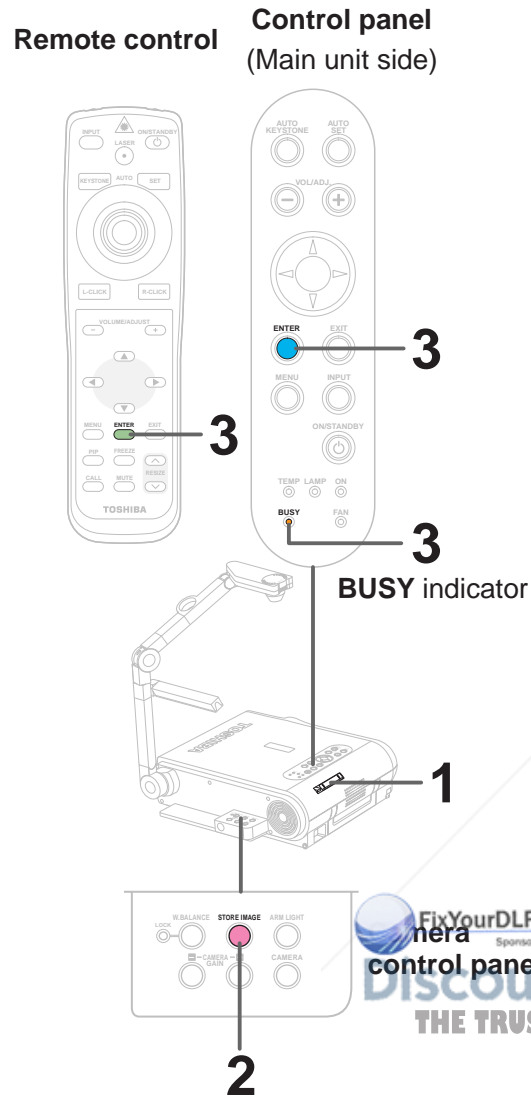

Discount-Merchant.com (800) 281-8860
THE TRUSTED SOURCE FOR PROJECTOR PARTS AND SUPPLIES



Document camera images can be stored on memory cards.

1 Insert a memory card into the card slot.  41
If the memory card "Input select mode" is set to "Auto.", the mode switches to the memory card input mode. If so, press the **CAMERA** button to return to the document imaging camera input mode.

2 STORE IMAGE  **Project the camera image you want to store on the cards, then press STORE IMAGE in the camera control panel.**
A message asking you to confirm that you want to store the image appears.

3   **Press ENTER. (To cancel, press EXIT.)**
The projector's BUSY indicator lights in orange.
Note that ejecting the memory card while the indicator is lit will damage the data.

The icon  appears when the memory card is in the storing mode.

Notes

- If the "Screen size" in the menu screen  54 is set to "Full", the camera's full image is compressed to 1280 x 960 dots before it is stored. If it is set to "Thru", only the 1024 x 768 dots at the center of the image are stored.
- The "Camera gain" and "Sharpness" settings are reflected on the images stored on memory cards; "Contrast" and "Brightness" settings are not.
- It is impossible to store resized or frozen images on memory cards.
- The image data is stored as JPEG format files in the memory card's "_tlpx" folder. If there is no "_tlpx" folder, one is created in the memory card's root directory. Stored files are named "Tlpx001.jpg" to "Tlpx999.jpg". If there is already a file named "Tlpx999.jpg" in the folder, no more images can be stored.
- The size of stored files depends on the content of the image. The number of files that can be stored on a memory card depends on the size of the files and the amount of free space of the memory card.
- Do not save the camera image when the memory card is in the write-protect mode. The memory card may not be accessed.

FixYourDLP.com
Sponsored by  **nera**
Discount-Multimedia.com (800) 251-8800
THE TRUSTED SOURCE FOR PROJECTOR LAMPS AND ACCESSORIES

Trouble indications

If there is some problem inside the projector, the indicators light up or blink.

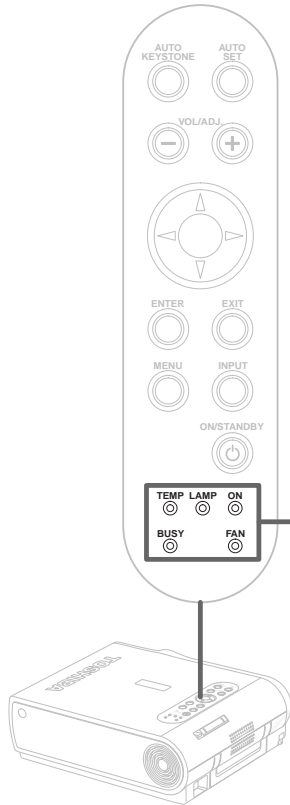

Control panel
(Main unit side)



Indicator

FixYourDLP.com
Sponsored by

Discount-Merchant.com (800) 231-8866
THE TRUSTED SOURCE FOR PROJECTOR LAMPS AND ACCESSORIES

| | |
|--|---------------------------------------------------------------------------------------------------------------------------------------------------------------------------------------------------------------------------------------------------------------------------------------------------------------------------------------------------------------------------------------------------------------------------------------------------------------------------------------------------------------------------------------------------------------|
| | <p>The power does not come on.</p> <p>→ Malfunction of the unit.</p> <ul style="list-style-type: none"> Unplug the power cord and call the dealer. |
| | <p>The lamp turns off or does not light up.</p> <p>→ The lamp's duration life is end, or malfunction of the unit.</p> <ul style="list-style-type: none"> Lamp's duration life is over, replace the lamp with a new one. 86 Unplug the power cord and call the dealer. |
| | <p>The power turns off or does not come on.</p> <p>→ The inside is too hot, or the projector has been working in an area of high temperature.</p> <ul style="list-style-type: none"> Place the projector correctly so the intake and exhaust fans' holes are not covered. Turn the projector off, and leave it for a while, and turn it on again. Clean the air filter. 83 <p>* The icon  appears before the power turned off.</p> |
| | <p>The power turns off or does not come on.</p> <p>→ Trouble with the cooling fan.</p> <ul style="list-style-type: none"> Unplug the power cord and call the dealer. <p>* The icon  appears before the power turned off.</p> |
| | <p>The power turns off or does not come on.</p> <p>→ The lamp cover is not properly attached.</p> <ul style="list-style-type: none"> Unplug the power cord and reattach the lamp cover. 87 <p>* The icon  appears before the power turned off.</p> |

Note

If abnormality occurs while operating, unplug the power cord.

CAUTION

If you use the projector mounted on the ceiling, ask the dealer to carry out the maintenance such as cleaning.

The filter inside the air filter cover is the part to shut out dusts or dregs.

Do not use the projector with the filter taken off.

We recommend you to clean the air filter frequently. (The cleaning period is once per about 50 hours).

1 Unplug the power cord.

2 **Take off the air filter cover.**
The filter is on the right side of the projector. Pull the bottom side of the cover upward to remove the filter cover.

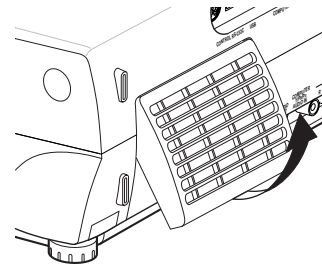

3 **Detach the air filter.**
Detach the air filter from the air filter cover. The air filter cover, air filter and filter frame can be disassembled.

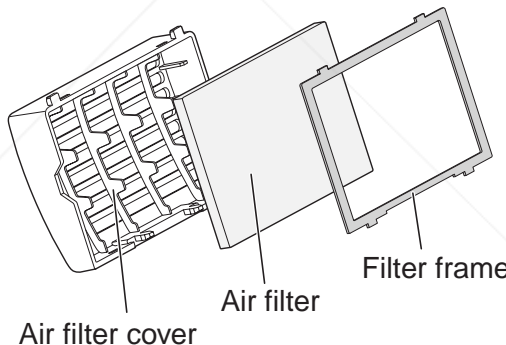

4 **Clean the air filter.**
Use a vacuum cleaner to carefully remove any dust and dirt from the air filter cover, air filter and filter frame. Be careful that the air filter is not sucked into the vacuum cleaner.

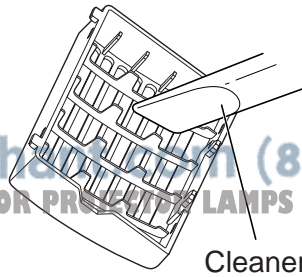

Discount-Merchandise.com (800) 201-8060
THE TRUSTED SOURCE FOR PROJECTOR LAMPS AND ACCESSORIES

Notes

- When the air filter is dusty, the ventilation is impaired. This causes the temperature inside the projector to rise, and may damage the unit.
- Attach the air filter cover firmly after the cleaning. If it is not set correctly, the dusts will enter and they will be projected and overlapped on the picture.
- If you wash the air filter with water, be sure to let it dry fully before reinstalling it. Using it damp will result in malfunction.
- If the air filter is damaged, contact your store of purchase and replace it with a new one. Using a damaged air filter will cause dust or dirt to get inside the projector and onto the images.

5

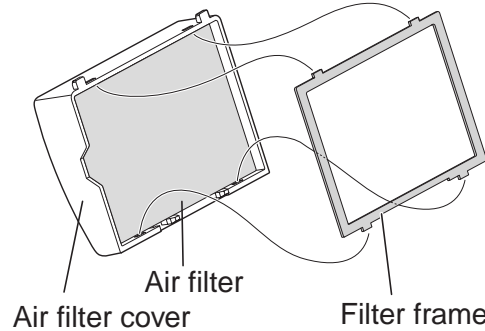

Assemble the air filter.

Place the air filter in the air filter cover, then insert the four tabs on the filter frame into the holes in the air filter cover.

6

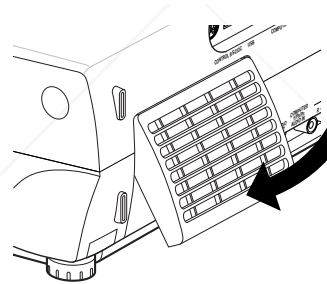

Mount the air filter cover.

Insert the top of the air filter cover into the projector first, then press on the bottom side to install it.

CAUTION

If you use the projector mounted on the ceiling, ask the dealer to carry out the maintenance such as cleaning.

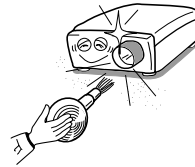

Cleaning the lens

Use a blower or a lens cleaner to clean the lens. Never rub or tap the lens with a hard object as the lens surface is fragile.

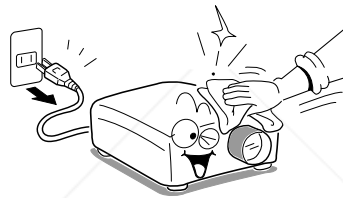

Cleaning the main unit

- Pull out the power cord before cleaning.
- Use a soft cloth to wipe off stains from the surface.
- To remove difficult stains, use a soft cloth slightly moistened with a weak solution of synthetic detergent and water, and finish with a soft, dry cloth.

Replacing the intake, exhaust fans and air filter

To maintain the efficiency of the projector, replace the intake and exhaust fans about every two to three years. Ask the dealer for the replacement.



Discount-Merchant.com (800) 281-8860
THE TRUSTED SOURCE FOR PROJECTOR LAMPS AND ACCESSORIES

Lamp replacement

The lamp will eventually begin to project dark or dull pictures and finally will not light up. (Lamp's life length depends on the use condition.) In such a case, replace the lamp with new one.

CAUTION

- If you use the projector mounted on the ceiling, ask the dealer to carry out the maintenance such as cleaning or replacement of the lamp.
- When replacing, always use lamp "TLPLX10" (sold separately). For detail, refer to the lamp instruction.
- If you have been using the projector, the lamp will be very hot, and may cause burn injuries. Wait for the lamp to cool (for longer than 1 hour) before replacing it.
- If the lamp should break, please handle with care to avoid injury due to broken pieces and contact your dealer for repair service.

1 Unplug the power cord.

2 Wait until the lamp gets cold enough.

3 Take off the lamp cover on the bottom panel.
Loosen two screws, and pull off the lamp cover.

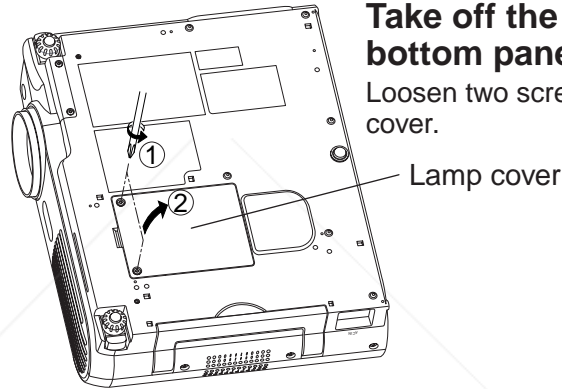

4 Pull out the lamp.
Loosen the two fixing screws, and lift up the handle to pull out the lamp.

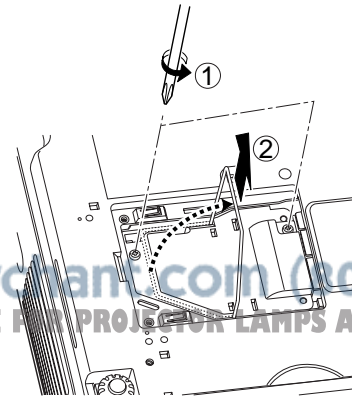

Discount-Merchant.com (800) 281-8860
THE TRUSTED SOURCE FOR PROJECTOR LAMPS AND ACCESSORIES

Notes

- When the **CALL** button is pressed, the “Lamp time” (the approximate amount of time the lamp has been used) is displayed. **38**
- The lamp should be replaced if the total working time exceeds about 1,000 hours.

When the “Lamp time” is displayed 1000 hours, the icon  and a message appear. They will disappear when you do some operation.

- Attach the lamp cover firmly after replacing the lamp. If it is not set correctly, the power will not turn on.
- Use a new lamp when replacing it.
- The lamp is made of glass and is very fragile. Do not touch the lamp with your bare hands and do not jolt or damage it. Do not use an exhausted lamp.
- Dispose the exhausted lamp as toxic wastes.

5 Load a new lamp.

Slide until it hits the bottom and tighten the two fixed screws.

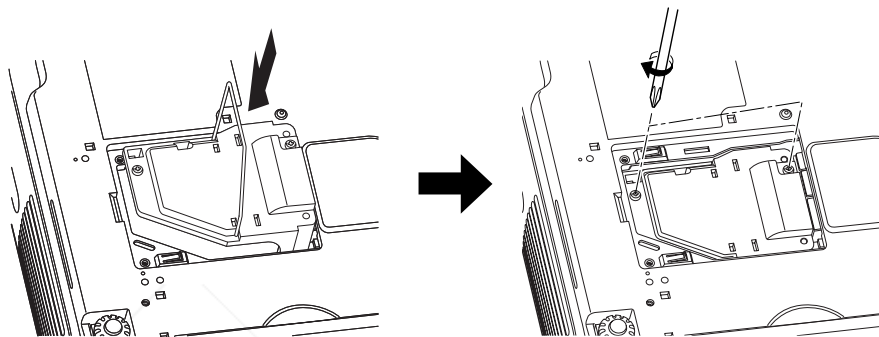

6 Attach the lamp cover.

Slide the cover in place and tighten two screws.

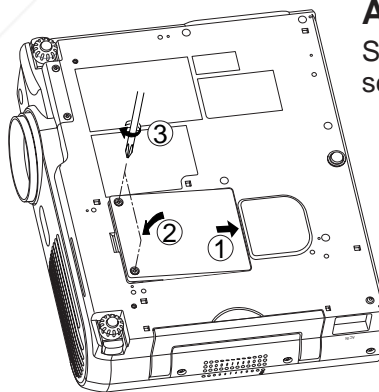

7 Reset the lamp timer.

Refer to the lamp instructions for resetting.

Before calling service personal

Check the following points before asking for support service. Refer also to “Trouble indications”. [82](#)

| Symptom | Cause | Correction | Page |
|--------------------------------------------------------------|------------------------------------------------------------------------------------------------------------------------------------------|------------------------------------------------------------------------------------|--------------------|
| The power does not come on. | • The power cord is disconnected. | Firmly plug in the power cord. | 19 |
| | • The lamp cover is not attached correctly. | Attach the cover correctly. | 87 |
| The power turns off while using the projector. | • The ambient temperature of the projection room is too high. | Lower the ambient temperature of the projection room, and turn the power on. | 82 |
| No image appears. | • The lens cover is on. | Take off the lens cover. | 19 |
| | • The wrong input is selected. | Select the input source correctly. | 29 |
| | • The muting mode is on. | Press MUTE to restore the picture. | 34 |
| | • The “Brightness” adjustment is at its darkest. | Make the “Brightness” adjustment. | 48 |
| | • The source is not correctly connected to the projector. | Connect the source correctly to the projector. | 22 |
| No sound is heard. | • The wrong input is selected. | Select the input source correctly. | 29 |
| | • The muting mode is on. | Press MUTE to restore the sound. | 34 |
| | • The sound volume is at the minimum. | Adjust the sound volume. | 12 |
| | • The source is not correctly connected to the projector. | Connect the source correctly to the projector. | 22 |
| Desired input source cannot be selected by the INPUT button. | • Input is not set so that it can be selected with the INPUT button. By default, only the RGB1 and video input modes can be selected. | Set from the menu screen so that the source can be selected with the INPUT button. | 48 |
| RGB1 input or Y/Pb/Pr input colors are not right. | • The COMPUTER IN 1 connector’s input setting is wrong. | At the menu screen, set for the proper input signal type. | 48 |
| RGB2 input image does not appear. | • The COMPUTER IN 2 connector’s input setting is wrong. | At the menu screen, set for the proper input signal type. | 48 |
| | • The signal cable type is wrong. | Use a proper signal cable. | 23 |
| Digital RGB input image does not appear. | • The COMPUTER IN 2 connector’s input setting is wrong. | At the menu screen, set for the proper input signal type. | 48 |
| | • The signal cable type is wrong. | Use a proper signal cable. | 23 |
| The image is blurred. Focusing is uneven. | • The lens is dirty. | Clean the lens with a blower or lens cleaner, etc. | 85 |
| | • The picture is out of focus. | Focus the picture. | 30 |
| | • The projection distance is not appropriate. | Adjust the distance properly. | 18 |
| | • The projecting light is not hitting the screen squarely. | Adjust the projecting direction so that the light hits the screen squarely. | 18 |
| | • The “Brightness”, “Contrast”, “Sharpness” or “Phase” adjustments are not correct. | Make the “Picture” adjustments. | 54 |
| The picture is dim. | • The “Brightness” or “Contrast” adjustments are not correct. | Make the “Picture” adjustments. | 54 |
| | • The lamp life is ending. | Replace the lamp. | 86 |

Before calling service personal (continued)

| Symptom | Cause | Correction | Page |
|--------------------------------------------------------------------------------------|---------------------------------------------------------------------------------------|--------------------------------------------------------------------------------|------|
| The color is faint. The tint is not good. | • The "Color", "Tint", "R-Level", "G-Level" or "B-Level" adjustments are not correct. | Make the "Picture" adjustments. | 54 |
| | • The lamp life is ending. | Replace the lamp. | 85 |
| The remote control does not work. | • The remote control is not facing the remote sensor. | Face the remote control transmitter toward the remote sensor on the projector. | 16 |
| | • The remote control is too far. | Operate within about 5 meters. | 16 |
| | • There is an obstruction between the remote control and the remote sensor. | Remove the obstacle. | - |
| | • The batteries are exhausted. | Replace the batteries. | 15 |
| Image data on a memory card cannot be displayed. | • No memory card is inserted. | Insert the memory card properly. | 41 |
| | • A different type of memory card is inserted. | Replace with a compatible memory card. | 40 |
| | • There are no JPEG files on the memory card. | Check using the thumbnail display. | 42 |
| | • The JPEG files have been created with an incompatible compression format. | Convert JPEG files to a compatible compression format. | - |
| Mouse function cannot be used from the remote control unit. | • The USB cable is not properly connected. | Connect the USB cable properly. | 39 |
| | • The computer or OS is not compatible. | The remote control mouse function is not available. | - |
| | • The batteries are exhausted. | Replace the batteries. | 15 |
| Document camera image is blurry. | • The lens is dirty. | Clean the lens with a blower or lens cleaner, etc. | 85 |
| | • The picture is out of focus. | Focus the picture by turning the focus ring. | 77 |
| | • The light is not on. | Turn on the light. | 76 |
| Document camera image flickers. | • Image is being affected by fluorescent light in the room. | Set the shutter speed on the menu screen. | 54 |
| Document camera image movement is awkward. | • The image's number of frames is low. This is not a malfunction. | | |
| Horizontal stripes appear when document projected with the document camera is moved. | • The image's number of frames is low. This is not a malfunction. | | |



COMPUTER IN 1 MONITOR OUT

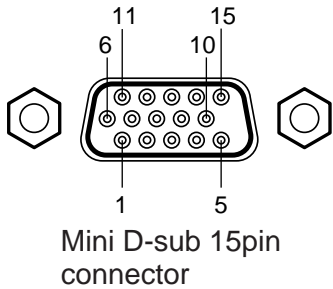

Input signal
 Analog R, G, B signal: 0.7V(p-p) 75Ω
 Horizontal sync signal:
 TTL level (positive/negative polarity)
 Vertical sync signal:
 TTL level (positive/negative polarity)
 Y signal: 1.0V(p-p) 75Ω
 P_B, P_R signal: 0.7V(p-p) 75Ω

COMPUTER IN 2

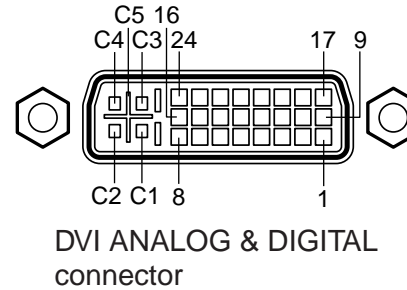

Analog input signal
 Analog R, G, B signal: 0.7V(p-p) 75Ω
 Horizontal sync signal:
 TTL level (positive/negative polarity)
 Vertical sync signal:
 TTL level (positive/negative polarity)

| Pin No. | Description | |
|---------|------------------------|-------------------------------------------|
| | RGB input | Y/P _B /P _R input |
| 1 | Video signal (Red) | Color difference signal (P _R) |
| 2 | Video signal (Green) | Luminance signal (Y) |
| 3 | Video signal (Blue) | Color difference signal (P _B) |
| 4 | GND | * |
| 5 | GND | * |
| 6 | GND (Red) | GND (P _R) |
| 7 | GND (Green) | GND (Y) |
| 8 | GND (Blue) | GND (P _B) |
| 9 | N.C | * |
| 10 | GND | * |
| 11 | GND | * |
| 12 | DDC2B data | * |
| 13 | Horizontal sync signal | |
| 14 | Vertical sync signal | |
| 15 | DDC2B clock | |

| Pin No. | Description |
|---------|-----------------------------|
| 1 | T.M.D.S. data 2 - |
| 2 | T.M.D.S. data 2 + |
| 3 | T.M.D.S. data 2/4 shield |
| 4 | T.M.D.S. data 4 - |
| 5 | T.M.D.S. data 4 + |
| 6 | DDC clock |
| 7 | DDC data |
| 8 | Analog vertical sync signal |
| 9 | T.M.D.S. data 1 - |
| 10 | T.M.D.S. data 1 + |
| 11 | T.M.D.S. data 1/3 shield |
| 12 | T.M.D.S. data 3 - |
| 13 | T.M.D.S. data 3 + |
| 14 | +5V power |
| 15 | GND (+5V, H Sync & V Sync) |

| Pin No. | Description |
|---------|-------------------------------|
| 16 | Hot plug detection |
| 17 | T.M.D.S. data 0 - |
| 18 | T.M.D.S. data 0 + |
| 19 | T.M.D.S. data 0/5 shield |
| 20 | T.M.D.S. data 5 - |
| 21 | T.M.D.S. data 5 + |
| 22 | T.M.D.S. clock shield |
| 23 | T.M.D.S. clock + |
| 24 | T.M.D.S. clock - |
| C1 | Analog Video signal (Red) |
| C2 | Analog Video signal (Green) |
| C3 | Analog Video signal (Blue) |
| C4 | Analog horizontal sync signal |
| C5 | Analog GND (R,G & B) |



Discount-Merchant.com (800) 281-8860
 THE TRUSTED SOURCE FOR PROJECTOR LAMPS AND ACCESSORIES

* : Do not connect anything.

Applicable RGB signal

The unit is applicable to the following signals. However, some computers may have different timings than those in the chart. Make the necessary adjustments if the picture has flickers or is blurred.

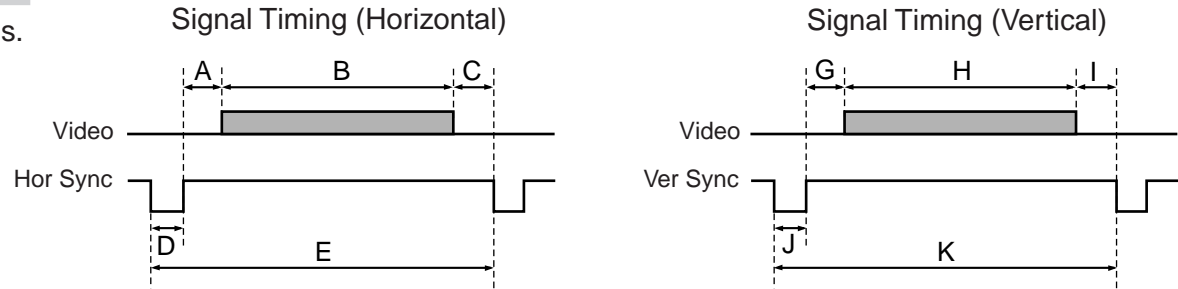

Timing chart

| Mode | Resolution | A (Pixels) | B (Pixels) | C (Pixels) | D (Pixels) | E (Pixels) | fh (kHz) | fv (Hz) | Clock (MHz) | G (Lines) | H (Lines) | I (Lines) | J (Lines) | K (Lines) |
|--------------|------------|------------|------------|------------|------------|------------|----------|---------|-------------|-----------|-----------|-----------|-----------|-----------|
| TEXT70 | 640 x 350 | 50 | 640 | 14 | 96 | 800 | 31.469 | 70.086 | 25.175 | 59 | 350 | 38 | 2 | 449 |
| TEXT70 | 640 x 400 | 50 | 640 | 14 | 96 | 800 | 31.469 | 70.086 | 25.175 | 34 | 400 | 13 | 2 | 449 |
| TEXT85 | 640 x 350 | 96 | 640 | 32 | 64 | 832 | 37.861 | 85.080 | 31.500 | 60 | 350 | 32 | 3 | 445 |
| TEXT85 | 640 x 400 | 96 | 640 | 32 | 64 | 832 | 37.861 | 85.080 | 31.500 | 41 | 400 | 1 | 3 | 445 |
| NEC PC98 24k | 640 x 400 | 85 | 640 | 59 | 64 | 848 | 24.820 | 55.900 | 21.047 | 25 | 400 | 11 | 8 | 444 |
| VGA60 | 640 x 480 | 48 | 640 | 16 | 96 | 800 | 31.469 | 59.940 | 25.175 | 33 | 480 | 10 | 2 | 525 |
| VGA72 | 640 x 480 | 128 | 640 | 24 | 40 | 832 | 37.861 | 72.809 | 31.500 | 28 | 480 | 9 | 3 | 520 |
| VGA75 | 640 x 480 | 120 | 640 | 16 | 64 | 840 | 37.500 | 75.000 | 31.500 | 16 | 480 | 1 | 3 | 500 |
| VGA85 | 640 x 480 | 80 | 640 | 56 | 56 | 832 | 43.269 | 85.008 | 36.000 | 25 | 480 | 1 | 3 | 509 |
| MAC13" | 640 x 480 | 96 | 640 | 64 | 64 | 864 | 35.000 | 66.667 | 30.240 | 39 | 480 | 3 | 3 | 525 |
| SVGA56 | 800 x 600 | 128 | 800 | 24 | 72 | 1024 | 35.156 | 56.250 | 36.000 | 22 | 600 | 1 | 2 | 625 |
| SVGA60 | 800 x 600 | 88 | 800 | 40 | 128 | 1056 | 37.879 | 60.317 | 40.000 | 23 | 600 | 1 | 4 | 628 |
| SVGA72 | 800 x 600 | 64 | 800 | 56 | 120 | 1040 | 48.077 | 72.188 | 50.000 | 23 | 600 | 37 | 6 | 666 |
| SVGA75 | 800 x 600 | 160 | 800 | 16 | 80 | 1056 | 46.875 | 75.000 | 49.500 | 21 | 600 | 1 | 3 | 625 |
| SVGA85 | 800 x 600 | 152 | 800 | 32 | 64 | 1048 | 53.674 | 85.061 | 56.250 | 27 | 600 | 1 | 3 | 631 |
| MAC16" | 832 x 624 | 216 | 832 | 40 | 64 | 1152 | 49.725 | 74.550 | 57.283 | 39 | 632 | 1 | 3 | 667 |
| XGA43i | 1024 x 768 | 56 | 1024 | 8 | 176 | 1264 | 35.522 | 43.479 | 44.900 | 20 | 768 | 0 | 4 | 817 |
| XGA60 | 1024 x 768 | 160 | 1024 | 24 | 136 | 1344 | 48.363 | 60.004 | 65.000 | 29 | 768 | 3 | 6 | 806 |
| XGA70 | 1024 x 768 | 144 | 1024 | 24 | 136 | 1328 | 56.476 | 70.069 | 75.000 | 29 | 768 | 3 | 6 | 806 |
| XGA75 | 1024 x 768 | 176 | 1024 | 16 | 96 | 1312 | 60.023 | 75.029 | 78.750 | 28 | 768 | 1 | 3 | 800 |
| XGA85 | 1024 x 768 | 208 | 1024 | 48 | 96 | 1376 | 68.677 | 84.997 | 94.500 | 36 | 768 | 1 | 3 | 808 |
| MAC19" | 1024 x 768 | 180 | 1024 | 20 | 96 | 1320 | 60.197 | 74.872 | 73.200 | 30 | 768 | 3 | 3 | 804 |

Timing chart (Continued)

| Mode | Resolution | A (Pixels) | B (Pixels) | C (Pixels) | D (Pixels) | E (Pixels) | fh (kHz) | fv (Hz) | Clock (MHz) | G (Lines) | H (Lines) | I (Lines) | J (Lines) | K (Lines) |
|---------------------|-------------|---------------|---------------|---------------|---------------|---------------|-------------|------------|----------------|--------------|--------------|--------------|--------------|--------------|
| *SXGA1152x864 75Hz | 1152 x 864 | 256 | 1152 | 64 | 128 | 1600 | 67.500 | 75.000 | 108.000 | 32 | 864 | 1 | 3 | 900 |
| *SXGA1280x960 60Hz | 1280 x 960 | 312 | 1280 | 96 | 112 | 1800 | 60.000 | 60.000 | 108.000 | 36 | 960 | 1 | 3 | 1000 |
| *SXGA1280x960 85Hz | 1280 x 960 | 224 | 1280 | 64 | 160 | 1728 | 85.938 | 85.002 | 148.500 | 47 | 960 | 1 | 3 | 1011 |
| *SXGA1280x1024 60Hz | 1280 x 1024 | 248 | 1280 | 48 | 112 | 1688 | 63.981 | 60.020 | 108.000 | 38 | 1024 | 1 | 3 | 1066 |
| *SXGA1280x1024 75Hz | 1280 x 1024 | 248 | 1280 | 16 | 144 | 1688 | 79.976 | 75.025 | 135.000 | 38 | 1024 | 1 | 3 | 1066 |
| *SXGA1280x1024 85Hz | 1280 x 1024 | 224 | 1280 | 64 | 160 | 1728 | 91.146 | 85.024 | 157.500 | 44 | 1024 | 1 | 3 | 1072 |
| *UXGA60 | 1600 x 1200 | 304 | 1600 | 64 | 192 | 2160 | 75.000 | 60.000 | 162.000 | 46 | 1200 | 1 | 3 | 1250 |
| *UXGA65 | 1600 x 1200 | 304 | 1600 | 64 | 192 | 2160 | 81.250 | 65.000 | 175.500 | 46 | 1200 | 1 | 3 | 1250 |
| *UXGA70 | 1600 x 1200 | 304 | 1600 | 64 | 192 | 2160 | 87.500 | 70.000 | 189.000 | 46 | 1200 | 1 | 3 | 1250 |
| *UXGA75 | 1600 x 1200 | 304 | 1600 | 64 | 192 | 2160 | 93.750 | 75.000 | 202.500 | 46 | 1200 | 1 | 3 | 1250 |

Notes

- Signal sources marked “*” are displayed in compressed format, so some of their data may be missing or their picture quality may be degraded.
- With analog RGB input, if the signal source’s dot clock frequency exceeds 140 MHz, not all of the pixel signals can be sampled.
- For digital RGB inputs, the projector is not compatible with signal sources whose dot clock frequency exceeds 112 MHz.

The compatible video signal

| Mode | fh (kHz) | fv (Hz) | fsc (MHz) |
|----------|----------|---------|--------------|
| NTSC | 15.73 | 60 | 3.58 |
| PAL | 15.63 | 50 | 4.43 |
| SECAM | 15.63 | 50 | 4.25 or 4.41 |
| PAL-M | 15.73 | 60 | 3.58 |
| PAL-N | 15.63 | 50 | 3.58 |
| PAL-60 | 15.73 | 60 | 4.43 |
| NTSC4.43 | 15.73 | 60 | 4.43 |

The compatible component signal (Y/Pb/Pr)

| Mode | fh (kHz) | fv (Hz) |
|-------|----------|---------|
| 480i | 15.73 | 59.94 |
| 480p | 31.47 | 59.94 |
| 720p | 45.00 | 60.00 |
| 1080i | 33.75 | 60.00 |

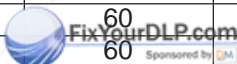

Discount-Merchant.com (800) 281-8860
 THE TRUSTED SOURCE FOR PROJECTOR LAMPS AND ACCESSORIES

Controlling the projector by using RS-232C

You can also control the projector by entering the command from a computer via RS-232C.

Signal assignment of RS-232C

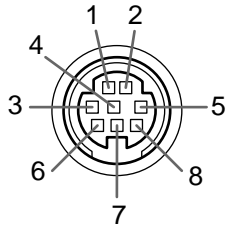

CONTROL RS-232C
Mini DIN 8-pin

| Pin No. | Signal | Description |
|---------|--------|-----------------|
| 1 | RXD | Receiving data |
| 2 | CTS | Consent to send |
| 3 | DSR | Data set ready |
| 4 | GND | Signal ground |
| 5 | RTS | Request to send |
| 6 | N.C | No connection |
| 7 | TXD | Sending data |
| 8 | N.C | No connection |

Interface format

| | | |
|---|----------------------|------------------------------------------------------------------------------------------------------|
| 1 | Communication method | RS-232C 9600 bps, No parity, Data length: 8 bit, Stop bit: 1 bit |
| 2 | Communication format | STX (02h) Command (3Byte) ETX (03h) One command only can be used in one communication. |
| 3 | Data format | Command shall be composed of alphanumeric characters of ASCII description. Use only capital letters. |
| 4 | Return value | Acknowledge ACK (06h) Not Acknowledge NAK (15h) |

Command list

| Classification | Items/Status | Selection Command | Adjustment Command | Analog RGB1 Analog RGB2 | Digital RGB | Video S-video | Y/PB/PR | Memory Card | Document Imaging Camera |
|----------------------------------------|------------------------------------------|-------------------|--------------------|----------------------------|-------------|------------------|---------|-------------|-------------------------|
| Power | On | PON | – | ○ | ○ | ○ | ○ | ○ | ○ |
| | Off (with confirmation message) | POF | – | ○ | ○ | ○ | ○ | ○ | ○ |
| | Shut Down (without confirmation message) | PSD | – | ○ | ○ | ○ | ○ | ○ | ○ |
| Normal (RS-232C Condition Display Off) | | DOF | – | ○ | ○ | ○ | ○ | ○ | ○ |
| Picture | Contrast | VCN | ○ | ○ | ○ | ○ | ○ | ○ | ○ |
| | Brightness | VBR | ○ | ○ | ○ | ○ | ○ | ○ | ○ |
| | Phase | PPH | ○ | ○ | – | – | – | – | – |
| | Frequency | PCK | ○ | ○ | – | – | – | – | – |
| | Color | VCL | ○ | – | – | ○ | ○ | – | – |
| | Tint | VTN | ○ | – | – | ○ *1 | ○ *2 | – | – |
| | Sharpness | VSH | ○ | – | – | ○ | ○ *2 | – | – |
| | Shutter | CS0 | – | – | – | – | – | – | ○ |
| | 60 Hz | CS1 | – | – | – | – | – | ○ | |

Notes

- When commands are transmitted serially, keep more than 100 ms intervals between the commands.
- Adjustment commands include "ARG" (increase adjustment value) and "ALF" (decrease adjustment value). For usable items (marked "O"), send after the selection command.
- The "O" marks in the input source columns indicate that that command can be used. *1 Not possible for PAL/SECAM. *2 Not possible for 480i mode.

Continued

Controlling the projector by using RS-232C (continued)

| Classification | Items/Status | Selection Command | Adjustment Command | Analog RGB1 Analog RGB2 | Digital RGB | Video S-video | Y/PB/PR | Memory Card | Document Imaging Camera |
|----------------|-------------------|-------------------|--------------------|----------------------------|-------------|---------------|---------|-------------|-------------------------|
| Picture | Position | H-position | PHP | ○ | ○ | — | — | — | — |
| | | V-position | PVP | ○ | ○ | — | — | — | — |
| | Picture mode | Bright | MVB | — | ○ | ○ | — | — | — |
| | | True color | MVP | — | ○ | ○ | — | — | — |
| | Video mode | Auto. | KV0 | — | — | — | ○ | — | — |
| | | NTSC | KV1 | — | — | — | ○ | — | — |
| | | PAL | KV2 | — | — | — | ○ | — | — |
| | | SECAM | KV3 | — | — | — | ○ | — | — |
| | | PAL-N | KV4 | — | — | — | ○ | — | — |
| | | PAL-M | KV5 | — | — | — | ○ | — | — |
| | | PAL60 | KV6 | — | — | — | ○ | — | — |
| | | NTSC4.43 | KV7 | — | — | — | ○ | — | — |
| | | Signal format | Auto. | SG0 | — | — | — | — | ○ |
| | 480i | | SG1 | — | — | — | — | ○ | — |
| | 480p | | SG2 | — | — | — | — | ○ | — |
| | 720p | | SG3 | — | — | — | — | ○ | — |
| | 1080i | | SG4 | — | — | — | — | ○ | — |
| | Input Select mode | Manual | J10 | — | — | — | — | — | ○ |
| | | Auto. | J11 | — | — | — | — | — | ○ |
| | Auto. demo | Off | JD0 | — | — | — | — | — | ○ |
| | | On | JD1 | — | — | — | — | — | ○ |
| | Slide show | Manual | JS0 | — | — | — | — | — | ○ |
| | | Auto. | JS1 | — | — | — | — | — | ○ |
| | Interval | 10 sec. | JT0 | — | — | — | — | — | ○ |
| | | 30 sec. | JT1 | — | — | — | — | — | ○ |
| | | 3 min. | JT2 | — | — | — | — | — | ○ |
| | | 10 min. | JT3 | — | — | — | — | — | ○ |
| | Screen size | Full | MSF | — | ○ | ○ | ○ | ○ | ○ |
| | | Thru | MST | — | ○ | ○ | ○ | ○ | ○ |
| | | Wide | MSW | — | ○ | ○ | ○ | ○ | ○ |
| | Level | R-level | VLR | ○ | ○ | ○ | ○ | ○ | ○ |
| | | G-level | VLG | ○ | ○ | ○ | ○ | ○ | ○ |
| B-level | | VLB | ○ | ○ | ○ | ○ | ○ | ○ | |

Controlling the projector by using RS-232C (continued)

| Classification | Items/Status | | Selection Command | Adjustment Command | Analog RGB1 Analog RGB2 | Digital RGB | Video S-video | Y/PB/PR | Memory Card | Document Imaging Camera |
|----------------|----------------------------------|----------------------|-------------------|--------------------|----------------------------|-------------|---------------|---------|-------------|-------------------------|
| Audio | Speaker output | On | AS1 | — | ○ | ○ | ○ | ○ | — | — |
| | | Off | AS0 | — | ○ | ○ | ○ | ○ | — | — |
| | Channel select (RCA) | L+R | APA | — | — | — | ○ | — | — | — |
| | | L | APL | — | — | — | ○ | — | — | — |
| | | R | APR | — | — | — | ○ | — | — | — |
| | Loudness (RCA) | Off | LR0 | — | — | — | ○ | — | — | — |
| | | On | LR1 | — | — | — | ○ | — | — | — |
| | Channel select (Mini) | L+R | AMA | — | ○ | ○ | — | ○ | — | — |
| | | L | AML | — | ○ | ○ | — | ○ | — | — |
| | | R | AMR | — | ○ | ○ | — | ○ | — | — |
| | Loudness (Mini) | Off | LM0 | — | ○ | ○ | — | ○ | — | — |
| | | On | LM1 | — | ○ | ○ | — | ○ | — | — |
| Keystone | Keystone | | PKS | ○ | ○ | ○ | ○ | ○ | ○ | ○ |
| | Horizontal reference value reset | | PKR | — | ○ | ○ | ○ | ○ | ○ | ○ |
| Display | Language | English | LEN | — | ○ | ○ | ○ | ○ | ○ | ○ |
| | | French | LFR | — | ○ | ○ | ○ | ○ | ○ | ○ |
| | | German | LGR | — | ○ | ○ | ○ | ○ | ○ | ○ |
| | | Italian | LIT | — | ○ | ○ | ○ | ○ | ○ | ○ |
| | | Spanish | LSP | — | ○ | ○ | ○ | ○ | ○ | ○ |
| | | Portuguese | LPO | — | ○ | ○ | ○ | ○ | ○ | ○ |
| | | Japanese | LJP | — | ○ | ○ | ○ | ○ | ○ | ○ |
| | | Chinese(Simplified) | LPK | — | ○ | ○ | ○ | ○ | ○ | ○ |
| | | Chinese(Traditional) | LKT | — | ○ | ○ | ○ | ○ | ○ | ○ |
| | | Korean | LKK | — | ○ | ○ | ○ | ○ | ○ | ○ |
| | No signal background | Logo | BG0 | — | ○ | ○ | ○ | ○ | ○ | ○ |
| | | Blue background | BG1 | — | ○ | ○ | ○ | ○ | ○ | ○ |
| | | Non | BG2 | — | ○ | ○ | ○ | ○ | ○ | ○ |
| | Icon | On | MO0 | — | ○ | ○ | ○ | ○ | ○ | ○ |
| | | Off | MO1 | — | ○ | ○ | ○ | ○ | ○ | ○ |
| | Menu position | Upper left | MP1 | — | ○ | ○ | ○ | ○ | ○ | ○ |
| | | Lower left | MP2 | — | ○ | ○ | ○ | ○ | ○ | ○ |
| | | Upper right | MP3 | — | ○ | ○ | ○ | ○ | ○ | ○ |
| | | Lower right | MP4 | — | ○ | ○ | ○ | ○ | ○ | ○ |

Controlling the projector by using RS-232C (continued)

| Classification | Items/Status | Selection Command | Adjustment Command | Analog RGB1 Analog RGB2 | Digital RGB | Video S-video | Y/PB/PR | Memory Card | Document Imaging Camera | |
|-----------------|-----------------------------|-------------------|--------------------|----------------------------|-------------|---------------|---------|-------------|-------------------------|---|
| Display | Menu background translucent | On | MB1 | — | ○ | ○ | ○ | ○ | ○ | |
| | | Off | MB0 | — | ○ | ○ | ○ | ○ | ○ | |
| | Start-up screen | On | MS0 | — | ○ | ○ | ○ | ○ | ○ | |
| | | Off | MS1 | — | ○ | ○ | ○ | ○ | ○ | |
| Default setting | Input source setting | | | | | | | | | |
| | COMPUTER-1 | On | I10 | — | ○ | ○ | ○ | ○ | ○ | |
| | | Off | I11 | — | ○ | ○ | ○ | ○ | ○ | |
| | | Analog RGB1 | IS0 | — | ○ | ○ | ○ | ○ | ○ | |
| | | Y/PB/PR | IS1 | — | ○ | ○ | ○ | ○ | ○ | |
| | COMPUTER-2 | On | I20 | — | ○ | ○ | ○ | ○ | ○ | |
| | | Off | I21 | — | ○ | ○ | ○ | ○ | ○ | |
| | | Analog RGB2 | IV0 | — | ○ | ○ | ○ | ○ | ○ | |
| | | Digital RGB | IV1 | — | ○ | ○ | ○ | ○ | ○ | |
| | Video | On | I30 | — | ○ | ○ | ○ | ○ | ○ | |
| | | Off | I31 | — | ○ | ○ | ○ | ○ | ○ | |
| | S-video | On | I40 | — | ○ | ○ | ○ | ○ | ○ | |
| | | Off | I41 | — | ○ | ○ | ○ | ○ | ○ | |
| | Memory card | On | I50 | — | ○ | ○ | ○ | ○ | ○ | |
| | | Off | I51 | — | ○ | ○ | ○ | ○ | ○ | |
| | Camera | On | I60 | — | ○ | ○ | ○ | ○ | ○ | |
| | | Off | I61 | — | ○ | ○ | ○ | ○ | ○ | |
| | Lamp power | Hi | LP0 | — | ○ | ○ | ○ | ○ | ○ | |
| | | Low | LP1 | — | ○ | ○ | ○ | ○ | ○ | |
| | Projection mode | Standard | PJ0 | — | ○ | ○ | ○ | ○ | ○ | |
| | | Rear | PJ1 | — | ○ | ○ | ○ | ○ | ○ | |
| | | Ceiling | PJ2 | — | ○ | ○ | ○ | ○ | ○ | |
| | | Rear ceiling | PJ3 | — | ○ | ○ | ○ | ○ | ○ | |
| | No signal power off | Off | PN0 | — | ○ | ○ | ○ | ○ | ○ | |
| | | 5 min. | PN1 | — | ○ | ○ | ○ | ○ | ○ | |
| | Power on | Manual | AP0 | — | ○ | ○ | ○ | ○ | ○ | |
| | | Auto | AP1 | — | ○ | ○ | ○ | ○ | ○ | |
| | Factory reset mode | Picture only | DRV | — | ○ | ○ | ○ | ○ | ○ | |
| | | All | DRS | — | ○ | ○ | ○ | ○ | ○ | |
| | Status display (CALL) | | | DON | — | ○ | ○ | ○ | ○ | ○ |

Controlling the projector by using RS-232C (continued)

| Classification | Items/Status | Selection Command | Adjustment Command | Analog RGB1 Analog RGB2 | Digital RGB | Video S-video | Y/PB/PR | Memory Card | Document Imaging Camera | |
|------------------------|--------------------------------------------------------|-------------------|--------------------|----------------------------|-------------|------------------|---------|-------------|-------------------------|---|
| Volume | Increase | VLU | - | ○ | ○ | ○ | ○ | - | - | |
| | Decrease | VLD | - | ○ | ○ | ○ | ○ | - | - | |
| Input select | Toggle | IN0 | - | ○ | ○ | ○ | ○ | ○ | ○ | |
| | COMPUTER-1 | IN1 | - | ○ | ○ | ○ | ○ | ○ | ○ | |
| | COMPUTER-2 | IN2 | - | ○ | ○ | ○ | ○ | ○ | ○ | |
| | Video | IN3 | - | ○ | ○ | ○ | ○ | ○ | ○ | |
| | S-video | IN4 | - | ○ | ○ | ○ | ○ | ○ | ○ | |
| | Memory card | IN5 | - | ○ | ○ | ○ | ○ | ○ | ○ | |
| | Camera | IN6 | - | ○ | ○ | ○ | ○ | ○ | ○ | |
| RESIZE | Increase the enlargement ratio | RUP | - | ○ | ○ | ○ | ○ | ○ | ○ | |
| | Decrease the enlargement ratio (Minimum: reset status) | RDW | - | ○ | ○ | ○ | ○ | ○ | ○ | |
| | Move the enlargement section | Upper | PO1 | - | ○ | ○ | ○ | ○ | ○ | ○ |
| | | Lower | PO2 | - | ○ | ○ | ○ | ○ | ○ | ○ |
| | | Lefter | PO3 | - | ○ | ○ | ○ | ○ | ○ | ○ |
| | | Righter | PO4 | - | ○ | ○ | ○ | ○ | ○ | ○ |
| | Enlargement reset | RS0 | - | ○ | ○ | ○ | ○ | ○ | ○ | |
| FREEZE | On | FON | - | ○ | ○ | ○ | ○ | ○ | ○ | |
| | Off | FOF | - | ○ | ○ | ○ | ○ | ○ | ○ | |
| MUTE | On | MON | - | ○ | ○ | ○ | ○ | ○ | ○ | |
| | Off | MOF | - | ○ | ○ | ○ | ○ | ○ | ○ | |
| PIP | On | PIN | - | ○ | ○ | - | - | - | - | |
| | Off | PIF | - | ○ | ○ | - | - | - | - | |
| | PIP input source | Video | PI0 | - | ○ | ○ | - | - | - | - |
| | | S-video | PI1 | - | ○ | ○ | - | - | - | - |
| | PIP size | Small | PS0 | - | ○ | ○ | - | - | - | - |
| | | Large | PS1 | - | ○ | ○ | - | - | - | - |
| | PIP position | Upper left | PP0 | - | ○ | ○ | - | - | - | - |
| | | Upper right | PP1 | - | ○ | ○ | - | - | - | - |
| | | Lower left | PP2 | - | ○ | ○ | - | - | - | - |
| | | Lower right | PP3 | - | ○ | ○ | - | - | - | - |
| PIP audio input source | Main | PA0 | - | ○ | ○ | - | - | - | - | |
| | Sub | PA1 | - | ○ | ○ | - | - | - | - | |

Controlling the projector by using RS-232C (continued)

| Classification | Items/Status | Selection Command | Adjustment Command | Analog RGB1 Analog RGB2 | Digital RGB | Video S-video | Y/PB/PR | Memory Card | Document Imaging Camera |
|-------------------------|-----------------------------------------|-------------------|--------------------|----------------------------|-------------|---------------|---------|-------------|-------------------------|
| AUTO SET | | PAT | — | ○ | ○ | — | — | — | — |
| AUTO KEYSTONE | | PKA | — | ○ | ○ | ○ | ○ | ○ | ○ |
| Memory card | Move Thumbnail (Thumbnail selection) | Up | JMU | — | — | — | — | ○ | — |
| | | Down | JMD | — | — | — | — | ○ | — |
| | | Left | JML | — | — | — | — | ○ | — |
| | | Right | JMR | — | — | — | — | ○ | — |
| | Move page | Next | JPN | — | — | — | — | ○ | — |
| | | Back | JPB | — | — | — | — | ○ | — |
| | Move folder | Up | JFU | — | — | — | — | ○ | — |
| | | Top | JFT | — | — | — | — | ○ | — |
| | Select | JFG | — | — | — | — | ○ | — | |
| | On-screen display | Pause | JFP | — | — | — | — | ○ | — |
| Quit | | JFE | — | — | — | — | ○ | — | |
| Document imaging camera | Short cut | | CDR | — | — | — | — | — | ○ |
| | Auto W/B | On | CW1 | — | — | — | — | — | ○ |
| | | Off | CW0 | — | — | — | — | — | ○ |
| | Lighting | On | CL1 | — | — | — | — | — | ○ |
| | | Off | CL0 | — | — | — | — | — | ○ |
| | Gain adjustment | Increase | CGU | — | — | — | — | — | ○ |
| | | Decrease | CGD | — | — | — | — | — | ○ |
| | Save picture | | CSV | — | — | — | — | — | ○ |



Discount-Merchant.com (800) 281-8860
 THE TRUSTED SOURCE FOR PROJECTOR LAMPS AND ACCESSORIES

Main unit

| | |
|---------------------------------------------|--------------------------------------------------------------------------------------------------------|
| Power consumption | No camera model: 320W (Standby: 18W) With camera model: 330W (Standby: 18W) |
| Mass | No camera model: 5.3kg With camera model: 6.2kg |
| Dimensions (Except the protrusion parts) | No camera model: 345 x 104 x 281 (mm) (W/H/D) With camera model: 345 x 104 x 336 (mm) (W/H/D) |
| Cabinet Material | ABS resin |
| Ambient environment | Temperature : 0°C to 35°C Humidity : 30% to 70% RH |
| Lamp | High pressure mercury lamp 210W |
| Projection screen size | 25 to 250 inches |
| Projection distance | 1.14 to 9.11m |
| Speaker | 2W (monaural) |
| Card slot | PC Card Standard TYPE II |
| Connectors | |
| COMPUTER IN 1 | Mini D-sub 15-pin Analog RGB/Y/P _B /P _R (combination) |
| COMPUTER IN 2 | DVI ANALOG & DIGITAL connector Analog RGB input/Digital RGB input (combination) |
| MONITOR OUT | Mini D-sub 15-pin Analog RGB |
| S-VIDEO IN | Mini DIN 4-pin |
| VIDEO IN | 1V(p-p), 75Ω, RCA pin jack |
| AUDIO (L/R) | 1V(p-p), more than 22kΩ, RCA pin jack x 2 |
| AUDIO IN | 1V(p-p), more than 22kΩ, ø3.5mm stereo mini jack |

| | |
|------------|---------------------------------------------------|
| AUDIO OUT | 1V(p-p), less than 2.2kΩ, ø3.5mm stereo mini jack |
| CONTROL | Mini DIN 8-pin (RS-232C) |
| USB output | Type B |

Liquid crystal display

| | |
|-------------------|----------------------------------------------|
| Projection system | 3-panels transmission |
| Panel size | 1.3 inches |
| Driving system | TFT active matrix |
| Picture elements | 786,432 pixels (1024 x 768 dots) (H./V.) x 3 |

Projection lens

| | |
|----------|--------------------------------------------|
| Lens | Zooming lens F = 2.2 to 2.5 f = 47 to 61mm |
| Focusing | Manual operation |
| Zooming | Manual operation |

Document imaging camera (With camera model)

| | |
|-------------------------------------|---------------------------------------------|
| Lens | F = 3.1, f = 6.4mm |
| Focus | Manual operation |
| Zoom | None (adjusted by distance to subject) |
| Iris | Auto./Manual |
| Image element | 1/2 inch CCD |
| Effective pixels for pickup section | 1,447,680 pixels (1392 x 1040 dots) (H./V.) |
| Lighting | LED light |

Discount-Merchant.com (800) 291-8800
 THE TRUSTED SOURCE FOR PROJECTOR LAMPS AND ACCESSORIES
 FixYourDLP.com
 Sponsored by DLP

Others

Accessories

| | |
|----------------------------------------|----------|
| Owner's manual (Getting started) | 1 |
| Owner's manual (CD-ROM) | 1 |
| Remote control | 1 |
| R6 (AA) size battery | 2 |
| Power cord | 1 |
| RGB cable | 1 (3m) |
| Adapter for Macintosh computers | 1 |
| AV cable | 1 (3m) |
| Audio cable (for Computer) | 1 (3m) |
| Control cable | 1 (1.8m) |
| USB cable | 1 (2m) |

- The design and specifications are subject to change without notice.

Sold separately

Replacement lamp TLPLX10



Discount-Merchant.com (800) 881-8860

THE TRUSTED SOURCE FOR PROJECTOR LAMPS AND OTHERS

Trademarks

NEC, PC-98 series are trademarks of NEC Corporation.

VGA, SVGA, XGA, SXGA, UXGA are trademarks or registered trademarks of International Business Machines Corporation. Macintosh is a registered trademark of Apple Computer, Inc.

Windows is a registered trademark of Microsoft Corporation in the U.S. and other countries.

Display Data Channel is a trademark of Video Electronics Standard Association.

SmartMedia™ is a trademark of Toshiba Corporation.

Other companies or product names are trademarks or registered trademarks of the respective companies.

TOSHIBA 3LCD Data Projector (TLP-X10/X20 Series)

Toshiba America Consumer Products, Inc. (TACP) makes the following limited warranties.

These limited warranties extend to the original end-user purchaser.

Limited two (2) Years Warranty of Parts and Labor

TACP warrants this product and its parts against defects in materials or workmanship for a period of two years after the date of original retail purchase.

For a period of two years after the date of original retail purchase, TACP will repair a defective product or a part, without charge to you.

This warranty also covers accessories of 3LCD Data Projector.

This warranty period of the lamp is ninety (90) days.

Your Responsibility

The above warranties are subject to the following conditions.

1. You must retain your bill of sale or provide other proof of purchase.
2. You must make a written notification within thirty (30) days after your discovery of a defective product or part.
3. All warranty servicing of this product or parts must be made by TACP or a service facility authorized by TACP.
4. These warranties are effective only if the product is purchased and operated in the USA.
5. Labor service charges for installation and adjustment of customer controls are not covered by this warranty.

6. Warranties extend only to defects in materials or workmanship as limited above and do not extend to any product or parts which have been lost or discarded by you or to damage to products or parts caused by misuse, accident, improper installation, improper maintenance or use in violation of instructions furnished by us; or to units which have been altered or modified without authorized of TACP or to damage to product or parts thereof which have had the serial number removed, altered, defaced or rendered illegible.
7. If it is determined after investigation that the claimed problem was not covered with this warranty, you shall pay the cost of investigation at prevailing rate.

Step-by-step procedure how to obtain warranty service

To obtain warranty servicing, you should:

1. Read the owners manual thoroughly before operating.
2. Please contact your dealer for an immediate service and an advice.
3. If your dealer is not able to assist you, please contact TACP Service Center listed below or a servicing facilities authorized by TACP for a warranty service within thirty (30) days after you find a defective product or part.
4. Arrange for a delivery of the product to TACP Service Center or a servicing facilities authorized by TACP.
5. The shipment of the product must be insured, safely and securely packed, preferably in the original carton or a carton with an equivalent protection. A letter explaining the defect and also a copy of the bill of sale or other proof of purchase must be enclosed. All transportation and insurance charges must be prepaid by you.

LIMITED WARRANTY (Continued)

6. The repaired product is returned freight prepaid to the purchaser after warranty servicing.
7. If you have any questions about service, please contact the following TACP Service Center.

TACP is not obligated to provide purchasers with a substitute unit during the warranty period.

82 Totowa Rd., Wayne,
NJ 07470, U.S.A.
Phone: (973) 628-8000
Fax: (973) 628-1875
Toll Free for Service Call: 1-800-631-3811

TOSHIBA AMERICA CONSUMER PRODUCTS, INC.



Discount-Merchant.com (800) 281-8860
THE TRUSTED SOURCE FOR PROJECTOR LAMPS AND ACCESSORIES



Disclaimer

This user manual is provided as a free service by FixYourDLP.com. FixYourDLP is in no way responsible for the content of this manual, nor do we guarantee its accuracy. FixYourDLP does not make any claim of copyright and all copyrights remain the property of their respective owners.

About FixYourDLP.com

FixYourDLP.com (<http://www.fixyourdlp.com>) is the World's #1 resource for media product news, reviews, do-it-yourself guides, and manuals.

Informational Blog: <http://www.fixyourdlp.com>

Video Guides: <http://www.fixyourdlp.com/guides>

User Forums: <http://www.fixyourdlp.com/forum>

FixYourDLP's Fight Against Counterfeit Lamps:

<http://www.fixyourdlp.com/counterfeits>

Sponsors:

RecycleYourLamp.org – Free lamp recycling services for used lamps:

<http://www.recycleyourlamp.org>

Lamp Research - The trusted 3rd party lamp research company:

<http://www.lampresearch.com>

Discount-Merchant.com – The worlds largest lamp distributor:

<http://www.discount-merchant.com>



FixYourDLP.com

Sponsored by 