



# Disclaimer

This user manual is provided as a free service by FixYourDLP.com. FixYourDLP is in no way responsible for the content of this manual, nor do we guarantee its accuracy. FixYourDLP does not make any claim of copyright and all copyrights remain the property of their respective owners.

About FixYourDLP.com

FixYourDLP.com (<http://www.fixyourdpl.com>) is the World's #1 resource for media product news, reviews, do-it-yourself guides, and manuals.

Informational Blog: <http://www.fixyourdpl.com>

Video Guides: <http://www.fixyourdpl.com/guides>

User Forums: <http://www.fixyourdpl.com/forum>

FixYourDLP's Fight Against Counterfeit Lamps:

<http://www.fixyourdpl.com/counterfeits>

## Sponsors:

RecycleYourLamp.org – Free lamp recycling services for used lamps:

<http://www.recycleyourlamp.org>

Lamp Research - The trusted 3rd party lamp research company:

<http://www.lampresearch.com>

Discount-Merchant.com – The worlds largest lamp distributor:

<http://www.discount-merchant.com>



**FixYourDLP.com**

Sponsored by 

**SANYO**

---

**Multimedia Projector**

**MODEL PLV-Z1**

**PLV-Z1BL**

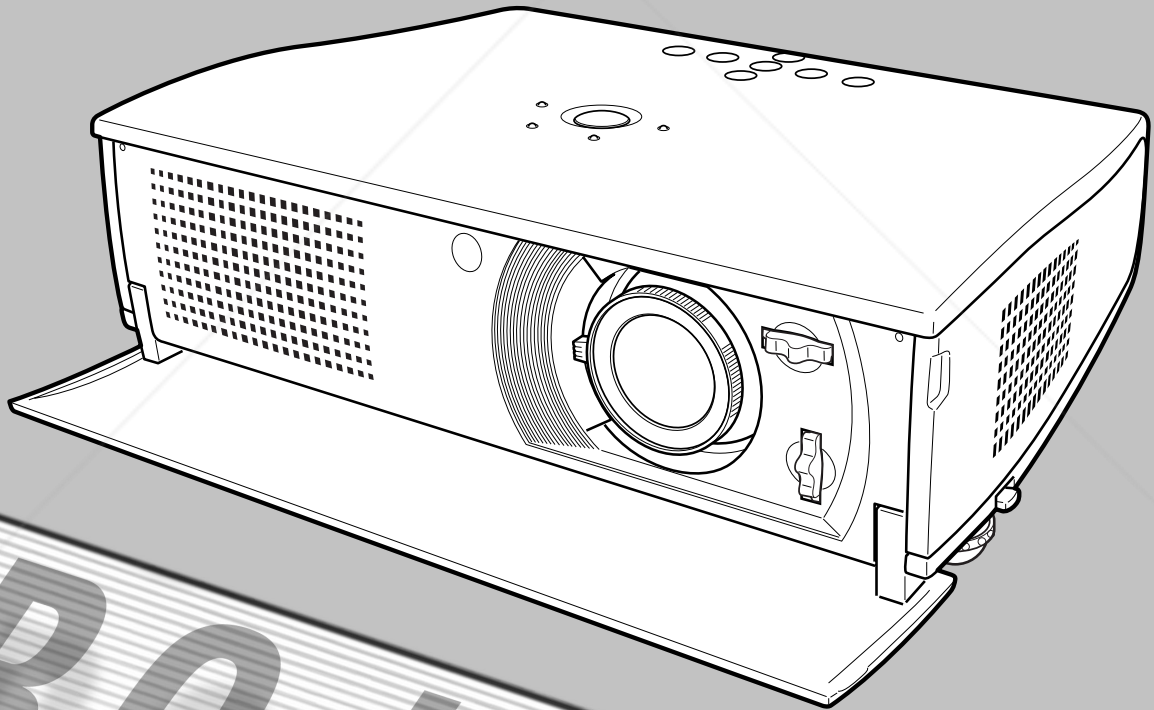

 **FixYourDLP.com**  
Sponsored by 

**Discount-Merchant.com (800) 281-9860**

**THE TRUSTED SOURCE FOR PROJECTOR LAMPS AND ACCESSORIES**

**Owner's Manual**

**PROJECTOR**

# Table of Contents

<b>Table of Contents</b>	<b>2</b>
--------------------------	----------

<b>To the Owner</b>	<b>3</b>
---------------------	----------

<b>Safety Instructions</b>	<b>4</b>
----------------------------	----------

<b>Compliance</b>	<b>6</b>
-------------------	----------

<b>Feature and Design</b>	<b>8</b>
---------------------------	----------

<b>Part Names and Functions</b>	<b>9</b>
---------------------------------	----------

Front	9
Bottom	10
Back	10
Terminal	11
Top Controls and Indicators	12
Remote Control	13
Remote Control Batteries Installation	14
Operating Range	14

<b>Installation</b>	<b>15</b>
---------------------	-----------

Positioning the Projector	15
Tilting the Projector	15
Moving the Lens	16
Connecting to Video Equipment	17
Connecting to a Computer	18

<b>Basic Operation</b>	<b>19</b>
------------------------	-----------

Turning On the Projector	19
Turning Off the Projector	19
Focus Adjustment	20
Zoom Adjustment	20
Keystone Adjustment	21
No Show Function	21
On-Screen Menu 	22
Contents of Menu	23

<b>Video Input</b>	<b>24</b>
--------------------	-----------

Input Source Selection (Direct Operation)	24
Input Source Selection (Menu Operation)	25
Video System Selection (Video/S-Video)	26
Video System Selection (Y-Pb/Cb-Pr/Cr)	26
Image Level Selection (Direct Operation)	27
Image Level Selection (Menu Operation)	27
Image Level Adjustment	28
Screen Size Adjustment (Direct Operation)	30
Screen Size Adjustment (Menu Operation)	30

<b>Computer Input / (RGB Scart 21-Pin Video Input)</b>	<b>31</b>
--	-----------

Input Source Selection (Direct Operation)	31
Input Source Selection (Menu Operation)	31
Computer System Selection	32
Compatible Computer System	33
Computer Adjustment (Auto) (Direct Operation)	34
Computer Adjustment (Auto) (Menu Operation)	34
Computer Adjustment (Manual)	35
Image Level Selection (Direct Operation)	38
Image Level Selection (Menu Operation)	38
Image Level Adjustment	39
Screen Size Adjustment (Direct Operation)	41
Screen Size Adjustment (Menu Operation)	41

<b>Setting</b>	<b>42</b>
----------------	-----------

Setting	42
---------	----

<b>Appendix</b>	<b>44</b>
-----------------	-----------

Lamp Replacement	44
Lamp Replace Counter	45
Warning Temp. Indicator	46
Air Filter Care and Cleaning	46
Cleaning the Projection Lens	46
Troubleshooting	47
Indicators and Projector Condition	48
Technical Specifications	49
Dimensions	50
Configuration of Terminals	51
Optional Parts	51



Discount-Merchant.com (800) 281-8860

## TRADEMARKS

- Apple, Macintosh, and PowerBook are trademarks or registered trademarks of Apple Computer, Inc.
- IBM, VGA, XGA, and PS/2 are trademarks or registered trademarks of International Business Machines, Inc.
- Windows and PowerPoint are registered trademarks of Microsoft Corporation.
- Each name of corporations or products in the owner's manual is a trademark or a registered trademark of its respective corporation.

# To the Owner

Before operating this projector, read this manual thoroughly and operate the projector properly.

This projector provides many convenient features and functions. Operating the projector properly enables you to manage those features and maintains it in better condition for a considerable time.

Improper operation may result in not only shortening the product-life, but also malfunctions, fire hazard, or other accidents.

If your projector seems to operate improperly, read this manual again, check operations and cable connections and try the solutions in the Troubleshooting section at the end of this manual. If the problem still persists, contact the sales dealer where you purchased the projector or the service center.



## SAFETY PRECAUTIONS

**WARNING : TO REDUCE THE RISK OF FIRE OR ELECTRIC SHOCK, DO NOT EXPOSE THIS APPLIANCE TO RAIN OR MOISTURE.**

- This projector produces intense light from the projection lens. Do not stare directly into the lens as it could possibly damage your eyes. Be especially careful that children do not stare directly into the beam.
- This projector should be set in the way indicated. If not, it may result in a fire hazard.
- Provide appropriate space on the top, sides and rear of the projector cabinet for allowing air circulation and cooling the projector. Minimum clearance must be maintained. If the projector is to be built into a compartment or similarly enclosed, the minimum distances must be maintained. Do not cover the ventilation slot on the projector. Heat build-up can reduce the service life of your projector, and can also be dangerous.
- Do not put any flammable object or spray can near the projector, hot air is exhausted from the ventilation holes.
- If the projector is not to be used for an extended time, unplug the projector from the power outlet.

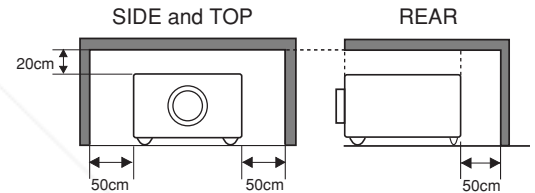

**READ AND KEEP THIS OWNER'S MANUAL FOR LATER USE.**



### CAUTION

**RISK OF ELECTRIC SHOCK  
DO NOT OPEN**



**CAUTION : TO REDUCE THE RISK OF ELECTRIC SHOCK, DO NOT REMOVE COVER (OR BACK). NO USER-SERVICEABLE PARTS INSIDE EXCEPT LAMP REPLACEMENT. REFER SERVICING TO QUALIFIED SERVICE PERSONNEL.**



THIS SYMBOL INDICATES THAT DANGEROUS VOLTAGE CONSTITUTING A RISK OF ELECTRIC SHOCK IS PRESENT WITHIN THIS UNIT.



THIS SYMBOL INDICATES THAT THERE ARE IMPORTANT OPERATING AND MAINTENANCE INSTRUCTIONS IN THE OWNER'S MANUAL WITH THIS UNIT.

# Safety Instructions

All the safety and operating instructions should be read before the product is operated.

Read all of the instructions given here and retain them for later use. Unplug this projector from AC power supply before cleaning. Do not use liquid or aerosol cleaners. Use a damp cloth for cleaning.

Follow all warnings and instructions marked on the projector.

For added protection to the projector during a lightning storm, or when it is left unattended and unused for long periods of time, unplug it from the wall outlet. This will prevent damage due to lightning and power line surges.

---

Do not expose this unit to rain or use near water... for example, in a wet basement, near a swimming pool, etc...

Do not use attachments not recommended by the manufacturer as they may cause hazards.

Do not place this projector on an unstable cart, stand, or table. The projector may fall, causing serious injury to a child or adult, and serious damage to the projector. Use only with a cart or stand recommended by the manufacturer, or sold with the projector. Wall or shelf mounting should follow the manufacturer's instructions, and should use a mounting kit approved by the manufacturers.

An appliance and cart combination should be moved with care. Quick stops, excessive force, and uneven surfaces may cause the appliance and cart combination to overturn.



---

Slots and openings in the back and bottom of the cabinet are provided for ventilation, to insure reliable operation of the equipment and to protect it from overheating.

The openings should never be covered with cloth or other materials, and the bottom opening should not be blocked by placing the projector on a bed, sofa, rug, or other similar surface. This projector should never be placed near or over a radiator or heat register.

This projector should not be placed in a built-in installation such as a book case unless proper ventilation is provided.

Never push objects of any kind into this projector through cabinet slots as they may touch dangerous voltage points or short out parts that could result in a fire or electric shock. Never spill liquid of any kind on the projector.

This projector should be operated only from the type of power source indicated on the marking label. If you are not sure of the type of power supplied, consult your authorized dealer or local power company.

Do not overload wall outlets and extension cords as this can result in fire or electric shock. Do not allow anything to rest on the power cord. Do not locate this projector where the cord may be damaged by persons walking on it.

Do not attempt to service this projector yourself as opening or removing covers may expose you to dangerous voltage or other hazards. Refer all servicing to qualified service personnel.

Unplug this projector from wall outlet and refer servicing to qualified service personnel under the following conditions:

- a. When the power cord or plug is damaged or frayed.
- b. If liquid has been spilled into the projector.
- c. If the projector has been exposed to rain or water.
- d. If the projector does not operate normally by following the operating instructions. Adjust only those controls that are covered by the operating instructions as improper adjustment of other controls may result in damage and will often require extensive work by a qualified technician to restore the projector to normal operation.
- e. If the projector has been dropped or the cabinet has been damaged.
- f. When the projector exhibits a distinct change in performance-this indicates a need for service.

When replacement parts are required, be sure the service technician has used replacement parts specified by the manufacturer that have the same characteristics as the original part. Unauthorized substitutions may result in fire, electric shock, or injury to persons.

Upon completion of any service or repairs to this projector, ask the service technician to perform routine safety checks to determine that the projector is in safe operating condition.

## Voor de klanten in Nederland



Bij dit product zijn batterijen geleverd. Wanneer deze leeg zijn, moet u ze niet weggoien maar inleveren als KCA.

## Moving the Projector

When moving the projector, close the front cover and retract the adjustable feet to prevent damage to the lens and cabinet. When the projector is not in use for an extended period, put it into a suitable case.



### CAUTION IN CARRYING OR TRANSPORTING THE PROJECTOR

- Do not drop or bump a projector, otherwise damages or malfunctions may result.
- When carrying a projector, use a suitable carrying case.
- Do not transport a projector by using a courier or transport service in an unsuitable transport case. This may cause damage to a projector. To transport a projector through a courier or transport service, consult your dealer for best way.

### NOTE

Moving the projector from a cool temperature location to a warm temperature location may result in moisture condensation on the Projection lens. In such an event, leave the projector OFF and wait until condensation disappears.

## Installing the Projector in a Proper Position

Install the projector in a proper position. Installation of improper position may reduce the lamp lifetime and cause fire hazard.

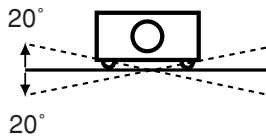

Do not tilt the projector more than 20 degrees on either side.



**NO UPWARD**

Do not put the projector upward and project an image.



**NO DOWNWARD**

Do not put the projector downward and project an image.



**NO SIDEWAY**

Do not put the projector sideways and project an image.



**Discount-Merchant.com (800) 281-8860**

**THE TRUSTED SOURCE FOR PROJECTOR LAMPS AND ACCESSORIES**



# Compliance

## Federal Communication Commission Notice

Note : This equipment has been tested and found to comply with the limits for a Class B digital device, pursuant to part 15 of the FCC Rules. These limits are designed to provide reasonable protection against harmful interference in a residential installation. This equipment generates, uses and can radiate radio frequency energy and, if not installed and used in accordance with the instructions, may cause harmful interference to radio communications. However, there is no guarantee that interference will not occur in a particular installation. If this equipment does cause harmful interference to radio or television reception, which can be determined by turning the equipment off and on, the user is encouraged to try to correct the interference by one or more of the following measures :

- Reorient or relocate the receiving antenna.
- Increase the separation between the equipment and receiver.
- Connect the equipment into an outlet on a circuit different from that to which the receiver is connected.
- Consult the dealer or an experienced radio/TV technician for help.

Use of shielded cable is required to comply with class B limits in Subpart B of Part 15 of FCC Rules.

Do not make any changes or modifications to the equipment unless otherwise specified in the instructions. If such changes or modifications should be made, you could be required to stop operation of the equipment.

Model Number : PLV-Z1, PLV-Z1BL  
Trade Name : Sanyo  
Responsible party : SANYO FISHER COMPANY  
Address : 21605 Plummer Street, Chatsworth, California 91311  
Telephone No. : (818)998-7322

## AC POWER CORD REQUIREMENT

The AC Power Cord supplied with this projector meets the requirement for use in the country you purchased it.

### AC Power Cord for the United States and Canada :

AC Power Cord used in the United States and Canada is listed by the Underwriters Laboratories (UL) and certified by the Canadian Standard Association (CSA).

AC Power Cord has a grounding-type AC line plug. This is a safety feature to be sure that the plug will fit into the power outlet. Do not try to defeat this safety feature. Should you be unable to insert the plug into the outlet, contact your electrician.

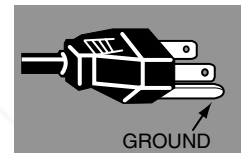

### AC Power Cord for the United Kingdom :

This cord is already fitted with a moulded plug incorporating a fuse, the value of which is indicated on the pin face of the plug. Should the fuse need to be replaced, an ASTA approved BS 1362 fuse must be used of the same rating, marked thus  $\diamond$ . If the fuse cover is detachable, never use the plug with the cover omitted. If a replacement fuse cover is required, ensure it is of the same colour as that visible on the pin face of the plug (i.e. red or orange). Fuse covers are available from the Parts Department indicated in your User Instructions.

If the plug supplied is not suitable for your socket outlet, it should be cut off and destroyed.

The end of the flexible cord should be suitably prepared and the correct plug fitted. (See Over)

**WARNING : A PLUG WITH BARED FLEXIBLE CORD IS HAZARDOUS IF ENGAGED IN A LIVE SOCKET OUTLET.**

The Wires in this mains lead are coloured in accordance with the following code:

Green-and-yellow ..... Earth  
Blue ..... Neutral  
Brown ..... Live

As the colours of the wires in the mains lead of this apparatus may not correspond with the coloured markings identifying the terminals in your plug proceed as follows:

The wire which is coloured green-and-yellow must be connected to the terminal in the plug which is marked by the letter E or by the safety earth symbol  $\perp$  or coloured green or green-and-yellow.

The wire which is coloured blue must be connected to the terminal which is marked with the letter N or coloured black.

The wire which is coloured brown must be connected to the terminal which is marked with the letter L or coloured red.

**WARNING : THIS APPARATUS MUST BE EARTHED.**

**THE SOCKET-OUTLET SHOULD BE INSTALLED NEAR THE EQUIPMENT AND EASILY ACCESSIBLE.**

## Connecting the AC Power Cord

This projector uses nominal input voltages of 100-120 V or 200-240 V AC. This projector automatically selects the correct input voltage. It is designed to work with single-phase power systems having a grounded neutral conductor. To reduce risk of electrical shock, do not plug into any other type of power system. Consult your authorized dealer or service station if you are not sure of the type of power being supplied. Connect a projector with all peripheral equipment before turning a projector on. (Refer to page 11, 17, and 18 for connection.)



### CAUTION

For safety, unplug AC Power Cord when the projector is not in use.

When this projector is connected to the outlet with AC Power Cord and the MAIN ON/OFF switch is on, it is in Stand-by mode and consumes a little electric power. Turn the MAIN ON/OFF switch off when the projector is not in use.

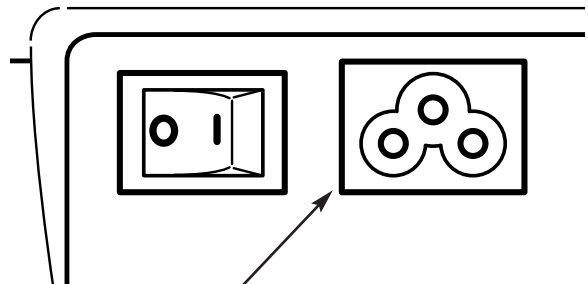

Connect AC Power Cord (supplied) to the projector. The AC outlet must be near this equipment and must be easily accessible.

### NOTE ON THE POWER CORD

AC Power Cord must meet requirement of the country where you use a projector. Confirm an AC plug type with the chart below and proper AC Power Cord must be used. If supplied AC Power Cord does not match your AC outlet, contact your sales dealer.

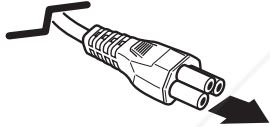
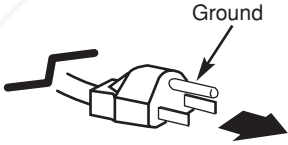
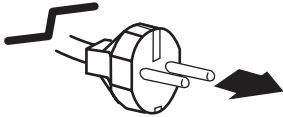
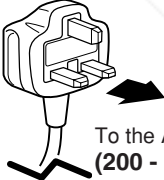
Projector side	AC Outlet side		
 <p>To POWER CORD CONNECTOR on your projector.</p>	<p>For the U.S.A. and Canada</p>  <p>To the AC Outlet. (120 V AC)</p>	<p>For Continental Europe</p>  <p>To the AC Outlet. (200 - 240 V AC)</p>	<p>For the U.K.</p>  <p>To the AC Outlet. (200 - 240 V AC)</p>



**Discount-Merchant.com (800) 281-8860**  
**THE TRUSTED SOURCE FOR PROJECTOR LAMPS AND ACCESSORIES**



# Feature and Design

This Multimedia Projector is designed with the most advanced technology for portability, durability, and ease of use. This projector utilizes built-in multimedia features, a palette of 16.77 million colors, and matrix liquid crystal display (LCD) technology.

## ◆ Short Zoom Lens

---

This projector is equipped with Short Zoom Lens which allows you to enjoy 100" screen size in range of 9.8' (3.0m) to 11.8' (3.6m).

## ◆ Lens Shift

---

The Lens Shift function gives you less limitation in positioning the projector. You can use it at desired places without a distorted image.

## ◆ Compact Design

---

This projector is extremely compact in size and weight. It is designed to be carried anywhere you wish to use.

## ◆ Compatibility

---

This projector widely accepts various video and computer input signals including;

- **Computers**  
IBM-compatible or Macintosh computer up to 1280 x 1024 resolution.
- **6 Color Systems**  
NTSC, PAL, SECAM, NTSC 4.43, PAL-M or PAL-N color system can be connected.
- **Component Video**  
Component video signal, such as a DVD player output, high definition TV signals including 480i, 480p, 575i, 575p, 720p, 1035i or 1080i, can be connected.
- **S-Video**  
S-Video signal, such as a S-VHS VCR output signal, can be connected.

## ◆ High Resolution Image

---

This projector provides 964 x 544 dots resolution for computer input. Resolution from a computer more than 964 x 544 and less than SXGA (1280 x 1024) is compressed into 964 x 544 dots. This projector cannot display image of over 1280 x 1024 dots. When resolution of your computer is higher than 1280 x 1024, reset a computer output for lower resolution.

## ◆ Multi-Scan System

---

This projector has Multi-Scan System to conform to almost all computer output signals quickly. There is no need for troublesome manual adjustment of frequency and other settings.

## ◆ 16 : 9 Wide Screen

---

The projector is equipped with LCD panels of 16 : 9 ratio so that you can project the image from component video signal such as a DVD player and high definition TV in a full screen.

## ◆ One-Touch Auto PC Adjustment

---

Incoming computer video signals are recognized and the best adjustment is automatically set by Auto PC Adjustment. No complicated setup is necessary and projection is always precise.

## ◆ Keystone Correction

---

Positioning height of a projector may result in distorted image being displayed in a trapezoid shape. Keystone Correction solves this problem by digitally altering projection to produce undistorted images.

## ◆ Power Management

---

The Power management function is provided to reduce power consumption while the projector is not in use. This Power management function operates to turn the Projection lamp off when the projector detects signal interruption and any button is not pressed over 5 minutes. The Projection lamp is automatically turned on again when the projector detects signal or any operation button is pressed. This projector is shipped with this function ON.

## ◆ Lamp Mode

---

Either the Bright mode or the Theater black mode is available in the Setting menu. The Theater black mode is suitable for seeing a movie since it makes the image best for a movie in low noise.

## ◆ Multilanguage Menu Display

---

Operation menu is displayed in English, German, French, Italian, Spanish, Portuguese, Dutch, Swedish, Russian, Chinese, Korean, or Japanese.

## ◆ Illumination Buttons

---

The Remote Control employs the Light button and the Luminous buttons that emit light to be used easily in a dark place.



FixYourDLP.com

DiscountMerchant.com (800) 281-8860  
THE TRUSTED SOURCE FOR PROJECTOR LAMPS AND ACCESSORIES

# Part Names and Functions

## Front



### CAUTION

This projector is equipped with Cooling Fans for protection from overheating. Pay attention to the following to ensure proper ventilation and avoid a possible risk of fire and malfunction.

- Do not cover vent holes.
- Keep back and bottom clear of any object. Obstructions may block cooling air.

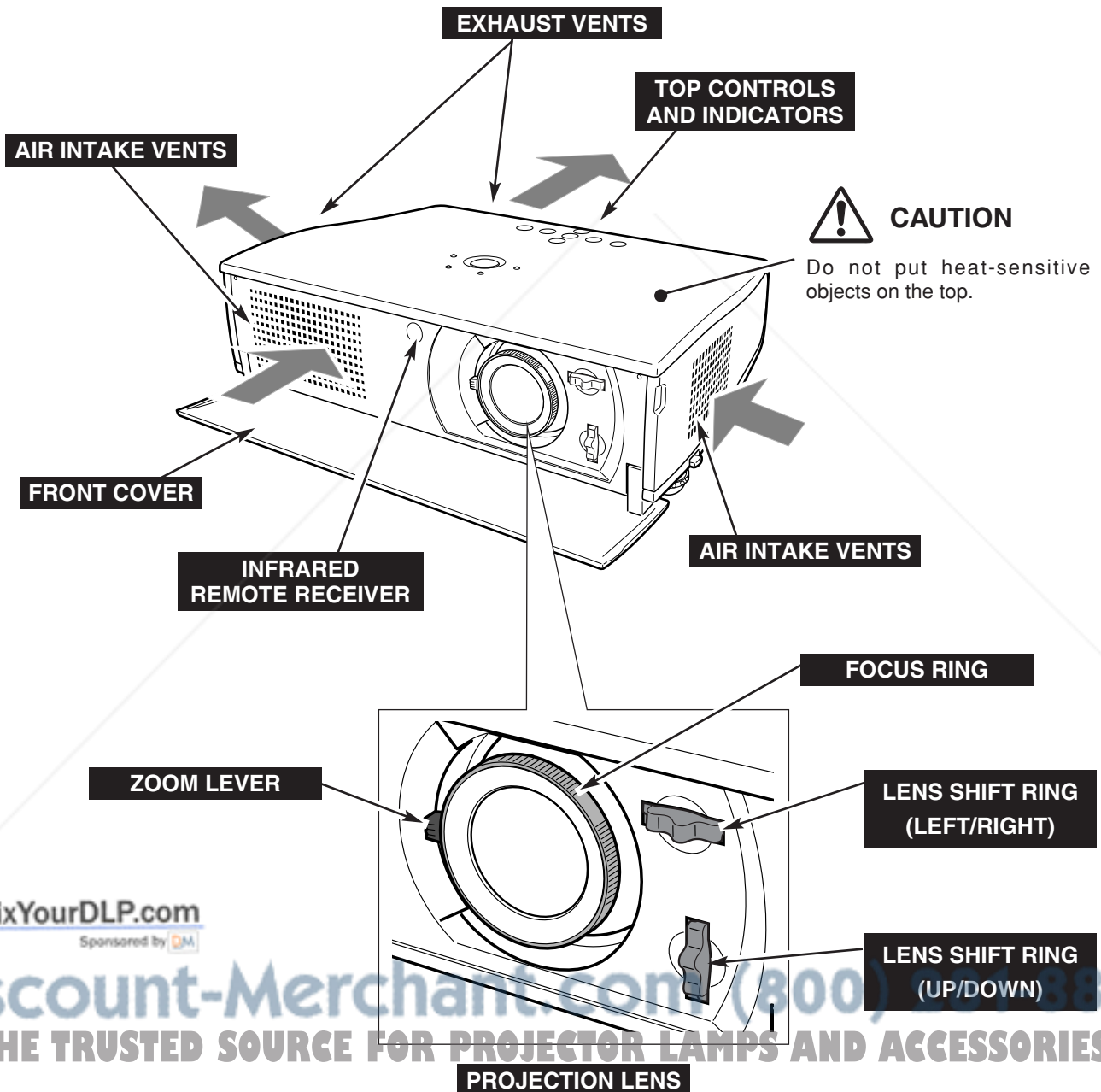

FixYourDLP.com

Sponsored by DM

Discount-Merchants.com (800) 360-360

THE TRUSTED SOURCE FOR PROJECTOR LAMPS AND ACCESSORIES

## Bottom

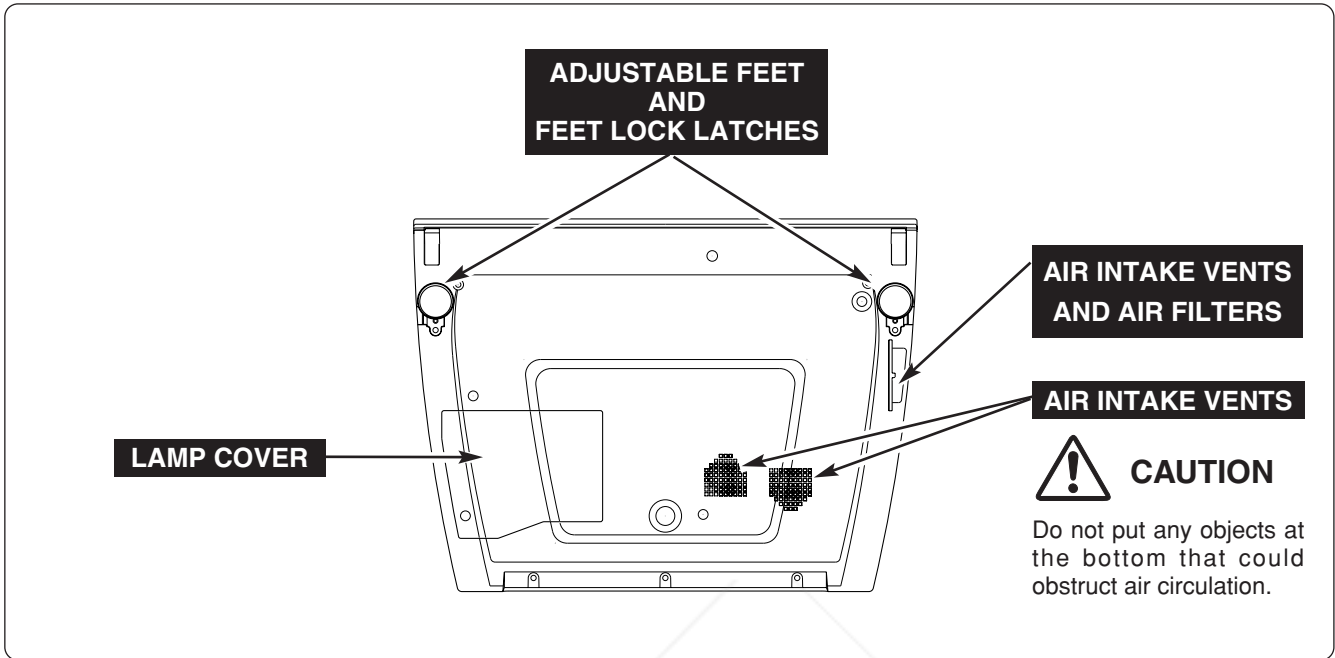

## Back

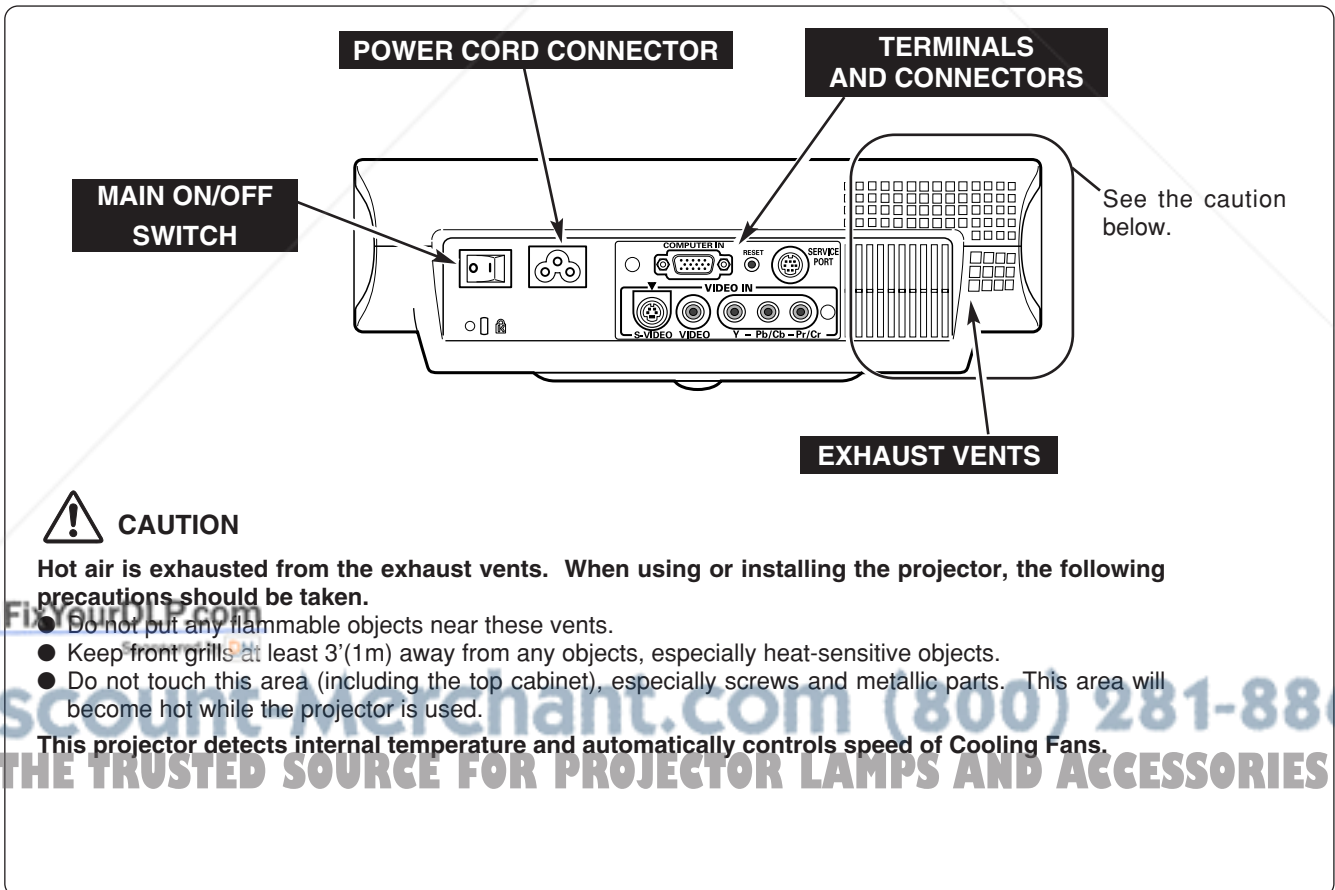

Terminal

**COMPUTER INPUT TERMINAL**

Connect the computer output to this jack. (Refer to page 18.)

**SERVICE PORT JACK**

This jack is used to service this projector.

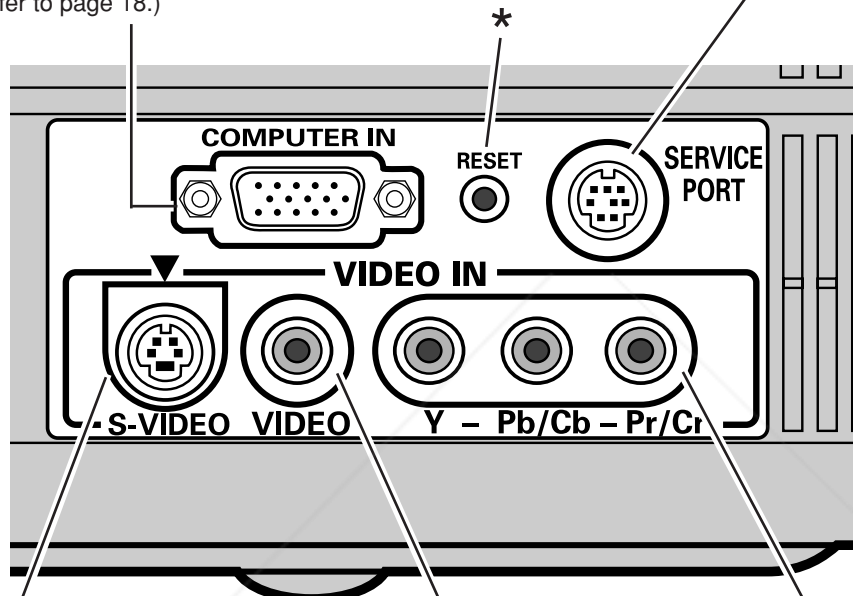

**S-VIDEO INPUT JACK**

Connect the S-VIDEO output from video equipment to this jack. (Refer to page 17.)

**VIDEO INPUT JACK (VIDEO)**

Connect the composite video output from video equipment to VIDEO jack. (Refer to page 17.)

**COMPONENT VIDEO INPUT JACK (Y-Pb/Cb-Pr/Cr)**

Connect the component video outputs to Y, Pb/Cb, and Pr/Cr jacks. (Refer to page 17.)

\* This projector uses a micro processor to control this unit, and occasionally, this micro processor may malfunction and need to be reset. This can be done by pressing the RESET button with a pen, which will shut down and restart the unit. Do not use the RESET function excessively.



**Discount-Merchant.com (800) 281-8860**  
**THE TRUSTED SOURCE FOR PROJECTOR LAMPS AND ACCESSORIES**

## Top Controls and Indicators

### LAMP REPLACE INDICATOR

Turns yellow when the life of the projection lamp draws to an end. (p44)

### WARNING TEMP. INDICATOR

Flashes red when internal projector temperature is too high. (p46)

### READY INDICATOR

Lights green when the projector is ready to be turned on. And it flashes green in Power management mode. (p43)

### LAMP INDICATOR

Becomes dim when the projector is turned on. And it is bright when the projector is in stand-by mode.

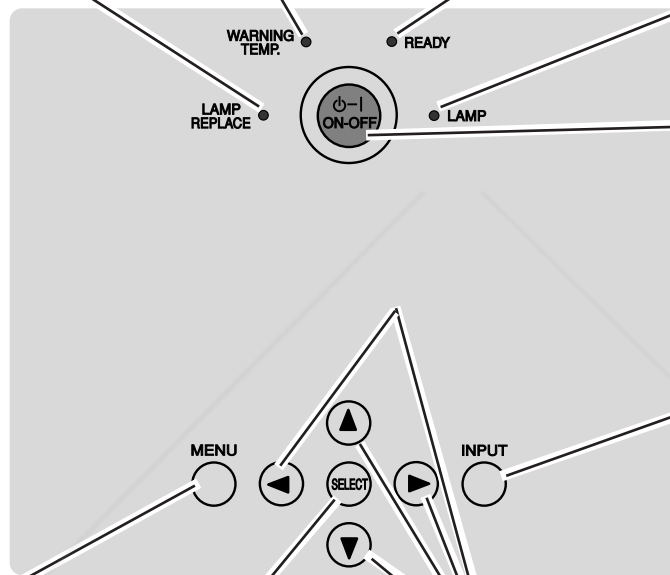

### POWER ON-OFF BUTTON

Used to turn the projector on or off. (p19)

### INPUT BUTTON

Used to select input source. (p24, 31)

### MENU BUTTON

Used to open or close the on-screen menu. (p22)

### SELECT BUTTON

Used to execute the item selected. It is also used to expand the image in Digital zoom mode. (p41)

### POINT BUTTONS

Used to select an item or adjust value in the on-screen menu. They are also used to pan the image in Digital zoom mode. (p41)

Remote Control

**LIGHT BUTTON**  
Used to light the following buttons for about 10 seconds: LIGHT, ON-OFF, AUTO, MENU, SCREEN, INPUT, and IMAGE.

**AUTO PC ADJ. BUTTON**  
Used to operate Auto PC Adjustment function. (p34)

**MENU BUTTON**  
Used to open or close the On-screen menu. (p22)

**INPUT BUTTON**  
Used to select input source. (p24, 31)

**NO SHOW BUTTON**  
Used to turn the picture into black image. (p21)

**VIDEO BUTTON**  
Used to select video input source. (p24)

**LUMINOUS BUTTONS**  
The luminous buttons in the frame emit light in a dark place after they are put under light for a while.

**POWER ON-OFF BUTTON**  
Used to turn the projector on or off. (p19)

**SCREEN BUTTON**  
Used to select screen size. (p30, 41)

**POINT BUTTONS**  
Used to select an item or adjust value in the on-screen menu. They are also used to pan the image in Digital zoom mode. (p41)

**SELECT BUTTON**  
Used to execute the item selected. It is also used to expand the image in Digital zoom mode. (p41)

**IMAGE BUTTON**  
Used to select image level. (p27, 38)

**KEYSTONE BUTTONS**  
Used to correct the keystone distortion. (p21, 42)

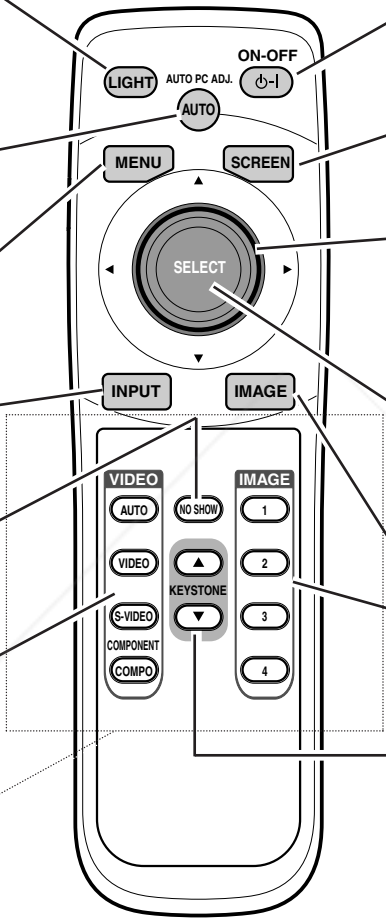

FixYourDL.com  
 To insure safe operation, please observe the following precautions :  
 ● Do not bend, drop the remote control, or expose the remote control to moisture or heat.  
 ● For cleaning, use soft dry cloth. Do not apply benzene, thinner, splay or any chemical material.

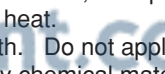
Discount  (800) 281-8860  
 THE TRUSTED SOURCE FOR PROJECTOR LAMPS AND ACCESSORIES



## Remote Control Batteries Installation

**1** Remove the battery compartment lid.

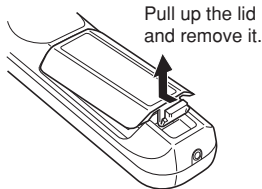

**2** Slide the batteries into compartment.

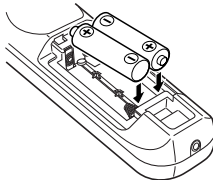

**Two AA size batteries**  
For correct polarity (+ and -), be sure battery terminals are in contact with pins in compartment.

**3** Replace the compartment lid.

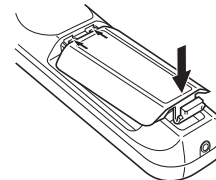

\* When the batteries of the remote control are replaced, the remote control code automatically returns to the initial code (Code 2)(p43).



To insure safe operation, please observe the following precautions:

- Use (2) AA, UM3 or R06 type alkaline batteries.
- Replace two batteries at the same time.
- Do not use a new battery with a used battery.
- Avoid contact with water or liquid.
- Do not expose the remote control to moisture, or heat.
- Do not drop the remote control.
- If a battery has leaked on the remote control, carefully wipe case clean and install new batteries.
- Risk of explosion if battery is replaced by an incorrect type.
- Dispose of used batteries according to the instructions.

## Operating Range

Point the remote control toward the projector (Infrared Remote Receiver) whenever pressing any button. Maximum operating range for the remote control is about 16.4' (5m) and 60° in front of the projector.

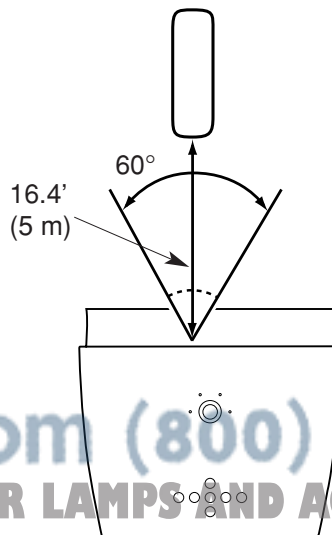

# Installation

## Positioning the Projector

- This projector is designed to project on a flat projection surface.
- The projector can be focused from 3.6'(1.1m) ~ 19.7'(6.0m).
- Refer to the figure below to adjust a screen size.

\*The lens is at the top of the lens shift.

### ROOM LIGHT

The brightness in a room has a great influence on picture quality. It is recommended to limit ambient lighting in order to provide the best image.

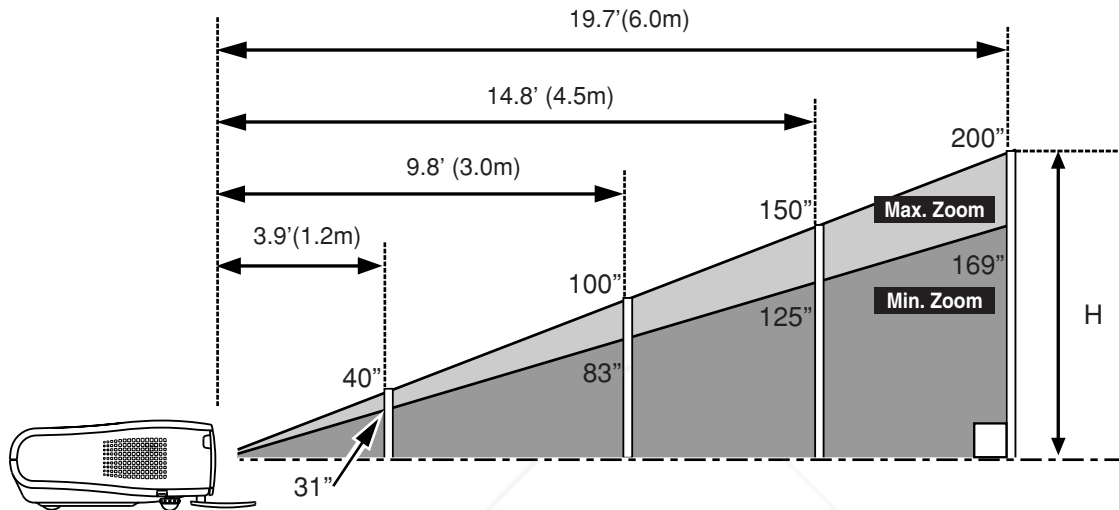

Screen Size (W x H) mm	30"	40"	100"	150"	200"
Zoom (min)	3.6'(1.1m)	4.6'(1.4m)	11.8'(3.6m)	17.7'(5.4m)	—
Zoom (max)	—	3.9'(1.2m)	9.8'(3.0m)	14.8'(4.5m)	19.7'(6.0m)

## Tilting the Projector

Picture tilt and projection angle can be adjusted by rotating the Adjustable feet. Projection angle can be adjusted up to 11.8 degrees with the Adjustable feet.

- 1 Lift the front of the projector and pull the Feet lock latches on both sides of the projector.
- 2 Release the Feet lock latches to lock the Adjustable feet and rotate the Adjustable feet to adjust position and tilt.
- 3 To retract the Adjustable feet, lift the front of the projector and pull and undo the Feet lock latches.

Keystone distortion of a projected image can be adjusted by menu operation or the remote control. (Refer to page 21 and 42.)

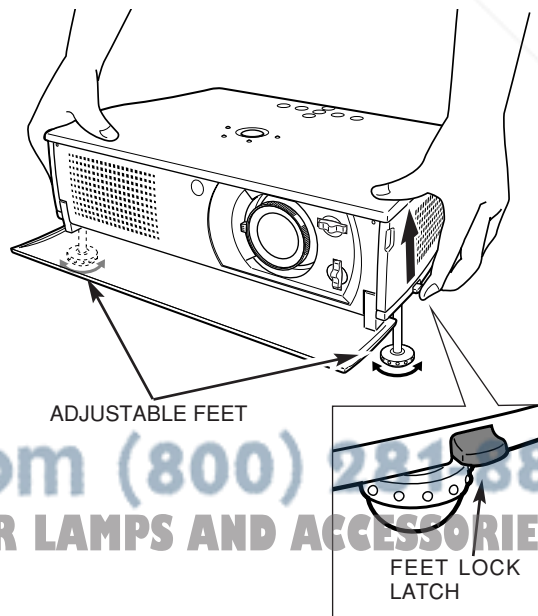

FixYourDLP.com  
Sponsored by DJM

Discount-Merchant.com (800) 281-5860

**CAUTION**

Tilt the projector within the adjustable range in order not to shorten the life of the lamp. Proper angle should be taken. Refer to page 5.

## Moving the Lens

The Projection lens can be moved up and down with manual lens shift function. This function makes it easy to provide a projected image where you want. U/D ratio can be adjusted from 10 : 0 ~ 0 : 10 (refer to the figures below).

Turn the lens shift ring (left/right) left/right to move the lens leftward / rightward.

Turn the lens shift ring (up/down) up/down to move the lens upward / downward.

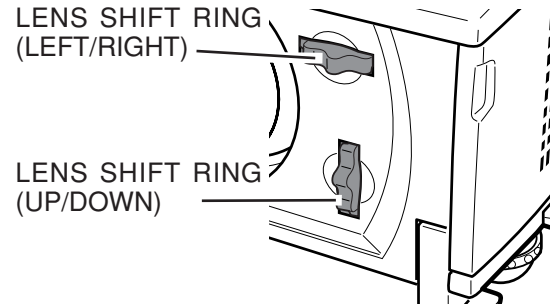

### LENS SHIFT UP/DOWN

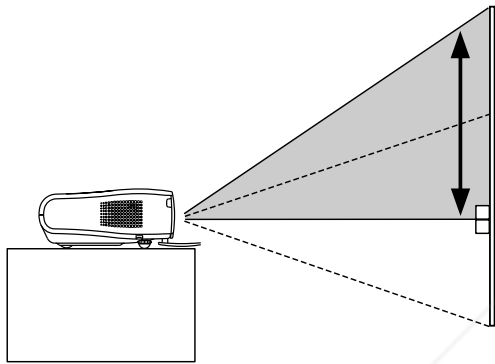

UPPERMOST

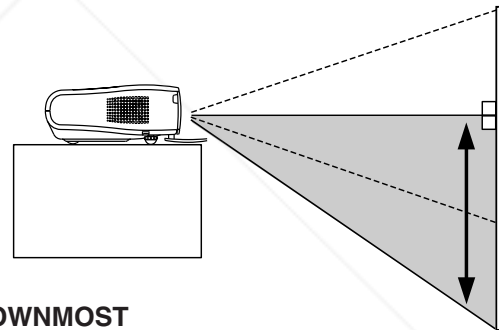

DOWNMOST

### LENS SHIFT LEFT/RIGHT

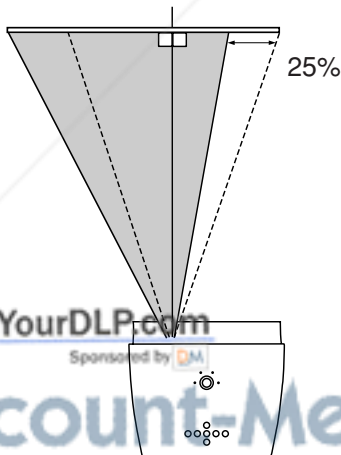

LEFTMOST

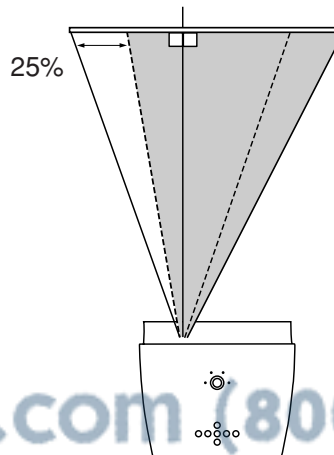

RIGHTMOST

#### NOTE

The best image is generally obtained at the center without the Lens shift.

## Connecting to Video Equipment

### Cables used for connection

- Video Cable (RCA x 1 or RCA x 3)
- S-VIDEO Cable
- Scart-VGA Cable

\*Only a video cable is included.

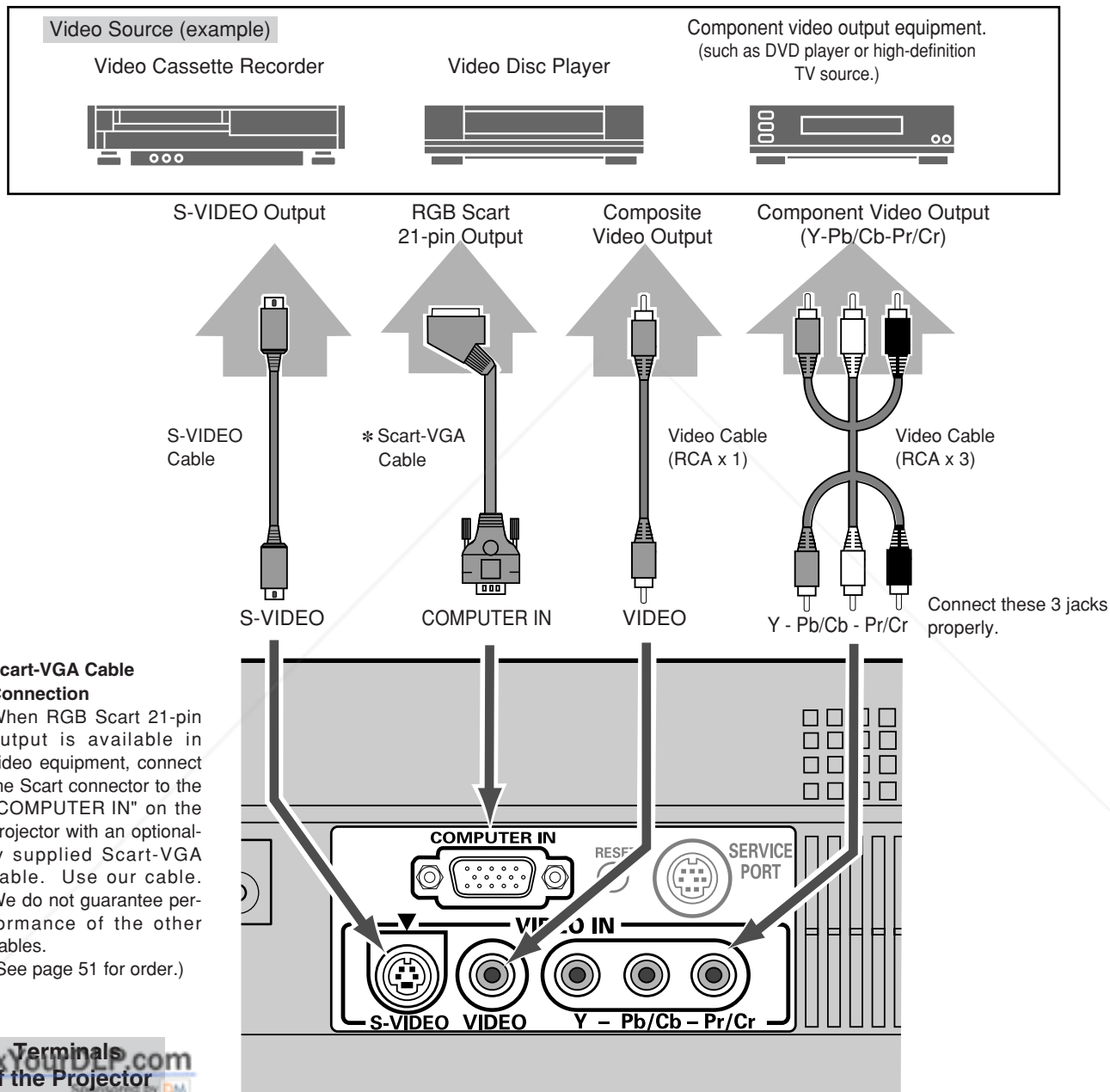

#### \* Scart-VGA Cable

##### Connection

When RGB Scart 21-pin output is available in video equipment, connect the Scart connector to the "COMPUTER IN" on the projector with an optionally supplied Scart-VGA cable. Use our cable. We do not guarantee performance of the other cables. (See page 51 for order.)



Discount-Merchant.com (800) 281-8860

#### NOTE

When selecting the video input with the "AUTO" on the remote control or through menu operation, the projector selects connection in the following order:

- 1st Y-Pb/Cb-Pr/Cr
- 2nd S-VIDEO
- 3rd VIDEO

**NOTE :** When connecting the cable, the power cords of both the projector and the external equipment should be disconnected from AC outlet.

## Connecting to a Computer

### Cables used for connection

- VGA Cable (HDB 15 pin) \*
- MAC Adapter (When connecting to Macintosh computer) \*
- \* option

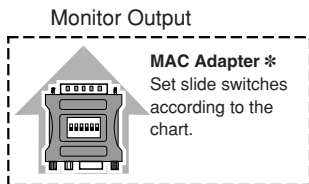
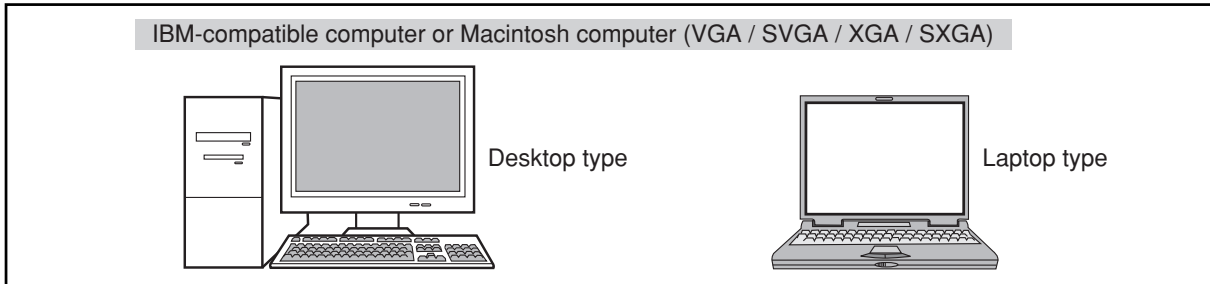

◆ **MAC ADAPTER (Not supplied)**

Set switches as shown in the table below depending on RESOLUTION MODE that you want to use before you turn on projector and computer.

ON

OFF

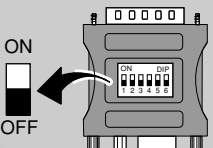

	1	2	3	4	5	6
13" MODE (640 x 480)	ON	ON	OFF	OFF	OFF	OFF
16" MODE (832 x 624)	OFF	ON	OFF	ON	OFF	OFF
19" MODE (1024 x 768)	OFF	ON	ON	OFF	OFF	OFF
21" MODE (1152 x 870)	ON	ON	ON	ON	OFF	OFF

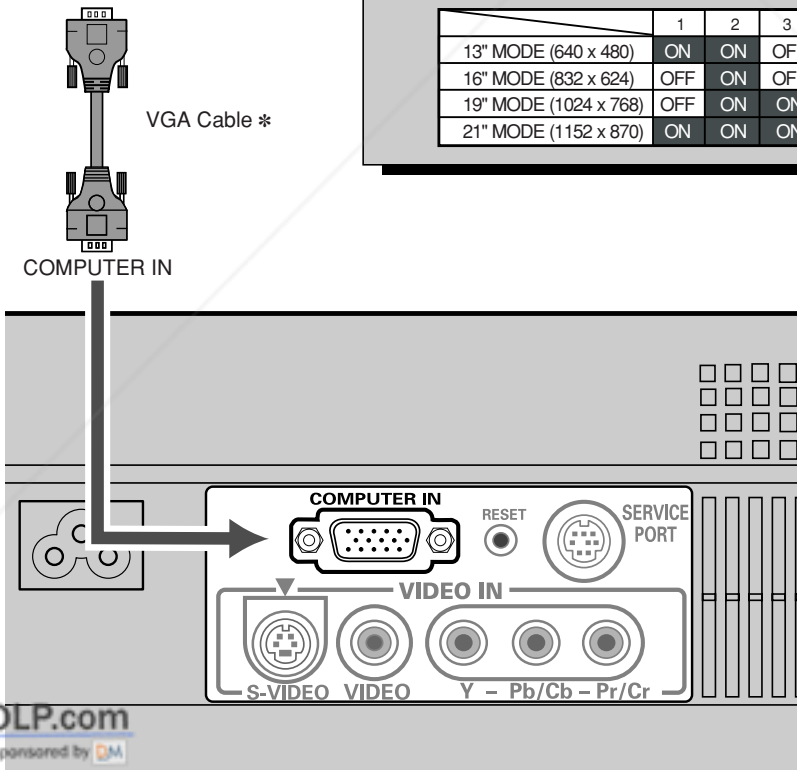

Terminals  
of the Projector



 **NOTE :**  
When connecting the cable, the power cords of both the projector and the external equipment should be disconnected from AC outlet. Turn the projector and peripheral equipment on before the computer is switched on.

# Basic Operation

## Turning On the Projector

- 1 Complete peripheral connections (with Computer, VCR, etc.) before turning on the projector.
- 2 Connect the projector's AC Power Cord into an AC outlet, and open the front cover. Turn the MAIN ON/OFF switch on. The LAMP indicator lights red, and the READY indicator lights green. The READY indicator does not light green with the front cover closed.
- 3 Press the POWER ON-OFF button on the top control or on the remote control. The LAMP indicator dims, and cooling fans start to operate. Preparation display appears on a screen and the count-down starts (for 30 seconds).
- 4 The input source that is selected last and the Lamp mode status icon appears on a screen after the count-down. Select input source of either video or computer. (Refer to page 24 or 31.)

### Lamp mode

-  Bright light (Bright mode)
-  Light with head gray (Theater black mode)

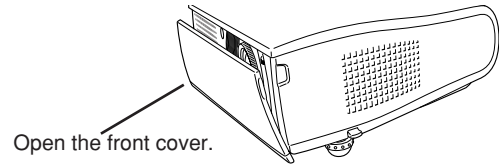

### MAIN ON/OFF switch

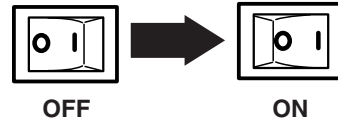

### Lamp mode

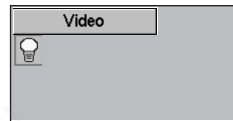

\*Refer to page 43 for the Lamp mode.

## Turning Off the Projector

- 1 Press the POWER ON-OFF button on the top control or the remote control, and a message "Power off?" appears on a screen. The message is not displayed and the projector is turned off when the Power off confirmation function is off. (See the Setting menu on page 43.)
- 2 Press the POWER ON-OFF button again to turn off the projector. The LAMP indicator lights bright and the READY indicator turns off. The cooling fans operate for about 90 seconds. During this "Cooling Down" period, leave the front cover open. (The projector cannot be turned on.)
- 3 When the projector has cooled down, the READY indicator lights green again. Turn the MAIN ON/OFF switch off and disconnect the AC Power Cord. **Do not disconnect the AC Power Cord before the READY indicator lights green.**

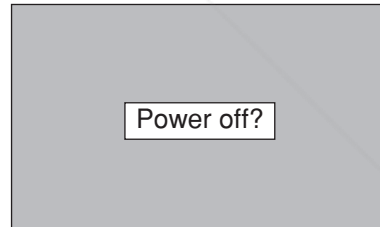

Message disappears after 4 seconds.



### CAUTION

For safety, the projector will be turned off when the front cover is closed in the middle of operation. However, do not close the front cover for the purpose of turning off the projector. Close the front cover after the projector has cooled down and the READY indicator lights green.

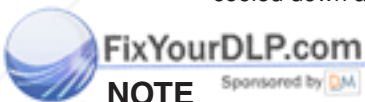

### NOTE

To maintain the life of the lamp, once you turn the projector on, wait at least 5 minutes before turning it off.

Do not use the projector for more than 24 hours continuously. Turn off the projector at least once in 24 hours and give it a rest. Continuous use may result in shortening the lamp lifetime.

When the "Power management" function is ON, the projector detects signal interruption and turns off the Projection lamp automatically. Refer to "Power management" on page 43.

When the WARNING TEMP. indicator flashes red, the projector is automatically turned off. Wait at least 5 minutes before turning on the projector again. (Refer to the section "Warning Temp. Indicator" on page 46.)



### Focus Adjustment

Rotate the FOCUS RING to adjust the projected picture focus.

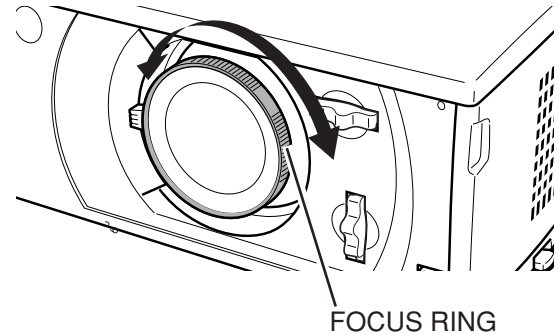

### Zoom Adjustment

Move the ZOOM LEVER upward to make the image larger. Move the ZOOM LEVER downward to make the image smaller.

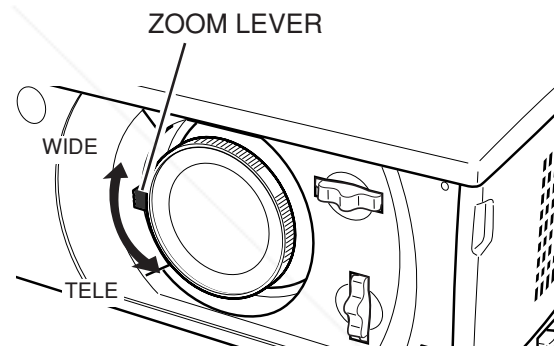

## Keystone Adjustment

If a projected picture has keystone distortion, correct the image with Keystone Adjustment.

- 1** Press the KEYSTONE ▲/▼ button on the remote control or select the Keystone in the Setting menu. (Refer to page 42.) The Keystone dialog box appears.
- 2** Correct keystone distortion by pressing the KEYSTONE ▲/▼ button or the POINT UP/DOWN button. Press the KEYSTONE ▲ button or the POINT UP button to reduce the upper part of image, and press the KEYSTONE ▼ button or the POINT DOWN button to reduce the lower part.



- The arrows are white when there is no correction.
- The arrow disappears at the maximum correction.
- The direction of the arrow being corrected turns purple.

Reduce the upper width with the KEYSTONE ▲ button or the POINT UP button.

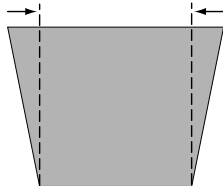

Reduce the lower width with the KEYSTONE ▼ button or the POINT DOWN button.

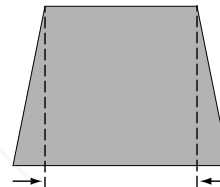

### Keystone Adjustment Hint

Use the Lens shift function first to move the screen for the quality of image before using the Keystone adjustment function. Moving the screen with the Lens shift function produces a better image than keystone adjustment function.

## No Show Function

Press the NO SHOW button on the remote control to black out the image. To restore to normal, press the NO SHOW button again or press any other button.

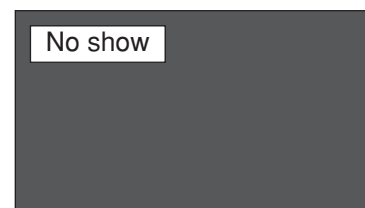

Message disappears after 4 seconds.

## On-Screen Menu

The projector has the on-screen menu that provides a variety of adjustment and settings.

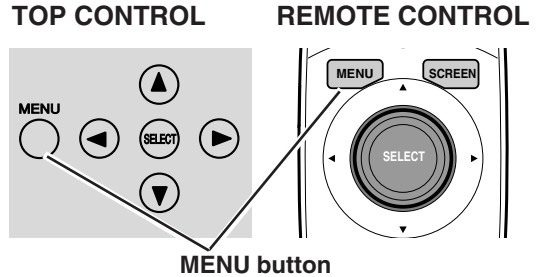

- 1 Display the on-screen menu by pressing the MENU button on the top control or the remote control. A main menu appears.

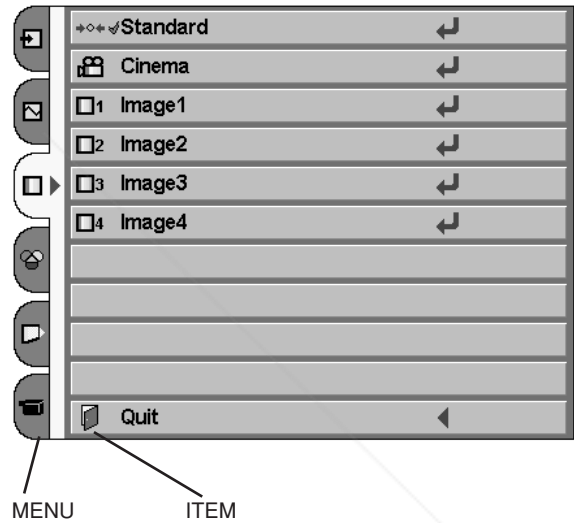

- 2 Select a menu from the main menu by pressing the POINT UP/DOWN button, and press the POINT RIGHT button to enter the sub-menu. (The selected icon turns yellow.)

### Main menu



- 3 Select an item by pressing the POINT UP/DOWN button, and activate the item that you have selected by the , , or  button.

- 4 Press the MENU button again to close the on-screen menu.



### Sub-menu

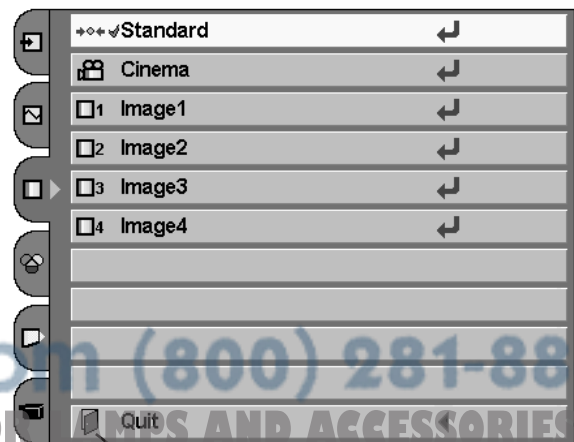







 **SELECT BUTTON**  
Press the SELECT button to activate the item that you have selected.

 **POINT LEFT BUTTON**  
Press the POINT LEFT button to go on or adjust values.







 **POINT RIGHT BUTTON**  
Press the POINT RIGHT button to go on or adjust values.

## Contents of Menus

### VIDEO MENUS

	<b>INPUT SOURCE SELECTION:</b> select input source either Video [Auto, Video, S-Video, (Y-Pb/Cb-Pr/Cr)] or Computer. (Refer to page 24, 25.)
	<b>VIDEO SYSTEM SELECTION:</b> select Video system from AUTO, PAL, SECAM, NTSC, NTSC4.43, PAL-M, PAL-N, 1080i, 1035i, 720p, 575p, 480p, 575i, 480i. (Refer to page 26.)
	<b>IMAGE LEVEL SELECTION:</b> select image level from Standard, Cinema, and Image 1 ~ 4. (Refer to page 27.)
	<b>IMAGE LEVEL ADJUSTMENT:</b> adjust Contrast / Brightness / Color / Tint / Color temp. / White balance (R/G/B) / Sharpness / Gamma / Auto grayscale / Auto fleshtone. (Refer to page 28, 29.)
	<b>SCREEN SIZE ADJUSTMENT:</b> set the screen size from Full, Zoom, or Normal. (Refer to page 30.)
	<b>SETTING:</b> change various settings; Language, Keystone, Blue back, Display, Menu position, Logo, Ceiling, Rear, Power management, Power off confirmation, Lamp mode, Remote control, and Lamp counter reset. (Refer to page 42.)

### COMPUTER MENUS

	<b>INPUT SOURCE SELECTION:</b> select input source either Computer or Video [Auto, Video, S-Video, (Y-Pb/Cb-Pr/Cr)]. (Refer to page 31.)
	<b>COMPUTER SYSTEM SELECTION:</b> select computer system available. (Refer to page 32.)
	<b>COMPUTER ADJUSTMENT:</b> select Auto PC Adj. or adjust Fine sync, Total dots, Horizontal, Vertical, Current mode, Clamp, Display area, Display area H, Display area V, Full screen, and use Reset, Mode free, and Store. (Refer to page 34-37.)
	<b>IMAGE LEVEL SELECTION:</b> select image level from Standard, Real, and Image 1 ~ 4. (Refer to page 38.)
	<b>IMAGE LEVEL ADJUSTMENT:</b> adjust Contrast / Brightness / Color temp. / White balance (R/G/B) / Sharpness / Gamma / Auto grayscale / Auto fleshtone. (Refer to page 39, 40.)
	<b>SCREEN SIZE ADJUSTMENT:</b> set the size from Normal, Full, True, and Digital zoom. (Refer to page 41.)
	<b>SETTING:</b> change various settings; Language, Keystone, Blue back, Display, Menu position, Logo, Ceiling, Rear, Power management, Power off confirmation, Lamp mode, Remote control, and Lamp counter reset. (Refer to page 42.)

# Video Input

## Input Source Selection (Direct Operation)

### INPUT BUTTON

You can select Video input or Computer input with the INPUT button. (The input source that is selected last is selected when the projector is turned on.)

If the projector cannot reproduce proper video source, select correct input source through menu operation on the next page.

### RGB Scart Input

To select RGB Scart 21-pin video input through the computer input terminal, follow the procedures described at the section "Input Source Selection" on page 31.

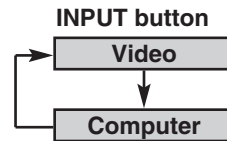

### TOP CONTROL

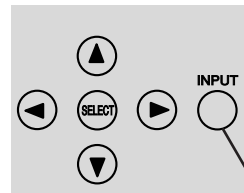

### REMOTE CONTROL

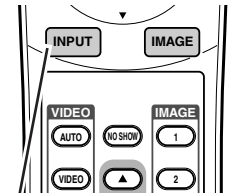

INPUT button

### AUTO / VIDEO / S-VIDEO / COMPO BUTTON

Press AUTO, VIDEO, S-VIDEO, or COMPO button on the remote control according to video input.

\*It is convenient for you to select the AUTO as the projector automatically detects incoming video signal, and adjust itself to optimize its performance.

#### AUTO

When selecting the AUTO, the projector automatically detects incoming video signal, and adjusts itself to optimize its performance. The projector selects connection in the following order:

- 1st Y-Pb/Cb-Pr/Cr
- 2nd S-VIDEO
- 3rd VIDEO

The Y-Pb/Cb-Pr/Cr has priority over the S-VIDEO. The S-VIDEO has priority over the VIDEO.

#### VIDEO

When video input signal is connected to VIDEO, select the Video.

#### S-VIDEO

When video input signal is connected to S-VIDEO, select the S-Video.

#### COMPO

When video input signal is connected to Y-Pb/Cb-Pr/Cr, select the COMPO.

### REMOTE CONTROL

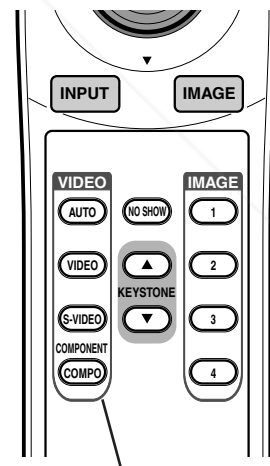

AUTO / VIDEO / S-VIDEO / COMPO button



FixYourDLP.com

Discount-Merchant.com (800) 281-8860

THE TRUSTED SOURCE FOR PROJECTOR LAMPS AND ACCESSORIES

## Input Source Selection (Menu Operation)

- 1** Press the MENU button, and the main menu appears. Select the Input Source Selection menu with the POINT UP/DOWN button, and then press the POINT RIGHT button to enter the sub-menu.

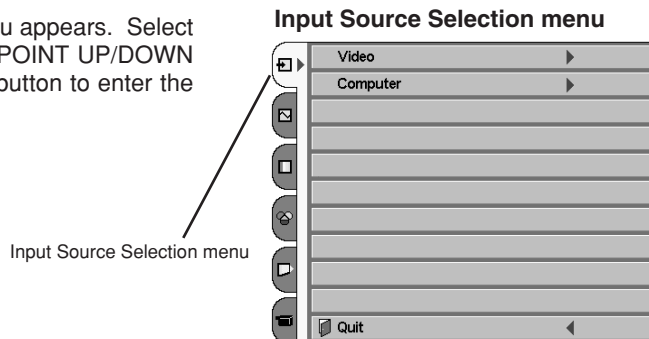

- 2** Choose the Video with the POINT UP/DOWN button and press the POINT RIGHT button. The source selection menu appears.

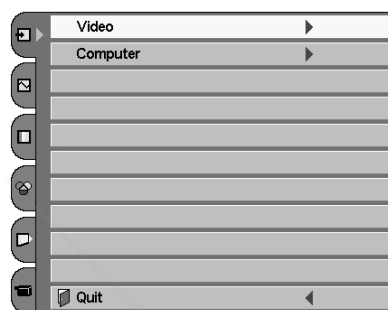

- 3** Move the pointer to the source that you want to select with the POINT UP/DOWN button, and press the SELECT button. Close the source selection menu.

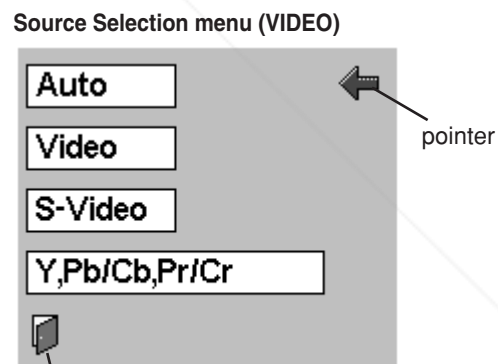

Close the source selection menu.



## Video System Selection (Video / S-Video)

- 1 Press the MENU button, and the main menu appears. Select the Video System Selection menu with the POINT UP/DOWN button, and then press the POINT RIGHT button to enter the sub-menu.

### Video System Selection menu (VIDEO / S-VIDEO)

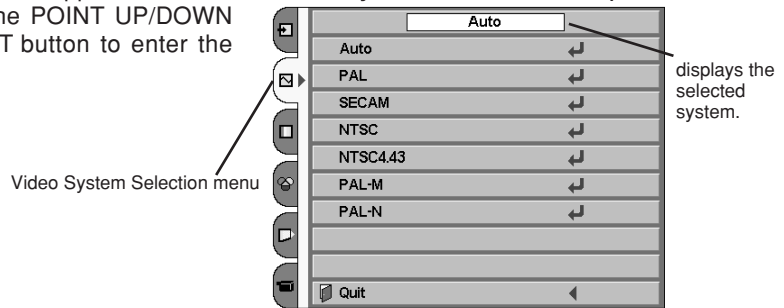

- 2 Choose the system that you want to select with the POINT UP/DOWN button, and then press the SELECT button to activate the item.

#### Auto

The projector automatically detects incoming video system, and adjusts itself to optimize its performance.

However, when video system is PAL-M or PAL-N, select either PAL-M or PAL-N manually.

#### PAL / SECAM / NTSC / NTSC4.43 / PAL-M / PAL-N

If the projector cannot reproduce proper video image, select a specific system among PAL, SECAM, NTSC, NTSC 4.43, PAL-M, and PAL-N.

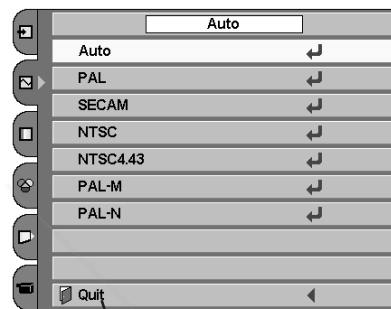

## Video System Selection (Y-Pb/Cb-Pr/Cr)

- 1 Press the MENU button, and the main menu appears. Select the Video System Selection menu with the POINT UP/DOWN button, and then press the POINT RIGHT button to enter the sub-menu.

### Video System Selection menu (Y-Pb/Cb-Pr/Cr)

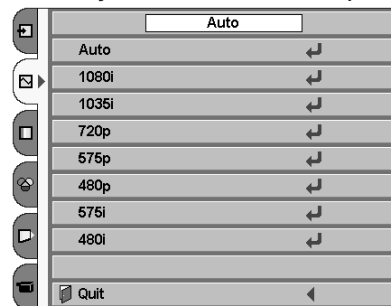

- 2 Choose the system that you want to select with the POINT UP/DOWN button, and then press the SELECT button to activate the item.

#### Auto

The projector automatically detects incoming video system, and adjusts itself to optimize its performance.

#### COMPONENT VIDEO SIGNAL FORMAT

If the projector cannot reproduce proper video image, select a specific component video system among 480i, 575i, 480p, 575p, 720p, 1035i, and 1080i.

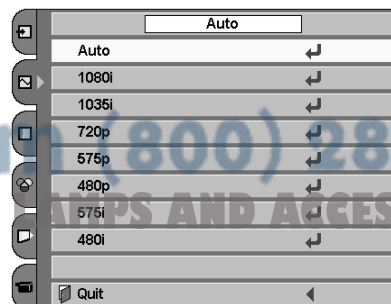

FixYourDIY.com

Sponsored by DM

Discount Merchant.com (800) 281-8860  
THE TRUSTED SOURCE FOR PROJECTOR PARTS AND ACCESSORIES

## Image Level Selection (Direct Operation)

Select the image level among Standard, Cinema, Image 1, Image 2, Image 3, and Image 4 by pressing the IMAGE button on the remote control. (See the next section "Image Level Selection (Menu Operation)" about each item.)

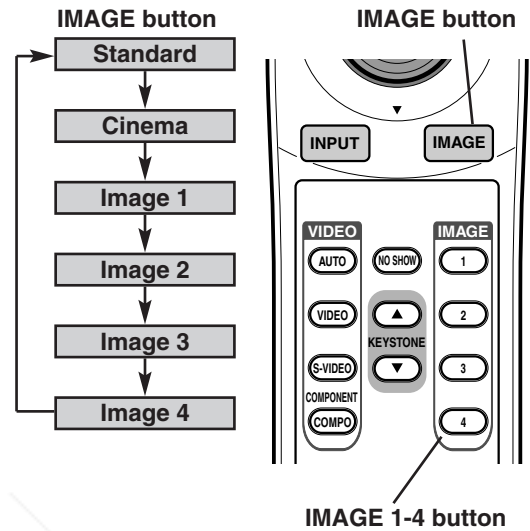

## Image Level Selection (Menu Operation)

- 1 Press the MENU button, and the main menu appears. Select the Image Level Selection menu with the POINT UP/DOWN button, and then press the POINT RIGHT button to enter the sub-menu.

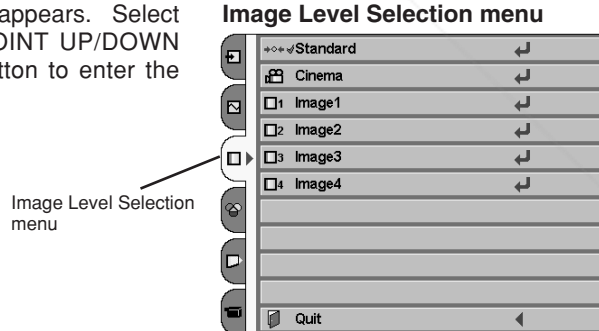

- 2 Choose the level that you want to set with the POINT UP/DOWN button, and then press the SELECT button to activate it.

Standard

Normal picture adjustment preset on this projector.

Cinema

Picture level adjusted for the picture with fine tone.

IMAGE 1~4

User preset picture adjustment in Image Level Adjustment menu (p28, 29).

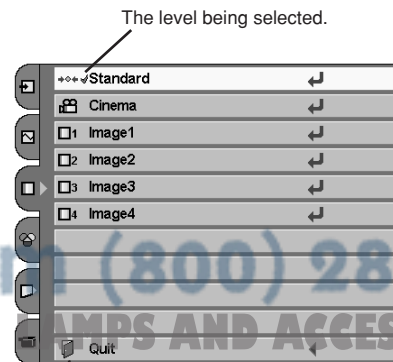

For Your DL Room

Sponsored by DM

Discount-Merchant.com (800) 281-8860  
THE TRUSTED SOURCE FOR PROJECTOR LAMPS AND ACCESSORIES

## Image Level Adjustment

**1** Press the MENU button, and the main menu appears. Select the Image Level Adjustment menu with the POINT UP/DOWN button, and then press the POINT RIGHT button to enter the sub-menu.

Image Level Adjustment menu

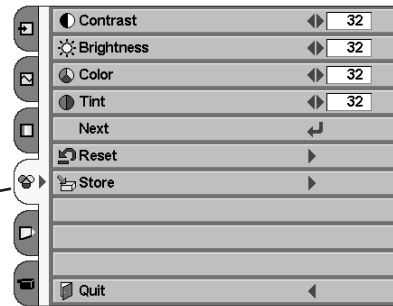

**2** Choose the item that you want to adjust with the POINT UP/DOWN button, and then press the POINT LEFT/RIGHT button to adjust each item. The items displayed in a line can be adjusted while you see the change of the image. Press the SELECT button to finish adjusting an item. The on-screen menu returns to the sub-menu.

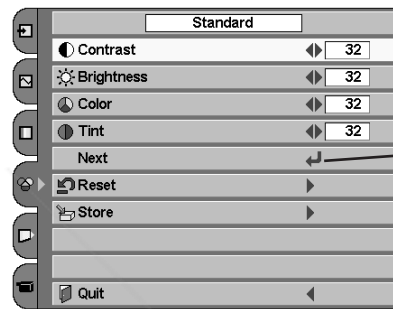

Press the SELECT button at this icon to display other items.



Press the SELECT button at this icon to close the item.

**3** To store the adjustment data, select the Store with the POINT UP/DOWN button and press the POINT RIGHT button.



To reset to previous level, select the Reset with the POINT UP/DOWN button and press the POINT RIGHT button. Select "Yes" with the SELECT button.



Select the Store.

**4** Choose one of the positions from Image Level 1 to 4 where you want to store with the POINT UP/DOWN button, and press the SELECT button. Select "Yes" with the SELECT button and close the menu by pressing the SELECT button at the Quit.



Discount-Merchant.com (800) 231-8860

THE TRUSTED SOURCE FOR PROJECTOR LAMPS AND ACCESSORIES

**NOTE**

All the items on the next page can be memorized in Image 1-4.

The items that you can adjust are the following:



#### Contrast

Press the POINT LEFT button to decrease contrast and the POINT RIGHT button to increase contrast. (From 0 to 63.)



#### Brightness

Press the POINT LEFT button to adjust image darker and the POINT RIGHT button to adjust image brighter. (From 0 to 63.)



#### Color

Press the POINT LEFT button to lighten color and the POINT RIGHT button to deepen color. (From 0 to 63.)



#### Tint

Press the POINT LEFT button or the POINT RIGHT button to obtain proper color. (From 0 to 63.)



#### Color temp.

Press the POINT LEFT button or the POINT RIGHT button for Color temp. level that you want to select. (XLow, Low, Mid, or High)



#### White balance (Red)

Press the POINT LEFT button to lighten red tone and the POINT RIGHT button to deepen red tone. (From 0 to 63.)



#### White balance (Green)

Press the POINT LEFT button to lighten green tone and the POINT RIGHT button to deepen green tone. (From 0 to 63.)

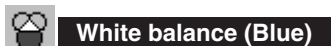

#### White balance (Blue)

Press the POINT LEFT button to lighten blue tone and the POINT RIGHT button to deepen blue tone. (From 0 to 63.)



#### Sharpness

Press the POINT LEFT button to soften the image and the POINT RIGHT button to sharpen the image. (From 0 to 15.)



#### Gamma

Press the POINT LEFT button or the POINT RIGHT button to obtain better balance of contrast. (From 0 to 15.)



#### Auto grayscale

When this function is "ON", it automatically enhances contrast of bright and dark part of image.



#### Auto fleshtone

When this function is "ON", it produces more vivid image according to image condition.



#### Reset

Reset all adjustment before the data is stored. (The Reset does not work for the stored data.)



#### Store

Store the adjustment data.



#### Quit

Close the Image Level Adjustment menu.

NOTE : Tint cannot be adjusted when the video system is PAL, SECAM, PAL-M or PAL-N.

## Screen Size Adjustment (Direct Operation)

Select the screen size among Full, Zoom, and Normal by pressing the SCREEN button on the remote control. (See the next section "Screen Size Adjustment (Menu Operation)" about each item.)

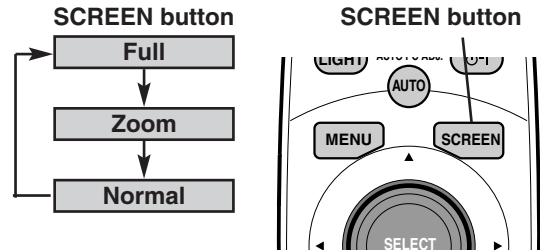

## Screen Size Adjustment (Menu Operation)

This projector has a picture screen resize function, which enables you to display the desirable image size.

- 1 Press the MENU button, and the main menu appears. Select the Screen Size Adjustment menu with the POINT UP/DOWN button, and then press the POINT RIGHT button to enter the sub-menu.

NOTE : The Screen Size Adjustment cannot be operated when "720p," "1035i," or "1080i" is selected in the Video System Selection menu (p26).

### Screen Size Adjustment menu



Screen Size Adjustment menu

- 2 Choose the item that you want to set with the POINT UP/DOWN button, and then press the SELECT button to activate it.

### Full

Provides an image to fit width of screen by expanding the image width uniformly. This function can be used for providing a squeezed video signal at wide video aspect ratio of 16 : 9.

When your video equipment (such as DVD) has 16 : 9 output mode, select 16 : 9 and select the Full on this Screen Size Adjustment menu to provide better quality.

### Zoom

Provides an image to fit screen size (16 : 9 aspect ratio) by expanding the image width and height uniformly. This function can be used for providing a letter box mode picture (4 : 3 aspect picture with black bar on the top and bottom edges) at wide video aspect of 16 : 9.

### Normal

Provides an image at the normal video aspect ratio of 4 : 3.

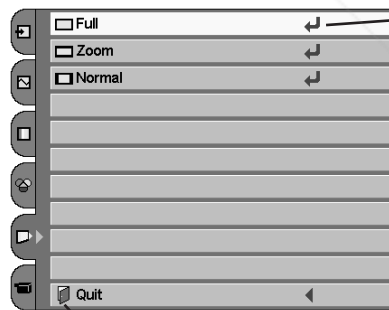

Press the SELECT button at this icon to activate the item.

Close the Screen Size Adjustment menu.

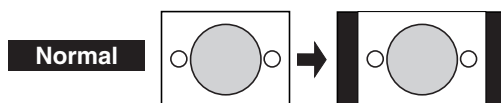
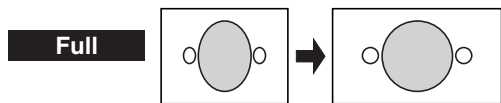

# Computer Input / (RGB Scart 21-Pin Video Input)

## Input Source Selection (Direct Operation)

### INPUT BUTTON

You can select Computer input or Video input with the INPUT button. (The input source that is selected last is selected when the projector is turned on.)

If the projector cannot reproduce proper image, select a correct input source through menu operation as shown below.

### RGB Scart Input

When RGB Scart 21-pin output is available in video equipment, connect the Scart connector to the "COMPUTER IN" on the projector with an optionally supplied Scart-VGA cable. It can reproduce higher resolution and quality of picture. (See page 51 for order.)

To select RGB Scart input, follow the procedures described below.

### Note

RGB Scart input (COMPUTER IN) can receive 575i only.

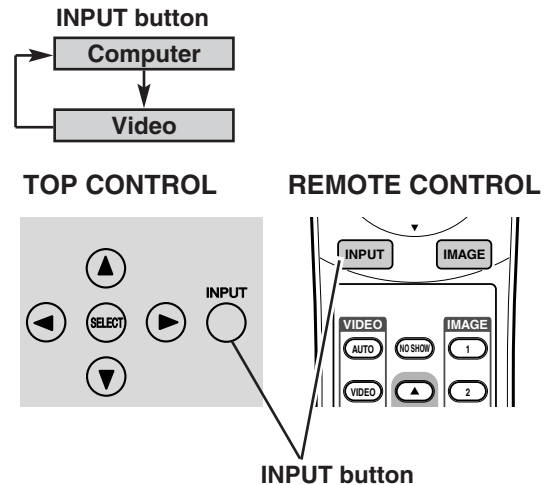

## Input Source Selection (Menu Operation)

- 1 Press the MENU button, and the main menu appears. Select the Input Source Selection menu with the POINT UP/DOWN button, and then press the POINT RIGHT button to enter the sub-menu.

Input Source Selection menu

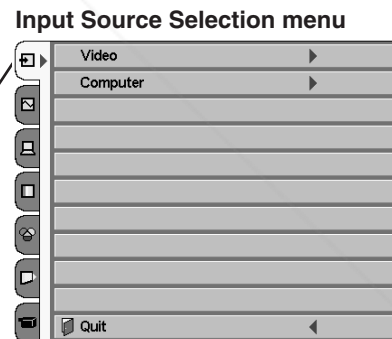

- 2 Choose the Computer with the POINT UP/DOWN button and press the POINT RIGHT button. The Source selection menu appears.

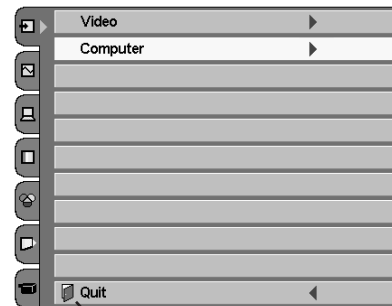

Close the Input Source Selection menu.

- 3 Move the pointer to the source that you want to select with the POINT UP/DOWN button, and press the SELECT button. To select computer input, select the RGB. To select RGB Scart 21-pin video input, select the RGB (Scart). Close the source selection menu.

### Source Selection menu

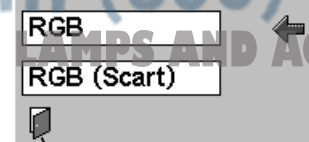

Close the source selection menu.

\*Select the RGB (Scart) only when connecting the projector with the Scart-VGA cable.



## Computer System Selection

This projector automatically tunes to most different types of computers based on VGA, SVGA, XGA, or SXGA in most cases (refer to “Compatible Computer System” on the next page). When selecting Computer, this projector automatically tunes to incoming signal and projects proper image without any special setting.

The projector displays one of the Auto, - - -, Mode 1/2/3/4/5, or the system provided in the projector.

### Auto

When the projector cannot recognize the connected system as computer system provided in this projector, Auto PC Adjustment function operates to adjust the projector and the message “Auto” is displayed on the System box. (Refer to p34.) Store the adjusted data by the Auto PC Adjustment function so as to use the system again. When the image is not provided properly, manual adjustment is required. (Refer to page 35, 36, and 37.)

### - - -

There is no signal input from the connected computer. Make sure the connection of the computer and the projector is set correctly. (Refer to the Troubleshooting section on page 47.)

### Mode 1

User preset adjustment in Computer Adjustment (Manual). Adjustment data can be stored Mode 1 - 5.

### SVGA 1

Computer systems provided in the projector. The projector chooses proper system and displays it.

\*Mode 1 and SVGA 1 are examples.

### Computer System Selection menu

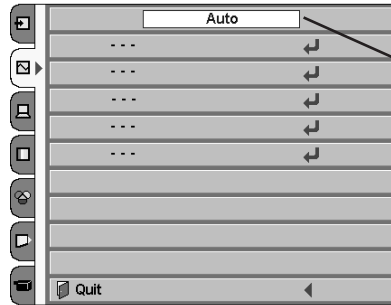

The System box displays the system being selected.

- Press the MENU button, and the main menu appears. Select the Computer System Selection menu with the POINT UP/DOWN button, and then press the POINT RIGHT button to enter the sub-menu.

Custom Mode (1-5) set in the Computer Adjustment menu. (p35-37)

### Computer System Selection menu

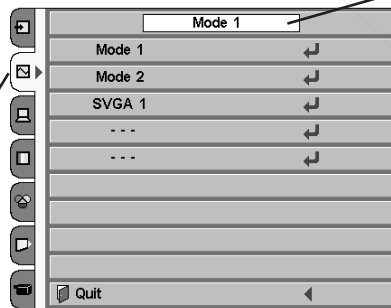

Computer System Selection menu

- Choose the system that you want to select with the POINT UP/DOWN button, and then press the SELECT button to activate the item.

Selected System

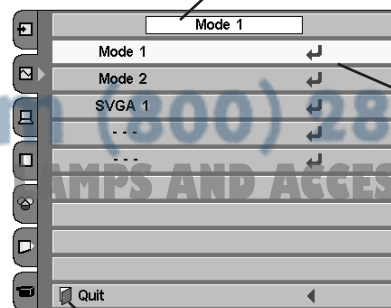

The systems displayed on the on-screen menu can be selected.

Close the Computer System Selection menu.

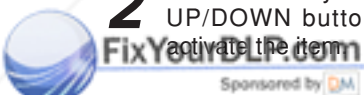

Discount-Merchant.com (800) 281-360 THE TRUSTED SOURCE FOR PROJECTOR CAMPS AND ACCESSORIES

**Compatible Computer System**

Basically this projector can accept the signal from all computers with the V, H-Frequency below mentioned and less than 100 MHz of Dot Clock.

ON-SCREEN DISPLAY	RESOLUTION	H-Freq. (kHz)	V-Freq. (Hz)	ON-SCREEN DISPLAY	RESOLUTION	H-Freq. (kHz)	V-Freq. (Hz)
VGA 1	640 x 480	31.47	59.88	XGA 4	1024 x 768	56.476	70.07
VGA 2	720 x 400	31.47	70.09	XGA 5	1024 x 768	60.31	74.92
VGA 3	640 x 400	31.47	70.09	XGA 6	1024 x 768	48.50	60.02
VGA 4	640 x 480	37.86	74.38	XGA 7	1024 x 768	44.00	54.58
VGA 5	640 x 480	37.86	72.81	XGA 8	1024 x 768	63.48	79.35
VGA 6	640 x 480	37.50	75.00	XGA 9	1024 x 768	36.00	87.17 (Interlace)
VGA 7	640 x 480	43.269	85.00	XGA 10	1024 x 768	62.04	77.07
MAC LC13	640 x 480	34.97	66.60	XGA 11	1024 x 768	61.00	75.70
MAC 13	640 x 480	35.00	66.67	XGA 12	1024 x 768	35.522	86.96 (Interlace)
RGB	————	15.625	50.00 (Interlace)	XGA 13	1024 x 768	46.90	58.20
RGB	————	15.734	60.00 (Interlace)	XGA 14	1024 x 768	47.00	58.30
SVGA 1	800 x 600	35.156	56.25	XGA 15	1024 x 768	58.03	72.00
SVGA 2	800 x 600	37.88	60.32	MAC 19	1024 x 768	60.24	75.08
SVGA 3	800 x 600	46.875	75.00	MAC 21	1152 x 870	68.68	75.06
SVGA 4	800 x 600	53.674	85.06	SXGA 1	1152 x 864	64.20	70.40
SVGA 5	800 x 600	48.08	72.19	SXGA 11	1152 x 900	61.20	65.20
SVGA 6	800 x 600	37.90	61.03	SXGA 13	1280 x 1024	50.00	86.00 (Interlace)
SVGA 7	800 x 600	34.50	55.38	SXGA 14	1280 x 1024	50.00	94.00 (Interlace)
SVGA 8	800 x 600	38.00	60.51	SXGA 17	1152 x 900	61.85	66.00
SVGA 9	800 x 600	38.60	60.31	SXGA 18	1280 x 1024	46.43	86.70 (Interlace)
SVGA 10	800 x 600	32.70	51.09	575p	————	31.25	50.00 (Progressive)
SVGA 11	800 x 600	38.00	60.51	720p	————	45.00	60.00 (Progressive)
MAC 16	832 x 624	49.72	74.55	1035i	————	33.75	60.00 (Interlace)
XGA 1	1024 x 768	48.36	60.00	1080i60	————	33.75	60.00 (Interlace)
XGA 2	1024 x 768	68.677	84.997	1080i50	————	28.125	50.00 (Interlace)
XGA 3	1024 x 768	60.023	75.03				

**NOTE**

Specifications are subject to change without notice.

This projector cannot display any resolution higher than 1280 X 1024. If your computer's screen resolution is higher than 1280 X 1024, reset the resolution to the lower before connecting projector.

The image data in other than 964 x 544 is modified to fit the screen size in initial mode.



**Discount-Merchant.com (800) 281-8860**  
**THE TRUSTED SOURCE FOR PROJECTOR LAMPS AND ACCESSORIES**

## Computer Adjustment (Auto) (Direct Operation)

Auto PC Adjustment function is provided to automatically adjust Fine sync, Total dots, Horizontal, and Vertical to conform to your computer. Auto PC Adjustment function can be operated as follows.

Press the AUTO PC ADJ. button on the remote control, and the function works.  
To store the adjustment data, follow the step 3 and 4 on page 35, 36.

### REMOTE CONTROL

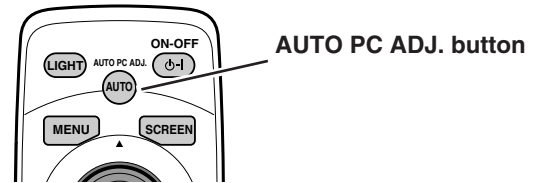

## Computer Adjustment (Auto) (Menu Operation)

- 1 Press the MENU button, and the main menu appears. Select the Computer Adjustment menu with the POINT UP/DOWN button, and then press the POINT RIGHT button to enter the sub-menu.

### Computer Adjustment menu

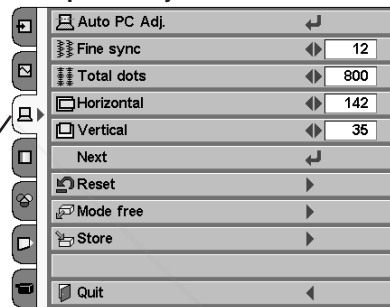

- 2 Choose the Auto PC Adj., and then press the SELECT button to activate it.

### Auto PC Adj.

adjusts Fine sync, Total dots, Horizontal, and Vertical to conform to your computer.

Selected Mode Shows status (Stored/Free) of the selected mode.

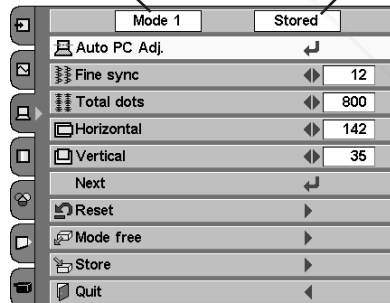

- 3 To store the adjustment parameters by Auto PC Adjustment, follow the step 3 and 4 on page 35, 36. Once the parameters are memorized, the setting can be done just by selecting Mode in the Computer System Selection menu.

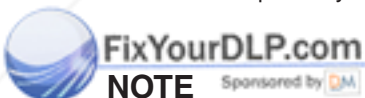

The Fine sync, Total dots, Horizontal, and Vertical of some computers cannot be fully adjusted with this Auto PC Adjustment function. When the image is not provided properly through this function, manual adjustments are required. (Refer to page 35-37)

The Auto PC Adjustment function cannot be operated when "720p (HDTV)", "1035i (HDTV)", or "1080i (HDTV)" is selected in the Computer System menu (p32).

The Computer Adjustment menu cannot be operated when "RGB" is selected in the Computer System menu or "RGB (Scart)" is selected in the Source Selection menu.

## Computer Adjustment (Manual)

This projector can automatically tune to the display signals from most personal computers currently distributed. However, some computers employ special signal formats which are different from the standard ones and may not be tuned by Multi-Scan system of this projector. If this happens, the projector cannot reproduce a proper image and the image may be recognized as a flickering picture, a non-synchronized picture, a non-centered picture, or a skewed picture.

This projector has a manual computer adjustment to enable you to precisely adjust several parameters to match with those special signal formats. This projector has 5 independent memory areas to memorize those parameters manually adjusted. This enables you to recall the setting for a specific computer whenever you use it.

- 1 Press the MENU button, and the main menu appears. Select the Computer Adjustment menu with the POINT UP/DOWN button, and then press the POINT RIGHT button to enter the sub-menu.

### Computer Adjustment menu

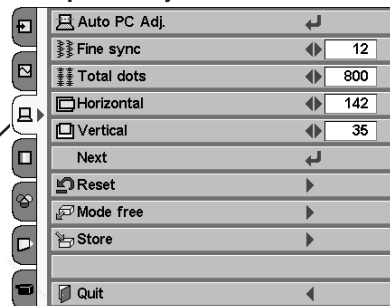

Computer Adjustment menu

- 2 Choose the item that you want to adjust, and then press the POINT LEFT/RIGHT button to adjust the value. The Fine sync and Total dots are displayed in a line. Press the SELECT button after adjusting them. The on-screen menu returns to the sub-menu.

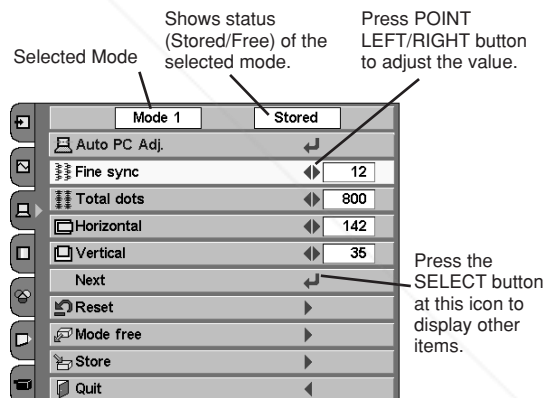

Press the SELECT button at this icon to close the item.

- 3 To store the adjustment parameters, select the Store with the POINT UP/DOWN button and press the POINT RIGHT button.

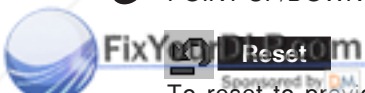
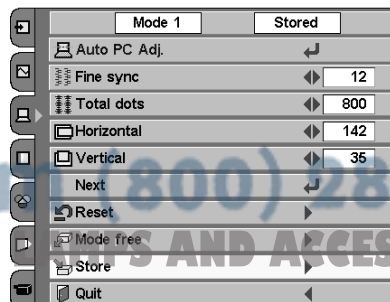

To reset to previous level, select the Reset with the POINT UP/DOWN button and press the POINT RIGHT button. Select "Yes" with the SELECT button.

DiscountMerchant.com (800) 281-8860  
 THE TRUSTED SOURCE FOR PROJECTOR PARTS AND ACCESSORIES

**4** Choose one of the positions from the Mode 1 to 5 where you want to store with the POINT UP/DOWN button, and press the SELECT button. Select "Yes" with the SELECT button and close the menu by pressing the SELECT button at the Quit.

### To store adjustment data.

Where to reserve ?

Mode 1	Stored	800	142	34	640	480
Mode 2	Free	800	143	34	640	480
Mode 3	Free	800	143	34	640	480
Mode 4	Free	800	143	34	640	480
Mode 5	Free	800	143	34	640	480

Vacant Mode      This Mode has parameters being stored.

**5** To clear the adjustment parameters previously set, select the Mode free with the POINT UP/DOWN button and press the POINT RIGHT button. Choose the mode that you want to clear with the POINT UP/DOWN button, and then press the SELECT button. Select "Yes" with the SELECT button and close the menu by pressing the SELECT button at the Quit.

### To clear adjustment data.

Which mode to free ?

Mode 1	Stored	800	142	34	640	480
Mode 2	Free	800	143	34	640	480
Mode 3	Free	800	143	34	640	480
Mode 4	Free	800	143	34	640	480
Mode 5	Free	800	143	34	640	480

Shows values of "Total dots," "Horizontal," "Vertical," "Display area H," and "Display area V."      Quit

The items that you can adjust are the following:



#### Fine sync

Adjust an image as necessary to eliminate flicker from the display. Press the POINT LEFT/RIGHT button to adjust value.(From 0 to 31.)



#### Total dots

The number of total dots in one horizontal period. Press the POINT LEFT/RIGHT button and adjust number to match your computer image.



#### Horizontal

Adjust horizontal picture position. Press the POINT LEFT/RIGHT button to adjust the position.



#### Vertical

Adjust vertical picture position. Press the POINT LEFT/RIGHT button to adjust the position.



#### Current mode

Press the POINT RIGHT button to show the information of the computer connected.

#### Current mode

H-Sync freq.	31.5
V-Sync freq.	60.0

Press the POINT RIGHT button at the Current mode icon to show the information of the computer connected.



#### Clamp

Adjust clamp level. When the image has a dark bar(s), try this adjustment.



Sponsored by DM

**Discount-Merchant.com (800) 281-8860**  
**THE TRUSTED SOURCE FOR PROJECTOR LAMPS AND ACCESSORIES**

 **Display area**

Select the area displayed with this projector. Select the resolution at the Display area dialog box.

NOTE : The Display area, Display area (H/V) and Full screen cannot be adjusted when “1035i (HDTV)” or “1080i (HDTV)” is selected in the Computer System Selection menu (p32).

**Display area**



Press the POINT RIGHT button at the Display area and the Display area dialog box appears.

 **Display area H**

Adjustment of horizontal area displayed with this projector. Press the POINT LEFT/RIGHT button to decrease/increase value to match the resolution of image.

 **Display area V**

Adjustment of vertical area displayed with this projector. Press the POINT LEFT/RIGHT button to decrease/increase value to match the resolution of image.

 **Full screen**

When this function is on, SXGA image is fully displayed at 4 : 3 aspect ratio. It is displayed at 5 : 4 aspect ratio with this function off.

NOTE : The Full screen cannot be selected after the Display area, Display area H, and Display area V are adjusted.

 **Reset**

Reset all adjustment before the data is stored. (The Reset does not work for the stored data.)

 **Mode free**

To clear the adjustment parameters previously set, select the Mode free and press the POINT RIGHT button. Choose the mode that you want to clear, and then press the SELECT button.

 **Store**

To store the adjustment parameters, select the Store and press the POINT RIGHT button. Choose one of the Mode 1 to 5, and press the SELECT button.

 **Quit**

Close the Computer Adjustment menu.

## Image Level Selection (Direct Operation)

Select the image level among Standard, Real, Image 1, Image 2, Image 3, and Image 4 by pressing the IMAGE button on the remote control. (See the next section "Image Level Selection (Menu Operation)" about each item.)

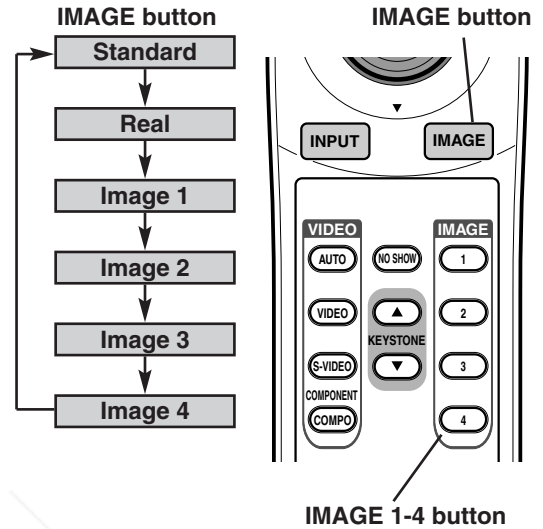

## Image Level Selection (Menu Operation)

**1** Press the MENU button, and the main menu appears. Select the Image Level Selection menu with the POINT UP/DOWN button, and then press the POINT RIGHT button to enter the sub-menu.

Image Level Selection menu

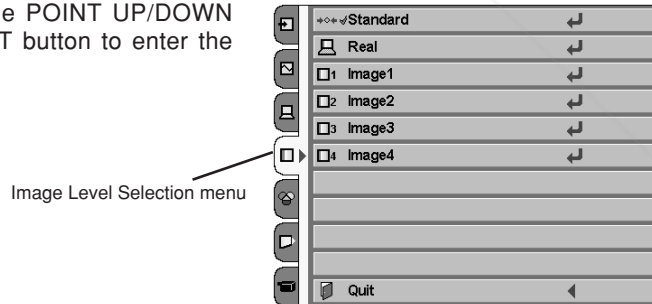

**2** Choose the level that you want to set with the POINT UP/DOWN button, and then press the SELECT button to activate it.



Normal picture adjustment preset on this projector.



Picture adjustment improved in reproduction of halftones. This adjustment is suitable for providing better image in brighter place.



User preset picture adjustment in the Image Level Adjustment menu (p39, 40).

The level being selected

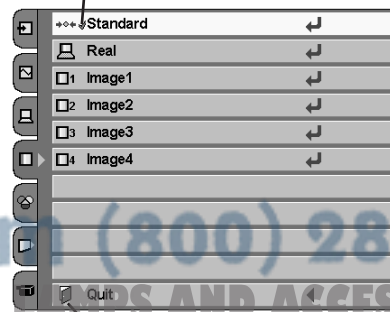

Close the Image Level Selection menu.



## Image Level Adjustment

- 1 Press the MENU button, and the main menu appears. Select the Image Level Adjustment menu with the POINT UP/DOWN button, and then press the POINT RIGHT button to enter the sub-menu.

Image Level Adjustment menu

Image Level Adjustment menu



- 2 Choose the item that you want to adjust with the POINT UP/DOWN button, and then press the POINT LEFT/RIGHT button to adjust each item. The items displayed in a line can be adjusted while you see the change of the image. Press the SELECT button to finish adjusting an item. The on-screen menu returns to the sub-menu.

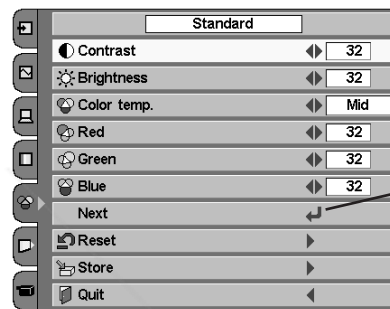

Press the SELECT button at this icon to display other items.



Press the SELECT button at this icon to close the item.

- 3 To store the adjustment data, select the Store with the POINT UP/DOWN button and press the POINT RIGHT button.



To reset to previous level, select the Reset with the POINT UP/DOWN button and press the POINT RIGHT button. Select "Yes" with the SELECT button.

Select the Store.

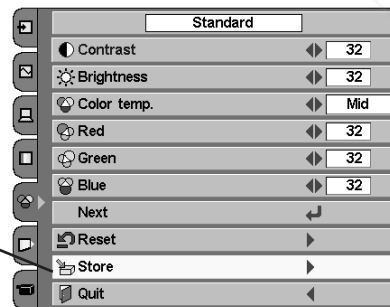

- 4 Choose one of the positions from the Image Level 1 to 4 where you want to store with the POINT UP/DOWN button, and press the SELECT button. Select "Yes" with the SELECT button and close the menu by pressing the SELECT button at the Quit.

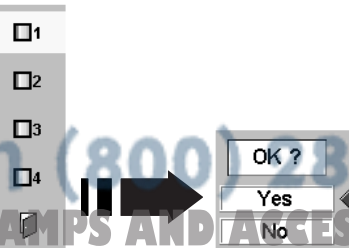

Discount-Merchant.com (800) 31-8860  
 THE TRUSTED SOURCE FOR PROJECTOR LAMPS AND ACCESSORIES

**NOTE**

All the items on the next page can be memorized in Image 1-4.

The items that you can adjust are the following:



## Contrast

Press the POINT LEFT button to decrease contrast and the POINT RIGHT button to increase contrast. (From 0 to 63.)



## Brightness

Press the POINT LEFT button to adjust image darker and the POINT RIGHT button to adjust image brighter. (From 0 to 63.)



## Color temp.

Press the POINT LEFT button or the POINT RIGHT button for Color temp. level that you want to select. (XLow, Low, Mid, or High)



## White balance (Red)

Press the POINT LEFT button to lighten red tone and the POINT RIGHT button to deepen red tone. (From 0 to 63.)



## White balance (Green)

Press the POINT LEFT button to lighten green tone and the POINT RIGHT button to deepen green tone. (From 0 to 63.)



## White balance (Blue)

Press the POINT LEFT button to lighten blue tone and the POINT RIGHT button to deepen blue tone. (From 0 to 63.)



## Sharpness

Press the POINT LEFT button to soften the image and the POINT RIGHT button to sharpen the image. (From 0 to 15.)



## Gamma

Press the POINT LEFT button or the POINT RIGHT button to obtain better balance of contrast. (From 0 to 15.)



## Auto grayscale

When this function is "ON", it automatically enhances contrast of bright and dark part of image.



## Auto fleshtone

When this function is "ON", it produces more vivid image according to image condition.



## Reset

Reset all adjustment before the data is stored. (The Reset does not work for the stored data.)



## Store

Store the adjustment data.



## Quit

Close the Image Level Adjustment menu.

## Screen Size Adjustment (Direct Operation)

Select the screen size among Normal, Full, True, and D.Zoom by pressing the SCREEN button on the remote control. (See the next section "Screen Size Adjustment (Menu Operation)" about each item.)

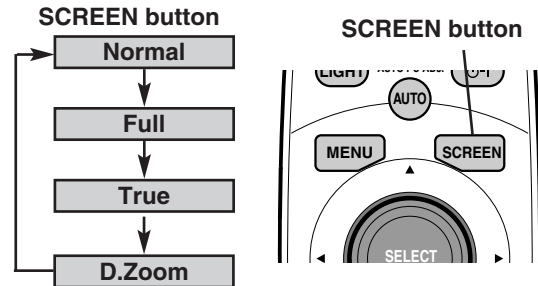

## Screen Size Adjustment (Menu Operation)

This projector has a picture screen resize function, which enables you to display the desirable image size.

- 1 Press the MENU button, and the main menu appears. Select the Screen Size Adjustment menu with the POINT UP/DOWN button, and then press the POINT RIGHT button to enter the sub-menu.

### Screen Size Adjustment menu

Screen Size Adjustment menu

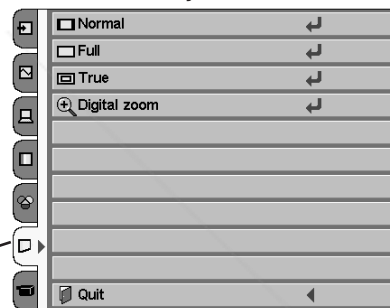

- 2 Choose the item that you want to set, and then press the SELECT button to activate it.

#### Normal

Provides an image at the normal video aspect ratio of 4 : 3.

#### Full

Provides an image to fit the horizontal size of the screen.

#### True

Provides image in its original size. When the original image size is larger than screen size (964 X 544), this projector enters "Digital zoom" automatically.

#### Digital zoom

When Digital zoom is selected, the on-screen menu disappears and the message "D.Zoom" is displayed. Press the SELECT button to expand the image. And press the POINT UP/DOWN/LEFT/RIGHT button(s) to pan the image. Panning function can work only when the original image is larger than screen size (964 X 544).

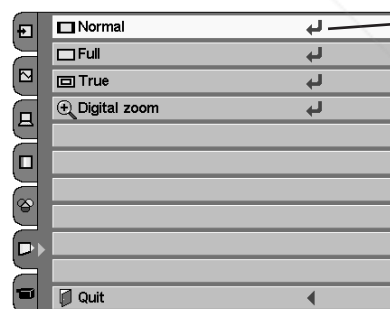

Press the SELECT button at this icon to activate the item.

### NOTE

The Screen Size Adjustment menu cannot be operated when "1035i (HDTV)", "1080i (HDTV)", or "720p(HDTV)" is selected in the Computer System menu (p32).

The True and Digital zoom cannot be selected when "RGB" is selected in the Computer System menu (p32).

Panning function may not operate properly if the computer system (Mode 1-5) stored in the Computer Adjustment menu is used.

## Setting

- 1 Press the MENU button, and the main menu appears. Select the Setting menu with the POINT UP/DOWN button, and then press the POINT RIGHT button to enter the sub-menu.

### Setting menu

Setting menu

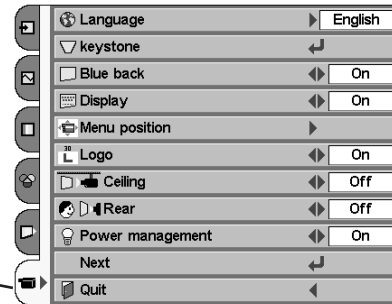

- 2 Choose the item that you want to set with the POINT UP/DOWN button, and then press the POINT LEFT/RIGHT button for each setting.

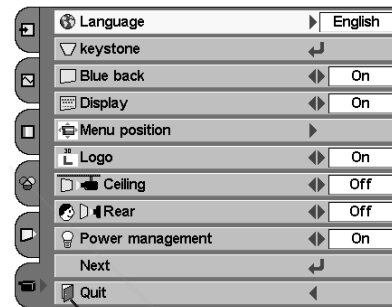

Close the Setting menu.

The items that you can adjust are the following:

#### Language

Language is available in English, German, French, Italian, Spanish, Portuguese, Dutch, Swedish, Russian, Chinese, Korean, and Japanese.

#### Keystone

When the image is distorted vertically, select the Keystone. The on-screen menu disappears and the Keystone dialog box is displayed. Correct keystone distortion by pressing the POINT UP/DOWN button. Refer to Keystone Adjustment on page 21.

#### Blue back

When this function is "On," the projector produces a blue image while input signal is not detected.

#### Display

This function decides whether to display On-Screen Displays.

On ... shows all the On-Screen Displays.

Off ... sets On-Screen Displays disappeared except;

- ON-SCREEN MENU
- "Power off?" message
- "No signal" message
- "Wait a moment!" message

#### Menu position

This function is used to change the position of the on-screen menu.



When pressing the SELECT button at the Language, the Language menu appears.

### Menu position



Move the position of the on-screen menu with the POINT buttons.

**30 Logo**

When this function is "On," the projector displays our logo when starting up.

**Ceiling**

When this function is "On," picture is top / bottom and left / right reversed. This function is used to project the image from a ceiling mounted projector.

**Rear**

When this function is "On," picture is left / right reversed. This function is used to project the image to a rear projection screen.

**Ceiling function**

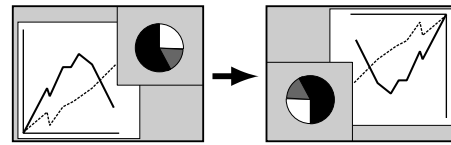

**Rear function**

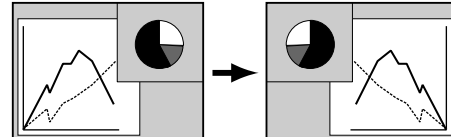

**Power management**

This function turns the Projection lamp off when this projector detects signal interruption and is not used for a certain period in order to reduce power consumption and maintain the lamp lifetime. (This projector is shipped with this function ON.) This function operates as follows;



Time left until the lamp goes off.

1. When any input signal is interrupted or no button is pressed for about 30 seconds, "No signal" and the counting down display appears (for 5 minutes).
2. After counting down for 5 minutes, the Projection lamp and the READY indicator are turned off. (Cooling Fans keep running.)
3. The READY indicator starts to flash after cooling down the Projection lamp for about 90 seconds (Power management mode). In this Power management mode, the Projection lamp is automatically turned on when the input signal is connected or the projector is operated with any button on the top control or on the remote control again.

**Power off confirmation**

The confirmation dialog box to turn off the projector is displayed with this function ON.

**Lamp mode**

When selecting the "💡", the projector operates with full brightness. When selecting the "💡", the projector turns to the Theater black mode that lowers the screen brightness, saves electricity, and extend the lamp life. The projector also operates silently.

**Remote control**

This projector has two different remote control codes: Code 1 and Code 2 (initial code) This switching function prevents remote control interference when operating several projectors or video equipment together. When operating the projector in "Code 1," both the projector and remote control must be switched to "Code 1."

**To change the code of the Projector;**

Set the remote control in the Setting menu to "Code 1."

**To change the code of the Remote Control;**

Press both the MENU and the IMAGE buttons on the remote control together for over 10 seconds.

After changing the code, make sure the remote control operates properly.

To return to the initial code (Code 2), repeat the steps above.

NOTE : When the batteries of the remote control are replaced, the remote control code automatically returns to the initial code (Code 2).

**Lamp counter reset**

This function is used to reset the Lamp Replace Counter. When replacing the Projection lamp, reset the Lamp Replace Counter by using this function. Refer to page 45 for operation.

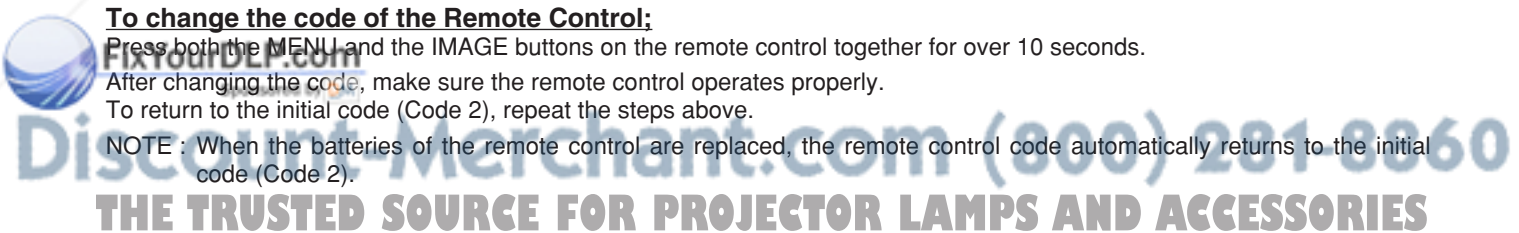

# Appendix

## Lamp Replacement

When the life of the projection lamp draws to an end, the LAMP REPLACE indicator lights yellow. When this indicator lights yellow, replace the projection lamp with a new one promptly.

This indicator lights yellow when the life of the projection lamp draws to an end. Replace the Projection Lamp with a new one.

### TOP CONTROL

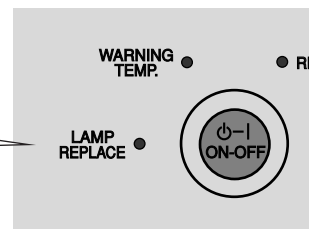

ALLOW A PROJECTOR TO COOL, FOR AT LEAST 45 MINUTES BEFORE YOU OPEN LAMP COVER. THE INSIDE OF A PROJECTOR CAN BECOME VERY HOT.



### CAUTION

FOR CONTINUED SAFETY, REPLACE WITH A LAMP ASSEMBLY OF THE SAME TYPE. DO NOT DROP A LAMP ASSEMBLY OR TOUCH A GLASS BULB! THE GLASS CAN SHATTER AND MAY CAUSE INJURY.

Follow these steps to replace the lamp assembly.

- 1** Turn off the projector and disconnect AC plug. Allow the projector to be cooled for at least 45 minutes.
- 2** To remove the Lamp cover, remove the screw with a screwdriver.
- 3** Remove 2 screws with a screwdriver and pull out the Lamp assembly by grasping the handle.
- 4** Replace the Lamp assembly with a new one and tighten the 2 screws back into position. Make sure that the Lamp assembly is set properly. Replace the Lamp cover and tighten the screw.
- 5** Connect the AC Power Cord to the projector and turn on the projector.
- 6** **Reset the Lamp Replace Counter.** Refer to "Lamp Replace Counter" on the next page.

**NOTE :** Do not reset the Lamp Replace Counter when the Projection lamp is not replaced.

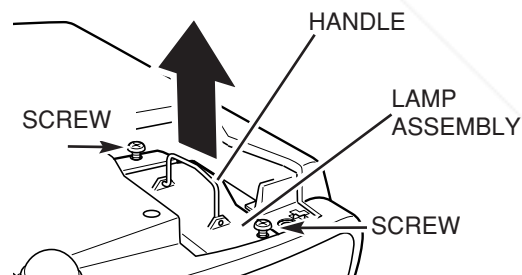
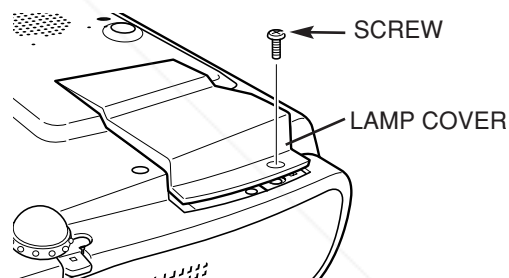

### ORDER REPLACEMENT LAMP

Replacement Lamp can be ordered through your dealer. When ordering a Projection Lamp, give the following information to the dealer.

- Model No. of your projector : PLV-Z1 / PLV-Z1BL
- Replacement Lamp Type No. : POA-LMP54

(Service Parts No. 610 302 5933)



## Lamp Replace Counter

Be sure to reset the Lamp Replace Counter after the Lamp assembly is replaced. After the Lamp Replace Counter is reset, the LAMP REPLACE indicator stops lighting.

- 1 Turn on the projector and press the MENU button. The main menu appears. Select the Setting menu with the POINT UP/DOWN button, and then press the POINT RIGHT button to enter the sub-menu.
- 2 Choose the Lamp counter reset with the POINT UP/DOWN button, and then press the SELECT button.
- 3 The message "Lamp replace counter reset?" is displayed. Select "Yes" with the SELECT button, and the other confirmation display appears. Select "Yes" with the SELECT button to reset.  
The LAMP REPLACE indicator stops lighting after the Lamp Replace Counter is reset.

### Setting menu

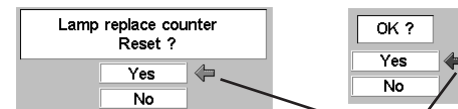
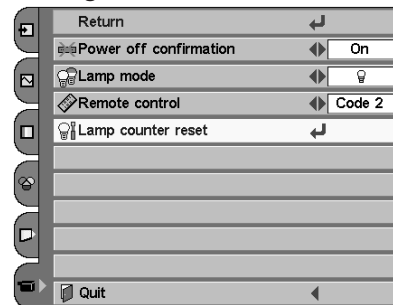

Select "Yes" to reset.

**NOTE :** Do not reset the Lamp Replace Counter before the Projection lamp is replaced.



## LAMP HANDLING PRECAUTIONS

This projector uses a high-pressure lamp which must be handled carefully and properly. Improper handling may result in accidents, injury, or create a fire hazard.

- Lamp lifetime may differ from lamp to lamp and according to the environment of use. There is no guarantee of the same lifetime for each lamp. Some lamps may fail or terminate their lifetime in a shorter period of time than other similar lamps.
- If the projector indicates that the lamp should be replaced, i.e., if the LAMP REPLACE INDICATOR lights up, replace the lamp with a new one IMMEDIATELY after the projector has cooled down. ( Follow carefully the instructions in the Lamp Replacement section of this manual. ) Continuous use of the lamp with the LAMP REPLACE INDICATOR lighted may increase the risk of lamp explosion.
- A Lamp may explode as a result of vibration, shock or degradation as a result of hours of use as its lifetime draws to an end. Risk of explosion may differ according to the environment or conditions in which the projector and lamp are being used.

### IF A LAMP EXPLODES, THE FOLLOWING SAFETY PRECAUTIONS SHOULD BE TAKEN.

If a lamp explodes, disconnect the projector's AC plug from the AC outlet immediately. Contact an authorized service station for a checkup of the unit and replacement of the lamp. Additionally, check carefully to ensure that there are no broken shards or pieces of glass around the projector or coming out from the cooling air circulation holes. Any broken shards found should be cleaned up carefully. No one should check the inside of the projector except those who are authorized trained technicians and who are familiar with projector service. Inappropriate attempts to service the unit by anyone, especially those who are not appropriately trained to do so, may result in an accident or injury caused by pieces of broken glass.



## Warning Temp. Indicator

The WARNING TEMP. indicator flashes red when an internal temperature of the projector exceeds the normal temperature. The indicator stops flashing when the temperature of the projector returns to normal. When the WARNING TEMP. indicator continues to flash, check the items listed below.

- 1 Ventilation slots of the projector may be blocked. In such an event, reposition the projector so that the Ventilation slots cannot be obstructed.
- 2 The Air filter may be clogged with dust particles. Clean the Air filter by following the section "Air Filter Care and Cleaning" below.
- 3 If the WARNING TEMP. indicator remains on after performing the above checks, the Cooling fans or the internal circuits may be malfunctioning. Contact service personnel from an authorized dealer or a service station.

### TOP CONTROL

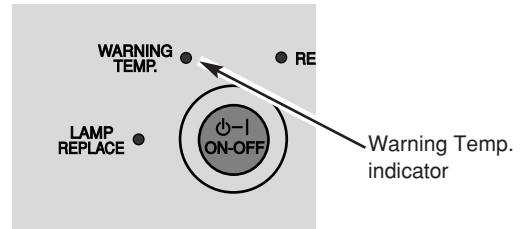

## Air Filter Care and Cleaning

The removable Air filter prevents dust from accumulating on the surface of the projection lens and projection mirror. Should the Air filter become clogged with dust particles, it will reduce the cooling fans' effectiveness and may result in internal heat build up and adversely affect the life of the projector. Clean the Air filter by following the steps below.

- 1 Turn off the projector, and disconnect AC Power Cord from the AC outlet.
- 2 Turn over the projector and remove the Air filter by pulling the latch upward.
- 3 Clean the Air filter with a brush or wash out dust and particles.
- 4 Replace the Air filter properly. Make sure that it is fully inserted.

Clean the Air intake vents with a vacuum cleaner at the same time.



### CAUTION

Do not operate the projector with the Air filter removed. Dust may accumulate on the LCD panels and the projection mirror degrading picture quality. Do not put small parts into the Air intake vents. It may result in malfunction of the projector.

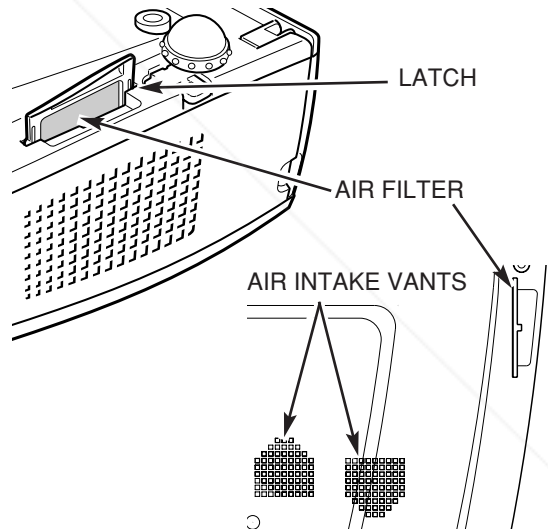

### Operating Environment

We recommend avoiding dusty/smoky environments when operating a projector.

When using under dusty or smoky conditions, dust may accumulate on the lens, liquid crystal panels, or optical elements inside the projector. This condition may degrade the quality of a projected image and the life of the projector. When the above symptoms are noticed, contact your authorized dealer or service station for proper cleaning.



FixYourDLP.com

Sponsored by DM

## Cleaning the Projection Lens

Follow these steps to clean the projection lens.

- 1 Apply a non-abrasive camera lens cleaner to a soft, dry cleaning cloth. Avoid using an excessive amount of cleaner. Abrasive cleaners, solvents or other harsh chemicals might scratch a surface.
- 2 Lightly wipe the Projection lens with a cleaning cloth.
- 3 When the projector is not in use, close the front cover.

## Troubleshooting











Before calling your dealer or service center for assistance, check the following:

- Make sure you have connected the projector to video equipment or your computer as described on page 17 and 18.
- Check cable connection. Verify that all video, computer, and power cord are properly connected.
- Verify that all power is switched on.
- When you are operating the projector with a computer and it does not produce an image, restart the computer.
- Select the other input source.

Problem:	Try these Solutions
<b>No power.</b>	<ul style="list-style-type: none"> <li>● Plug the projector into your AC outlet.</li> <li>● Make sure the MAIN ON/OFF switch is ON and that the READY indicator lights green.</li> <li>● Open the front cover.</li> <li>● Wait 90 seconds after the projector is turned OFF when turning the projector back on.</li> </ul> <p>NOTE : After pressing the POWER ON-OFF button to OFF, make sure the projector works as follows:</p> <ol style="list-style-type: none"> <li>1. The LAMP indicator lights bright and the READY indicator turns off.</li> <li>2. After 90 seconds, the READY indicator lights green again and the projector can be turned on by pressing the POWER ON-OFF button.</li> </ol> <ul style="list-style-type: none"> <li>● Check the WARNING TEMP. indicator. If the indicator flashes red, the projector cannot be turned on. (See the NOTE on page 19.)</li> <li>● Check the projection lamp. (Refer to page 44.)</li> </ul>
<b>Image is out of focus.</b>	<ul style="list-style-type: none"> <li>● Adjust focus of the projector.</li> <li>● Make sure the projection screen is at least 3.6' (1.1m) from the projector.</li> <li>● Check the projection lens to see if it needs cleaning.</li> </ul> <p>NOTE : Moving the projector from a cool temperature location to a warm temperature location may result in moisture condensation on the Projection Lens. In such an event, leave the projector OFF and wait until condensation disappears.</p>
<b>Picture is Left/Right reversed.</b>	<ul style="list-style-type: none"> <li>● Check Ceiling / Rear function. (See the Setting section on page 43.)</li> </ul>
<b>Picture is Top/Bottom reversed.</b>	<ul style="list-style-type: none"> <li>● Check Ceiling function. (See the Setting section on page 43.)</li> </ul>
<b>Some displays are not seen during the Operation.</b>	<ul style="list-style-type: none"> <li>● Check Display function.(See the Setting section on page 42.)</li> </ul>
<b>No image.</b>	<ul style="list-style-type: none"> <li>● Check the connection between video equipment / your computer and the projector.</li> <li>● Check the input source is selected properly.</li> <li>● Check NO SHOW function. (Refer to page 21.)</li> <li>● When turning the projector on, it takes about 30 seconds to display an image.</li> <li>● Check the system that you select is corresponding with video equipment or your computer.</li> <li>● Make sure the temperature is not out of the Operating Temperature (5°C ~ 35°C).</li> </ul>
<b>Remote Control does not work.</b>	<ul style="list-style-type: none"> <li>● Check the batteries.</li> <li>● Make sure there is nothing between the Infrared Remote Receiver and remote control.</li> <li>● Make sure you are not too far from the projector when using the remote control. Maximum operating range is 16.4' (5m).</li> <li>● Make sure the code of the remote control is set to conform to the projector. (See the Setting section on page 43.)</li> </ul>

## Indicators and Projector Condition

Check the Indicators for projector condition.

Indicator		Projector Condition
<b>LAMP</b>	 Red Light	The projector is OFF.
	 Dim Light	The projector is ON.
	 Off	The MAIN ON/OFF switch is off or AC Power Cord is disconnected.
<b>READY</b>	 Green Light	The projector is READY to be turned on.
	 Green Flashing	The projector is in the Power management mode.
	 Off	The projector is OFF. (The MAIN ON/OFF switch is off, AC Power Cord is disconnected, or the front cover is closed.)
<b>WARNING TEMP. (page 46)</b>	 Red Flashing	The temperature inside the projector is abnormally high. Flashing stops when the temperature returns to normal. The projector cannot be turned on until the indicator goes off.
	 Off	The projector is operating normally.
<b>LAMP REPLACE (page 44)</b>	 Yellow Light	The projection lamp needs to be replaced.
	 Off	The projector is operating normally.

If the problem still persists after following all operating instructions, contact the sales dealer where you purchased the projector or the service center. Give the model number and explain the difficulty. We will advise you how to obtain service.

## Technical Specifications

<b>Projector Type</b>	Multi-media Projector
<b>Dimensions (W x H x D)</b>	13.11" x 4.27" x 9.70" (333mm x 108.5mm x 246.5mm) (not including Adjustable Feet)
<b>Net Weight</b>	7.5lbs (3.4 kg)
<b>LCD Panel System</b>	0.7" Wide TFT Active Matrix type, 3 panels
<b>Panel Resolution</b>	964 x 544 dots
<b>Number of Pixels</b>	1,573,248 (964 x 544 x 3 panels)
<b>Color System</b>	PAL, SECAM, NTSC, NTSC4.43, PAL-M and PAL-N
<b>High Definition TV Signal</b>	480i, 480p, 575i, 575p, 720p, 1035i, and 1080i
<b>Scanning Frequency</b>	H-sync. 15 ~ 80 KHz, V-sync. 50 ~ 100 Hz
<b>Projection Image size (Diagonal)</b>	Adjustable from 30" to 200"
<b>Projection Lens</b>	F 2.03 ~ 2.34 lens with f 21.2 mm ~ 25.4 mm with manual zoom and focus
<b>Throw Distance</b>	3.6' ~ 19.7' (1.1 m ~ 6.0 m)
<b>Projection Lamp</b>	130 W
<b>Video Input Jacks</b>	RCA Type x 4 (Video, Y, Pb/Cb, Pr/Cr) and Mini DIN 4 pin x 1 (S-Video)
<b>Computer Input Terminal</b>	(VGA) HDB 15 Terminal x 1
<b>Feet Adjustment</b>	0° to 11.8°
<b>Voltage and Power Consumption</b>	AC 100 ~ 120 V (2.4 A Max. Ampere), 50 / 60 Hz (The U.S.A and Canada) AC 200 ~ 240 V (1.2 A Max. Ampere), 50 / 60 Hz (Continental Europe and The U.K.)
<b>Operating Temperature</b>	41 °F ~ 95 °F (5 °C ~ 35 °C)
<b>Storage Temperature</b>	14 °F ~ 140 °F (-10 °C ~ 60 °C)
<b>Remote Control</b>	Power Source : AA, UM3 or R06 Type x 2 Operating Range : 16.4' (5m) / ±30° Dimensions : 1.85" x 1.18" x 6.26" (47mm x 30mm x 159mm) Net Weight : 4.4oz (125g) (including batteries)
<b>Accessories</b>	Owner's Manual AC Power Cord Remote Control and Batteries Video Cable

- The specifications are subject to change without notice.
- LCD panels are manufactured to the highest possible standards. Even though 99.99% of the pixels are effective, a tiny fraction of the pixels (0.01% or less) may be ineffective by the characteristics of the LCD panels.



**WARNING** Prepared by DM

High voltages are used to operate this projector. Do not attempt to open the cabinet.

Discount-Merchant.com (800) 281-8860



This symbol on the nameplate means the product is Listed by Underwriters Laboratories Inc. It is designed and manufactured to meet rigid U.L. safety standards against risk of fire, casualty and electrical hazards.

## Dimensions

Unit : inch (mm)

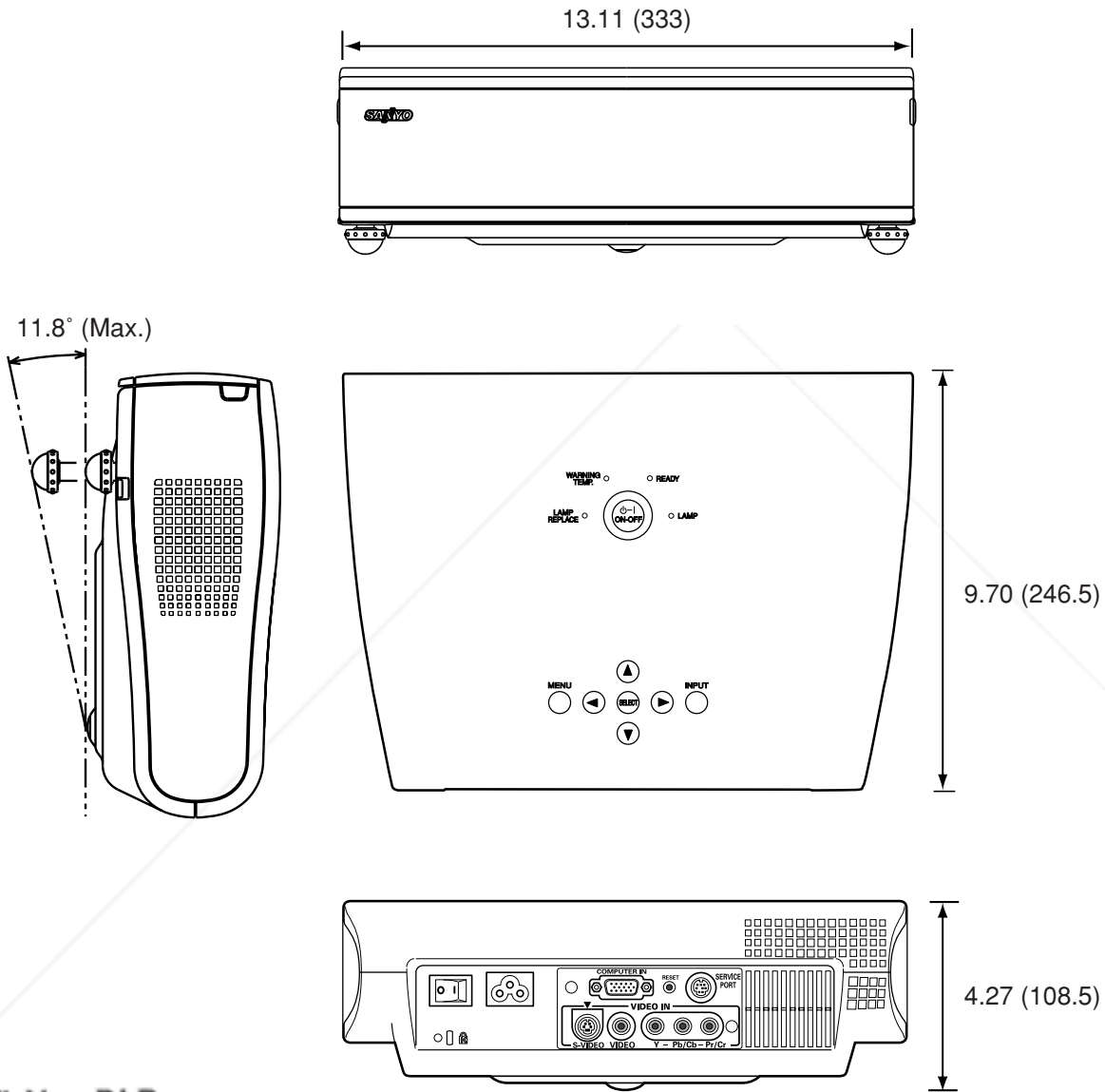

**Discount-Merchant.com (800) 281-8860**  
**THE TRUSTED SOURCE FOR PROJECTOR LAMPS AND ACCESSORIES**

## Configuration of Terminals

### COMPUTER INPUT TERMINAL (ANALOG)

Terminal : HDB15-PIN

#### Pin Configuration

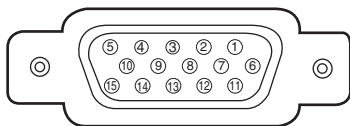

1	Red Input	9	No Connect
2	Green Input	10	Ground (Vert.sync.)
3	Blue Input	11	Sense 0
4	Sense 2	12	Sense 1
5	Ground (Horiz.sync.)	13	Horiz. sync.
6	Ground (Red)	14	Vert. sync.
7	Ground (Green)	15	Reserved
8	Ground (Blue)		

### SERVICE PORT CONNECTOR

Terminal : Mini DIN 8-PIN

\*This port is only used for service.

#### Pin Configuration

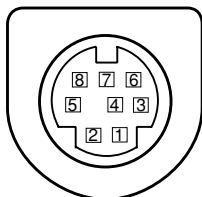

	Serial
1	R X D
2	-----
3	-----
4	GND
5	RTS / CTS
6	T X D
7	GND
8	GND

## Optional Parts

The parts listed below are optionally supplied. When ordering those parts, give name and Type No. of it to the sales dealer.

- MAC Adapter                      Type No. : POA-MACAP
- SCART-VGA Cable              Type No. : POA-CA-SCART  
(This cable is used for RGB Scart 21-pin output of video equipment.)

**THE TRUSTED SOURCE FOR PROJECTOR LAMPS AND ACCESSORIES**



**Discount-Merchant.com (800) 281-8860**  
**THE TRUSTED SOURCE FOR PROJECTOR LAMPS AND ACCESSORIES**

**SANYO**





# Disclaimer

This user manual is provided as a free service by FixYourDLP.com. FixYourDLP is in no way responsible for the content of this manual, nor do we guarantee its accuracy. FixYourDLP does not make any claim of copyright and all copyrights remain the property of their respective owners.

About FixYourDLP.com

FixYourDLP.com (<http://www.fixyourdpl.com>) is the World's #1 resource for media product news, reviews, do-it-yourself guides, and manuals.

Informational Blog: <http://www.fixyourdpl.com>

Video Guides: <http://www.fixyourdpl.com/guides>

User Forums: <http://www.fixyourdpl.com/forum>

FixYourDLP's Fight Against Counterfeit Lamps:

<http://www.fixyourdpl.com/counterfeits>

## Sponsors:

RecycleYourLamp.org – Free lamp recycling services for used lamps:

<http://www.recycleyourlamp.org>

Lamp Research - The trusted 3rd party lamp research company:

<http://www.lampresearch.com>

Discount-Merchant.com – The worlds largest lamp distributor:

<http://www.discount-merchant.com>



**FixYourDLP.com**

Sponsored by 