



# Disclaimer

This user manual is provided as a free service by FixYourDLP.com. FixYourDLP is in no way responsible for the content of this manual, nor do we guarantee its accuracy. FixYourDLP does not make any claim of copyright and all copyrights remain the property of their respective owners.

About FixYourDLP.com

FixYourDLP.com (<http://www.fixyourdpl.com>) is the World's #1 resource for media product news, reviews, do-it-yourself guides, and manuals.

Informational Blog: <http://www.fixyourdpl.com>

Video Guides: <http://www.fixyourdpl.com/guides>

User Forums: <http://www.fixyourdpl.com/forum>

FixYourDLP's Fight Against Counterfeit Lamps:

<http://www.fixyourdpl.com/counterfeits>

## Sponsors:

RecycleYourLamp.org – Free lamp recycling services for used lamps:

<http://www.recycleyourlamp.org>

Lamp Research - The trusted 3rd party lamp research company:

<http://www.lampresearch.com>

Discount-Merchant.com – The worlds largest lamp distributor:

<http://www.discount-merchant.com>



**FixYourDLP.com**

Sponsored by 

**BenQ**

MP512/MP513/MP522

Digital Projector

User Manual



**Discount-Merchant.com (800) 281-8860**

THE TRUSTED SOURCE FOR PROJECTOR LAMPS AND ACCESSORIES

**Welcome**

# Table of contents

<b>Important safety instructions .....</b>	<b>3</b>	Operating in a high altitude environment .....	38
<b>Introduction.....</b>	<b>7</b>	Personalizing the projector menu display .....	39
Projector features .....	7	Shutting down the projector .....	39
Shipping contents .....	8	Menu operation .....	40
Projector exterior view .....	9	<b>Maintenance.....</b>	<b>47</b>
Controls and functions .....	10	Care of the projector .....	47
<b>Positioning your projector .....</b>	<b>13</b>	Lamp information.....	48
Choosing a location.....	13	<b>Troubleshooting .....</b>	<b>54</b>
Obtaining a preferred projected image size.....	14	<b>Specifications .....</b>	<b>55</b>
<b>Connection .....</b>	<b>18</b>	Projector specifications.....	55
Connecting a computer or monitor... ..	18	Dimensions.....	56
Connecting Video source devices.....	20	Timing chart.....	56
<b>Operation .....</b>	<b>24</b>	<b>Warranty and Copyright information .....</b>	<b>58</b>
Starting up the projector .....	24	<b>Regulation statements .....</b>	<b>59</b>
Using the menus .....	25		
Utilizing the password function .....	26		
Switching input signal.....	28		
Adjusting the projected image.....	28		
Magnifying and searching for details .	30		
Selecting the aspect ratio .....	31		
Optimizing the image.....	32		
Setting the presentation timer .....	36		
Hiding the image .....	37		
Locking control keys .....	37		
Freezing the image .....	38		
Utilizing FAQ function .....	38		

# Important safety instructions

Your projector is designed and tested to meet the latest standards for safety of information technology equipment. However, to ensure safe use of this product, it is important that you follow the instructions mentioned in this manual and marked on the product.

## Safety Instructions

1. **Please read this manual before you operate your projector.** Save it for future reference.

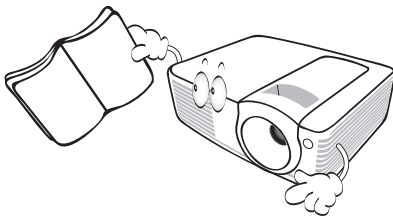

2. **Do not look straight at the projector lens during operation.** The intense light beam may damage your eyes.

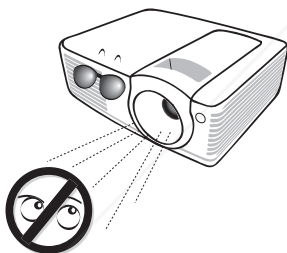

3. **Refer servicing to qualified service personnel.**

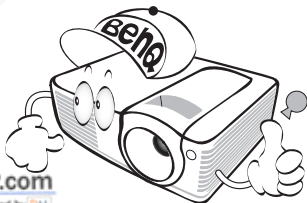

4. **Always open the lens shutter or remove the lens cap when the projector lamp is on.**

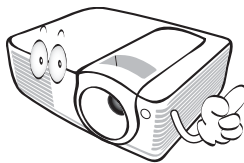

5. In some countries, the line voltage is NOT stable. This projector is designed to operate safely within a mains voltage between 100 to 240 volts AC, but could fail if power cuts or surges of  $\pm 10$  volts occur. **In areas where the mains voltage may fluctuate or cut out, it is recommended that you connect your projector through a power stabilizer, surge protector or uninterruptible power supply (UPS).**

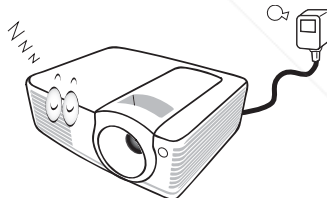

6. Do not block the projection lens with any objects when the projector is under operation as this could cause the objects to become heated and deformed or even cause a fire. To temporarily turn off the lamp, press **BLANK** on the projector or remote control.

## Safety Instructions (Continued)

7. The lamp becomes extremely hot during operation. Allow the projector to cool for approximately 45 minutes prior to removing the lamp assembly for replacement.

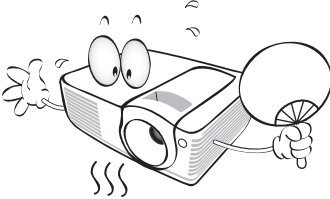

8. Do not operate lamps beyond the rated lamp life. Excessive operation of lamps beyond the rated life could cause them to break on rare occasions.

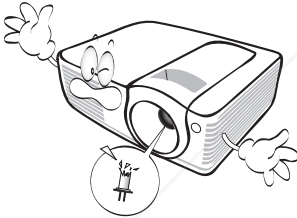

9. Never replace the lamp assembly or any electronic components unless the projector is unplugged.

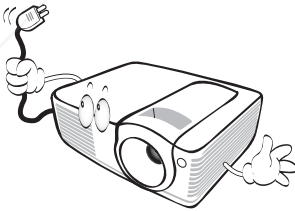

10. Do not place this product on an unstable cart, stand, or table. The product may fall, sustaining serious damage.

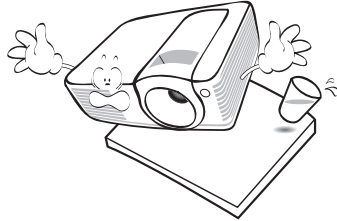

11. Do not attempt to disassemble this projector. There are dangerous high voltages inside which may cause death if you should come into contact with live parts. The only user serviceable part is the lamp which has its own removable cover. Under no circumstances should you ever undo or remove any other covers. Refer servicing only to suitably qualified professional service personnel.

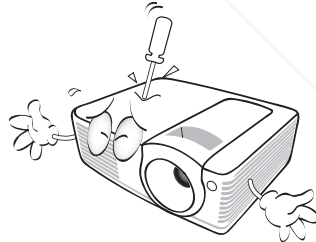

12. When the projector is under operation, you may sense some heated air and odor from its ventilation grill. It is a normal phenomenon and not a product defect.

## Safety Instructions (Continued)

13. Do not place this projector in any of the following environments.
- Space that is poorly ventilated or confined. Allow at least 50 cm clearance from walls and free flow of air around the projector.
  - Locations where temperatures may become excessively high, such as the inside of a car with all windows rolled up.
  - Locations where excessive humidity, dust, or cigarette smoke may contaminate optical components, shortening the projector's life span and darkening the image.

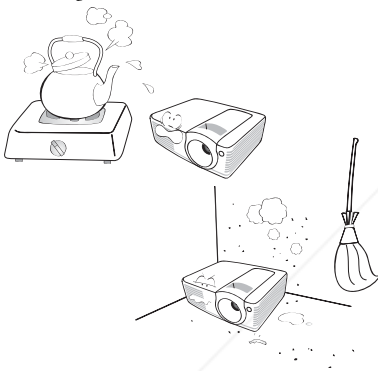

- Locations near fire alarms
- Locations with an ambient temperature above 40°C / 104°F
- Locations where the altitudes are higher than 3000 m (10000 feet).

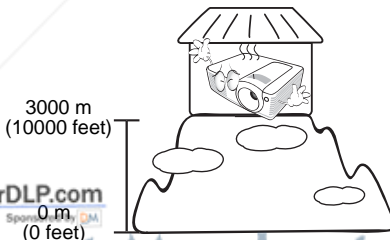

14. Do not block the ventilation holes.
- Do not place this projector on a blanket, bedding or any other soft surface.
  - Do not cover this projector with a cloth or any other item.
  - Do not place inflammables near the projector.

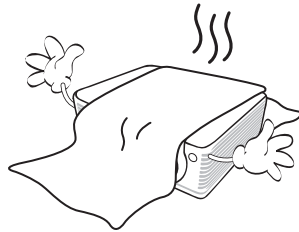

If the ventilation holes are seriously obstructed, overheating inside the projector may result in a fire.

15. Always place the projector on a level, horizontal surface during operation.
- Do not use if tilted at an angle of more than 10 degrees left to right, nor at angle of more than 15 degrees front to back. Using the projector when it is not fully horizontal may cause a malfunction of, or damage to, the lamp.

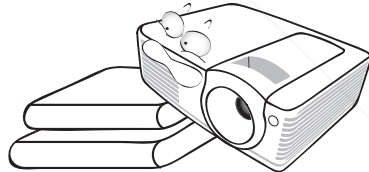

16. Do not stand the projector on end vertically. Doing so may cause the projector to fall over, causing injury or resulting in damage to the projector.

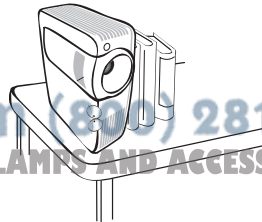

## Safety Instructions (Continued)

17. Do not step on the projector or place any objects upon it. Besides probable physical damage to the projector, doing so may result in accidents and possible injury.

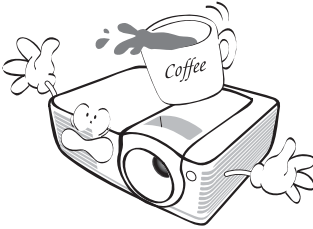

18. Do not place liquids near or on the projector. Liquids spilled into the projector may cause it to fail. If the projector does become wet, disconnect it from the power supply's wall socket and call BenQ to have the projector serviced.

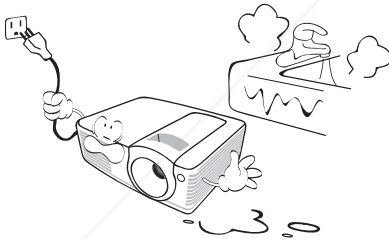

19. This product is capable of displaying inverted images for ceiling mount installation.



**Use only BenQ's Ceiling Mount Kit for mounting the projector and ensure it is securely installed.**

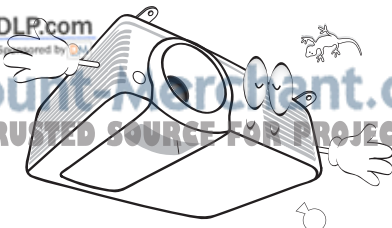

### **Ceiling mounting the projector**

We want you to have a pleasant experience using your BenQ projector, so we need to bring this safety matter to your attention to prevent possible damage to person and property.

If you intend to mount your projector on the ceiling, we strongly recommend that you use a proper fitting BenQ projector ceiling mount kit and that you ensure it is securely and safely installed.

If you use a non-BenQ brand projector ceiling mount kit, there is a safety risk that the projector may fall from the ceiling due to an improper attachment through the use of the wrong gauge or length screws.

You can purchase a BenQ projector ceiling mount kit from the place you purchased your BenQ projector. BenQ recommends that you also purchase a separate Kensington lock compatible security cable and attach it securely to both the Kensington lock slot on the projector and the base of the ceiling mount bracket. This will perform the secondary role of restraining the projector should its attachment to the mounting bracket become loose.

# Introduction

## Projector features

The projector integrates high-performance optical engine projection and a user-friendly design to deliver high reliability and ease of use.

The projector offers the following features.

- Wall color correction allowing projection on surfaces of several predefined colors
- Quick auto search speeding up the signal detecting process
- Selectable password protected function
- Up to 11 sets of picture modes providing multiple choices for different projection purposes
- 3D color management allowing color adjustments to your liking
- Selectable quick cooling function makes the projector cool in a shorter time
- Presentation timer for better control of time during presentations
- One-key auto-adjustment to display the best picture quality
- Digital keystone correction to correct distorted images
- Adjustable color balance control for data/video display
- High brightness projection lamp
- Ability to display 16.7 million colors
- Multi-language On-Screen Display (OSD) menus
- Switchable normal and economic modes to reduce the power consumption
- Component HDTV compatibility (YPbPr)

The MP513/MP522 also offers the following features.

- High quality manual zoom lens

- ☞ • **The apparent brightness of the projected image will vary depending on the ambient lighting conditions, selected input signal contrast/brightness settings, and is directly proportional to projection distance.**
- **The lamp brightness will decline over time and may vary within the lamp manufacturers specifications. This is normal and expected behavior.**



**Discount-Merchant.com (800) 281-8860**  
**THE TRUSTED SOURCE FOR PROJECTOR LAMPS AND ACCESSORIES**



# Shipping contents

Carefully unpack and verify that you have all of the items shown below. If any of these items are missing, please contact your place of purchase.

## Standard accessories

 The supplied accessories will be suitable for your region, and may differ from those illustrated.

\*The warranty card and safety manual are only supplied in some specific regions. Please consult your dealer for detailed information.

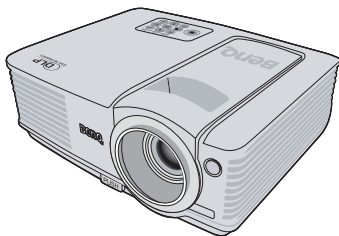

Projector

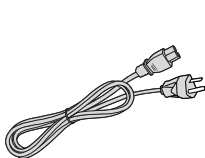

Power cord

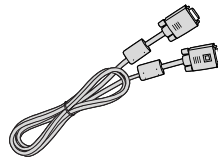

VGA cable



Quick start guide



User manual CD



Warranty card\*



Safety manual\*



**Pull the tab before using the remote control.**



Remote control with battery

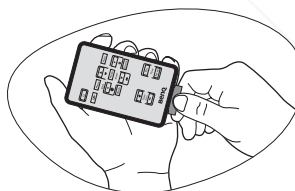

## Optional accessories



- 1. Spare lamp kit
- 2. Ceiling mount kit

- 3. Presentation Plus
- 4. RS-232 cable

**Discount-Merchant.com (800) 281-8860**  
THE TRUSTED SOURCE FOR PROJECTOR LAMPS AND ACCESSORIES

# Projector exterior view

## Front/upper side

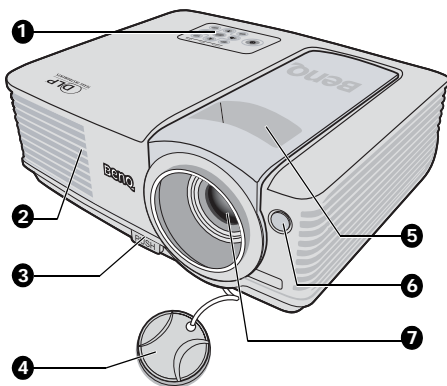

1. External control panel  
(See "Projector" on page 10 for details.)
2. Vent (heated air exhaust)
3. Quick-release button
4. Lens cover
5. Focus ring and Zoom ring  
(Zoom ring is not available with the MP512.)
6. Front IR remote sensor
7. Projection lens

## Rear/lower side

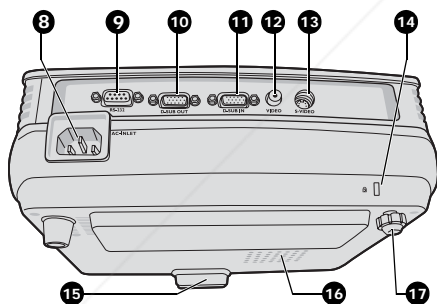

8. AC power cord inlet
9. RS-232 control port
10. RGB signal output socket
11. RGB (PC)/Component video  
(YPbPr/ YCbCr) signal input socket
12. Video input socket
13. S-Video input socket
14. Kensington anti-theft lock slot
15. Quick-release foot
16. Lamp cover
17. Rear adjuster foot

# Controls and functions

## Projector

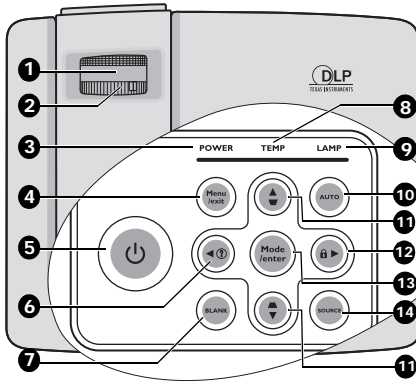

- 1. Focus ring**  
Adjusts the focus of the projected image. See ["Fine-tuning the image size and clarity" on page 29](#) for details.
- 2. Zoom ring**  
Adjusts the size of the image. See ["Fine-tuning the image size and clarity" on page 29](#) for details. (Zoom ring is not available with the MP512.)
- 3. POWER indicator light**  
Lights up or flashes when the projector is under operation. See ["Indicators" on page 53](#) for details.
- 4. Menu/Exit**  
Turns on the On-Screen Display (OSD) menu. Goes back to previous OSD menu, exits and saves menu settings. See ["Using the menus" on page 25](#) for details.
- 5. Power**  
Toggles the projector between standby mode and on. See ["Starting up the projector" on page 24](#) and ["Shutting down the projector" on page 39](#) for details.
- 6. Left/ ?**  
Starts the FAQ function. See ["Utilizing FAQ function" on page 38](#) for details.
- 7. BLANK**  
Used to hide the screen picture. See ["Hiding the image" on page 37](#) for details.
- 8. TEMPerature indicator light**  
Lights up red if the projector's temperature becomes too high. See ["Indicators" on page 53](#) for details.
- 9. LAMP indicator light**  
Indicates the status of the lamp. Lights up or flashes when the lamp has developed a problem. See ["Indicators" on page 53](#) for details.
- 10. AUTO**  
Automatically determines the best picture timings for the displayed image. See ["Auto-adjusting the image" on page 29](#) for details.
- 11. Keystone/Arrow keys ( ▾ / ▲ Up, ▢ / ▼ Down)**  
Manually corrects distorted images resulting from an angled projection. See ["Correcting keystone" on page 30](#) for details.
- 12. Right/ Lock**  
Activates panel key lock. See ["Locking control keys" on page 37](#) for details. When the On-Screen Display (OSD) menu is activated, the #6, #11, and #12 keys are used as directional arrows to select the desired menu items and to make adjustments. See ["Using the menus" on page 25](#) for details.
- 13. Mode/Enter**  
Selects an available picture setup mode. See ["Selecting a picture mode" on page 32](#) for details. Enacts the selected On-Screen Display (OSD) menu item. See ["Using the menus" on page 25](#) for details.
- 14. SOURCE**  
Displays the source selection bar. See ["Switching input signal" on page 28](#) for details.

# Remote control

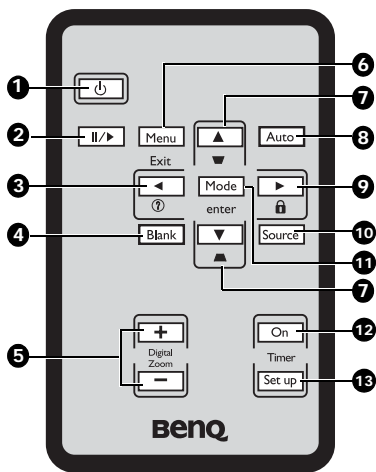

1. **Power**  
Toggles the projector between standby mode and on. See "[Starting up the projector](#)" on page 24 and "[Shutting down the projector](#)" on page 39 for details.
2. **Freeze**  
Freezes the projected image. See "[Freezing the image](#)" on page 38 for details.
3. **Left/ ?**  
Starts the FAQ function. See "[Utilizing FAQ function](#)" on page 38 for details.
4. **BLANK**  
Used to hide the screen picture. See "[Hiding the image](#)" on page 37 for details.
5. **Digital Zoom keys (+, -)**  
Magnifies or reduces the projected picture size. See "[Magnifying and searching for details](#)" on page 30 for details.
6. **Menu/Exit**  
Turns on the On-Screen Display (OSD) menu. Goes back to previous OSD menu, exits and saves menu settings. See "[Using the menus](#)" on page 25 for details.

7. **Keystone/Arrow keys ( ▭ / ▲ Up, ▭ / ▼ Down)**

Manually corrects distorted images resulting from an angled projection. See "[Correcting keystone](#)" on page 30 for details.

8. **AUTO**

Automatically determines the best picture timings for the displayed image. See "[Auto-adjusting the image](#)" on page 29 for details.

9. **Right/ Lock**

Activates panel key lock. See "[Locking control keys](#)" on page 37 for details. When the On-Screen Display (OSD) menu is activated, the #3, #7 and #9 keys are used as directional arrows to select the desired menu items and to make adjustments. See "[Using the menus](#)" on page 25 for details.

10. **SOURCE**

Displays the source selection bar. See "[Switching input signal](#)" on page 28 for details.

11. **Mode/Enter**

Depending upon which input signal is selected, selects an available picture setup mode. See "[Selecting a picture mode](#)" on page 32 for details.

Enacts the selected On-Screen Display (OSD) menu item. See "[Using the menus](#)" on page 25 for details.

12. **Timer On**

Activates or displays an on-screen timer based on your own timer setting. See "[Setting the presentation timer](#)" on page 36 for details.

13. **Timer Setup**

Enters presentation timer setting directly. See "[Setting the presentation timer](#)" on page 36 for details.

## Remote control effective range

Infra-Red (IR) remote control sensor is located on the front of the projector. The remote control must be held at an angle within 30 degrees perpendicular to the projector's IR remote control sensor to function correctly. The distance between the remote control and the sensor should not exceed 8 meters (~ 26 feet).

Make sure that there are no obstacles between the remote control and the IR sensor on the projector that might obstruct the infra-red beam.

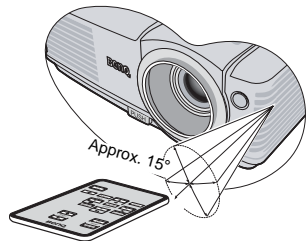

## Replacing the remote control battery

1. Pull out the battery holder.

 Please follow the illustrated instructions. Push and hold the locking arm while pulling out the battery holder.

2. Insert the new battery in the holder. Note the positive polarity should face outward.
3. Push the holder into the remote control.



- **Avoid excessive heat and humidity.**
- **There may be battery damage if the battery is incorrectly replaced.**
- **Replace only with the same or equivalent type recommended by the battery manufacturer.**
- **Dispose of the used battery according to the battery manufacturer's instructions.**
- **Never throw a battery into a fire. There may be danger of an explosion.**
- **If the battery is dead or if you will not be using the remote control for a long time, remove the battery to prevent damage to the remote control from possible battery leakage.**

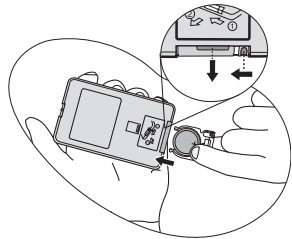

# Positioning your projector

## Choosing a location

Your room layout or personal preference will dictate which installation location you select. Take into consideration the size and position of your screen, the location of a suitable power outlet, as well as the location and distance between the projector and the rest of your equipment.

Your projector is designed to be installed in one of four possible installation locations:

### 1. Front Table

Select this location with the projector placed near the floor in front of the screen. This is the most common way to position the projector for quick setup and portability.

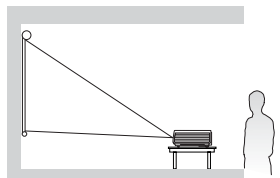

### 2. Front Ceiling

Select this location with the projector suspended upside-down from the ceiling in front of the screen.

Purchase the BenQ Projector Ceiling Mounting Kit from your dealer to mount your projector on the ceiling.

Set **Front Ceiling** in the **SYSTEM SETUP: Basic > Projector Position** menu after you turn the projector on.

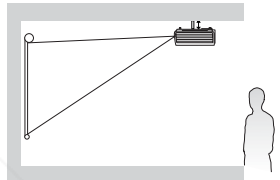

### 3. Rear Table

Select this location with the projector placed near the floor behind the screen.

Note that a special rear projection screen is required.

Set **Rear Table** in the **SYSTEM SETUP: Basic > Projector Position** menu after you turn the projector on.

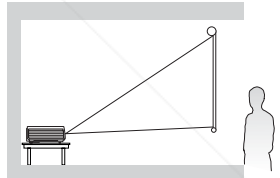

### 4. Rear Ceiling

Select this location with the projector suspended upside-down from the ceiling behind the screen.

Note that a special rear projection screen and the BenQ Projector Ceiling Mounting Kit are required for this installation location.

Set **Rear Ceiling** in the **SYSTEM SETUP: Basic > Projector Position** menu after you turn the projector on.

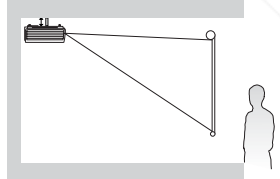

# Obtaining a preferred projected image size

The distance from the projector lens to the screen, the zoom setting (if available), and the video format each factors in the projected image size.

4:3 is the native aspect ratio of this projector. To be able to project a complete 16:9 (widescreen) aspect ratio image, the projector can resize and scale a widescreen image to the projector's native aspect width. This will result in a proportionally smaller height equivalent to 75% of the projector's native aspect height.

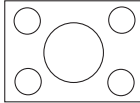

4:3 aspect image in a 4:3 aspect display area

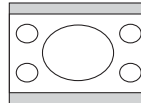

16:9 aspect image scaled to a 4:3 aspect display area

Thus, a 16:9 aspect image will not utilize 25% of the height of a 4:3 aspect image displayed by this projector. This will be seen as darkened (unlit) bars along the top and bottom (vertical 12.5% height respectively) of the 4:3 projection display area whenever displaying a scaled 16:9 aspect image in the vertical center of the 4:3 projection display area.

The projector should always be placed horizontally level (like flat on a table), and positioned directly perpendicular (90° right-angle square) to the horizontal center of the screen. This prevents image distortion caused by angled projections (or projecting onto angled surfaces).

The modern digital projector does not project directly forward (like older style reel-to-reel film projectors did). Instead, digital projectors are designed to project at a slightly upward angle above the horizontal plane of the projector. This is so that they can be readily placed on a table and will project forward and upwards onto a screen positioned so that the bottom edge of the screen is above the level of the table (and everyone in the room can see the screen).

If the projector is mounted on a ceiling, it must be mounted upside-down so that it projects at a slightly downward angle.

You can see from the diagram on page 16, that this type of projection causes the bottom edge of the projected image to be vertically offset from the horizontal plane of the projector. When ceiling mounted, this refers to the top edge of the projected image.

If the projector is positioned further away from the screen, the projected image size increases, and the vertical offset also increases proportionately.

When determining the position of the screen and projector, you will need to account for both the projected image size and the vertical offset dimension, which are directly proportional to the projection distance.

BenQ has provided a table of 4:3-aspect-ratio screen sizes to assist you in determining the ideal location for your projector. Refer to "[MP513/MP522 projection dimensions](#)" on page 16 or "[MP512 projection dimensions](#)" on page 17 depending on the projector you are using. There are two dimensions to consider, the perpendicular horizontal distance from the center of the screen (projection distance), and the vertical offset height of the projector from the horizontal edge of the screen (offset).

## How to determine the position of the projector for a given screen size

1. Select your screen size.
2. Refer to the table and find the closest match to your screen size in the left columns labelled "[4:3 screen diagonal](#)". Using this value, look across this row to the right to find the corresponding average distance from screen value in the column labelled "[Average](#)". This is the projection distance.
3. On that same row, look across to the right column and make note of the "[Vertical offset in mm](#)" value. This will determine the final vertical offset placement of the projector in relation to the edge of the screen.
4. The recommended position for the projector is aligned perpendicular to the horizontal center of the screen, at the distance from the screen determined in step 2 above, and offset by the value determined in step 3 above.

For example, if you are using a 120-inch screen, the average projection distance is 4846 mm and with a vertical offset of 183 mm.

If you place the projector in a different position (to that recommended), you will have to tilt it down or up to center the image on the screen. In these situations, some image distortion will occur. Use the Keystone function to correct the distortion. See "[Correcting keystone](#)" on [page 30](#) for details.

## How to determine the recommended screen size for a given distance

This method can be used for situations where you have purchased this projector and would like to know what screen size will fit in your room.

The maximum screen size is limited by the physical space available in your room.

1. Measure the distance between the projector and where you want to position the screen. This is the projection distance.
2. Refer to the table and find the closest match to your measurement in the average distance from screen column labelled "[Average](#)". If the min and max values are available on the table, check that your measured distance is between the min and max distances listed on either side of the average distance value.
3. Using this value, look across that row to the left to find the corresponding screen diagonal listed in that row. That is the projected image size of the projector at that projection distance.
4. On that same row, look across to the right column and make note of the "[Vertical offset in mm](#)" value. This will determine the final placement of the screen in relation to the horizontal plane of the projector.

For example, if your measured projection distance was 4.5 m (4500 mm), the closest match in the "[Average](#)" column is 4362 mm. Looking across this row shows that a 108-inch screen is required.

 FixYourDPE.com  
**Discount-Merchant.com (800) 281-8860**  
THE TRUSTED SOURCE FOR PROJECTOR LAMPS AND ACCESSORIES



# MP513/MP522 projection dimensions

Refer to "Dimensions" on page 56 for the center of lens dimensions of this projector before calculating the appropriate position.

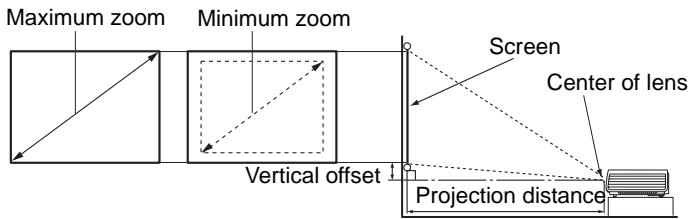

4:3 screen diagonal			Recommended projection distance from screen in mm			Vertical offset in mm
Feet	Inches	mm	Min length (with max. zoom)	Average	Max length (with min. zoom)	
4	48	1219	1846	1938	2031	73
	59	1500	2271	2385	2498	90
5	60	1524	2308	2423	2538	91
	72	1829	2769	2908	3046	110
7	79	2000	3028	3180	3331	120
	84	2134	3231	3392	3554	128
8	96	2438	3692	3877	4062	146
	98	2500	3786	3975	4164	150
9	108	2743	4154	4362	4569	165
	118	3000	4543	4770	4997	180
10	120	3048	4615	4846	5077	183
	138	3500	5300	5565	5830	210
12	144	3658	5538	5815	6092	219
	157	4000	6057	6360	6663	240
15	180	4572	6923	7269	7615	274
	197	5000	7571	7950	8328	300
18	216	5486	8308	8723	9138	329
	236	6000	9085	9540	9994	360
25	300	7620	11538	12115	12692	457

There is 3% tolerance among these numbers due to optical component variations. BenQ recommends that if you intend to permanently install the projector, you should physically test the projection size and distance using the actual projector in situ before you permanently install it so as to make allowance for this projector's optical characteristics. This will help you determine the exact mounting position so that it best suits your installation location.

FixYourVideo.com

**Discount-Merchant.com (800) 281-8860**  
 THE TRUSTED SOURCE FOR PROJECTOR LAMPS AND ACCESSORIES

# MP512 projection dimensions

Refer to "Dimensions" on page 56 for the center of lens dimensions of this projector before calculating the appropriate position.

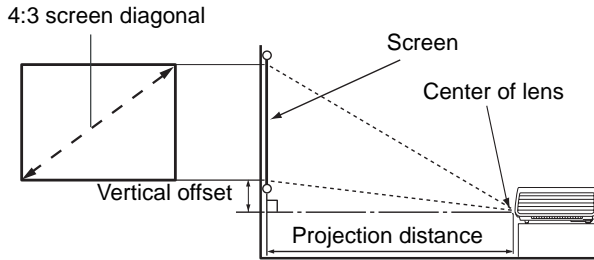

4:3 screen diagonal			Recommended projection distance from screen in mm	Vertical offset in mm
Feet	Inches	mm		
			Average	
4	48	1219	1920	73
	59	1500	2362	90
5	60	1524	2400	91
	72	1829	2880	110
6	79	2000	3150	120
	84	2134	3360	128
8	96	2438	3840	146
	98	2500	3937	150
9	108	2743	4320	165
	118	3000	4724	180
10	120	3048	4800	183
	138	3500	5512	210
12	144	3658	5760	219
	157	4000	6299	240
15	180	4572	7200	274
	197	5000	7874	300
18	216	5486	8640	329
	236	6000	9449	360
25	300	7620	12000	457

There is 3% tolerance among these numbers due to optical component variations. BenQ recommends that if you intend to permanently install the projector, you should physically test the projection size and distance using the actual projector in situ before you permanently install it, so as to make allowance for this projector's optical characteristics. This will help you determine the exact mounting position so that it best suits your installation location.



Sponsored by DM

**Discount-Merchant.com (800) 281-8860**  
**THE TRUSTED SOURCE FOR PROJECTOR LAMPS AND ACCESSORIES**

# Connection

When connecting a signal source to the projector, be sure to:

1. Turn all equipment off before making any connections.
2. Use the correct signal cables for each source.
3. Ensure the cables are firmly inserted.

 In the connections shown below, some cables may not be included with the projector (see "Shipping contents" on page 8). They are commercially available from electronics stores.

## Connecting a computer or monitor

### Connecting a computer

The projector provides a VGA input socket that allows you to connect it to both IBM® compatibles and Macintosh® computers. A Mac adapter is needed if you are connecting legacy version Macintosh computers.

#### To connect the projector to a notebook or desktop computer:

1. Take the supplied VGA cable and connect one end to the D-Sub output socket of the computer.
2. Connect the other end of the VGA cable to the **D-SUB IN** signal input socket on the projector.

The final connection path should be like that shown in the following diagram:

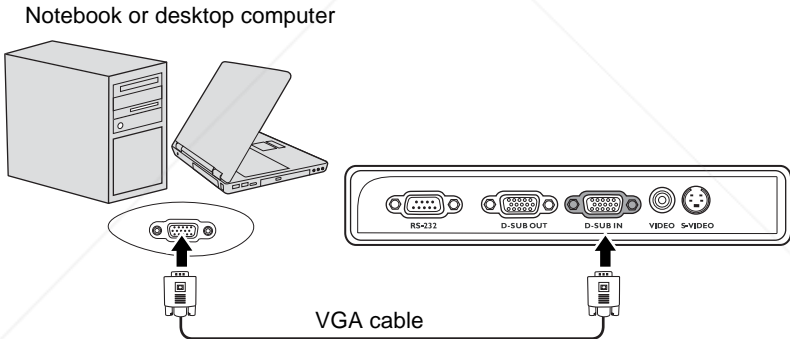

 Many notebooks do not turn on their external video ports when connected to a projector. Usually a key combo like FN + F3 or CRT/LCD key turns the external display on/off. Locate a function key labeled CRT/LCD or a function key with a monitor symbol on the notebook. Press FN and the labeled function key simultaneously. Refer to your notebook's documentation to find your notebook's key combination.



**Discount-Merchant.com (800) 281-8860**  
THE TRUSTED SOURCE FOR PROJECTOR LAMPS AND ACCESSORIES

## Connecting a monitor

If you want to view your presentation close-up on a monitor as well as on the screen, you can connect the **D-SUB OUT** signal output socket on the projector to an external monitor with a VGA cable following the instructions below:

### To connect the projector to a monitor:

1. Connect the projector to a computer as described in "[Connecting a computer](#)" on page 18.
2. Take a suitable VGA cable (only one supplied) and connect one end of the cable to the D-Sub input socket of the video monitor.  
Or if your monitor is equipped with a DVI input socket, take a VGA to DVI-A cable and connect the DVI end of the cable to the DVI input socket of the video monitor.
3. Connect the other end of the cable to the **D-SUB OUT** socket on the projector.

The final connection path should be like that shown in the following diagram:

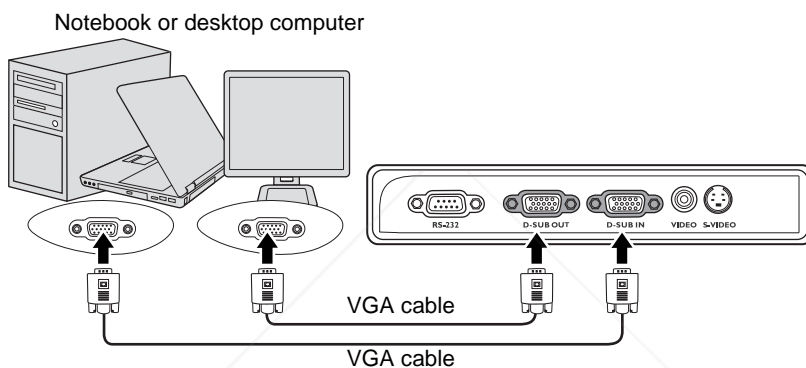

- The D-Sub output only works when an appropriate D-Sub input is made to the projector.
- If you wish to use this connection method when the projector is in standby mode, make sure the Standby D-Sub Output function is turned on in the SYSTEM SETUP: Advanced menu. See "[Standby D-Sub Output](#)" on page 45 for details.

# Connecting Video source devices

You can connect your projector to various Video source devices that provide any one of the following output sockets:

- Component Video
- S-Video
- Video (composite)

You need only connect the projector to a Video source device using just one of the above connecting methods, however each provides a different level of video quality. The method you choose will most likely depend upon the availability of matching terminals on both the projector and the Video source device as described below:

## Best video quality

The best available video connection method is Component Video (not to be confused with composite Video). Digital TV tuner and DVD players output Component Video natively, so if available on your devices, this should be your connection method of choice in preference to (composite) Video.

See "[Connecting a Component Video source device](#)" on page 21 for how to connect the projector to a component video device.

## Better video quality

The S-Video method provides a better quality analog video than standard composite Video. If you have both composite Video and S-Video output terminals on your Video source device, you should elect to use the S-Video option.

See "[Connecting an S-Video source device](#)" on page 22 for how to connect the projector to an S-Video device.

## Least video quality

Composite Video is an analog video and will result in a perfectly acceptable, but less than optimal result from your projector, being the least video quality of the available methods described here.

See "[Connecting a composite Video source device](#)" on page 23 for how to connect the projector to a composite Video device.



**Discount-Merchant.com (800) 281-8860**  
**THE TRUSTED SOURCE FOR PROJECTOR LAMPS AND ACCESSORIES**

## Connecting a Component Video source device

Examine your Video source device to determine if it has a set of unused Component Video output sockets available:

- If so, you can continue with this procedure.
- If not, you will need to reassess which method you can use to connect to the device.

### To connect the projector to a Component Video source device:

1. Take a Component Video to VGA (D-Sub) adaptor cable and connect the end with 3 RCA type connectors to the Component Video output sockets of the Video source device. Match the color of the plugs to the color of the sockets; green to green, blue to blue, and red to red.
2. Connect the other end of the Component Video to VGA (D-Sub) adaptor cable (with a D-Sub type connector) to the **D-SUB IN** socket on the projector.

The final connection path should be like that shown in the following diagram:

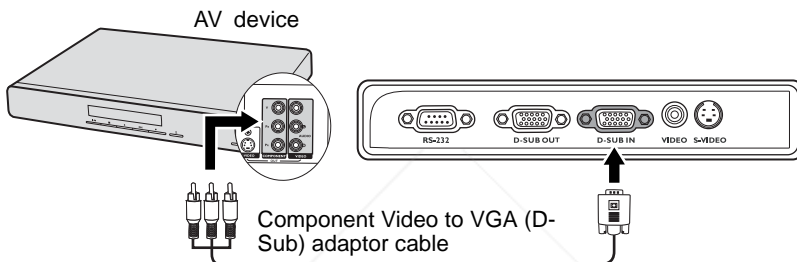

 If the selected video image is not displayed after the projector is turned on and the correct video source has been selected, check that the Video source device is turned on and operating correctly. Also check that the signal cables have been connected correctly.

## Connecting an S-Video source device

Examine your Video source device to determine if it has an unused S-Video output socket available:

- If so, you can continue with this procedure.
- If not, you will need to reassess which method you can use to connect to the device.

### To connect the projector to an S-Video source device:

1. Take an S-Video cable and connect one end to the S-Video output socket of the Video source device.
  2. Connect the other end of the S-Video cable to the **S-VIDEO** socket on the projector.
- The final connection path should be like that shown in the following diagram:

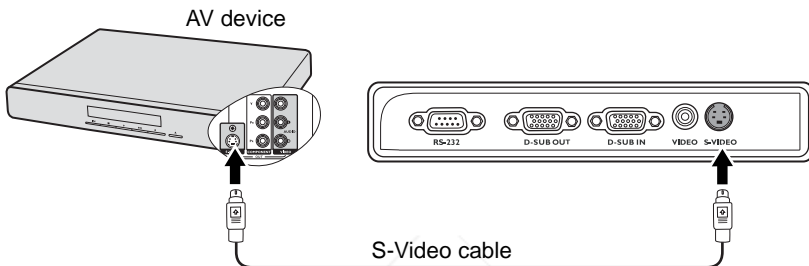

- ☞ If the selected video image is not displayed after the projector is turned on and the correct video source has been selected, check that the Video source device is turned on and operating correctly. Also check that the signal cables have been connected correctly.
- If you have already made a Component Video connection between the projector and this S-Video source device using Component Video connections, you need not connect to this device using an S-Video connection as this makes an unnecessary second connection of poorer picture quality. See "[Connecting Video source devices](#)" on page 20 for details.

## Connecting a composite Video source device

Examine your Video source device to determine if it has a set of unused composite Video output sockets available:

- If so, you can continue with this procedure.
- If not, you will need to reassess which method you can use to connect to the device.

### To connect the projector to a composite Video source device:

1. Take a Video cable and connect one end to the composite Video output socket of the Video source device.
2. Connect the other end of the Video cable to the **VIDEO** socket on the projector.

The final connection path should be like that shown in the following diagram:

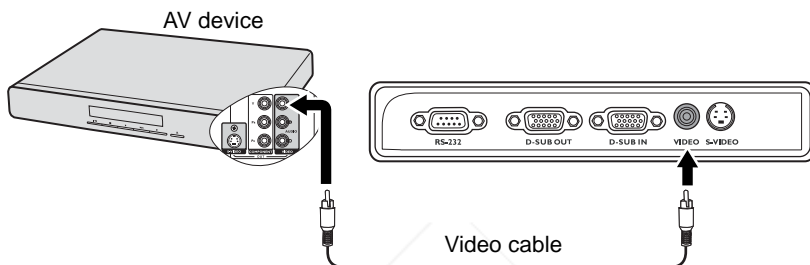

- ☞ If the selected video image is not displayed after the projector is turned on and the correct video source has been selected, check that the Video source device is turned on and operating correctly. Also check that the signal cables have been connected correctly.
- You need only connect to this device using a composite Video connection if Component Video and S-Video inputs are unavailable for use. See "[Connecting Video source devices](#)" on page 20 for details.



# Operation

## Starting up the projector

1. Plug the power cord into the projector and into a wall socket. Turn on the wall socket switch (where fitted). Check that the **POWER indicator light** on the projector lights orange after power has been applied.

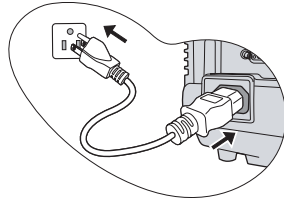

2. Remove the lens cap. If it is closed, it could become deformed due to the heat produced by the projection lamp.

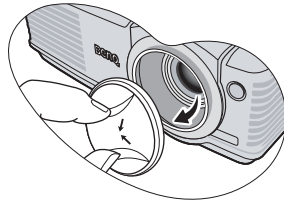

3. Press **Power** on the projector or remote control to start the projector. The **POWER indicator light** flashes green and stays green when the projector is on.  
The start up procedure takes about 30 seconds. In the later stage of start up, a startup logo is projected.  
(If necessary) Rotate the focus ring to adjust the image clearness.

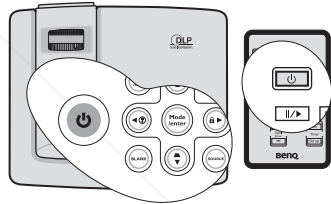

 **If the projector is still hot from previous activity, it will run the cooling fan for approximately 90 seconds before energizing the lamp.**

4. If you are prompted for a password, press the arrow keys to enter a six digit password. See "[Utilizing the password function](#)" on page 26 for details.
5. Switch all of the connected equipment on.
6. The projector will start to search for input signals. The current input signal being scanned displays in the upper left corner of the screen. If the projector doesn't detect a valid signal, the message **No Signal** will continue displaying until an input signal is found.

You can also press **SOURCE** on the projector or remote control to select your desired input signal. See "[Switching input signal](#)" on page 28 for details.

 **If the frequency/resolution of the input signal exceeds the projector's operating range, you will see the message 'Out of Range' displayed on a blank screen. Please change to an input signal which is compatible with the projector's resolution or set the input signal to a lower setting. See "[Timing chart](#)" on page 56 for details.**

# Using the menus

The projector is equipped with On-Screen Display (OSD) menus for making various adjustments and settings.

Below is the overview of the OSD menu.



To use the OSD menus, please set them to your familiar language first.

1. Press **Menu/Exit** on the projector or remote control to turn the OSD menu on.



3. Press **▼** to highlight **Language** and press **◀/▶** to select a preferred language.



2. Use **◀/▶** to highlight the **SYSTEM SETUP: Basic** menu.



4. Press **Menu/Exit** twice\* on the projector or remote control to leave and save the settings.

\*The first press leads you back to the main menu and the second press closes the OSD menu.

# Utilizing the password function

For security purposes and to help prevent unauthorized use, the projector includes an option for setting up password security. The password can be set through the On-Screen Display (OSD) menu. For details of the OSD menu operation, please refer to "Using the menus" on page 25.

 You will be inconvenienced if you activate the power-on lock functionality and subsequently forget the password. Print out this manual (if necessary) and write the password you used in this manual, and keep the manual in a safe place for later recall.

## Setting a password

 Once a password has been set, the projector cannot be used unless the correct password is entered every time the projector is started.

1. Open the OSD menu and go to the **SYSTEM SETUP: Advanced > Security Settings** menu. Press **Mode/Enter**. The **Security Settings** page displays.
2. Highlight **Power on lock** and select **On** by pressing **◀/▶**.
3. As pictured to the right, the four arrow keys (**▲**, **▶**, **▼**, **◀**) respectively represent 4 digits (1, 2, 3, 4). According to the password you desire to set, press the arrow keys to enter six digits for the password.
4. Confirm the new password by re-entering the new password.  
Once the password is set, the OSD menu returns to the **Security Settings** page.



 The digits being input will display as asterisks on-screen. Write your selected password down here in this manual in advance or right after the password is entered so that it is available to you should you ever forget it.

Password: \_ \_ \_ \_ \_

Keep this manual in a safe place.

5. To leave the OSD menu, press **Menu/Exit**.

## If you forget the password

If the password function is activated, you will be asked to enter the six-digit password every time you turn on the projector. If you enter the wrong password, the password error message as pictured to the right displays lasting for three seconds, and the message 'INPUT PASSWORD' follows. You can retry by entering another six-digit password, or if you did not record the password in this manual, and you absolutely do not remember it, you can use the password recall procedure. See "Entering the password recall procedure" on page 27 for details.

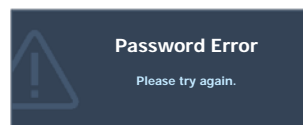

If you enter an incorrect password 5 times in succession, the projector will automatically shut down in a short time.

## Entering the password recall procedure

1. Press and hold **AUTO** on the projector or remote control for 3 seconds. The projector will display a coded number on the screen.
2. Write down the number and turn off your projector.
3. Seek help from the local BenQ service center to decode the number. You may be required to provide proof of purchase documentation to verify that you are an authorized user of the projector.

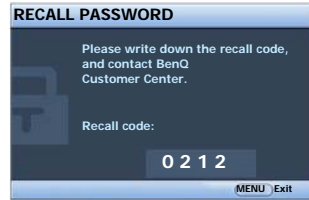

## Changing the password

1. Open the OSD menu and go to the **SYSTEM SETUP: Advanced > Security Settings > Change password** menu.
2. Press **Mode/Enter**. The message 'INPUT CURRENT PASSWORD' displays.
3. Enter the old password.
  - If the password is correct, another message 'INPUT NEW PASSWORD' displays.
  - If the password is incorrect, the password error message displays lasting for three seconds, and the message 'INPUT CURRENT PASSWORD' displays for your retry. You can press **Menu/Exit** to cancel the change or try another password.
4. Enter a new password.

 **The digits being input will display as asterisks on-screen. Write your selected password down here in this manual in advance or right after the password is entered so that it is available to you should you ever forget it.**

**Password:** \_\_\_\_\_

**Keep this manual in a safe place.**

5. Confirm the new password by re-entering the new password.
6. You have successfully assigned a new password to the projector. Remember to enter the new password next time the projector is started.
7. To leave the OSD menu, press **Menu/Exit**.



## Disabling the password function

To disable password protection, go back to the **SYSTEM SETUP: Advanced > Security Settings > Power on lock** menu after opening the OSD menu system. Select **Off** by pressing the message 'INPUT PASSWORD' displays. Enter the current password.

- If the password is correct, the OSD menu returns to the **Security Settings** page with 'Off' shown in the row of **Power on lock**. You will not have to enter the password next time you turn on the projector.
- If the password is incorrect, the password error message displays lasting for three seconds, and the message 'INPUT PASSWORD' displays for your retry. You can press **Menu/Exit** to cancel the change or try another password.

 **Though the password function is disabled, you need to keep the old password in hand should you ever need to re-activate the password function by entering the old password.**

# Switching input signal

The projector can be connected to multiple devices at the same time. However, it can only display one full screen at a time.

Be sure the **Quick Auto Search** function in the **SOURCE** menu is **On** (which is the default of this projector) if you want the projector to automatically search for the signals.

You can also manually cycle through the available input signals.

1. Press **SOURCE** on the projector or remote control. A source selection bar displays.
2. Press **▲ / ▼** until your desired signal is selected and press **Mode/Enter**.  
Once detected, the selected source information will display on the screen for seconds. If there is multiple equipment connected to the projector, repeat steps 1-2 to search for another signal.

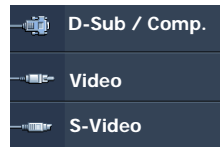
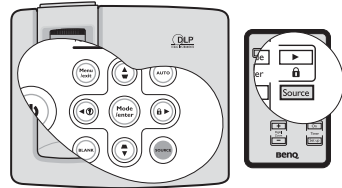

- The brightness level of the projected image will change accordingly when you switch between different input signals. Data (graphic) "PC" presentations using mostly static images are generally brighter than "Video" using mostly moving images (movies).
- The input signal type effects the options available for the Picture Mode. See "[Selecting a picture mode](#)" on page 32 for details.
- The native display resolution of this projector is in a 4:3 aspect ratio. For best display picture results, you should select and use an input signal which outputs at this resolution. Any other resolutions will be scaled by the projector depending upon the 'aspect ratio' setting, which may cause some image distortion or loss of picture clarity. See "[Selecting the aspect ratio](#)" on page 31 for details.

# Adjusting the projected image

## Adjusting the projection angle

The projector is equipped with 1 quick-release adjuster foot and 1 rear adjuster foot. These adjusters change the image height and projection angle. To adjust the projector:

1. Press the quick-release button and lift the front of the projector. Once the image is positioned where you want it, release the quick-release button to lock the foot in position.
2. Screw the rear adjuster foot to fine tune the horizontal angle.  
To retract the foot, hold up the projector while pressing the quick-release button, then slowly lower the projector. Screw the rear adjuster foot in a reverse direction.

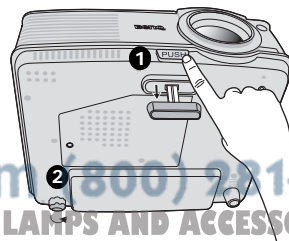

FixYourDLP.com  
Sponsored by  
DiscoveryMerchant.com (800) 921-8860  
THE TRUSTED SOURCE FOR PROJECTOR LAMPS AND ACCESSORIES

If the projector is not placed on a flat surface or the screen and the projector are not perpendicular to each other, the projected image becomes trapezoidal. To correct this situation, see "[Correcting keystone](#)" on page 30 for details.

- ⚠️ • **Do not look into the lens while the lamp is on. The strong light from the lamp may cause damage to your eyes.**
- **Be careful when you press the adjuster button as it is close to the exhaust vent where hot air comes from.**

## Auto-adjusting the image

In some cases, you may need to optimize the picture quality. To do this, press **AUTO** on the projector or remote control. Within 3 seconds, the built-in Intelligent Auto Adjustment function will re-adjust the values of Frequency and Clock to provide the best picture quality.

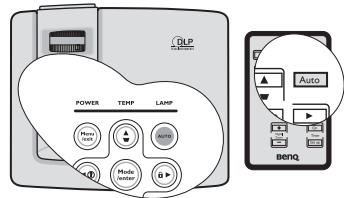

The current source information will be displayed in the upper left corner of the screen for 3 seconds.

- ☞ • **The screen will be blank while AUTO is functioning.**
- **This function is only available when PC signal (analog RGB) is selected.**

## Fine-tuning the image size and clarity

1. Adjust the projected image to the size that you need using the zoom ring. (Zoom ring is not available with the MP512.)
2. Then sharpen the image by rotating the focus ring.

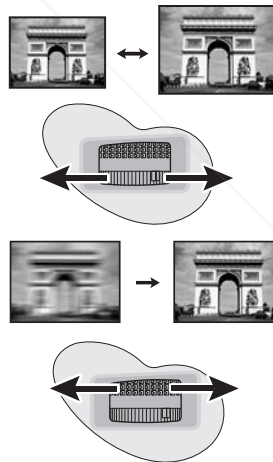

**Discount-Merchant.com (800) 281-8860**  
THE TRUSTED SOURCE FOR PROJECTOR LAMPS AND ACCESSORIES

## Correcting keystone

Keystoning refers to the situation where the projected image is noticeably wider at either the top or bottom. It occurs when the projector is not perpendicular to the screen.

To correct this, besides adjusting the height of the projector, you will need to manually correct it following one of these steps.

- Using the remote control

Press  $\nabla$  /  $\triangle$  on the projector or remote control to display the Keystone correction page. Press  $\nabla$  to correct keystoning at the top of the image. Press  $\triangle$  to correct keystoning at the bottom of the image.

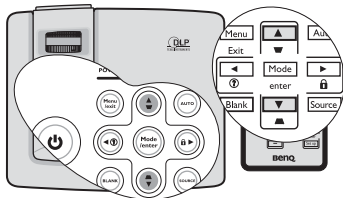

- Using the OSD menu

- Press **Menu/Exit** and then press  $\blacktriangleleft$  /  $\blacktriangleright$  until the **DISPLAY** menu is highlighted.
- Press  $\blacktriangledown$  to highlight **Keystone** and press **Mode/Enter**. The **Keystone** correction page displays.
- Press  $\nabla$  to correct keystoning at the top of the image or press  $\triangle$  to correct keystoning at the bottom of the image.



Press  $\nabla$  /  $\triangle$ .

Press  $\triangle$  /  $\nabla$ .

## Magnifying and searching for details

If you need to find the details on the projected picture, magnify the picture. Use the direction arrow keys for navigating the picture.

- Using the remote control

- Press **Digital Zoom +/-** to display the Zoom bar.
- Press **Digital Zoom +** to magnify the center of the picture. Press the key repeatedly until the picture size is suitable for your need.
- Use the directional arrows ( $\blacktriangle$ ,  $\blacktriangledown$ ,  $\blacktriangleleft$ ,  $\blacktriangleright$ ) on the projector or remote control to navigate the picture.
- To restore the picture to its original size, press **AUTO**. You can also press **Digital Zoom -**. When the key is pressed again, the picture is further reduced until it is restored to the original size.

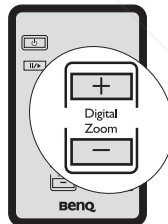

- Using the OSD menu

- Press **Menu/Exit** and then press  $\blacktriangleleft$  /  $\blacktriangleright$  until the **DISPLAY** menu is highlighted.
- Press  $\blacktriangledown$  to highlight **Digital Zoom** and press **Mode/Enter**. The Zoom bar displays.
- Repeat steps 2-4 in the section of "Using the remote control" above. Or if you are using the projector control panel, continue to the following steps.
- Press  $\blacktriangle$  on the projector repeatedly to magnify the picture to a desired size.
- To navigate the picture, press **Mode/Enter** to switch to the panning mode and press the directional arrows ( $\blacktriangle$ ,  $\blacktriangledown$ ,  $\blacktriangleleft$ ,  $\blacktriangleright$ ) to navigate the picture.

- Use the directional arrows (▲, ▼, ◀, ▶) on the projector or remote control to navigate the picture.
- To reduce size of the picture, press **Mode/Enter** to switch back to the zoom in/out functionality, and press **AUTO** to restore the picture to its original size. You can also press ▼ repeatedly until it is restored to the original size.

 **The picture can only be navigated after the picture is magnified. You can further magnify the picture while searching for details.**

## Selecting the aspect ratio

The 'aspect ratio' is the ratio of the image width to the image height. Most analog TV and computers are in 4:3 ratio, which is the default for this projector, and digital TV and DVDs are usually in 16:9 ratio.

With the advent of digital signal processing, digital display devices like this projector can dynamically stretch and scale the image output to a different aspect than that of the image input signal.

To change the projected image ratio (no matter what aspect the source is):

- Press **Menu/Exit** and then press ◀ / ▶ until the **DISPLAY** menu is highlighted.
- Press ▼ to highlight **Aspect Ratio**.
- Press ◀ / ▶ to select an aspect ratio to suit the format of the video signal and your display requirements.

### About the aspect ratio

 **In the pictures below, the black portions are inactive areas and the white portions are active areas. OSD menus can be displayed on those unused black areas.**

- Auto:** Scales an image proportionally to fit the projector's native resolution in its horizontal width. This is suitable for the incoming image which is neither in 4:3 nor 16:9 and you want to make most use of the screen without altering the image's aspect ratio.

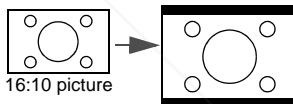

- Real:** The image is projected as its original resolution, and resized to fit within the display area. For input signals with lower resolutions, the projected image will display smaller than if resized to full screen. You could adjust the zoom setting or move the projector towards the screen to increase the image size if necessary. You may also need to refocus the projector after making these adjustments.

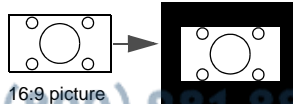
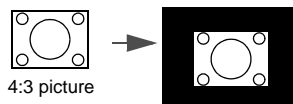
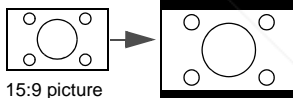

- 4:3:** Scales an image so that it is displayed in the center of the screen with a 4:3 aspect ratio. This is most suitable for 4:3 images like computer monitors, standard definition TV and 4:3 aspect DVD movies, as it displays them without aspect alteration.





4. **16:9:** Scales an image so that it is displayed in the center of the screen with a 16:9 aspect ratio. This is most suitable for images which are already in a 16:9 aspect, like high definition TV, as it displays them without aspect alteration.

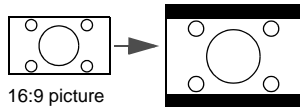

## Optimizing the image

### Selecting a picture mode

The projector is preset with several predefined picture modes so that you can choose one to suit your operating environment and input signal picture type.

To select a operation mode that suits your need, you can follow one of the following steps.

- Press **Mode/Enter** on the remote control or projector repeatedly until your desired mode is selected.
- Go to the **PICTURE > Picture Mode** menu and press **◀/▶** to select a desired mode.

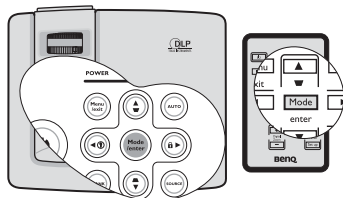

### Picture modes for different types of signals

The picture modes available for different types of signals are listed below.

#### PC input signals: D-Sub / Comp. (analog RGB)

1. **Dynamic mode (Default):** Maximizes the brightness of the projected image. This mode is suitable for environments where extra-high brightness is required, such as using the projector in well lit rooms.
2. **Presentation mode:** Is designed for presentations. The brightness is emphasized in this mode to match PC and notebook coloring.
3. **sRGB mode:** Maximizes the purity of RGB colors to provide true-to-life images regardless of brightness setting. It is most suitable for viewing photos taken with an sRGB compatible and properly calibrated camera, and for viewing PC graphic and drawing applications such as AutoCAD.
4. **Cinema mode:** Is appropriate for playing colorful movies, video clips from digital cameras or DVs through the PC input for best viewing in a blackened (little light) environment.
5. **User 1/User 2 mode:** Recalls the settings customized based on the current available picture modes. See "[Setting the User 1/User 2 mode](#)" on page 33 for details.

#### Video input signals: S-Video, Video, D-Sub / Comp. (YPbPr)

1. **Dynamic mode:** Is suitable for playing gamebox-based video games in a normal living room lighting level environment.
2. **Standard mode (Default):** Is appropriate for viewing colorful movies, video clips from digital cameras or DVs.
3. **Cinema mode:** Is suitable for enjoying dark movies or DVD movies best viewed in a blackened (little light) home cinema or lounge room environment.
4. **User 1/User 2 mode:** Recalls the settings customized based on the current available picture modes. See "[Setting the User 1/User 2 mode](#)" on page 33 for details.

## Setting the User 1/User 2 mode

There are two user-definable modes if the current available picture modes are not suitable for your need. You can use one of the picture modes (except the **User 1/User 2**) as a starting point and customize the settings.

1. Press **Menu/Exit** to open the On-Screen Display (OSD) menu.
2. Go to the **PICTURE > Picture Mode** menu.
3. Press **◀/▶** to select **User 1** to **User 2**.
4. Press **▼** to highlight **Reference Mode**.

 **This function is only available when User 1, or User 2 mode is selected up in the Picture Mode sub-menu item.**

5. Press **◀/▶** to select a picture mode that is closest to your need.
6. Press **▼** to select a sub-menu item to be changed and adjust the value with **◀/▶**. See "[Fine-tuning the image quality in user modes](#)" below for details.
7. When all settings have been done, highlight **Save Settings** and press **Mode/Enter** to store the settings.
8. The confirmation message '**Setting Saved**' displays.

## Using Wall Color

In the situation where you are projecting onto a colored surface such as a painted wall which may not be white, the **Wall Color** feature can help correct the projected picture's color to prevent possible color difference between the source and projected pictures.

To use this function, go to the **DISPLAY > Wall Color** menu and press **◀/▶** to select a color which is the closest to the color of the projection surface. There are several precalibrated colors to choose from: **Light Yellow, Pink, Light Green, Blue, and Blackboard**.

## Fine-tuning the image quality in user modes

According to the detected signal type, there are some user-definable functions available when **User 1** or **User 2** mode is selected. You can make adjustments to these functions based on your needs.

### Adjusting Brightness

Highlight **Brightness** in the **PICTURE** menu and adjust the values by pressing **◀/▶** on the projector or remote control.

The higher the value, the brighter the image. And lower the setting, darker the image. Adjust this control so the black areas of the image appear just as black and that detail in the dark areas is visible.



### Adjusting Contrast

Highlight **Contrast** in the **PICTURE** menu and adjust the values by pressing **◀/▶** on the projector or remote control.

The higher the value, the greater the contrast. Use this to set the peak white level after you have previously adjusted the **Brightness** setting to suit your selected input and viewing environment.



## Adjusting Color

Highlight **Color** in the **PICTURE** menu and adjust the values by pressing ◀/▶ on the projector or remote control.

Lower setting produces less saturated colors. If the setting is too high, colors on the image will be overpowering, which makes the image unrealistic.

## Adjusting Tint

Highlight **Tint** in the **PICTURE** menu and adjust the values by pressing ◀/▶ on the projector or remote control.

The higher the value, the more reddish the picture becomes. The lower the value, the more greenish the picture becomes.

## Adjusting Sharpness

Highlight **Sharpness** in the **PICTURE** menu and adjust the values by pressing ◀/▶ on the projector or remote control.

The higher the value, the sharper the picture becomes. The lower the value, the softer the picture becomes.

## Adjusting Brilliant Color

Highlight **Brilliant Color** in the **PICTURE** menu and select by pressing ◀/▶ on the projector or remote control.

This feature utilizes a new color-processing algorithm and system level enhancements to enable higher brightness while providing truer, more vibrant colors in picture. It enables a greater than 50% brightness increase in mid-tone images, which are common in video and natural scenes, so the projector reproduces images in realistic and true colors. If you prefer images with that quality, select **On**. If you don't need it, select **Off**.

**On** is the default and recommended selection for this projector. When **Off** is selected, the **Color Temperature** function is not available.

## Selecting a Color Temperature

Highlight **Color Temperature** in the **PICTURE** menu and adjust the values by pressing ◀/▶ on the projector or remote control.

The options available for color temperature\* settings vary according to the signal type selected.

1. **T1:** With the highest color temperature, T1 makes the image appear the most bluish white than other settings.
2. **T2:** Makes images appear bluish white.
3. **T3:** Maintains normal colorings for white.
4. **T4:** Makes images appear reddish white.

### \*About color temperatures:

There are many different shades that are considered to be "white" for various purposes. One of the common methods of representing white color is known as the "color temperature". A white color with a low color temperature appears to be reddish white. A white color with a high color temperature appears to have more blue in it.

## 3D Color Management

In most installation situations, color management will not be necessary, such as in classroom, meeting room, or lounge room situations where lights remain on, or where building external windows allow daylight into the room.

Only in permanent installations with controlled lighting levels such as boardrooms, lecture theaters, or home theaters, should color management be considered. Color management provides fine color control adjustment to allow for more accurate color reproduction, should you require it.

Proper color management can only be achieved under controlled and reproducible viewing conditions. You will need to use a colorimeter (color light meter), and provide a set of suitable source images to measure color reproduction. These tools are not provided with the projector, however, your projector supplier should be able to provide you with suitable guidance, or even an experienced professional installer.

The Color Management provides six sets (RGBCMY) of colors to be adjusted. When you select each color, you can independently adjust its range and saturation according to your preference.

If you have purchased a test disc which contains various color test patterns and can be used to test the color presentation on monitors, TVs, projectors, etc. You can project any image from the disc on the screen and enter the **3D Color Management** menu to make adjustments.

To adjust the settings:

1. Go to the **PICTURE** menu and highlight **3D Color Management**.
2. Press **Mode/Enter** and the **3D Color Management** page displays.
3. Highlight **Primary Color** and press **◀/▶** to select a color from among Red, Yellow, Green, Cyan, Blue, or Magenta.
4. Press **▼** to highlight **Hue** and press **◀/▶** to select its range. Increase in the range will include colors consisted of more proportions of its two adjacent colors.

Please refer to the illustration to the right for how the colors relate to each other.

For example, if you select Red and set its range at 0, only pure red in the projected picture will be selected. Increasing its range will include red close to yellow and red close to magenta.

5. Press **▼** to highlight **Saturation** and adjust its values to your preference by pressing **◀/▶**. Every adjustment made will reflect to the image immediately.

For example, if you select Red and set its value at 0, only the saturation of pure red will be affected.

6. Press **▼** to highlight **Gain** and adjust its values to your preference by pressing **◀/▶**. The contrast level of the primary color you select will be affected. Every adjustment made will reflect to the image immediately.

Repeat steps 3 to 6 for other color adjustments.

7. Repeat steps 3 to 6 for other color adjustments.
8. Make sure you have made all of the desired adjustments.
9. Press **Menu/Exit** to exit and save the settings.

 Saturation is the amount of that color in a video picture. Lower settings produce less saturated colors; a setting of "0" removes that color from the image entirely. If the saturation is too high, that color will be overpowering and unrealistic.

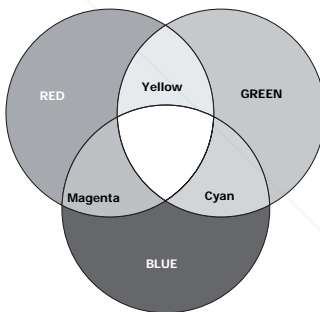

# Setting the presentation timer

The presentation timer can indicate the presentation time on the screen to help you achieve better time management when giving presentations. Follow these steps to utilize this function:

1. Press **Timer Setup** on the remote control or go to the **SYSTEM SETUP: Basic > Presentation Timer** menu and press **Mode/Enter** to display the **Presentation Timer** page.
2. Press **▼** to highlight **Timer period** and decide the timer period by pressing **◀/▶**. The length of time can be set from 1 to 5 minutes in 1-minute increments and 5 to 240 minutes in 5-minute increments.

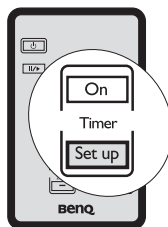

**☞ If the timer is already on, the timer will restart whenever the Timer period is reset.**

3. Press **▼** to highlight **Timer display** and choose if you want the timer to show up on the screen by pressing **◀/▶**.

Selection	Description
Always	Displays the timer on screen throughout the presentation time.
1 min/2 min/3 min	Displays the timer on screen in the last 1/2/3 minute(s).
Never	Hides the timer throughout the presentation time.

4. Press **▼** to highlight **Timer position** and set the timer position by pressing **◀/▶**.

**Top-Left → Bottom-Left → Top-Right → Bottom-Right**

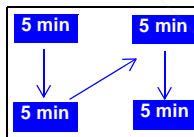

5. Press **▼** to highlight **Timer counting direction** and select your desired counting direction by pressing **◀/▶**.

Selection	Description
<b>Count Up</b>	Increases from 0 to the preset time.
<b>Count Down</b>	Decrease from the preset time to 0.

6. To activate the presentation timer, press **▼** and press **◀/▶** to select **On** and press **Mode/Enter**.

7. A confirmation message displays. Highlight **Yes** and press **Mode/Enter** to confirm. You will see the message **"Timer is On"** displaying on the screen. The timer starts counting at the time the timer is on.

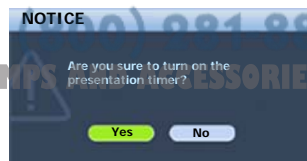

## To cancel the timer, perform the following steps.

1. Go back to the **Presentation Timer** page.
2. Press **▼** and press **◀/▶** to highlight **Off** and press **Mode/Enter**. A confirmation message displays.
3. Highlight **Yes** and press **Mode/Enter** to confirm. You will see the message “**Timer is Off**” displaying on the screen.

## How to use the TIMER On key?

**Timer On** is a multi-functional key.

- If the presentation timer is off, pressing this key displays a confirmation message. You can decide whether to activate the timer or not by following the on-screen instruction.
- If the timer is already on, pressing this key displays a confirmation message. You can decide whether to restart, continue or turn off the timer by following the on-screen instruction.

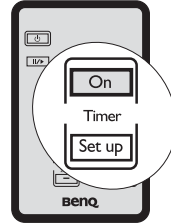

## Hiding the image

In order to draw the audience's full attention to the presenter, you can use **BLANK** on the projector or remote control to hide the screen image. Press any key on the projector or remote control to restore the image. The word '**BLANK**' appears at the lower right corner of the screen while the image is hidden.

You can set the blank time in the **SYSTEM SETUP: Basic > Blank Timer** menu to let the projector return the image automatically after a period of time when there is no action taken on the blank screen.

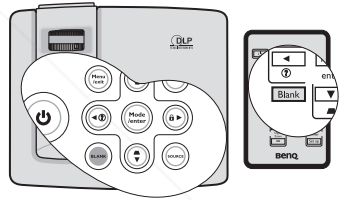

 Once **BLANK** is pressed, the projector enters **Economic mode** automatically.

 Do not block the projection lens from projecting as this could cause the blocking object to become heated and deformed or even cause a fire.

## Locking control keys

With the control keys on the projector locked, you can prevent your projector settings from being changed accidentally (by children, for example). When the **Panel Key Lock** is on, no control keys on the projector will operate except **Power**.

1. Press **▶/🔒** on the projector or remote control or go to the **SYSTEM SETUP: Basic > Panel Key Lock** menu, and select **On** by pressing **◀/▶** on the projector or remote control.
2. A confirmation message displays. Select **Yes** to confirm.

To release panel key lock, press and hold **▶/🔒** for 3 seconds on the projector or remote control.

You can also use the remote control to enter the **SYSTEM SETUP: Basic > Panel Key Lock** and press **◀/▶** to select **Off**.

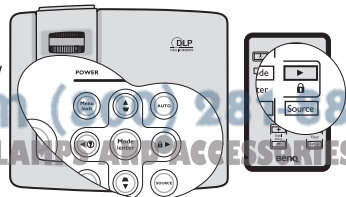



- Keys on the remote control are still in use when panel key lock is enabled.
- If you press Power to turn off the projector without disabling panel key lock, the projector will still be in locked status the next time it is turned on.

## Freezing the image

Press **||/▶** on the remote control to freeze the image. The word **'FREEZE'** will display in the upper left corner of the screen. To release the function, press any key on the projector or remote control.

Even if an image is frozen on the screen, the pictures are running on the video or other device. If the connected devices have active audio output, you will still hear the audio even though the image is frozen on screen.

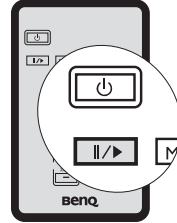

## Utilizing FAQ function

The **INFORMATION** menu contains possible solutions to problems encountered by users regarding image quality, installation, special feature operation and service information.

To get the FAQ information:

1. Press **◀/?** on the projector or remote control or press **Menu/Exit** to open the OSD menu and press **◀/▶** to highlight the **INFORMATION** menu.
2. Press **▼** to highlight **FAQ-Image and Installation** or **FAQ-Features and Service** based on the information you want to know.
3. Press **Mode/Enter**.
4. Press **▲/▼** to select a problem and press **Mode/Enter** for possible solutions.
5. Press **Menu/Exit** to exit the OSD.

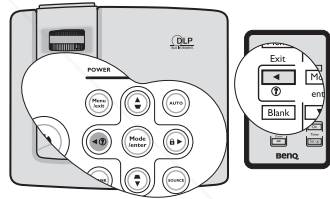

To exit the OSD menu, press **Menu/Exit**.

## Operating in a high altitude environment

We recommend you use the **High Altitude Mode** when your environment is between 1500 m –3000 m above sea level, and temperature is between 0°C–35°C.



**Do not use the High Altitude Mode if your altitude is between 0 m and 1500 m and temperature is between 0°C and 35°C. The projector will be over cooled, if you turn the mode on under such condition.**

To activate the **High Altitude Mode**:

1. Press **Menu/Exit** and then press **◀/▶** until the **SYSTEM SETUP: Advanced** menu is highlighted.
2. Press **▼** to highlight **High Altitude Mode** and press **◀/▶** to select **On**. A confirmation message displays.
3. Highlight **Yes** and press **Mode/Enter**.

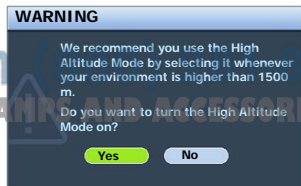

FixYourDL.com  
Sponsored by (DM)

DiscountProjector.com 860  
THE TRUSTED SOURCE FOR PROJECTOR LAMP PARTS

Operation under "**High Altitude Mode**" may cause a higher decibel operating noise level because of increased fan speed necessary to improve overall system cooling and performance.

If you use this projector under other extreme conditions excluding the above, it may display auto shut-down symptoms, which is designed to protect your projector from over-heating. In cases like this, you should switch to High Altitude mode to solve these symptoms. However, this is not to state that this projector can operate under any and all harsh or extreme conditions.

## Personalizing the projector menu display

The On-Screen Display (OSD) menus can be set according to your preferences. The following settings do not affect the projection settings, operation, or performance.

- **Menu display time** in the **SYSTEM SETUP: Advanced > Menu Settings** menu sets the length of time the OSD will remain active after your last key press. The time length ranges from 5 to 30 seconds in 5-second increments. Use ◀/▶ to select a suitable time frame.
- **Menu position** in the **SYSTEM SETUP: Advanced > Menu Settings** menu sets the OSD position in five locations. Use ◀/▶ to select a preferred position.
- **Language** in the **SYSTEM SETUP: Basic** menu sets your familiar language for the OSD menus. Use ◀/▶ to select your language.
- **Splash Screen** in the **SYSTEM SETUP: Basic** menu sets a preferred logo screen to be displayed during projector start-up. Use ◀/▶ to select a screen.

## Shutting down the projector

1. Press **Power** and a confirmation message displays prompting you.  
If you don't respond in a few seconds, the message will disappear.
2. Press **Power** a second time. The **POWER indicator light** flashes orange, the projection lamp shuts down, and the fans will continue to run for approximately 90 seconds to cool down the projector.
3. Once the cooling process finishes, the **POWER indicator light** is a steady orange and fans stop.
4. Disconnect the power cord from the wall socket if the projector will not be used in an extended period of time.

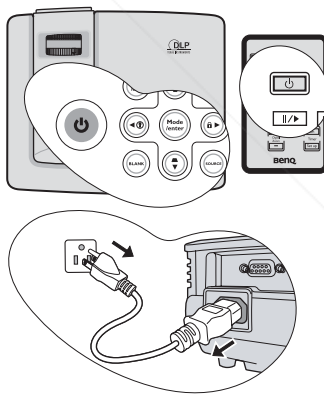

To protect the lamp, the projector will not respond to any commands during the cooling process.

- To shorten the cooling time, you can also activate the Quick Cooling function. See "**Quick Cooling**" on page 44 for details.
- Do not unplug the power cord before the projector shutdown sequence is complete or during the 90-second cooling down process.
- If the projector is not properly shut down, to protect the lamp, when you attempt to re-start the projector, the fans will run for a few minutes to cool down. Press Power again to start the projector after the fans stop and the POWER indicator light turns orange.



# Menu operation

## Menu system

Please note that the on-screen display (OSD) menus vary according to the signal type selected.

Main menu	Sub-menu	Options	
<b>1. DISPLAY</b>	Wall Color	Off/Light Yellow/Pink/Light Green/Blue/Blackboard	
	Aspect Ratio	Auto/Real/4:3/16:9	
	Keystone		
	Position		
	Phase		
	H. Size		
	Digital Zoom		
<b>2. PICTURE</b>	Picture Mode	PC source: Dynamic/Presentation/sRGB/Cinema/ User 1/User 2 Video source: Dynamic/Standard/Cinema/User 1/ User 2	
	Reference Mode	PC source: Dynamic/Presentation/sRGB/Cinema Video source: Dynamic/Standard/Cinema	
	Brightness		
	Contrast		
	Color		
	Tint		
	Sharpness		
	Brilliant Color	On/Off	
	Color Temperature	T1/T2/T3/T4	
	3D Color Management	Primary Color	R/G/B/Y/C/M
		Hue	
		Saturation	
	Gain		
	Save Settings		
<b>3. SOURCE</b>	Quick Auto Search	On/Off	
	Current System Status	<ul style="list-style-type: none"> <li>• Source</li> <li>• Picture Mode</li> <li>• Resolution</li> <li>• Color System</li> <li>• Equivalent Lamp Hour</li> </ul>	



Discount-Medical.com (800) 281-8860

THE TRUSTED SOURCE FOR PROJECTOR LAMPS AND ACCESSORIES

## 6. INFORMATION

<b>4. SYSTEM SETUP: Basic</b>	<b>Presentation Timer</b>	<b>Timer period</b>	1~240 minutes
		<b>Timer display</b>	Always/1 min/2 min/3 min/Never
		<b>Timer position</b>	<b>Top-Left/Bottom-Left/Top-Right/Bottom-Right</b>
		<b>Timer counting direction</b>	<b>Count Down/Count Up</b>
		<b>On/Off</b>	
	<b>Language</b>		ENGLISH/ FRANÇAIS/ DEUTSCH/ ITALIANO/ ESPAÑOL/ РУССКИЙ/ 繁體中文/ 简体中文/ 日本語/ 한국어/ Svenska/ Nederlands/ Türkçe/ Čeština/ Português/ తెలుగు/ Polski
	<b>Projector Position</b>		<b>Front Table/Rear Table/Rear Ceiling/Front Ceiling</b>
	<b>Auto Power Off</b>		<b>Disable</b> /5 min/10 min/15 min/20 min/25 min/30 min
	<b>Blank Timer</b>		<b>Disable</b> /5 min/10 min/15 min/20 min/25 min/30 min
	<b>Panel Key Lock</b>		<b>On/Off</b>
<b>Sleep Timer</b>		<b>Disable</b> /30 min/1 hr/2 hr/3 hr/4 hr/8 hr/12 hr	
<b>Splash Screen</b>		Black/Blue/BenQ	
<b>Quick Cooling</b>		<b>On/Off</b>	
<b>High Altitude Mode</b>		<b>On/Off</b>	
<b>Menu Settings</b>	<b>Menu display time</b>	5 sec/10 sec/15 sec/20 sec/25 sec/30 sec	
	<b>Menu position</b>	Center/Top-left/Top-right/Bottom-right/Bottom-left	
<b>Standby D-Sub Output</b>		<b>On/Off</b>	
<b>Lamp Settings</b>	<b>Lamp mode</b>	<b>Normal/Economic</b>	
	<b>Reset lamp timer</b>		
	<b>Equivalent lamp hour</b>		
<b>Security Settings</b>	<b>Change password</b>		
	<b>Power on lock</b>	<b>On/Off</b>	
<b>Baud Rate</b>		2400/4800/9600/14400/19200/38400/57600/115200	
<b>Test Pattern</b>		<b>On/Off</b>	
<b>Closed Caption</b>	<b>Closed Caption</b>	<b>On/Off</b>	
	<b>Enable</b>		
	<b>Caption Version</b>	CC1/CC2/CC3/CC4	
<b>Reset All Settings</b>			

#### **5. SYSTEM SETUP: Advanced**





**Discount-Merchants.com (800) 281-8860**  
**THE TRUSTED SOURCE FOR PROJECTOR LAMPS AND ACCESSORIES**

Note that the menu items are available when the projector detects at least one valid signal. If there is no equipment connected to the projector or no signal detected, limited menu items are accessible.

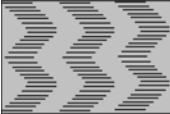
# Description of each menu



	<b>FUNCTION</b> (default setting/ value)	<b>DESCRIPTION</b> (default setting/value)
<b>1. DISPLAY menu</b>	<b>Wall Color</b> (Off)	Corrects the projected picture's color when the projection surface is not white. See <a href="#">"Using Wall Color" on page 33</a> for details.
	<b>Aspect Ratio</b> (Auto)	There are four options to set the image's aspect ratio depending on your input signal source. See <a href="#">"Selecting the aspect ratio" on page 31</a> for details.
	<b>Keystone</b> (0)	Corrects any keystone of the image. See <a href="#">"Correcting keystone" on page 30</a> for details.
	<b>Position</b> (0)	Displays the position adjustment page. To move the projected image, use the directional arrow keys. The values shown on the lower position of the page change with every key press you made until they reach their maximum or minimum.
	<b>Phase</b> (depends on the selected input signal)	Adjusts the clock phase to reduce image distortion. 
	<b>H. Size</b> (0)	Adjusts the horizontal width of the image.
	<b>Digital Zoom</b> (1.0X)	Magnifies or reduces the projected image. See <a href="#">"Magnifying and searching for details" on page 30</a> for details.
<b>2. PICTURE menu</b>	<b>Picture Mode</b> (PC source: <b>Dynamic</b> ; Video source: <b>Standard</b> )	Pre-defined picture modes are provided so you can optimize your projector image set-up to suit your program type. See <a href="#">"Selecting a picture mode" on page 32</a> for details.
	<b>Reference Mode</b> (Dynamic)	Selects a picture mode that most suits your need for the image quality and further fine-tune the image based on the selections listed on the same page below. See <a href="#">"Setting the User 1/User 2 mode" on page 33</a> for details.
	<b>Brightness</b> (50)	Adjusts the brightness of the image. See <a href="#">"Adjusting Brightness" on page 33</a> for details.
	<b>Contrast</b> (0)	Adjusts the degree of difference between dark and light in the image. See <a href="#">"Adjusting Contrast" on page 33</a> for details.
	<b>Color</b> (0)	Adjusts the color saturation level – the amount of each color in a video image. See <a href="#">"Adjusting Color" on page 34</a> for details.

FUNCTION (default setting/ value)		DESCRIPTION (default setting/value)
2. PICTURE menu	<b>Tint</b> (0)	Adjusts the red and green color tones of the image. See " <a href="#">Adjusting Tint</a> " on page 34 for details.  <b>The function is only available when Video or S-Video with NTSC system is selected.</b>
	<b>Sharpness</b> (15)	Adjusts the image to make it look sharper or softer. See " <a href="#">Adjusting Sharpness</a> " on page 34 for details.
	<b>Brilliant Color</b> (On)	Adjusts white peaking while maintaining correct color presentation. See " <a href="#">Adjusting Brilliant Color</a> " on page 34 for details.
	<b>Color Temperature</b> (T1)	See " <a href="#">Selecting a Color Temperature</a> " on page 34 for details.
	<b>3D Color Management</b>	See " <a href="#">3D Color Management</a> " on page 34 for details.
	<b>Save Settings</b>	Saves the settings made for <b>User 1</b> or <b>User 2</b> mode.
	3. SOURCE menu	<b>Quick Auto Search</b> (On)
4. SYSTEM SETUP Basic menu	<b>Presentation Timer</b> (Off)	Reminds the presenter to finish the presentation within a certain time frame. See " <a href="#">Setting the presentation timer</a> " on page 36 for details. <b>Timer period (15 min.)</b> Sets a preferred length of time for presentation. <b>Timer display (Always)</b> Sets whether to display the timer on screen. <b>Timer position (Top-Left)</b> Sets the position where the timer displays on screen. <b>Timer counting direction (Count Down)</b> Sets the timer counting direction.
	<b>Language</b> (English)	Sets the language for the On-Screen Display (OSD) menus. See " <a href="#">Using the menus</a> " on page 25 for details.

	<b>FUNCTION</b> (default setting/ value)	<b>DESCRIPTION</b> (default setting/value)
<b>4. SYSTEM SETUP: Basic menu</b>	<b>Projector Position</b> (Front Table)	The projector can be installed on a ceiling or behind a screen, or with one or more mirrors. See " <a href="#">Choosing a location</a> " on page 13 for details.
	<b>Auto Power Off</b> (Disable)	Allows the projector to turn off automatically if no input signal is detected after a set period of time. See " <a href="#">Setting Auto Power Off</a> " on page 48 for details.
	<b>Blank Timer</b> (Disable)	Sets the image blank time when the Blank feature is activated, once elapsed the image will return to the screen. See " <a href="#">Hiding the image</a> " on page 37 for details.
	<b>Panel Key Lock</b> (Off)	Disables or enables all panel key functions except <b>Power</b> on the projector and keys on the remote control. See " <a href="#">Locking control keys</a> " on page 37 for details.
	<b>Sleep Timer</b> (Disable)	Sets the auto-shutdown timer. The timer can be set to a value between 30 minutes and 12 hours.
	<b>Splash Screen</b> (BenQ logo)	Allows you to select which logo screen will display during projector start-up. Three options are available: BenQ logo, Black screen, or Blue screen.
<b>5. SYSTEM SETUP: Advanced menu</b>	<b>Quick Cooling</b> (On)	Selecting <b>On</b> enables the function and the projector cooling time will be shortened to a few seconds.   <b>If you attempt to restart the projector right after the quick cooling process, it may not be turned on successfully and will rerun its cooling fans.</b>
	<b>High Altitude Mode</b> (Off)	A mode for operation in high altitude areas. See " <a href="#">Operating in a high altitude environment</a> " on page 38 for details.
	<b>Menu Settings</b>	<b>Menu display time (15 sec)</b> Sets the length of time the OSD will remain active after your last key press. The range is from 5 to 30 seconds in 5-second increments.  <b>Menu position (Center)</b> Sets the On-Screen Display (OSD) menu position.



**Discount-Merchant.com (800) 281-8860**  
**THE TRUSTED SOURCE FOR PROJECTOR LAMPS AND ACCESSORIES**

FUNCTION (default setting/ value)	DESCRIPTION (default setting/value)
<b>Standby D-Sub Output</b> (Off)	Selecting <b>On</b> enables the function. The projector can output a VGA signal when it is in standby mode and the <b>D-SUB IN</b> and <b>D-SUB OUT</b> sockets are correctly connected to devices. See " <a href="#">Connecting a monitor</a> " on page 19 for how to make the connection.   <b>Enabling this function slightly increases the standby power consumption.</b>
<b>Lamp Settings</b>	<b>Lamp mode (Normal)</b> See " <a href="#">Setting Lamp mode as Economic</a> " on page 48 for details.  <b>Reset lamp timer</b> See " <a href="#">Resetting the lamp timer</a> " on page 52 for details.  <b>Equivalent lamp hour</b> See " <a href="#">Getting to know the lamp hour</a> " on page 48 for details on how the total lamp hour is calculated.
<b>Security Settings</b>	<b>Change password</b> You will be asked to enter the current password before changing to a new one.  <b>Power on lock (Off)</b> See " <a href="#">Utilizing the password function</a> " on page 26 for details.
<b>Baud Rate</b> (115200)	Selects a baud rate that is identical with your computer's so that you can connect the projector using a suitable RS-232 cable and update or download the projector's firmware. This function is intended for qualified service personnel.
<b>Test Pattern</b> (Off)	Selecting <b>On</b> enables the function and the projector displays the grid test pattern. It helps you adjust the image size and focus and check that the projected image is free from distortion.
<b>Closed Caption</b>	<b>Closed Caption Enable (Off)</b> Activates the function by selecting <b>On</b> when the selected input signal carries closed captions. <ul style="list-style-type: none"> <li>• Captions: An on-screen display of the dialogue, narration, and sound effects of TV programs and videos that are closed captioned (usually marked as "CC" in TV listings).</li> </ul> <b>Caption Version (CC1)</b> Selects a preferred closed captioning mode. To view captions, select CC1, CC2, CC3, or CC4 (CC1 displays captions in the primary language in your area).
<b>Reset All Settings</b>	Returns all settings to the factory preset values.   <b>The following settings will still remain: Position, Phase, H. Size, User 1, User 2, Language, Projector Position, High Altitude Mode, Security Settings, Baud Rate.</b>

<b>FUNCTION</b> (default setting/ value)	<b>DESCRIPTION</b> (default setting/value)
<b>FAQ-Image and Installation</b>	Displays possible solutions to problems you may encounter.
<b>FAQ- Features and Service</b>	
<b>6. INFORMATION menu</b>  <b>Current System Status</b>	<b>Source</b> Shows the current signal source.
	<b>Picture Mode</b> Shows the selected mode in the <b>PICTURE</b> menu.
	<b>Resolution</b> Shows the native resolution of the input signal.
	<b>Color System</b> Shows input system format, NTSC, PAL, SECAM, or RGB.
	<b>Equivalent Lamp Hour</b> Displays the number of hours the lamp has been used.



**Discount-Merchant.com (800) 281-8860**  
**THE TRUSTED SOURCE FOR PROJECTOR LAMPS AND ACCESSORIES**

# Maintenance

## Care of the projector

Your projector needs little maintenance. The only thing you need to do on a regular basis is to keep the lens clean.

Never remove any parts of the projector except the lamp. Contact your dealer if other parts need replacing.

### Cleaning the lens

Clean the lens whenever you notice dirt or dust on the surface.

- Use a canister of compressed air to remove dust.
- If there is dirt or smears, use lens-cleaning paper or moisten a soft cloth with lens cleaner and gently wipe the lens surface.

 **Never rub the lens with abrasive materials.**

### Cleaning the projector case

Before you clean the case, turn the projector off using the proper shutdown procedure as described in "[Shutting down the projector](#)" on page 39 and unplug the power cord.

- To remove dirt or dust, wipe the case with a soft, lint-free cloth.
- To remove stubborn dirt or stains, moisten a soft cloth with water and a neutral pH detergent. Then wipe the case.

 **Never use wax, alcohol, benzene, thinner or other chemical detergents. These can damage the case.**

### Storing the projector

If you need to store the projector for an extended time, please follow the instructions below:

- Make sure the temperature and humidity of the storage area are within the recommended range for the projector. Please refer to "[Specifications](#)" on page 55 or consult your dealer about the range.
- Retract the adjuster feet.
- Remove the battery from the remote control.
- Pack the projector in its original packing or equivalent.

### Transporting the projector

It is recommended that you ship the projector with its original packing or equivalent.



**Discount-Merchant.com (800) 281-8860**  
**THE TRUSTED SOURCE FOR PROJECTOR LAMPS AND ACCESSORIES**



# Lamp information

## Getting to know the lamp hour

When the projector is in operation, the duration (in hours) of lamp usage is automatically calculated by the built-in timer. The method of calculating the equivalent lamp hour is as follows:

Total (equivalent) lamp hour  
= 1 (hours used in Economic mode) + 4/3 (hours used in normal mode)

☞ See "**Setting Lamp mode as Economic**" below for more information on **Economic mode**.

The lamp hour in **Economic** mode is calculated as 3/4 of that in **Normal** mode. That is, using the projector in **Economic** mode helps to extend the lamp hour by 1/3.

To obtain the lamp hour information:

1. Press **Menu/Exit** and then press ◀/▶ until the **SYSTEM SETUP: Advanced** menu is highlighted.
2. Press ▼ to highlight **Lamp Settings** and press **Mode/Enter**. The **Lamp Settings** page displays.
3. You will see the **Equivalent lamp hour** information displaying on the menu.
4. To leave the menu, press **Menu/Exit**.

You can also get the lamp hour information on the **INFORMATION** menu.

## Extending lamp life

The projection lamp is a consumable item that normally can last up to 3000-4000 hours with proper usage. To keep the lamp life as long as possible, you can do the following settings via the OSD menu.

### Setting Lamp mode as Economic

Using **Economic** mode reduces system noise and power consumption by 20%. If the **Economic** mode is selected, the light output will be reduced and result in darker projected pictures.

Setting the projector in **Economic** mode also extends the lamp operation life. To set **Economic** mode, go into the **SYSTEM SETUP: Advanced > Lamp Settings > Lamp mode** menu and press ◀/▶.

### Setting Auto Power Off

This function allows the projector to turn off automatically if no input source is detected after a set period of time to prevent unnecessary waste of lamp life.

To set **Auto Power Off**, go into the **SYSTEM SETUP: Basic > Auto Power Off** menu and press ◀/▶. The time period can be set from 5 to 30 minutes in 5-minute increments. If the preset time lengths are not suitable for your presentation, select **Disable**. The projector will not automatically shut down in a certain time period.



FixYourPDF.com



Discount-Merchant.com (800) 281-8860  
THE TRUSTED SOURCE FOR PROJECTOR LAMPS AND ACCESSORIES

## Timing of replacing the lamp

When the **Lamp indicator** lights up red or a message appears suggesting it is time to replace the lamp, please install a new lamp or consult your dealer. An old lamp may cause a malfunction in the projector and in some instances the lamp may explode.

 **The Lamp indicator light and Temperature warning light will light up if the lamp becomes too hot. Turn the power off and let the projector cool for 45 minutes. If the Lamp or Temp indicator still lights up after turning the power back on, please contact your dealer. See "Indicators" on page 53 for details.**

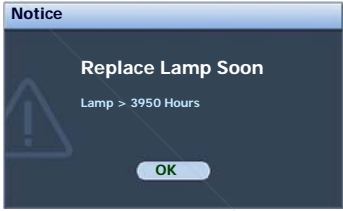
The following lamp warning displays will remind you to change the lamp.

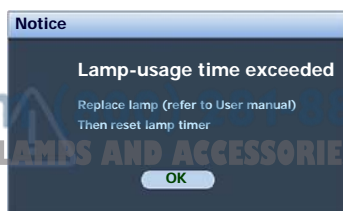
Status	Message
<p>The lamp has been in operation for 3000 hours. Install a new lamp for optimal performance. If the projector is normally run with <b>Economic</b> selected (See "<a href="#">Setting Lamp mode as Economic</a>" on page 48), you may continue to operate the projector until the 3950 hour lamp warning appears.</p>	
<p>The lamp has been in operation for 3950 hours. A new lamp should be fitted to avoid the inconvenience when the projector runs out of lamp time.</p>	
<p>The lamp has been in operation for 4000 hours. It is strongly recommended that you replace the lamp at this age. The lamp is a consumable item. The lamp brightness diminishes with use. This is normal lamp behavior. You can replace the lamp whenever you notice that the brightness level has significantly diminished. If the lamp is not replaced beforehand, it must be replaced after 4000 hours usage.</p>	
<p>The lamp <b>MUST</b> be replaced before the projector will operate normally.</p>	



FixYourDLP.com

Sponsored by DM

Discount-Merchant.com THE TRUSTED SOURCE FOR PROJECTOR LAMPS AND ACCESSORIES

# Replacing the lamp

- ⚠️ • If lamp replacement is performed while the projector is suspended upside-down from the ceiling, make sure that no one is underneath the lamp socket to avoid any possible injury or damage to the human eyes caused by fractured lamp.
- To reduce the risk of electrical shock, always turn the projector off and disconnect the power cord before changing the lamp.
- To reduce the risk of severe burns, allow the projector to cool for at least 45 minutes before replacing the lamp.
- To reduce the risk of injuries to fingers and damage to internal components, use caution when removing lamp glass that has shattered into sharp pieces.
- To reduce the risk of injuries to fingers and/or compromising image quality by touching the lens, do not touch the empty lamp compartment when the lamp is removed.
- This lamp contains mercury. Consult your local hazardous waste regulations to dispose of this lamp in a proper manner.
- To assure optimal performance from the projector, it is recommended that you purchase a BenQ projector lamp for lamp replacement.

1. Turn the power off and disconnect the projector from the wall socket. If the lamp is hot, avoid burns by waiting for approximately 45 minutes until the lamp has cooled.
2. Turn the projector over. Then loosen the screws on the lamp cover.

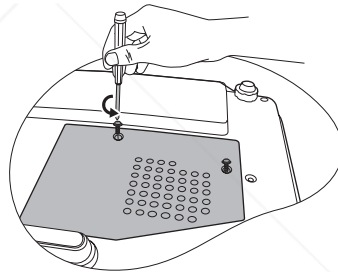

3. Remove the lamp cover from the projector.

- ⚠️ • Do not turn the power on with the lamp cover removed.
- Do not insert your fingers between the lamp and the projector. The sharp edges inside the projector may cause injuries.

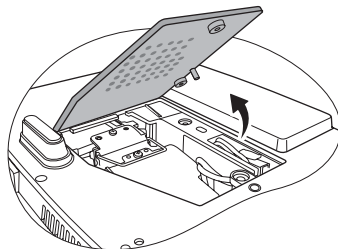

4. Loosen the screw that secures the lamp.

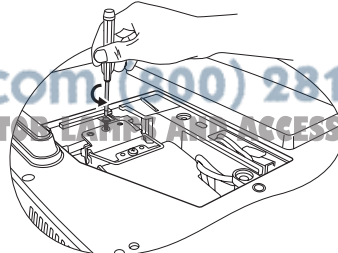

5. Pull out the lamp connector from a slot in the lamp compartment. Disconnect it from the projector as illustrated.
6. Lift the handle so that it stands up. Use the handle to slowly pull the lamp out of the projector.

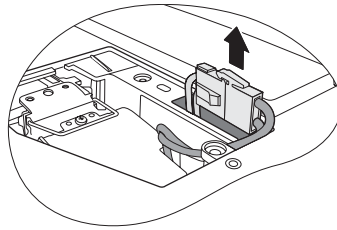

 • **Pulling it too quickly may cause the lamp to break and scatter broken glass in the projector.**

- **Do not place the lamp in locations where water might splash on it, children can reach it, or near flammable materials.**
- **Do not insert your hands into the projector after the lamp is removed. If you touch the optical components inside, it could cause color unevenness and distortion of the projected images.**

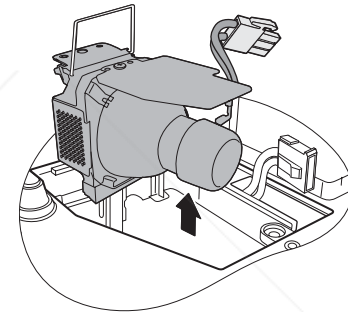
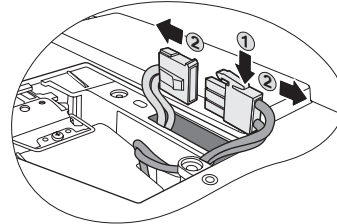

7. Insert the new lamp into the lamp compartment and make sure it fits in the projector.
8. Reconnect the lamp connector and place it back into its slot to be flush with the projector.

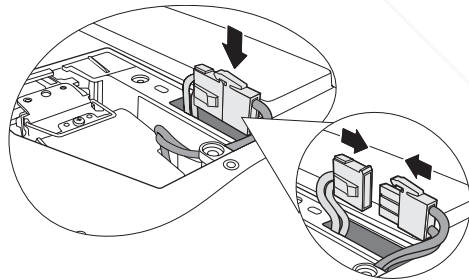

9. Tighten the screw that secures the lamp.



• **Loose screw may cause a bad connection, which could result in malfunction.**

• **Do not over tighten the screw.**

10. Ensure the handle is fully laid flat and locked in place.

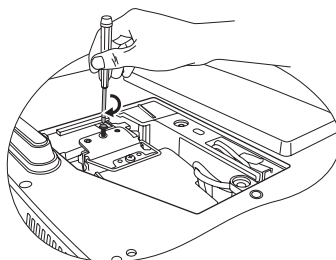

11. Replace the lamp cover on the projector.

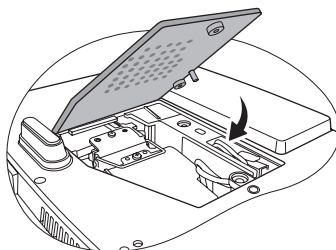

12. Tighten the screws that secure the lamp cover.



• **Loose screw may cause a bad connection, which could result in malfunction.**

• **Do not over tighten the screws.**

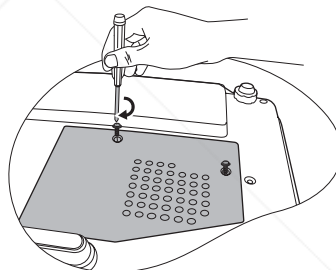

13. Restart the projector.



• **Do not turn the power on with the lamp cover removed.**

### Resetting the lamp timer

14. After the startup logo, open the On-Screen Display (OSD) menu. Go to the **SYSTEM SETUP: Advanced > Lamp Settings** menu. Press **Mode/Enter**. The **Lamp Settings** page displays. Press **▼** to highlight **Reset lamp timer** and press **Mode/Enter**. A warning message displays asking if you want to reset the lamp timer. Highlight **Reset** and press **Mode/Enter**. The lamp time will be reset to '0'.

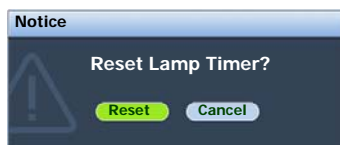

• **Do not reset if the lamp is not new or replaced as this could cause damage.**

# Indicators

Light			Status & Description
Power	Temp	Lamp	
<b>Power events</b>			
<b>Orange</b>	<b>Orange</b>	<b>Orange</b>	The projector has just been connected to a power outlet.
<b>Orange</b>	<b>Off</b>	<b>Off</b>	Stand-by mode
<b>Green Flashing</b>	<b>Off</b>	<b>Off</b>	Powering up
<b>Green</b>	<b>Off</b>	<b>Off</b>	Normal operation
<b>Orange Flashing</b>	<b>Off</b>	<b>Off</b>	<ol style="list-style-type: none"> <li>The projector needs 90 seconds to cool down as it was abnormally shut down without the normal cooling down process. <b>Or</b></li> <li>The projector needs to cool for 90 seconds after the power is turned off.</li> </ol>
<b>Orange Flashing</b>	<b>Off</b>	<b>Off</b>	The projector has shutdown automatically. If you try to re-start the projector, it will shutdown again. Please contact your dealer for assistance.
<b>Lamp events</b>			
<b>Orange Flashing</b>	<b>Off</b>	<b>Red</b>	The projector has shutdown automatically. If you try to re-start the projector, it will shutdown again. Please contact your dealer for assistance.
<b>Off</b>	<b>Off</b>	<b>Red</b>	<ol style="list-style-type: none"> <li>The projector needs 90 seconds to cool down. <b>Or</b></li> <li>Please contact your dealer for assistance.</li> </ol>
<b>Thermal events</b>			
<b>Off</b>	<b>Red</b>	<b>Off</b>	The projector has shutdown automatically. If you try to re-start the projector, it will shutdown again. Please contact your dealer for assistance.
<b>Off</b>	<b>Red</b>	<b>Red</b>	
<b>Off</b>	<b>Red</b>	<b>Green</b>	
<b>Off</b>	<b>Red</b>	<b>Orange</b>	
<b>Red</b>	<b>Red</b>	<b>Red</b>	
<b>Red</b>	<b>Red</b>	<b>Green</b>	
<b>Red</b>	<b>Red</b>	<b>Orange</b>	
<b>Green</b>	<b>Red</b>	<b>Red</b>	
<b>Green</b>	<b>Red</b>	<b>Green</b>	
<b>Green</b>	<b>Red</b>	<b>Orange</b>	
<b>Orange</b>	<b>Red</b>	<b>Red</b>	
<b>Orange</b>	<b>Red</b>	<b>Green</b>	
<b>Orange</b>	<b>Red</b>	<b>Orange</b>	
<b>Off</b>	<b>Green</b>	<b>Red</b>	
<b>Off</b>	<b>Green</b>	<b>Green</b>	



Fix Your DLP.com

DiscountMerchant.com (800) 281-8860

THE TRUSTED SOURCE FOR PROJECTOR LAMPS AND ACCESSORIES

# Troubleshooting

## ⑦ The projector does not turn on.

Cause	Remedy
There is no power from the power cable.	Plug the power cord into the AC inlet on the projector, and plug the power cord into the power outlet. If the power outlet has a switch, make sure that it is switched on.
Attempting to turn the projector on again during the cooling process.	Wait until the cooling down process has completed.

## ⑦ No picture

Cause	Remedy
The video source is not turned on or connected correctly.	Turn the video source on and check that the signal cable is connected correctly.
The projector is not correctly connected to the input signal device.	Check the connection.
The input signal has not been correctly selected.	Select the correct input signal with the <b>SOURCE</b> key on the projector or remote control.
The lens cover is still closed.	Open the lens cover.

## ⑦ Blurred image

Cause	Remedy
The projection lens is not correctly focused.	Adjust the focus of the lens using the focus ring.
The projector and the screen are not aligned properly.	Adjust the projection angle and direction as well as the height of the unit if necessary.
The lens cover is still closed.	Open the lens cover.

## ⑦ Remote control does not work

Cause	Remedy
The battery is out of power.	Replace the battery with new one.
There is an obstacle between the remote control and the projector.	Remove the obstacle.
You are too far away from the projector.	Stand within 8 meters (26 feet) of the projector.

## ⑦ The password is incorrect

Cause	Remedy
You do not remember the password.	Please see <a href="#">"Entering the password recall procedure"</a> on page 27 for details.



FixYourDr.com  
powered by

Discount-Merchant.com (800) 281-8860  
THE T... SOURCE FOR PROJECTOR PARTS AND ACCESSORIES

# Specifications

## Projector specifications

 All specifications are subject to change without notice.

<b>General</b>			
Product name	Digital Projector		
Model name	MP512	MP513	MP522
<b>Optical</b>			
Resolution	800 x 600 SVGA	800 x 600 SVGA	1024 x 768 XGA
Display system	1-CHIP DMD		
Lens F/Number	F = 2.6, f = 22 mm	F = 2.6 to 2.8, f = 21 to 23 mm	F = 2.6 to 2.8, f = 21 to 23 mm
Lamp	185 W lamp	200 W lamp	185 W lamp
<b>Electrical</b>			
Power supply	AC100–240V, 3 A, 50/60 Hz (Automatic)		
Power consumption	280 W (Max)	285 W (Max)	280 W (Max)
<b>Mechanical</b>			
Dimensions	255 mm (W) x 90 mm (H) x 214 mm (D)		
Weight	4.9 lbs (2.2 Kg)		
<b>Input terminal</b>			
Computer input			
RGB input	D-Sub 15-pin (female) x 1		
Video signal input			
S-VIDEO	Mini DIN 4-pin port x 1		
VIDEO	RCA jack x 1		
SD/HDTV signal input	Analog – D-Sub <-> Component RCA jack x 3 (through RGB input)		
<b>Output terminal</b>			
RGB output	D-Sub 15-pin (female) x 1		
<b>Control terminal</b>			
RS-232 serial control	9 pin x 1		
<b>Environmental Requirements</b>			
Operating temperature	0°C–40°C at sea level		
Operating relative humidity	10%–90% (without condensation)		
Operating altitude	• 0–1499 m at 0°C–35°C • 1500–3000 m at 0°C–30°C (with High Altitude Mode on)		

FixYourDLP.com  
Discounter Merchants (800) 281-8860  
THE TRUSTED SOURCE FOR PROJECTOR LAMP AND ACCESSORIES



# Dimensions

255 mm (W) x 90 mm (H) x 214 mm (D)

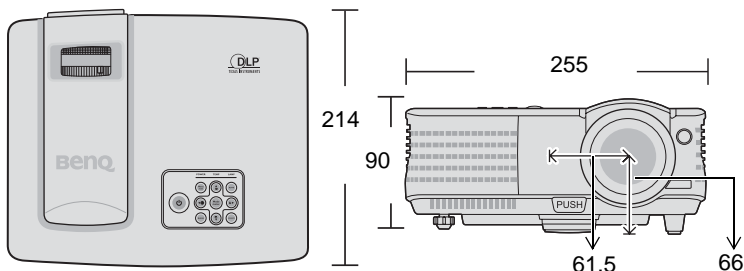

# Timing chart

## Supported timing for PC input

Resolution	Horizontal Frequency (kHz)	Vertical Frequency (Hz)	Pixel Frequency (MHz)	Mode
640 x 480	31.469	59.940	25.175	VGA_60
	37.861	72.809	31.500	VGA_72
	37.500	75.000	31.500	VGA_75
	43.269	85.008	36.000	VGA_85
720 x 400	31.469	70.087	28.3221	720 x 400_70
800 x 600	37.879	60.317	40.000	SVGA_60
	48.077	72.188	50.000	SVGA_72
	46.875	75.000	49.500	SVGA_75
	53.674	85.061	56.250	SVGA_85
	48.363	60.004	65.000	XGA_60
1024 x 768	56.476	70.069	75.000	XGA_70
	60.023	75.029	78.750	XGA_75
	68.667	84.997	94.500	XGA_85
	1280 x 960	60.000	60.000	108.000
640 x 480@67Hz	35.000	66.667	30.240	MAC13
832 x 624@75Hz	49.722	74.546	57.280	MAC16
1024 x 768@75Hz	60.241	75.020	80.000	MAC19
1152 x 870@75Hz	68.68	75.020	100.00	MAC21
1280 x 800	49.65	59.96	83.458	SXGA_60
1280 x 1024	63.981	60.020	108.000	SXGA3_60



**Discount-Merchant.com (800) 281-8860**  
**THE TRUSTED SOURCE FOR PROJECTOR LAMPS AND ACCESSORIES**

## Supported timing for Component-YPbPr input

Signal Format	Horizontal Frequency (kHz)	Vertical Frequency (Hz)
480i(525i)@60Hz	15.73	59.94
480p(525p)@60Hz	31.47	59.94
576i(625i)@50Hz	15.63	50.00
576p(625p)@50Hz	31.25	50.00
720p(750p)@60Hz	45.00	60.00
720p(750p)@50Hz	37.50	50.00
1080i(1125i)@60Hz	33.75	60.00
1080i(1125i)@50Hz	28.13	50.00

 Displaying a 1080i(1125i)@60Hz or 1080i(1125i)@50Hz signal may result in slight image vibration.

## Supported timing for Video and S-Video inputs

Video mode	Horizontal Frequency (kHz)	Vertical Frequency (Hz)	Color sub-carrier Frequency (MHz)
NTSC	15.73	60	3.58
PAL	15.63	50	4.43
SECAM	15.63	50	4.25 or 4.41
PAL-M	15.73	60	3.58
PAL-N	15.63	50	3.58
PAL-60	15.73	60	4.43
NTSC4.43	15.73	60	4.43



**Discount-Merchant.com (800) 281-8860**  
**THE TRUSTED SOURCE FOR PROJECTOR LAMPS AND ACCESSORIES**

# Warranty and Copyright information

## Limited warranty

BenQ warrants this product against any defects in material and workmanship, under normal usage and storage.

Proof of purchase date will be required with any warranty claim. In the event this product is found to be defective within the warranty period, BenQ's only obligation and your exclusive remedy shall be replacement of any defective parts (labor included). To obtain warranty service, immediately notify the dealer from which you purchased the product of any defects.

Important: The above warranty shall be void if the customer fails to operate the product in accordance with BenQ's written instructions, especially the ambient humidity must be in-between 10% and 90%, temperature in-between 0°C and 35°C, altitude lower than 4920 feet, and avoiding to operate the projector in a dusty environment. This warranty gives you specific legal rights, and you may have other rights which vary from country to country.

For other information, please visit [www.BenQ.com](http://www.BenQ.com).

## Copyright

Copyright 2008 by BenQ Corporation. All rights reserved. No part of this publication may be reproduced, transmitted, transcribed, stored in a retrieval system or translated into any language or computer language, in any form or by any means, electronic, mechanical, magnetic, optical, chemical, manual or otherwise, without the prior written permission of BenQ Corporation.

## Disclaimer

BenQ Corporation makes no representations or warranties, either expressed or implied, with respect to the contents hereof and specifically disclaims any warranties, merchantability or fitness for any particular purpose. Further, BenQ Corporation reserves the right to revise this publication and to make changes from time to time in the contents hereof without obligation to notify any person of such revision or changes.

\*DLP, Digital Micromirror Device and DMD are trademarks of Texas Instruments. Others are copyrights of their respective companies or organizations.



**Discount-Merchant.com (800) 281-8860**  
**THE TRUSTED SOURCE FOR PROJECTOR LAMPS AND ACCESSORIES**

# Regulation statements

## FCC statement

**CLASS B:** This equipment generates, uses and can radiate radio frequency energy and, if not installed and used in accordance with the instructions, may cause harmful interference to radio communications. However, there is no guarantee that interference will not occur in a particular installation. If this equipment does cause harmful interference to radio or television reception, which can be determined by turning the equipment off and on, the user is encouraged to try to correct the interference by one or more of the following measures:

- Reorient or relocate the receiving antenna.
- Increase the distance between the equipment and receiver.
- Connect the equipment into an outlet on a circuit different from that to which the receiver is connected.
- Consult the dealer or an experienced radio/TV technician for help.

## EEC statement

This machine was tested against the 89/336/EEC (European Economic Community) for EMC (Electronic Magnetic Compatibility) and fulfills these requirements.

## WEEE directive

**Disposal of Waste Electrical and Electronic Equipment by users in private households in the European Union.**

This symbol on the product or on the packaging indicates that this can not be disposed of as household waste. You must dispose of your waste equipment by handing it over to the applicable take-back scheme for the recycling of electrical and electronic equipment. For more information about recycling of this equipment, please contact your city office, the shop where you purchased the equipment or your household waste disposal service. The recycling of materials will help to conserve natural resources and ensure that it is recycled in a manner that protects human health and environment.



**Discount-Merchant.com (800) 281-8860**  
**THE TRUSTED SOURCE FOR PROJECTOR LAMPS AND ACCESSORIES**



# Disclaimer

This user manual is provided as a free service by FixYourDLP.com. FixYourDLP is in no way responsible for the content of this manual, nor do we guarantee its accuracy. FixYourDLP does not make any claim of copyright and all copyrights remain the property of their respective owners.

About FixYourDLP.com

FixYourDLP.com (<http://www.fixyourdpl.com>) is the World's #1 resource for media product news, reviews, do-it-yourself guides, and manuals.

Informational Blog: <http://www.fixyourdpl.com>

Video Guides: <http://www.fixyourdpl.com/guides>

User Forums: <http://www.fixyourdpl.com/forum>

FixYourDLP's Fight Against Counterfeit Lamps:

<http://www.fixyourdpl.com/counterfeits>

## Sponsors:

RecycleYourLamp.org – Free lamp recycling services for used lamps:

<http://www.recycleyourlamp.org>

Lamp Research - The trusted 3rd party lamp research company:

<http://www.lampresearch.com>

Discount-Merchant.com – The worlds largest lamp distributor:

<http://www.discount-merchant.com>



**FixYourDLP.com**

Sponsored by 