



# Disclaimer

This user manual is provided as a free service by FixYourDLP.com. FixYourDLP is in no way responsible for the content of this manual, nor do we guarantee its accuracy. FixYourDLP does not make any claim of copyright and all copyrights remain the property of their respective owners.

About FixYourDLP.com

FixYourDLP.com (<http://www.fixyourdlp.com>) is the World's #1 resource for media product news, reviews, do-it-yourself guides, and manuals.

Informational Blog: <http://www.fixyourdlp.com>

Video Guides: <http://www.fixyourdlp.com/guides>

User Forums: <http://www.fixyourdlp.com/forum>

FixYourDLP's Fight Against Counterfeit Lamps:

<http://www.fixyourdlp.com/counterfeits>

## Sponsors:

RecycleYourLamp.org – Free lamp recycling services for used lamps:

<http://www.recycleyourlamp.org>

Lamp Research - The trusted 3rd party lamp research company:

<http://www.lampresearch.com>

Discount-Merchant.com – The worlds largest lamp distributor:

<http://www.discount-merchant.com>



**FixYourDLP.com**

Sponsored by 

*Portable Projector*

# ***NP60/NP50/NP40***

---

*User's Manual*



**Discount-Merchant.com (800) 281-8860**  
**THE TRUSTED SOURCE FOR PROJECTOR LAMPS AND ACCESSORIES**

The projector's model name indicated on the projector's label is NP60, NP50, NP40, NP60G, NP50G, and NP40G respectively. All six models are referred to as NP60, NP50 and NP40 throughout the user's manual except some of the specifications pages.

- DLP is a trademark of Texas Instruments.
  - IBM is a trademark or registered trademark of International Business Machines Corporation.
  - Macintosh, Mac OS X and PowerBook are trademarks of Apple Computer, Inc., registered in the U.S. and other countries.
  - Windows, Windows 98, Windows Me, Windows XP or Windows 2000 are trademarks or registered trademarks of Microsoft Corporation.
- Other product and company names mentioned in this user's manual may be the trademarks or registered trademarks of their respective holders.

#### NOTES

- (1) The contents of this user's manual may not be reprinted in part or whole without permission.
- (2) The contents of this user's manual are subject to change without notice.
- (3) Great care has been taken in the preparation of this user's manual; however, should you notice any questionable points, errors or omissions, please contact us.
- (4) Notwithstanding article (3), NEC will not be responsible for any claims on loss of profit or other matters deemed to result from using the Projector.

# Important Information

## Safety Cautions

### Precautions

Please read this manual carefully before using your NEC NP60/NP50/NP40 projector and keep the manual handy for future reference. Your serial number is located on the bottom of your projector. Record it here:

#### CAUTION



To turn off main power, be sure to remove the plug from power outlet. The power outlet socket should be installed as near to the equipment as possible, and should be easily accessible.

#### CAUTION



TO PREVENT SHOCK, DO NOT OPEN THE CABINET. THERE ARE HIGH-VOLTAGE COMPONENTS INSIDE. REFER SERVICING TO QUALIFIED SERVICE PERSONNEL.



This symbol warns the user that uninsulated voltage within the unit may be sufficient to cause electrical shock. Therefore, it is dangerous to make any kind of contact with any part inside of the unit.



This symbol alerts the user that important information concerning the operation and maintenance of this unit has been provided. The information should be read carefully to avoid problems.

**WARNING:** TO PREVENT FIRE OR SHOCK, DO NOT EXPOSE THIS UNIT TO RAIN OR MOISTURE. DO NOT USE THIS UNIT'S PLUG WITH AN EXTENSION CORD OR IN AN OUTLET UNLESS ALL THE PRONGS CAN BE FULLY INSERTED.

### DOC Compliance Notice (for Canada only)

This Class B digital apparatus meets all requirements of the Canadian Interference-Causing Equipment Regulations.

### Machine Noise Information Regulation - 3. GPSGV,

The highest sound pressure level is less than 70 dB (A) in accordance with EN ISO 7779.

### Disposing of your used product



EU-wide legislation as implemented in each Member State requires that used electrical and electronic products carrying the mark (left) must be disposed of separately from normal household waste. This includes projectors and their electrical accessories or lamps. When you dispose of such products, please follow the guidance of your local authority and/or ask the shop where you purchased the product.

After collecting the used products, they are reused and recycled in a proper way. This effort will help us reduce the wastes as well as the negative impact such as mercury contained in a lamp to the human health and the environment at the minimum level.

The mark on the electrical and electronic products only applies to the current European Union Member States.

FixYourDLP.com  
Discount-Merchant.com (800) 281-8860  
THE TRUSTED SOURCE FOR PROJECTOR LAMPS AND ACCESSORIES

#### WARNING TO CALIFORNIA RESIDENTS:

Handling the cables supplied with this product will expose you to lead, a chemical known to the State of California to cause birth defects or other reproductive harm. **WASH HANDS AFTER HANDLING.**

## RF Interference (for USA only)

### WARNING

The Federal Communications Commission does not allow any modifications or changes to the unit EXCEPT those specified by NEC Corporation of America in this manual. Failure to comply with this government regulation could void your right to operate this equipment. This equipment has been tested and found to comply with the limits for a Class B digital device, pursuant to Part 15 of the FCC Rules. These limits are designed to provide reasonable protection against harmful interference in a residential installation. This equipment generates, uses, and can radiate radio frequency energy and, if not installed and used in accordance with the instructions, may cause harmful interference to radio communications. However, there is no guarantee that interference will not occur in a particular installation.

If this equipment does cause harmful interference to radio or television reception, which can be determined by turning the equipment off and on, the user is encouraged to try to correct the interference by one or more of the following measures:

- Reorient or relocate the receiving antenna.
- Increase the separation between the equipment and receiver.
- Connect the equipment into an outlet on a circuit different from that to which the receiver is connected.
- Consult the dealer or an experienced radio / TV technician for help.

For UK only: In UK, a BS approved power cable with moulded plug has a Black (five Amps) fuse installed for use with this equipment. If a power cable is not supplied with this equipment please contact your supplier.

## Important Safeguards

These safety instructions are to ensure the long life of your projector and to prevent fire and shock. Please read them carefully and heed all warnings.

### Installation

- Do not place the projector in the following conditions:
  - on an unstable cart, stand, or table.
  - near water, baths, or damp rooms.
  - in direct sunlight, near heaters, or heat radiating appliances.
  - in a dusty, smoky or steamy environment.
  - on a sheet of paper or cloth, rugs or carpets.
- If you wish to have the projector installed on the ceiling:
  - Do not attempt to install the projector yourself.
  - The projector must be installed by qualified technicians in order to ensure proper operation and reduce the risk of bodily injury.
  - In addition, the ceiling must be strong enough to support the projector and the installation must be in accordance with any local building codes.
  - Please consult your dealer for more information.

### Place the projector in a horizontal position

The tilt angle of the projector should not exceed 10 degrees, nor should the projector be installed in any way other than the desktop and ceiling mount, otherwise lamp life could decrease dramatically.



### **Fire and Shock Precautions**

- Ensure that there is sufficient ventilation and that vents are unobstructed to prevent the build-up of heat inside your projector. Allow at least 4 inches (10cm) of space between your projector and a wall.
- Do not try to touch the ventilation outlet on the right front (when seen from the front) as it can become heated while the projector is turned on and immediately after the projector is turned off.
- Prevent foreign objects such as paper clips and bits of paper from falling into your projector. Do not attempt to retrieve any objects that might fall into your projector. Do not insert any metal objects such as a wire or screwdriver into your projector. If something should fall into your projector, disconnect it immediately and have the object removed by a qualified service personnel.
- Do not place any objects on top of the projector.
- Do not touch the power plug during a thunderstorm. Doing so can cause electrical shock or fire.
- The projector is designed to operate on a power supply of 100-240V AC 50/60 Hz (NP60/NP50/NP40) or 200-240V AC 50/60 Hz (NP60G/NP50G/NP40G). Ensure that your power supply fits this requirement before attempting to use your projector.
- Do not look into the lens while the projector is on. Serious damage to your eyes could result.
- Keep any items such as magnifying glass out of the light path of the projector. The light being projected from the lens is extensive, therefore any kind of abnormal objects that can redirect light coming out of the lens, can cause unpredictable outcome such as fire or injury to the eyes.
- Do not cover the lens with the black lens cap or equivalent while the projector is on. Doing so can lead to melting of the cap and possibly burning your hands due to the heat emitted from the light output.
- Do not place any objects, which are easily affected by heat, in front of the projector lens or a projector exhaust vent.  
Doing so could lead to the object melting or getting your hands burned from the heat that is emitted from the light output and exhaust.
- Handle the power cable carefully. A damaged or frayed power cable can cause electric shock or fire.
  - Do not use any power cables than the supplied one.
  - Do not bend or tug the power cable excessively.
  - Do not place the power cable under the projector, or any heavy object.
  - Do not cover the power cable with other soft materials such as rugs.
  - Do not heat the power cable.
  - Do not handle the power plug with wet hands.
- Turn off the projector, unplug the power cable and have the object removed by a qualified NEC service personnel under the following conditions:
  - When the power cable or plug is damaged or frayed.
  - If liquid has been spilled into the projector, or if it has been exposed to rain or water.
  - If the projector does not operate normally when you follow the instructions described in this user's manual.
  - If the projector has been dropped or the cabinet has been damaged.
  - If the projector exhibits a distinct change in performance, indicating a need for service.
  - If the projector is not to be used for an extended period of time.
- Disconnect the power cable and any other cables before carrying the projector.
- Turn off the projector and unplug the power cable before cleaning the cabinet or replacing the lamp.

#### **CAUTION**

Do not use the tilt-foot for purposes other than originally intended. Misuses such as using the tilt foot to carry or hang (from the wall or ceiling) the projector can cause damage to the projector.

Do not send the projector in the soft case by parcel delivery service or cargo shipment. The projector inside the soft case could be damaged.

- Select [High] in Fan mode if you continue to use the projector for consecutive days. (From the menu, select [Setup - Options] → [Fan Mode] → [High]).
- Do not turn off the AC power for 60 seconds after the lamp is turned on and while the POWER indicator is blinking green.

Doing so could cause premature lamp failure.

 **Remote Control Precautions**

- Handle the remote control carefully.
- If the remote control gets wet, wipe it dry immediately.
- Avoid excessive heat and humidity.
- Do not heat, take apart, or throw batteries into fire.
- If you will not be using the remote control for a long time, remove the batteries.
- Ensure that you have the batteries' polarity (+/-) aligned correctly.
- Do not use new and old batteries together, or use different types of batteries together.
- Dispose of used batteries according to your local regulations.

**Lamp Replacement**

- To replace the lamp, follow all instructions provided on page 48 to 51.
- Be sure to replace the lamp when the message [**The lamp has reached the end of its usable life. Please replace the lamp.**] appears. If you continue to use the lamp after the lamp has reached the end of its usable life, the lamp bulb may shatter, and pieces of glass may be scattered in the lamp case. Do not touch them as the pieces of glass may cause injury.

If this happens, contact your dealer for lamp replacement.

**A Lamp Characteristic**

The projector has a high-pressure mercury lamp as a light source.

A lamp has a characteristic that its brightness gradually decreases with age. Also repeatedly turning the lamp on and off will increase the possibility of its lower brightness.

 **CAUTION:**

When removing the lamp from a ceiling-mounted projector, make sure that no one is under the projector. Glass fragments could fall if the lamp has been burned out.



**Discount-Merchant.com (800) 281-8860**  
**THE TRUSTED SOURCE FOR PROJECTOR LAMPS AND ACCESSORIES**

# Table of Contents

---

<b>Important Information</b> .....	i
<b>1. Introduction</b> .....	1
<b>1</b> What's in the Box? .....	1
<b>2</b> Introduction to the Projector .....	2
<b>3</b> Part Names of the Projector .....	4
Top Features .....	6
Terminal Panel Features .....	6
<b>4</b> Part Names of the Remote Control.....	7
Battery Installation .....	8
Remote Control Precautions.....	8
Operating Range for Wireless Remote Control .....	8
<b>2. Installation and Connections</b> .....	9
<b>1</b> Setting Up the Screen and the Projector.....	9
Selecting a Location.....	9
Throw Distance and Screen Size.....	10
<b>2</b> Making Connections .....	12
Connecting Your PC or Macintosh Computer .....	12
Connecting Your DVD Player with Component Output .....	13
Connecting Your VCR or Laser Disc Player.....	14
Connecting the Supplied Power Cable .....	15
<b>3. Projecting an Image (Basic Operation)</b> .....	16
<b>1</b> Turning on the Projector .....	16
Note on Startup Screen (Menu Language Select screen) .....	17
<b>2</b> Selecting a Source .....	18
<b>3</b> Adjusting the Picture Size and Position .....	20
<b>4</b> Adjusting Focus Manually.....	24
<b>5</b> Correcting Keystone Distortion Manually .....	25
<b>6</b> Optimizing RGB Picture Automatically .....	26
<b>7</b> Turning off the Projector .....	27
<b>8</b> After Use.....	27



**Discount-Merchant.com (800) 281-8860**  
**THE TRUSTED SOURCE FOR PROJECTOR LAMPS AND ACCESSORIES**



<b>4. Convenient Features</b> .....	28
<b>1</b> Turning Off the Image .....	28
<b>2</b> Freezing a Picture .....	28
<b>3</b> Changing Lamp Mode .....	28
<b>4</b> Preventing the Unauthorized Use of the Projector .....	28
<b>5</b> Using the Optional Remote Mouse Receiver (NP01MR) .....	31
<b>5. Using On-Screen Menu</b> .....	33
<b>1</b> Using the Menus .....	33
<b>2</b> Menu Elements .....	35
<b>3</b> List of Menu Items .....	36
<b>4</b> Menu Descriptions & Functions [Picture] .....	38
<b>5</b> Menu Descriptions & Functions [Image Options] .....	39
<b>6</b> Menu Descriptions & Functions [Setup] .....	41
[Setup - General] .....	41
[Setup - Installation] .....	42
[Setup - Options] .....	44
<b>7</b> Menu Descriptions & Functions [Information] .....	45
<b>8</b> Menu Descriptions & Functions [Reset] .....	46
<b>6. Maintenance</b> .....	47
<b>1</b> Cleaning the Lens and the Focus Sensor .....	47
<b>2</b> Cleaning the Cabinet .....	47
<b>3</b> Replacing the Lamp and the Cooling Pump .....	48
<b>7. Appendix</b> .....	52
<b>1</b> Troubleshooting .....	52
<b>2</b> Specifications .....	55
<b>3</b> Cabinet Dimensions .....	57
<b>4</b> Pin Assignments of D-Sub COMPUTER Input Connector .....	58
<b>5</b> Compatible Input Signal List .....	59
<b>6</b> PC Control Codes and Cable Connection .....	60
<b>7</b> Troubleshooting Check List .....	61
<b>8</b> Travel Care Guide .....	63



**Discount-Merchant.com (800) 281-8860**  
**THE TRUSTED SOURCE FOR PROJECTOR LAMPS AND ACCESSORIES**

# 1. Introduction

## ① What's in the Box?

Make sure your box contains everything listed. If any pieces are missing, contact your dealer. Please save the original box and packing materials if you ever need to ship your projector.

Projector

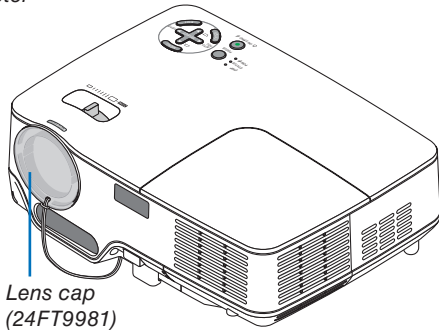

Lens cap  
(24FT9981)

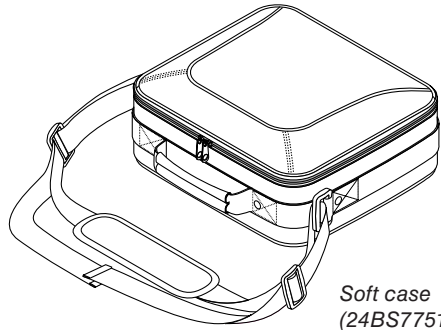

Soft case  
(24BS7751)

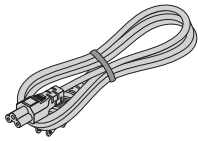

Power cable  
(US: 7N080216)  
(EU: 7N080017)

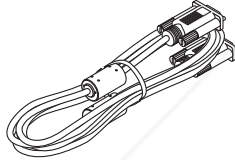

VGA signal cable  
(7N520054)

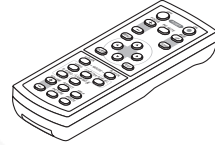

Remote control  
(7N900681)

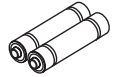

Batteries (AAA×2)

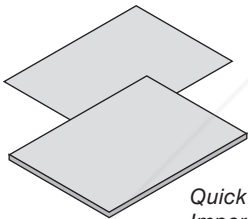

Quick Setup Guide  
Important Information

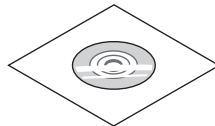

CD-ROM  
User's manual

**For North America only**  
Registration card  
Limited warranty  
**For Europe only**  
Guarantee policy



**Discount-Merchant.com (800) 281-8860**  
**THE TRUSTED SOURCE FOR PROJECTOR LAMPS AND ACCESSORIES**

## ② Introduction to the Projector

This section introduces you to your new projector and describes the features and controls.

### **Congratulations on Your Purchase of the Projector**

This DLP™ projector is one of the very best projectors available today. The projector enables you to project precise images up to 300 inches (measured diagonally) from your PC or Macintosh computer (desktop or notebook), VCR, DVD player, document camera, or a laser disc player.

You can use the projector on a tabletop or cart, you can use the projector to project images from behind the screen, and the projector can be permanently mounted on a ceiling\*<sup>1</sup>. The remote control can be used wirelessly.

\*<sup>1</sup> Do not attempt to mount the projector on a ceiling yourself.

The projector must be installed by qualified technicians in order to ensure proper operation and reduce the risk of bodily injury.

In addition, the ceiling must be strong enough to support the projector and the installation must be in accordance with any local building codes. Please consult your dealer for more information.

### **Features you'll enjoy:**

- Auto Focus function

When you turn on the power, change the zoom or reposition the projector, the Auto Focus function will work instantly.

The focus sensor on the projector detects the distance to the screen and automatically adjusts the focus of an image as well as reducing the required set-up time.

- Auto vertical keystone correction up to +/- 16 degrees
- Built-in Wall Color Correction presets provide for adaptive color correction when projecting onto non-white screen material
- Direct Power Off  
The projector has a feature called "Direct Power Off". This feature allows you to unplug the projector when projecting an image.
- HDTV (1080i, 720p) and SDTV (576p, 480p) compatibility
- Integrated de-interlace video processing technology
- Display popular wide screen and full screen aspect ratios – 16:9 and 4:3
- High resolution display - up to UXGA compatible, XGA native resolution.
- Multiple video mode selections (depending on your source)
- Safety protect by Security function  
Security feature prevents unauthorized individuals from displaying images.
- You can control the projector with a PC or control system using the PC Control port.
- Easy set up and operation

The contemporary cabinet design is light, compact and complements any office, boardroom or Auditorium.

Sponsored by 

**Discount-Merchant.com (800) 281-8860**  
**THE TRUSTED SOURCE FOR PROJECTOR LAMPS AND ACCESSORIES**

### **About this user's manual**

The fastest way to get started is to take your time and do everything right the first time. Take a few minutes now to review the user's manual. This may save you time later on. At the beginning of each section of the manual you'll find an overview. If the section doesn't apply, you can skip it.



**Discount-Merchant.com (800) 281-8860**  
**THE TRUSTED SOURCE FOR PROJECTOR LAMPS AND ACCESSORIES**

### 3 Part Names of the Projector

#### Front/Top

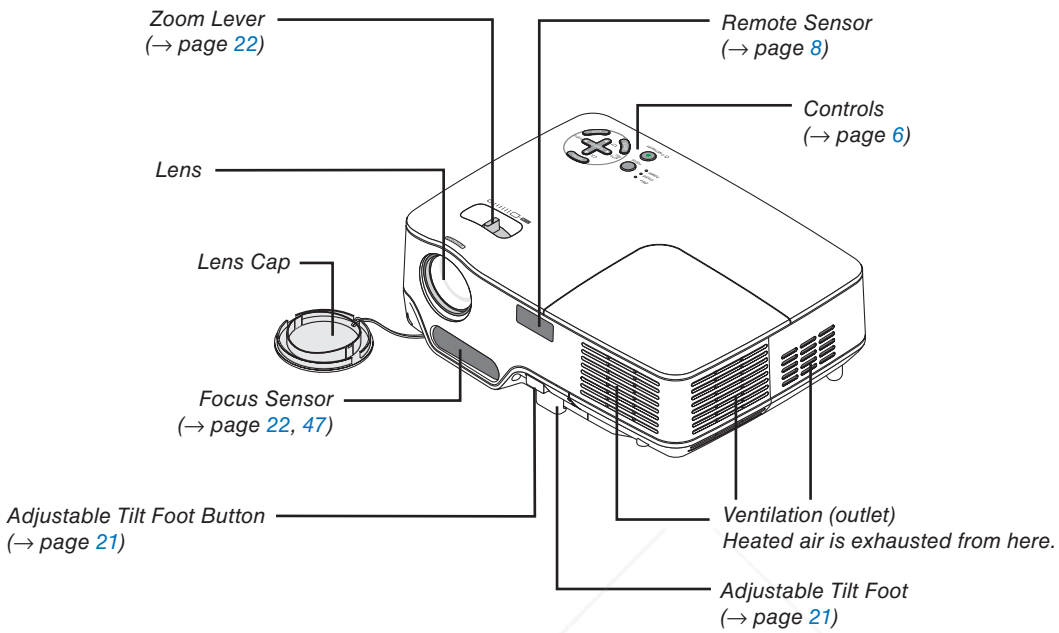

#### Rear

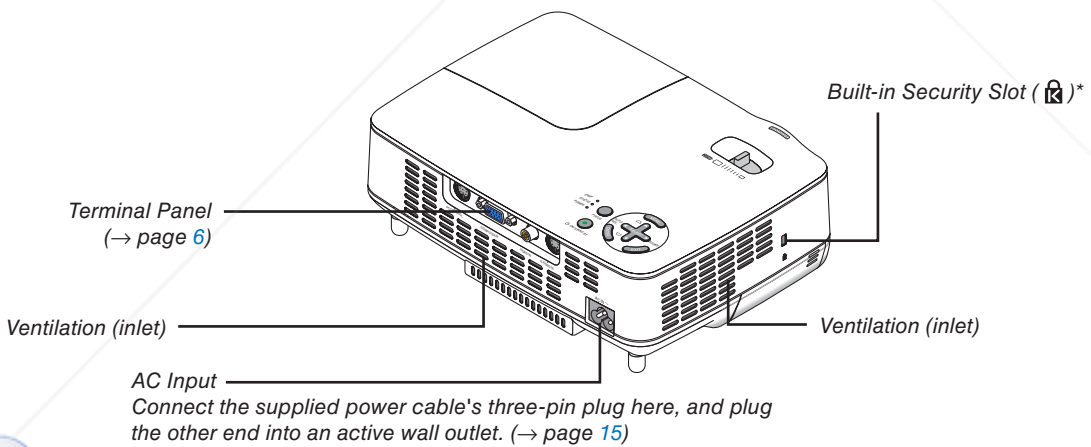

**FixYourDLP.com**  
Sponsored by DM

This security slot supports the MicroSaver® Security System. MicroSaver® is a registered trademark of Kensington Microwave Inc. The logo is trademarked and owned by Kensington Microwave Inc. (800) 261-8860

**Discount-Merchant.com**

**THE TRUSTED SOURCE FOR PROJECTOR LAMPS AND ACCESSORIES**

**Bottom**

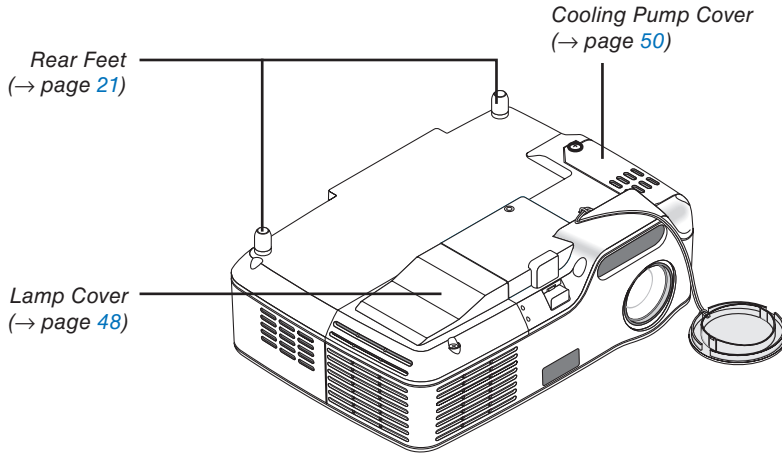

## Top Features

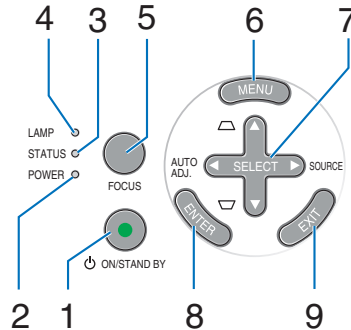

1. **POWER Button (ON / STAND BY) (⏻)** (→ page 16, 27)
2. **POWER Indicator** (→ page 15, 16, 27, 52)
3. **STATUS Indicator** (→ page 52)
4. **LAMP Indicator** (→ page 48, 52)
5. **FOCUS Button** (→ page 24)
6. **MENU Button** (→ page 33)
7. **SELECT ▲▼◀▶ / SOURCE ▶ / AUTO ADJ ◀▲ / Keystone ▲▼ Buttons** (→ page 18, 25, 26)
8. **ENTER Button**
9. **EXIT Button**

## Terminal Panel Features

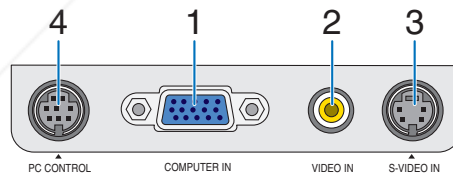

1. **COMPUTER IN/ Component Input Connector (Mini D-Sub 15 Pin)** (→ page 12, 13)
2. **VIDEO IN Connector (RCA)** (→ page 14)
3. **S-VIDEO IN Connector (Mini DIN 4 Pin)** (→ page 14)
4. **PC CONTROL Port (Mini DIN 8 Pin)** (→ page 60)  
Use this port to connect a PC or control system. This enables you to control the projector using serial communication protocol. If you are writing your own program, typical PC control codes are on page 60.



**Discount-Merchant.com (800) 281-8860**  
THE TRUSTED SOURCE FOR PROJECTOR LAMPS AND ACCESSORIES

## 4 Part Names of the Remote Control

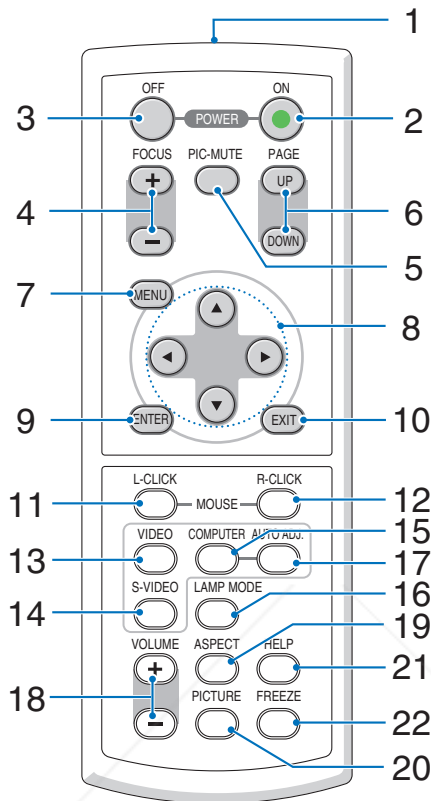

- |   |   |
|---|---|
| 1. Infrared Transmitter (→ page 8)        | 12. R-CLICK MOUSE Button* (→ page 31)                   |
| 2. POWER ON Button (→ page 16)            | 13. VIDEO Button (→ page 18)                            |
| 3. POWER OFF Button (→ page 27)           | 14. S-VIDEO Button (→ page 18)                          |
| 4. FOCUS (+) (-) Button (→ page 24)       | 15. COMPUTER Button (→ page 18)                         |
| 5. PIC-MUTE Button (→ page 28)            | 16. LAMP MODE Button (→ page 28)                        |
| 6. PAGE (UP) / (DOWN) Button* (→ page 31) | 17. AUTO ADJ. Button (→ page 26)                        |
| 7. MENU Button (→ page 33)                | 18. VOLUME (+) (-) Button (Not available on this model) |
| 8. SELECT Buttons                         | 19. ASPECT Button (→ page 39)                           |
| 9. ENTER Button                           | 20. PICTURE Button (→ page 38, 39)                      |
| 10. EXIT Button                           | 21. HELP Button (→ page 45)                             |
| 11. L-CLICK MOUSE Button* (→ page 31)     | 22. FREEZE Button (→ page 28)                           |

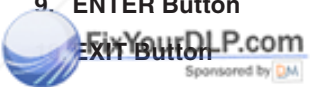

Discount-Merchant.com (800) 281-8860

THE TRUSTED SOURCE FOR PROJECTOR LAMPS AND ACCESSORIES

\* Available only when the optional remote mouse receiver is connected with your computer.



## Battery Installation

- 1** Press firmly and slide the battery cover off.

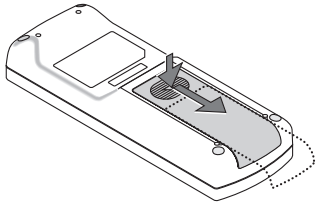

- 2** Install new batteries (AAA). Ensure that you have the batteries' polarity (+/-) aligned correctly.

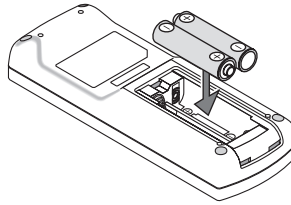

- 3** Slip the cover back over the batteries until it snaps into place. Do not mix different types of batteries or new and old batteries.

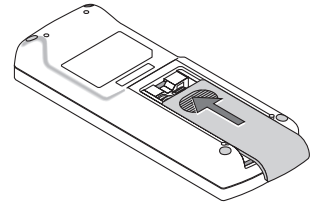

## Remote Control Precautions

- Handle the remote control carefully.
- If the remote control gets wet, wipe it dry immediately.
- Avoid excessive heat and humidity.
- Do not heat, take apart, or throw batteries into fire.
- If you will not be using the remote control for a long time, remove the batteries.
- Ensure that you have the batteries' polarity (+/-) aligned correctly.
- Do not use new and old batteries together, or use different types of batteries together.
- Dispose of used batteries according to your local regulations.

## Operating Range for Wireless Remote Control

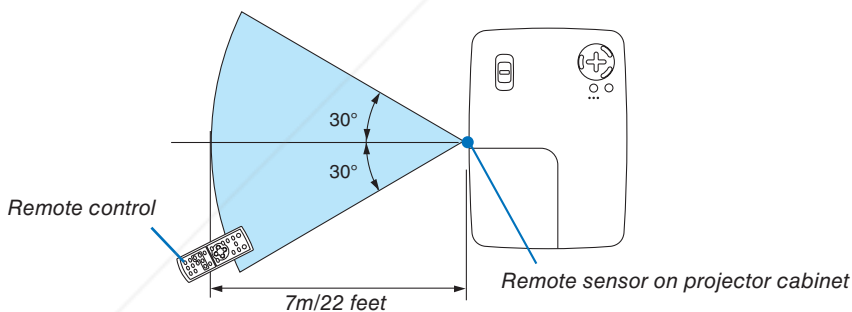

- The infrared signal operates by line-of-sight up to a distance of about 22 feet/7 m and within a 60-degree angle of the remote sensor on the projector cabinet.
- The projector will not respond if there are objects between the remote control and the sensor, or if strong light falls on the sensor. Weak batteries will also prevent the remote control from properly operating the projector.

Discount-Merchant.com (800) 281-8860  
 THE TRUSTED SOURCE FOR PROJECTOR LAMPS AND ACCESSORIES

# 2. Installation and Connections

This section describes how to set up your projector and how to connect video and audio sources.

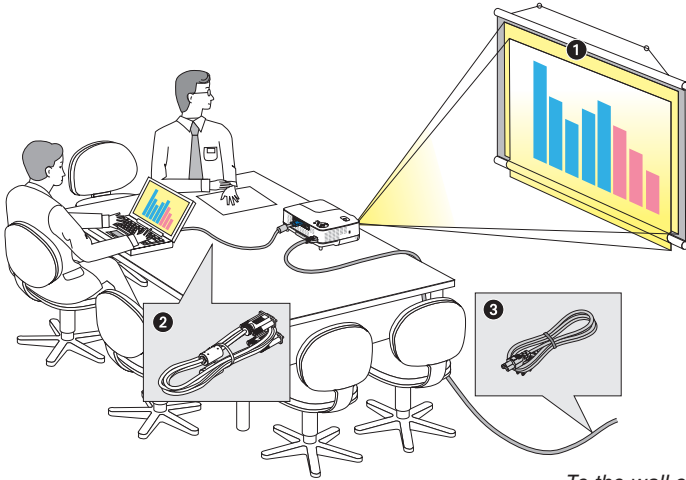

Your projector is simple to set up and use. But before you get started, you must first:

- ❶ Set up a screen and the projector.
- ❷ Connect your computer or video equipment to the projector. See pages 12 to 14.
- ❸ Connect the supplied power cable. See page 15.

*NOTE: Ensure that the power cable and any other cables are disconnected before moving the projector. When moving the projector or when it is not in use, cover the lens with the lens cap.*



To the wall outlet.

## ❶ Setting Up the Screen and the Projector

### Selecting a Location

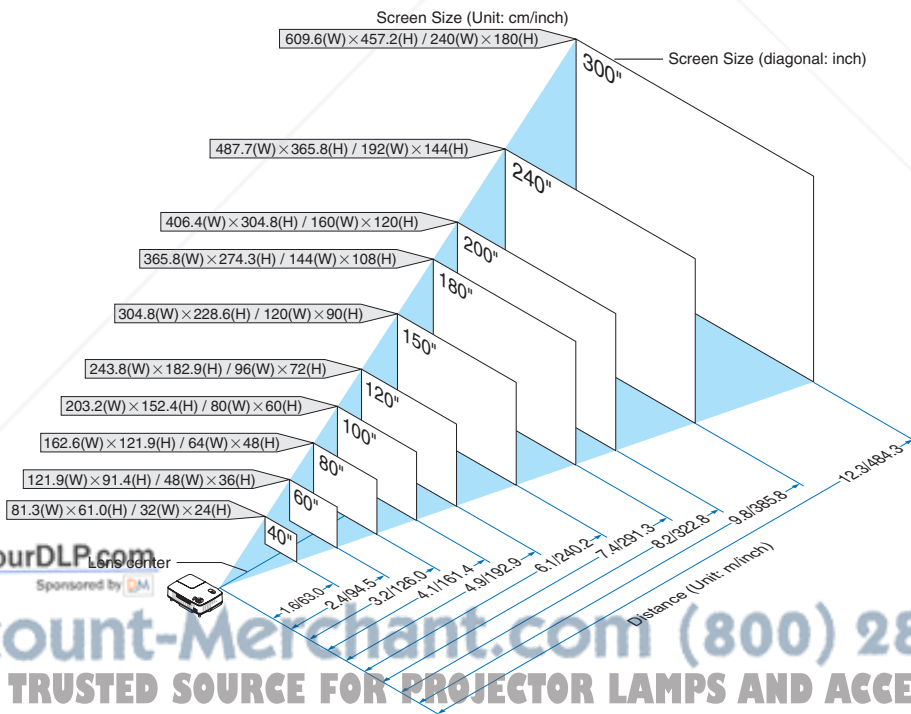
The further your projector is from the screen or wall, the larger the image. The minimum size the image can be is approximately 40" (1.0 m) measured diagonally when the projector is roughly 63 inches (1.6 m) from the wall or screen. The largest the image can be is 300" (7.6 m) when the projector is about 484 inches (12.3 m) from the wall or screen. Use the chart below as a rough guide.



**FixYourDLP.com**  
 Sponsored by 

Discount-Merchant.com (800) 281-8860

THE TRUSTED SOURCE FOR PROJECTOR LAMPS AND ACCESSORIES

**NOTE:**

- The distances are indicated by intermediate values between tele and wide. Use as a rule of thumb.
- The Zoom lever adjusts the image size up to +/-10%
- For more details on throw distance, see next page.
- Changing the image size starts the Auto Focus to adjust the focus; changing the throw angle starts the Auto Keystone to correct the vertical keystone distortion.

**Throw Distance and Screen Size**

The following shows the proper relative positions of the projector and screen. Refer to the table to determine the position of installation.

**Distance Chart**

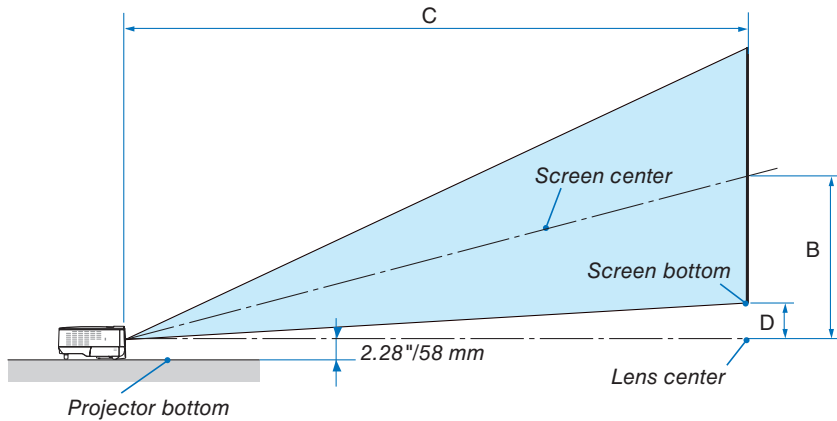

Screen Size			B	C		D	α	
Diagonal	Width	Height		wide	- tele		wide	- tele
inch	inch	inch	inch	inch	inch	inch	degree	
33	26	20	13	-	57	3	- 12.6	
40	32	24	15	57	- 69	3	15.0 - 12.5	
60	48	36	23	87	- 104	5	14.9 - 12.4	
67	54	40	26	97	- 117	6	14.9 - 12.4	
72	58	43	28	104	- 126	6	14.9 - 12.4	
80	64	48	31	116	- 140	7	14.8 - 12.4	
84	67	50	32	122	- 147	7	14.8 - 12.4	
90	72	54	35	131	- 158	8	14.8 - 12.4	
100	80	60	38	145	- 175	8	14.8 - 12.3	
120	96	72	46	174	- 210	10	14.8 - 12.3	
150	120	90	58	219	- 263	13	14.7 - 12.3	
180	144	108	69	263	- 317	15	14.7 - 12.3	
200	160	120	77	292	- 352	17	14.7 - 12.3	
220	176	132	84	321	- 387	18	14.7 - 12.3	
240	192	144	92	351	- 422	20	14.7 - 12.3	
260	208	156	100	380	- 458	22	14.7 - 12.3	
280	224	168	107	409	- 493	23	14.7 - 12.3	
300	240	180	115	439	- 529	25	14.7 - 12.3	

Screen Size				B	C		D	α	
Diagonal	Width	Height	wide		- tele	wide		- tele	
inch	mm	mm	mm	mm	mm	mm	mm	degree	
33	838	671	503	321	-	1450	70	- 12.6	
40	1016	813	610	390	1450	- 1750	85	15.0 - 12.5	
60	1524	1219	914	584	2200	- 2650	127	14.9 - 12.4	
67	1702	1361	1021	653	2460	- 2960	142	14.9 - 12.4	
72	1829	1463	1097	701	2640	- 3190	153	14.9 - 12.4	
80	2032	1626	1219	779	2940	- 3550	170	14.8 - 12.4	
84	2134	1707	1280	818	3090	- 3730	178	14.8 - 12.4	
90	2286	1829	1372	877	3320	- 4000	191	14.8 - 12.4	
100	2540	2032	1524	974	3690	- 4450	212	14.8 - 12.3	
120	3048	2438	1829	1169	4430	- 5340	254	14.8 - 12.3	
150	3810	3048	2286	1461	5550	- 6690	318	14.7 - 12.3	
180	4572	3658	2743	1753	6670	- 8040	381	14.7 - 12.3	
200	5080	4064	3048	1948	7420	- 8940	424	14.7 - 12.3	
220	5588	4470	3353	2143	8160	- 9830	466	14.7 - 12.3	
240	6096	4877	3658	2337	8910	- 10730	509	14.7 - 12.3	
260	6604	5283	3962	2532	9650	- 11630	551	14.7 - 12.3	
280	7112	5690	4267	2727	10400	- 12530	593	14.7 - 12.3	
300	7620	6096	4572	2922	11140	- 13430	636	14.7 - 12.3	

B=Vertical distance between lens center and screen center

C=Throw distance

D=Vertical distance between lens center and bottom of screen(top of screen for ceiling application)

α=Throw angle

*NOTE: Distances may vary +/-5%.*



**Discount-Merchant.com (800) 281-8860**  
**THE TRUSTED SOURCE FOR PROJECTOR LAMPS AND ACCESSORIES**

### **WARNING**

- \* Installing your projector on the ceiling must be done by a qualified technician. Contact your NEC dealer for more information.
- \* Do not attempt to install the projector yourself.
- Only use your projector on a solid, level surface. If the projector falls to the ground, you can be injured and the projector severely damaged.
- Do not use the projector where temperatures vary greatly. The projector must be used at temperatures between 41°F (5°C) and 104°F (40°C). (Eco mode selected automatically at 95°F to 104°F/35°C to 40°C)
- Do not expose the projector to moisture, dust, or smoke. This will harm the screen image.
- Ensure that you have adequate ventilation around your projector so heat can dissipate. Do not cover the vents on the side or the front of the projector.

### **Reflecting the Image**

Using a mirror to reflect your projector's image enables you to enjoy a much larger image when a smaller space is required. Contact your NEC dealer if you need a mirror system. If you're using a mirror system and your image is inverted, use the MENU and SELECT buttons on your projector cabinet or your remote control to correct the orientation. (→ page 42)



**Discount-Merchant.com (800) 281-8860**  
**THE TRUSTED SOURCE FOR PROJECTOR LAMPS AND ACCESSORIES**

## ② Making Connections

### Connecting Your PC or Macintosh Computer

*NOTE: When using with a notebook PC, be sure to connect the projector and notebook PC while the projector is in standby mode and before turning on the power to the notebook PC.*

*In most cases the output signal from the notebook PC is not turned on unless connected to the projector before being powered up.*

*\* If the screen goes blank while using your remote control, it may be the result of the computer's screen-saver or power management software.*

#### Enabling the computer's external display

Displaying an image on the notebook PC's screen does not necessarily mean it outputs a signal to the projector. When using a PC compatible laptop, a combination of function keys will enable/disable the external display. Usually, the combination of the 'Fn' key along with one of the 12 function keys gets the external display to come on or off. For example, NEC laptops use Fn + F3, while Dell laptops use Fn + F8 key combinations to toggle through external display selections.

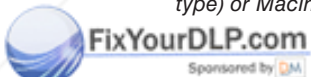
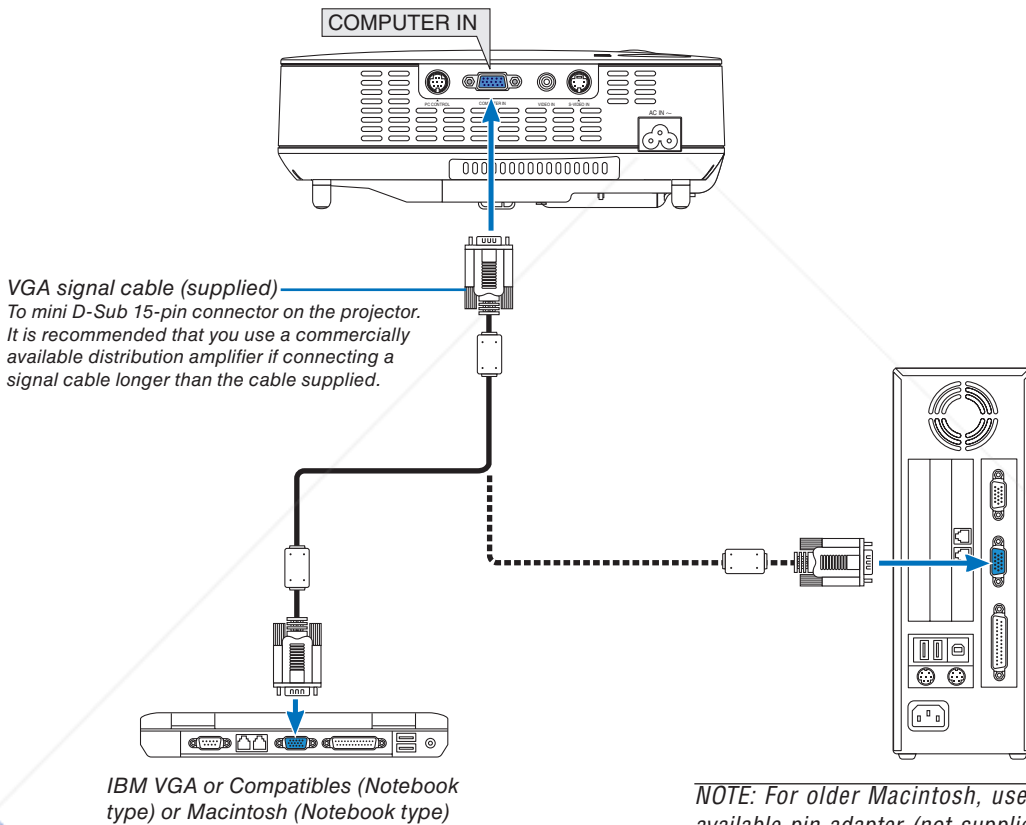

*NOTE: An image may not be displayed correctly when a Video or S-Video source is played back via a commercially available scan converter.*

*This is because the projector will process a video signal as a computer signal at the default setting. In that case, do the following.*

- When an image is displayed with the lower and upper black portion of the screen or a dark image is not displayed correctly: Project an image to fill the screen and then press the AUTO ADJ button on the remote control or the projector cabinet.
- The COMPUTER IN connector supports Plug & Play (DDC2B).

**Connecting Your DVD Player with Component Output**

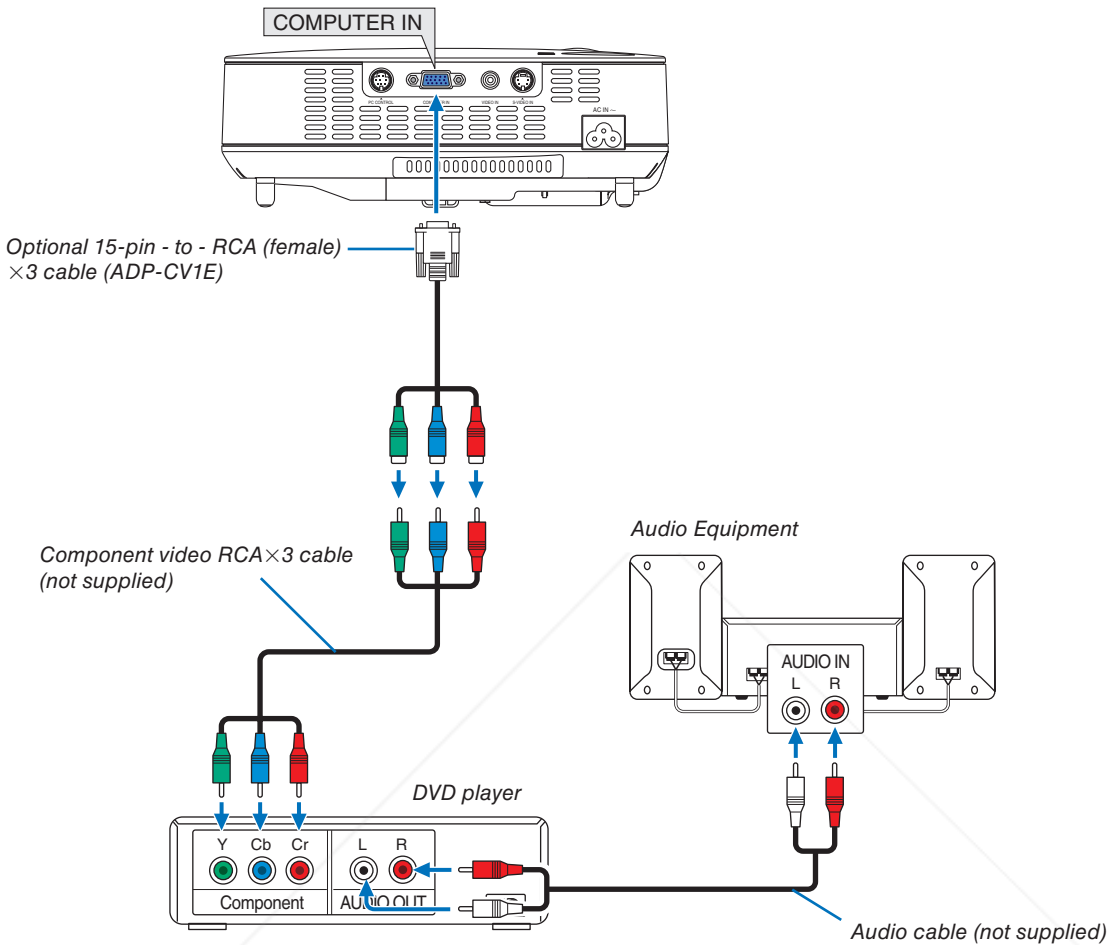

*NOTE: Refer to your DVD player's owner's manual for more information about your DVD player's video output requirements.*



**Discount-Merchant.com (800) 281-8860**  
**THE TRUSTED SOURCE FOR PROJECTOR LAMPS AND ACCESSORIES**

Connecting Your VCR or Laser Disc Player

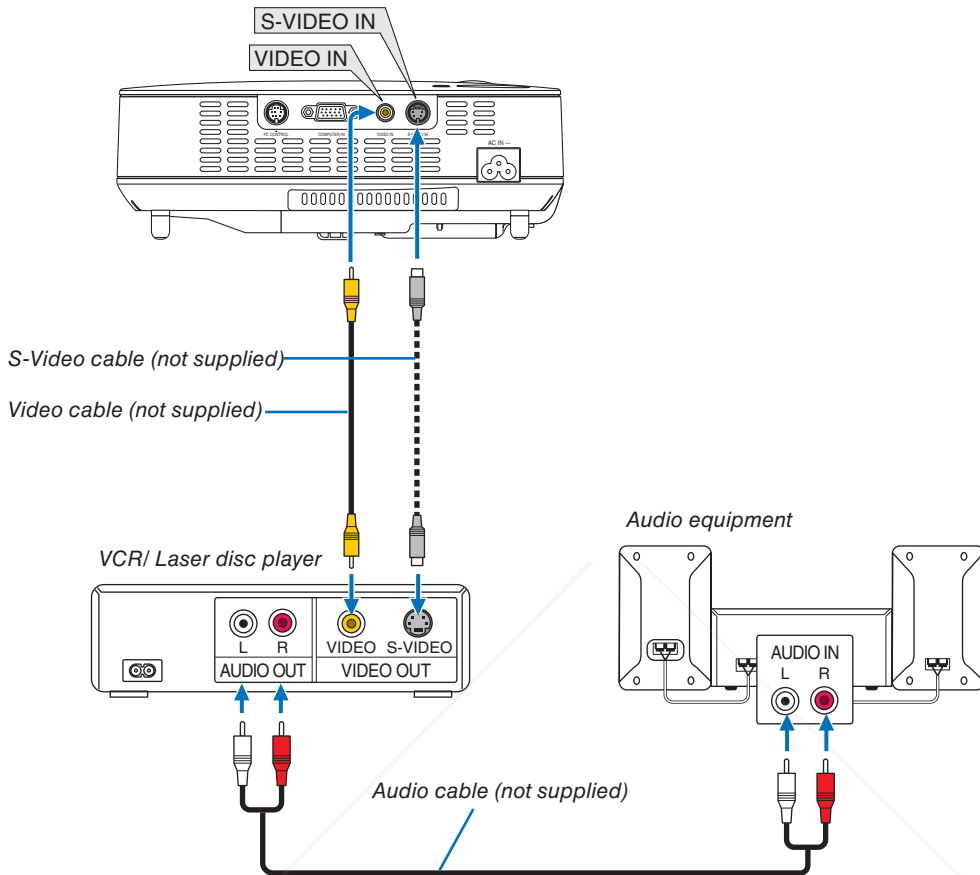

*NOTE: Refer to your VCR or laser disc player owner's manual for more information about your equipment's video output requirements.*

*NOTE: An image may not be displayed correctly when a Video or S-Video source is played back in fast-forward or fast-rewind via a scan converter.*



**Discount-Merchant.com (800) 281-8860**  
**THE TRUSTED SOURCE FOR PROJECTOR LAMPS AND ACCESSORIES**

### Connecting the Supplied Power Cable

Connect the supplied power cable to the projector.

First connect the supplied power cable's three-pin plug to the AC IN of the projector, and then connect the other plug of the supplied power cable in the wall outlet.

The projector will go into its stand-by mode and the power indicator will glow orange.

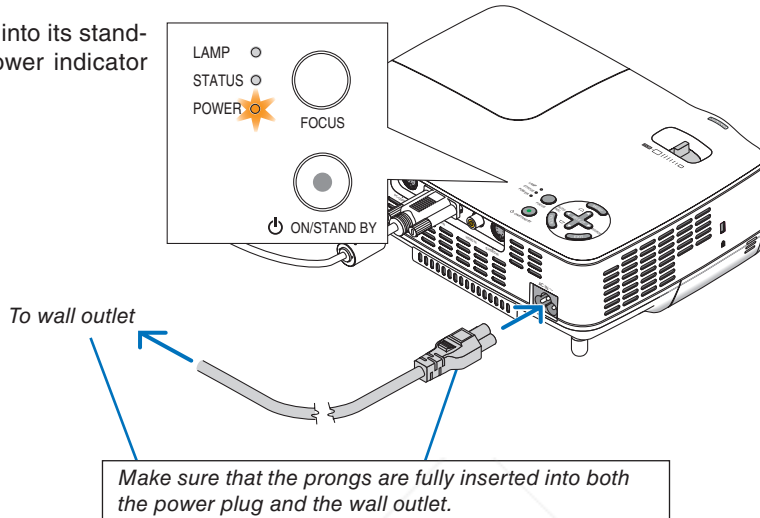

#### **CAUTION:**

Do not try to touch the ventilation outlet on the right front (when seen from the front) as it can become heated while the projector is turned on and immediately after the projector is turned off.



# 3. Projecting an Image (Basic Operation)

This section describes how to turn on the projector and to project a picture onto the screen.

## 1 Turning on the Projector

**NOTE:** Before turning on the projector, first connect the supplied power cable's three-pin plug to the AC IN of the projector, and then connect the other plug of the supplied power cable in the wall outlet. Make sure that the projector is in its standby mode and the power indicator is glowing orange.

### 1. Remove the lens cap.

#### **CAUTION:**

Do not remove the lens cap by pulling on the string. Doing so can cause mechanical damage to the part around the lens.

### 2. Press the **POWER (ON/STAND BY)** button on the projector cabinet or the **POWER ON** button on the remote control for 1 second.

The **POWER** indicator will turn to green and the projector will become ready to use.

#### **TIP:**

- \* Turning on the projector will instantly cause the Auto Focus function to operate. (→ page 22)
- \* When the key lock symbol (  ) is displayed at the bottom right of the menu, it means that the Control Panel Lock is turned on. (→ page 42)

After you turn on your projector, ensure that the computer or video source is turned on and that your lens cap is removed.

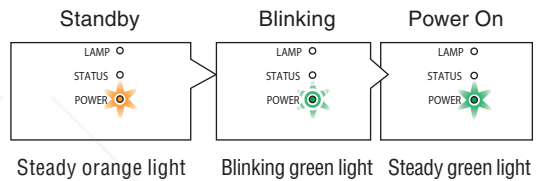
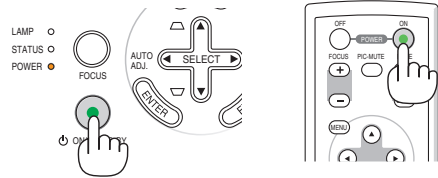

See page 52 for more details.

**NOTE:** When no signal is available, a blue or black screen is displayed.

When the projector displays a blue or black screen, the projector will automatically switch to the Eco mode.

The projector will return to the Normal mode once a signal is connected.

**NOTE:** If you turn on the projector immediately after the lamp is turned off or when the temperature is high, the fans run without displaying an image for some time and then the projector will display the image.



The projector cannot be turned off while the POWER indicator is blinking green.

- Do not turn off the AC power during this period. Doing so could cause premature lamp failure.

Merchant.com (800) 281-8860  
THE TRUSTED SOURCE FOR PROJECTOR LAMPS AND ACCESSORIES

### 3. Projecting an Image (Basic Operation)

#### Note on Startup screen (Menu Language Select screen)

When you first turn on the projector, you will get the Startup menu. The menu gives you the opportunity to select the menu in one of the nine languages.

To select a menu language, follow these steps:

1. Use the **SELECT** ▲ or ▼ button to select one of the nine languages from the menu.

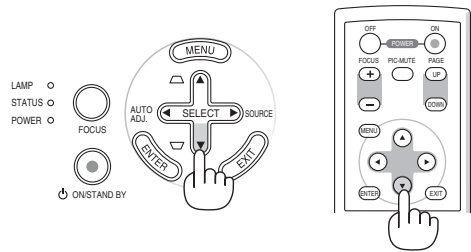
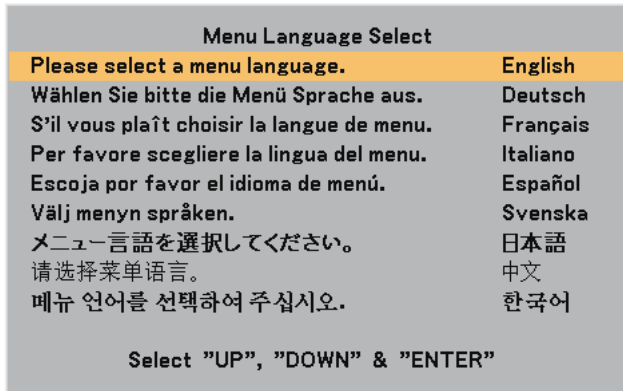

2. Press the **ENTER** button to execute the selection.

After this has been done, you can proceed to the menu operation.

If you want, you can select the menu language later. (→ [Language] on page 41)

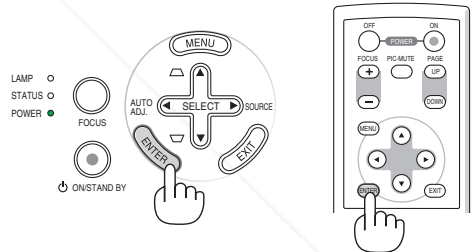

**NOTE:** Immediately after turning on the projector, screen flicker may occur. This is normal. Wait 3 to 5 minutes until the lamp lighting is stabilized.

When the [Lamp mode] is set to [Eco], the LAMP indicator will light green.

If one of the following things happens, the projector will not turn on.

- If the internal temperature of the projector is too high, the projector detects abnormal high temperature. In this condition the projector will not turn on to protect the internal system. If this happens, wait for the projector's internal components to cool down.

When the lamp reaches its end of usable life, the projector will not turn on. If this happens, replace the lamp.

If the lamp fails to light, and if the STATUS indicator flashes on and off in a cycle of six times, wait a full minute and then turn on the power.

FixYourDLP.com  
Discount-Merchant.com (800) 281-8860  
THE TRUSTED SOURCE FOR PROJECTOR LAMPS AND ACCESSORIES

## 2 Selecting a Source

### Selecting the computer or video source

*NOTE: Turn on the computer or video source equipment connected to the projector.*

#### Adjusting with buttons on the cabinet

**1. Press the SELECT ► button with no menus displayed.**

The Source list will be displayed.

- When the menu is displayed, press the EXIT button to close the menu and start the operation.

**2. Press the SELECT ► button a few times quickly to select a signal you want to display.**

Each time the SELECT ► button is pressed, each source name will be highlighted in sequence.

- The selected signal will be displayed.

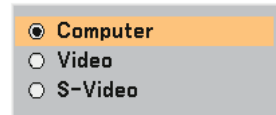
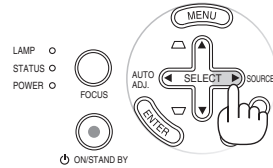

**TIP: Detecting the Signal Automatically**

Press and hold the SELECT ► button for a minimum of 2 seconds, the projector will search for the next available input source.

#### Detecting the Signal Automatically

Press and hold the SELECT ► button for a minimum of 2 seconds, the projector will search for the next available input source.

#### Using the Remote Control

Press any one of the VIDEO, S-VIDEO and COMPUTER buttons.

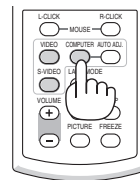

#### Selecting Default Source

You can set a source as the default source so that the default source will be displayed each time the projector is turned on.

1. Select [Setup - Options] → [Default Source Select] from the menu.

The [Default Source Select] screen will be displayed.

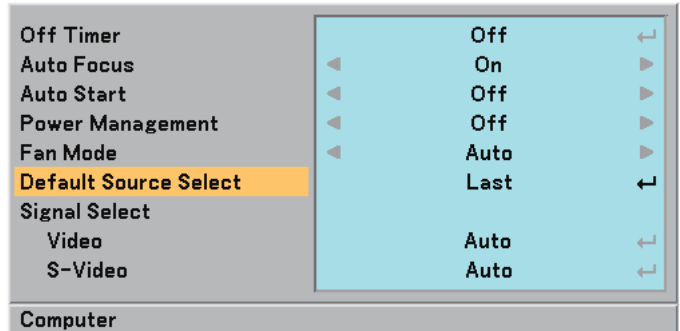

2. Select a source as the default source, and press the ENTER button.

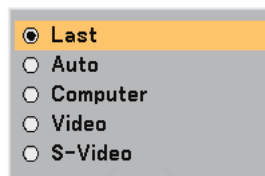

3. Press the EXIT button a few times to close the menu.

4. Restart the projector.

The source you selected in step 2 will be displayed.

(→ page 44)

### 3 Adjusting the Picture Size and Position

Place your projector on a flat level surface and ensure that the projector is square to the screen.

Lift the front edge of the projector to center the image vertically.

\* If the projected image does not appear square to the screen then use the Keystone feature for proper adjustment. (→ page 25)

#### About Auto Focus

Just placing the projector on a flat level surface makes a focused image. (→ page 22)

#### About Auto Keystone Correction

Adjusting the height of a projected image or changing the projection angle will result in the Auto Keystone function quickly correcting the vertical distortion. (→ page 23)

Move the projector left to center the image horizontally on the screen.

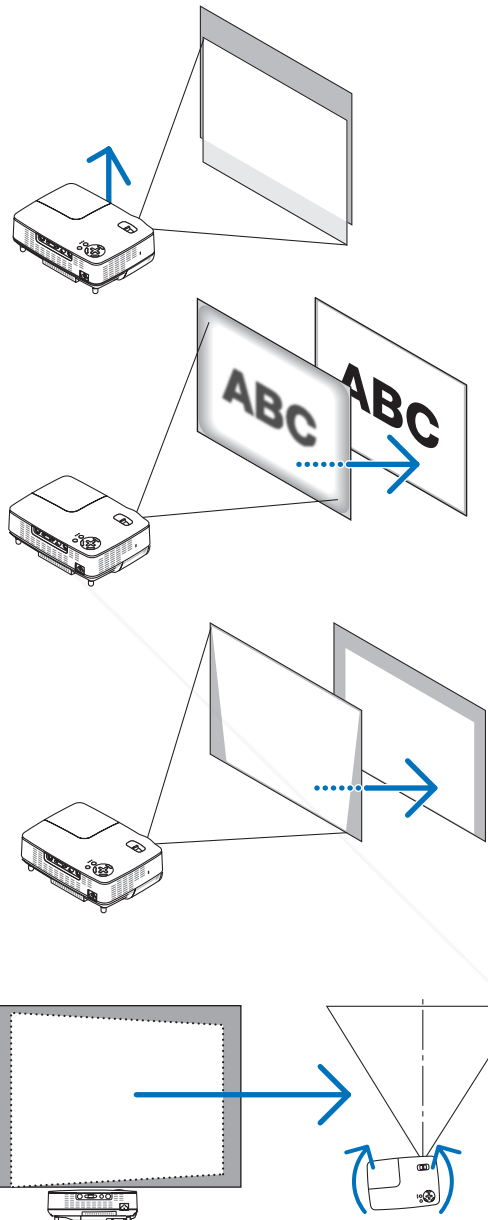

**Discount-Merchant.com (800) 281-8860**  
THE TRUSTED SOURCE FOR PROJECTOR LAMPS AND ACCESSORIES

### 3. Projecting an Image (Basic Operation)

#### Adjust the Tilt Foot

##### 1. Lift the front edge of the projector.

**⚠ CAUTION:**

Do not try to touch the ventilation outlet during Tilt Foot adjustment as it can become heated while the projector is turned on and during its cool down period after it is turned off.

##### 2. Push up and hold the Adjustable Tilt Foot Button on the front of the projector to extend the adjustable tilt foot (maximum height).

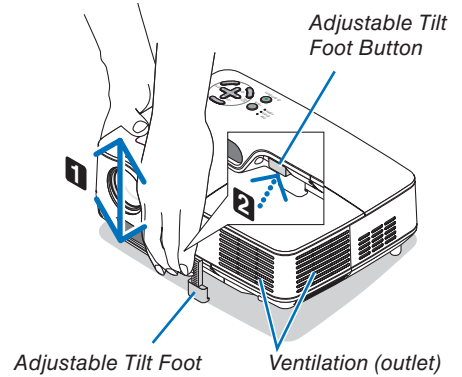

##### 3. Lower the front of the projector to the desired height.

##### 4. Release the Adjustable Tilt Foot Button to lock the adjustable tilt foot.

There is approximately 10 degrees (up) of adjustment for the front of the projector.

Adjusting the height of a projected image or changing the projection angle will result in the Auto Keystone function quickly correcting the vertical distortion.

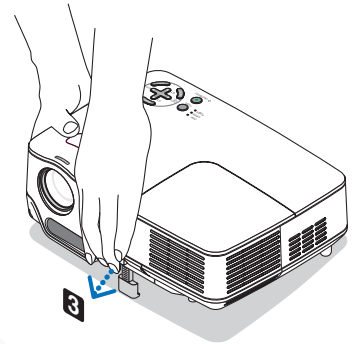

**⚠ CAUTION:**

Do not use the tilt-foot for purposes other than originally intended. Misuses such as using the tilt foot to carry or hang (from the wall or ceiling) the projector can cause damage to the projector.

**NOTE:** The rear foot height can be adjusted up to 0.16 inch/4 mm (1 degree of angle). Rotate the rear foot to the desired height in order to square the image on the projection surface. Do not extend the rear foot over 0.16" (4 mm). Doing so will cause the rear foot to come free off the bottom.

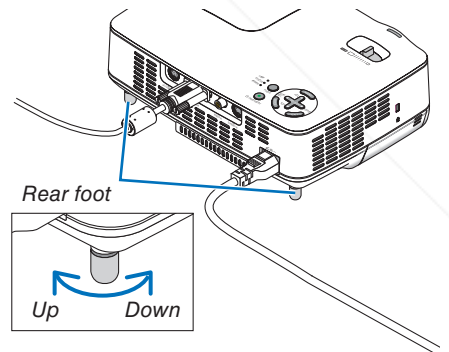
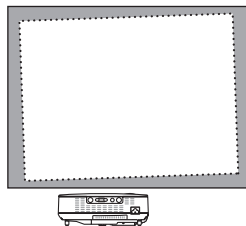

### 3. Projecting an Image (Basic Operation)

#### Zoom

Use the ZOOM lever to adjust the image size on the screen.

*NOTE: Rotating the ZOOM lever will cause the focus to be adjusted automatically.*

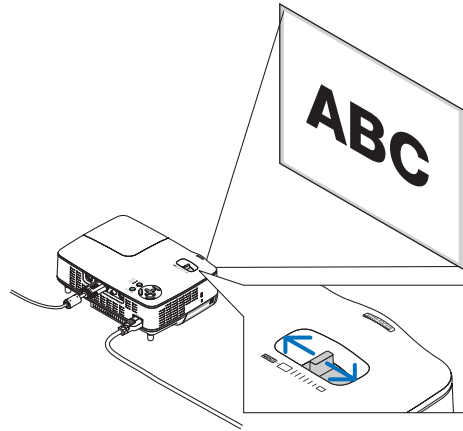

#### Auto Focus

The focus sensor on the projector detects the distance to the screen and automatically adjusts the focus of an image.

- The Auto Focus function will work when the following tasks are done:
  - Turning on the power
  - Changing the zoom lever
  - Repositioning the projector
  - Changing the projection angle

#### Effective auto focus range for screen 4:3

Throw distance		Image size (inch)	
		Tele (Zoom at min.)	Wide (Zoom at max.)
Minimum distance	57.1"/1.5 m	33"	40"
Maximum distance	216.5"/5.5 m	123"	149"

When the throw distance is beyond 5.5 m/216.5", it means that the focus sensor will not work correctly and that you need to use the FOCUS button to adjust the focus manually.

*NOTE: In some cases, the Auto Focus may not work correctly or the Auto Focus range can be made narrower, depending on the environmental conditions.*

*The Auto Focus function will not work under the following circumstances*

- When using a transparent screen.
- When there are objects between the focus sensor of the projector and the screen.
- When moving the projector so slowly that the focus sensor cannot detect the distance to the screen.
- When moving the screen, not the projector, because the focus sensor cannot detect the distance to the screen

**TIP:** To turn off the Auto Focus function, from the menu select [Setup - Options] → [Auto Focus] and select [Off].



**Discount-Merchant.com (800) 281-8860**  
**THE TRUSTED SOURCE FOR PROJECTOR LAMPS AND ACCESSORIES**

#### Auto Keystone Correction

The Auto Keystone correction feature will correct the vertical distortion of a projected image on the screen. No special operation required. Just place the projector on a flat surface.



---

*NOTE: When using the Auto Keystone function, heed the following:*

- The vertical keystone angle can be corrected between 16 degrees upward and 16 degrees downward from level.
- The Auto Keystone correction will take effect in 2 seconds after changing the projection angle during projection.
- The left and right, or horizontal keystone distortion is not available.

*Place the projector so that the lens surface is parallel to the screen.*

*Also, adjust the height to keep the projector level by rotating the rear feet.*

---

**TIP:** To turn off the Auto Keystone function, from the menu select [Setup - General] → [Auto Keystone] and select [Off]. (→ page 41) Even when the menu setting for [Auto Keystone] is turned on, [Keystone] can be adjusted manually.

---

*NOTE: Auto and Manual Keystone correction angle could be less than 16 degrees depending on some kinds of signal and aspect ratios.*

---

*NOTE: The Auto Keystone Correction feature can cause an image to be slightly blurred because the correction is made electronically.*

---



**Discount-Merchant.com (800) 281-8860**  
**THE TRUSTED SOURCE FOR PROJECTOR LAMPS AND ACCESSORIES**



#### 4 Adjusting Focus Manually

Adjust the focus manually in the following cases:

- When adjusting the focus out of the effective range of the automatic focus
- When finely adjusting the focus
- When the menu setting for [Auto Focus] is turned off

#### Adjusting with buttons on the cabinet

##### 1. Press the FOCUS button quickly.

The focus adjustment screen will be displayed.



The focus adjustment screen will be closed if no button operation is made for 5 seconds.

**TIP:** If the projector is placed within the effective focus range, pressing and holding the FOCUS for a minimum of 2 seconds starts the Auto Focus function.

##### 2. Press the SELECT ◀ or ▶ button to adjust the focus.

##### 3. Press the EXIT button.

The focus adjustment screen will be closed.

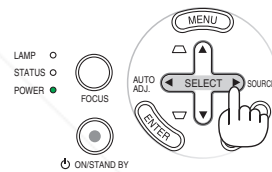
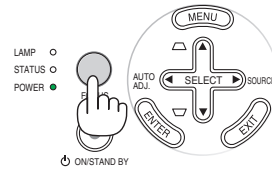

#### Adjusting with the remote control

##### 1. Press the FOCUS + or - button.

The focus adjustment screen will be displayed.



- The focus adjustment screen will be closed if no button operation is made for 5 seconds.
- Use the FOCUS + or - button to adjust the focus.

**TIP:** Pressing the AUTO ADJ button on the remote control causes the Auto Focus to work when the Focus adjustment screen is displayed if the projector is placed within the effective focus range.

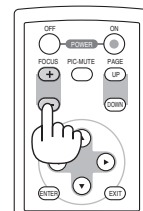

##### 2. Press the EXIT button.

The focus adjustment screen will be closed.

## 5 Correcting Keystone Distortion Manually

You can also correct the vertical keystone distortion manually.

*NOTE: Manual keystone correction is not available when there is no signal received by any input.*

Adjust the keystone distortion manually in the following cases:

- To fine tune Keystone correction even after performing the [Auto Keystone] adjustment
- When the menu setting for [Auto Keystone] is turned off

### Adjusting with buttons on the cabinet

1. Press the **SELECT ▲ or ▼** button with no menus displayed.

The slide bar will be displayed for your adjustment.

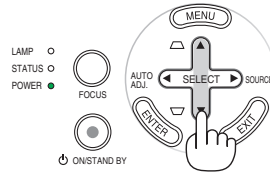

2. Press the **EXIT** button.

The slide bar will be closed.

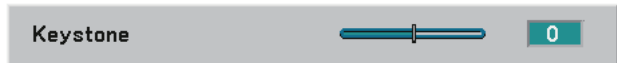

### Adjusting with the remote control

1. Press the **MENU** button.

The menu will be displayed.

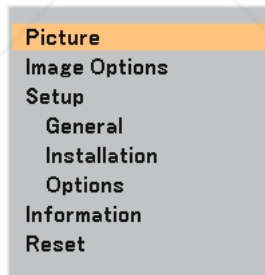

2. Use the **SELECT ▼** button to select [Setup - General] and then press the **ENTER** button.

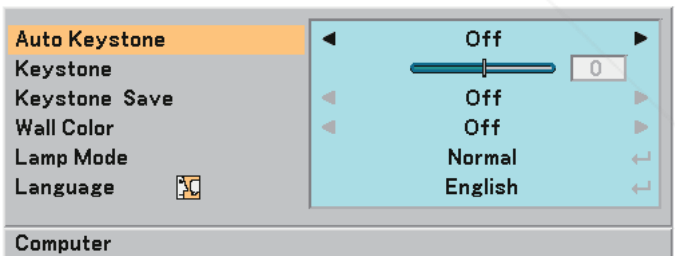

Select the **Keystone** function.

Use the **SELECT ▼** button to select [Keystone].

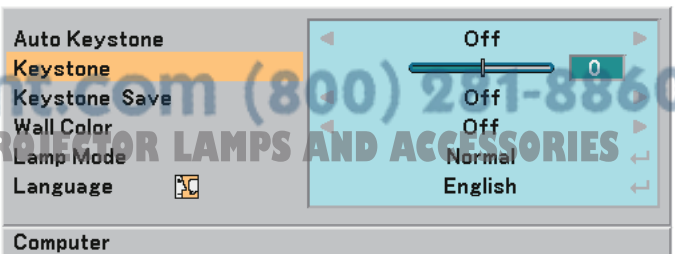

FLY-You-DI-Beam  
 Discount-Merch.com (800) 281-8860  
 THE TRUSTED SOURCE FOR PROJECTOR LAMPS AND ACCESSORIES

### 3. Projecting an Image (Basic Operation)

#### 4. Correct the vertical distortion.

Use the **SELECT** ◀ or ▶ button to correct the vertical keystone distortion.

*NOTE: The Keystone Correction feature can cause an image to be slightly blurred because the correction is made electronically.*

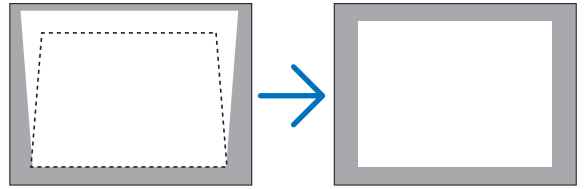

#### 5. Press the **EXIT** button twice to close the menu.

*TIP: You can save the changes using the Keystone Save feature when you turn off the projector. (→ page 41)*

## 6 Optimizing RGB Picture Automatically

### Adjusting the Image Using Auto Adjust

This adjustment may be necessary when you connect your computer for the first time.

#### Adjusting with buttons on the cabinet

- Press the **SELECT** ◀ button with no menus displayed. An RGB image will be optimized automatically after a few seconds.

#### Adjusting with the remote control

- Press the **AUTO ADJ.** button to optimize an RGB image automatically.

[Poor picture]

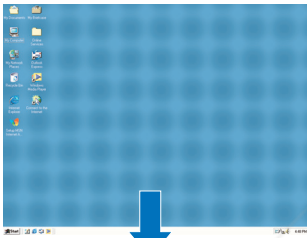

[Normal picture]

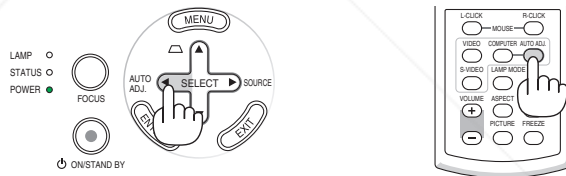
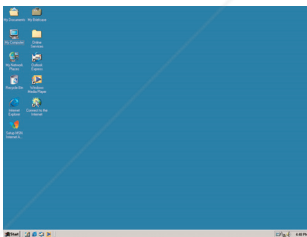

*NOTE: The signals may take time to display or may not be displayed correctly.*

*The Auto Adjust function does not work for component and video signals.*

- If the Auto Adjust operation cannot optimize the RGB signal, try to adjust Horizontal/Vertical Position, Clock and Phase manually. (→ page 40)
- If performing the Auto Adjust function does not correct image positioning, vertical stripes (banding) or horizontal noise, perform the [Horizontal], [Vertical], [Clock] or [Phase] function from the menu to optimize the image. (→ page 40)
- Performing the [Horizontal], [Vertical], [Clock] or [Phase] function will store the adjustment values of the currently projected source into the projector's memory.
- The next time the same source (same resolution, horizontal and vertical frequencies) is projected; the projector will call up from memory the stored values for the source.
- To clear the stored adjustment values, select the [Reset] → [Current Signal] or [All Data] from the menu to reset the adjustment values.

## 7 Turning off the Projector

To turn off the projector:

First, press the POWER (ON/STAND BY) button on the projector cabinet or the POWER OFF button on the remote control. The "Power Off / Are you sure?" message will appear.

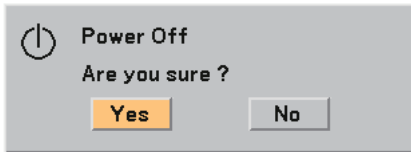

Secondly, press the ENTER button or press the POWER (ON/STAND BY) or the POWER OFF button again. The power indicator will glow orange. Immediately after turning on the projector and displaying an image, you cannot turn off the projector for 60 seconds.

### About Direct Power Off

The projector has a feature called "Direct Power Off". This feature allows you to unplug the projector when projecting an image.

*NOTE: Do not turn off the projector using the "Direct Power Off" function within 10 seconds of making adjustment or setting changes and closing the menu. Doing so can cause loss of adjustments and settings.*

### ⚠ CAUTION:

Parts of the projector will become heated during operation. Use caution when picking up the projector immediately after it has been operating.

## 8 After Use

Preparation: Make sure that the projector is turned off.

1. Unplug the power cable.
2. Disconnect any other cables.
3. Retract adjustable tilt foot and rear foot if extended.
4. Cover the lens with the lens cap.
5. Put the projector and its accessories in the supplied soft case.

### ⚠ CAUTION:

Use caution when putting the projector in the soft case immediately after the projector has been operating. The projector cabinet is hot.

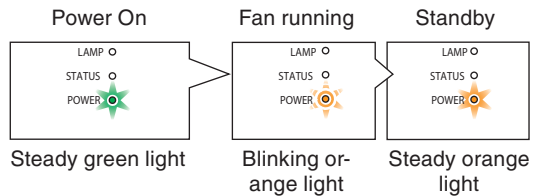
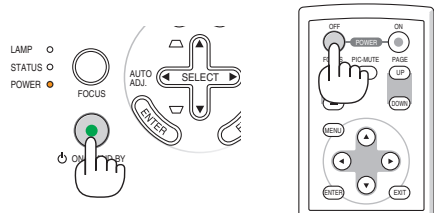

Discount-Merchant.com (800) 281-8860  
THE TRUSTED SOURCE FOR PROJECTOR LAMPS AND ACCESSORIES

# 4. Convenient Features

## 1 Turning off the Image

Press the PIC-MUTE button to turn off the image for a short period of time. Press again to restore the image.

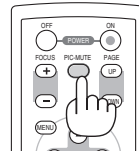

## 2 Freezing a Picture

Press the FREEZE button to freeze a picture. Press again to resume motion.

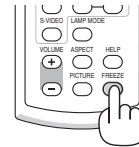

## 3 Changing Lamp Mode

The lamp life can be extended by using the Eco mode.

To change to the “Eco” mode, do the following:

1. Press the LAMP MODE button to display [Lamp Mode] screen.
2. Use the SELECT ▲ or ▼ button to select [Eco] mode.
3. Press the ENTER button. Or press the SELECT ► button to select [OK] and press the ENTER button.

To cancel it, select [Cancel] and press the ENTER button.

To change from [Eco] to [Normal], Go back to Step 2 and select [Normal]. Repeat Step 3.

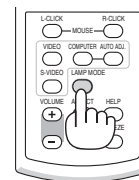

Lamp Mode	Description	Status of LAMP indicator
Normal Mode	This is the default setting (100% Brightness).	Off
Eco Mode	Select this mode to increase the lamp life (NP60: approx. 80% Brightness, NP50/NP40: approx. 90% Brightness).	Steady Green light

(→ page 41)

## 4 Preventing the Unauthorized Use of the Projector

A keyword can be set for your projector using the Menu to avoid operation by an unauthorized user. When a keyword is set, turning on the projector will display the Keyword input screen. Unless the correct keyword is entered, the projector cannot project an image.

To enable the Security function:

1. Press the MENU button.  
The menu will be displayed.
2. Use SELECT ▲ or ▼ button to select [Setup - Installation] → [Security] and press the ENTER button.

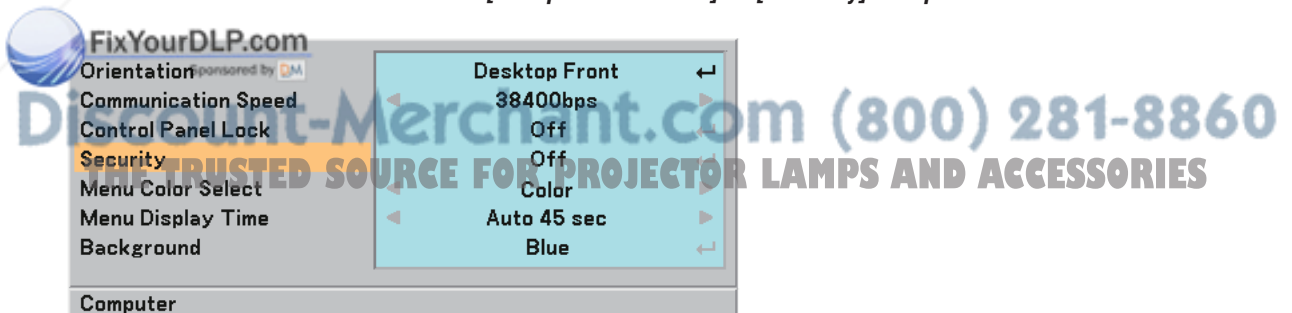

The Off/On menu will be displayed.

3. Select [On] and press the ENTER button.



The [Security Keyword] screen will be displayed.

4. Type in a combination of the four SELECT ▲▼◀▶ buttons and press the ENTER button.

*NOTE: A keyword must be 4 to 10 digits in length.*



The [Confirm Keyword] screen will be displayed.

5. Type in the same combination of SELECT ▲▼◀▶ buttons and press the ENTER button.

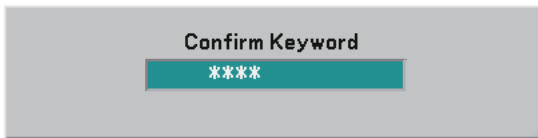

The confirmation screen will be displayed.

6. Select [Yes] and press the ENTER button.

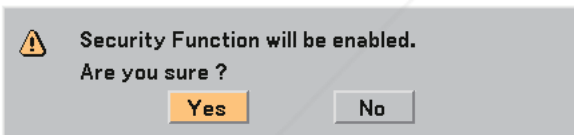

The Security function has been enabled.

To turn on the projector when [Security] is enabled:

When the Security function is enabled and the projector is turned on, the projector will display a blue background.

To display an image at this time, press the MENU button to display the Keyword input screen.

Type in the correct keyword and press the ENTER button. The projector will display an image.

*NOTE: The security disable mode is maintained until the main power is turned off or unplugging the power cable.*

To disable the Security function:

**1. Press the MENU button.**

The menu will be displayed.

**2. Select [Setup - Installation] → [Security] and press the ENTER button.**

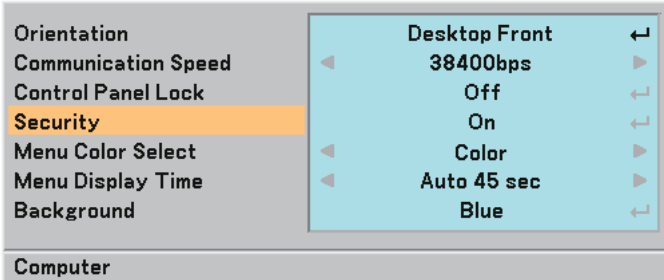

The Off/On menu will be displayed.

**3. Select [Off] and press the ENTER button.**



The Keyword confirmation screen will be displayed.

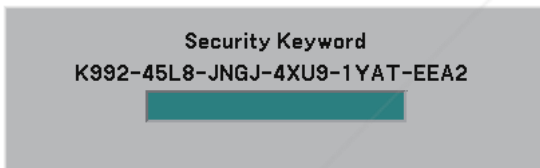

**4. Type in your keyword and press the ENTER button.**

When the correct keyword is entered, the Security function will be disabled.

*NOTE: If you forget your keyword, contact your dealer. Your dealer will provide you with your keyword in exchange for your request code. Your request code is displayed in the Keyword Confirmation screen. In this example [K992-45L8-JNGJ-4XU9-1YAT-EEA2] is a request code.*



**Discount-Merchant.com (800) 281-8860**  
**THE TRUSTED SOURCE FOR PROJECTOR LAMPS AND ACCESSORIES**

## 5 Using the Optional Remote Mouse Receiver (NP01MR)

The optional remote mouse receiver enables you to operate your computer's mouse functions from the remote control. It is a great convenience for clicking through your computer-generated presentations.

### Connecting the remote mouse receiver to your computer

If you wish to use the remote mouse function, connect the mouse receiver and computer. The mouse receiver can be connected directly to the computer's USB port (type A).

*NOTE: Depending on the type of connection or OS installed on your computer, you may have to restart your computer or change your computer settings.*

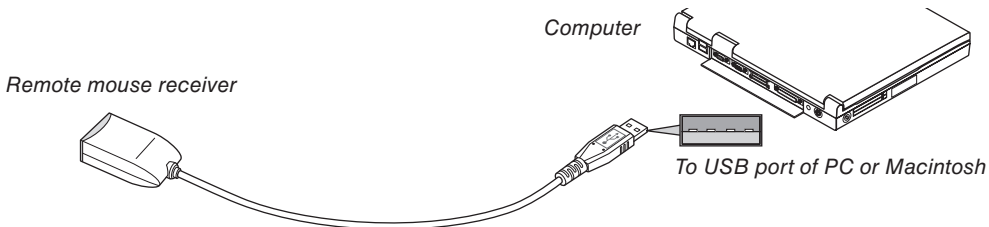

### When operating a computer via the remote mouse receiver

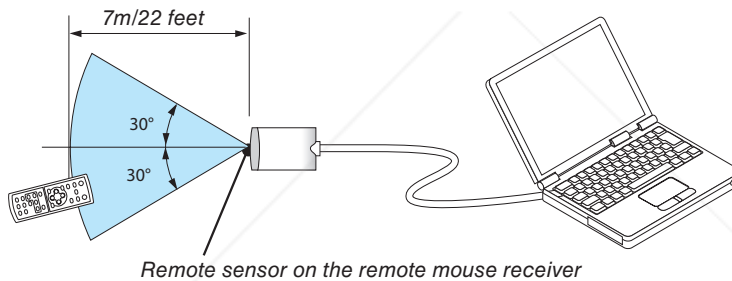

### When connecting using the USB terminal

For PC, the mouse receiver can only be used with a Windows 98/Me/XP\*, Windows 2000 or Mac OS X 10.0.0 or later operating system.

*\* NOTE: In Windows XP, if the mouse cursor will not move correctly, do the following: Clear the Enhance pointer precision check box underneath the mouse speed slider in the Mouse Properties dialog box [Pointer Options tab].*

*NOTE: Wait at least 5 seconds after disconnecting the mouse receiver before reconnecting it and vice versa. The computer may not identify the mouse receiver if it is repeatedly connected and disconnected in rapid intervals.*

### Operating your computer's mouse from the remote control

can operate your computer's mouse from the remote control.

PAGE UP/DOWN Button.....scrolls the viewing area of the window or to move to the previous or next slide in PowerPoint on your computer.

SELECT ▲▼◀▶ Buttons.... moves the mouse cursor on your computer.

MOUSE L-CLICK Button..... works as the mouse left button.

MOUSE R-CLICK Button..... works as the mouse right button.

*NOTE: When you operate the computer using the SELECT ▲▼◀ or ▶ button with the menu displayed, both the menu and the mouse pointer will be affected. Close the menu and perform the mouse operation.*



### About Drag Mode

By pressing the MOUSE L-CLICK or R-CLICK button for 2 or 3 seconds then releasing, the drag mode is set and the drag operation can be performed simply by pressing the SELECT ▼▲► button. To drop the item, press the MOUSE L-CLICK (or R-CLICK) button. To cancel it, press the MOUSE R-CLICK (or L-CLICK) button.

***TIP:** You can change the Pointer speed on the Mouse Properties dialog box on the Windows. For more information, see the user documentation or online help supplied with your computer.*



**Discount-Merchant.com (800) 281-8860**  
**THE TRUSTED SOURCE FOR PROJECTOR LAMPS AND ACCESSORIES**

# 5. Using On-Screen Menu

## 1 Using the Menus

*NOTE: The on-screen menu may not be displayed correctly while an interlaced motion video image is projected.*

1. Press the **MENU** button on the remote control or projector cabinet to display the main menu.

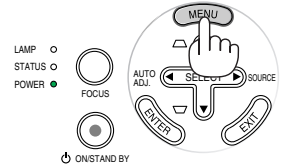
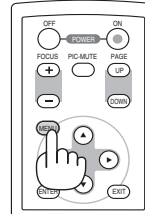
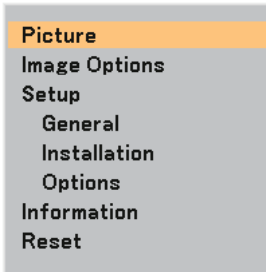

2. Press the **SELECT**  $\blacktriangle/\blacktriangledown$  buttons on the remote control or the projector cabinet to highlight the menu for the item you want to adjust or set.

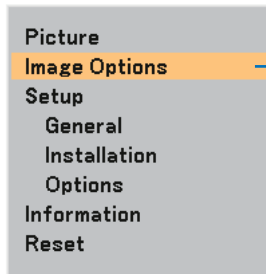

Highlight Indicates the selected menu or item.

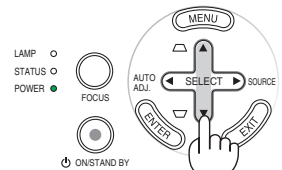
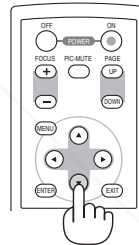

3. Press the **ENTER** button on the remote control or the projector cabinet to select a submenu or item.

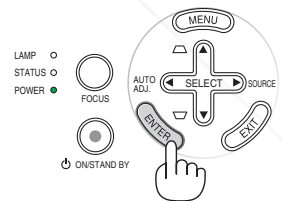
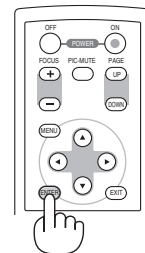
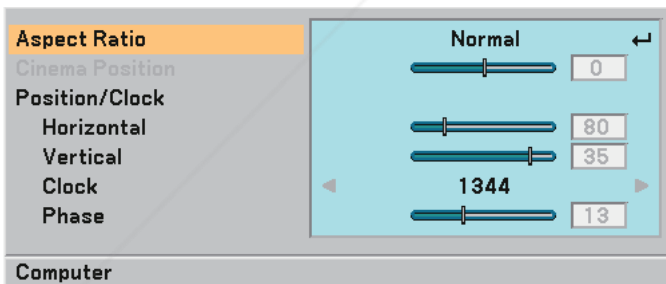

4. Use the **SELECT**  $\blacktriangle/\blacktriangledown$  buttons on the remote control or the projector cabinet to select the item you want to adjust or set.

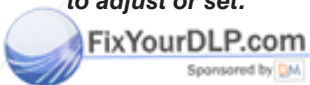

Discount-Merchant.com (800) 281-9860  
THE TRUSTED SOURCE FOR PROJECTOR LAMPS AND ACCESSORIES

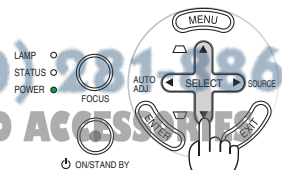

5. Adjusting the level of a selected item or selecting an item.

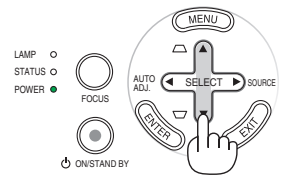
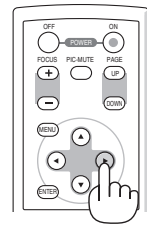
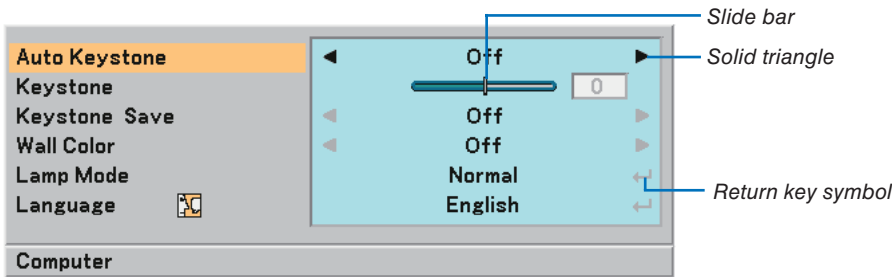

**For Adjusting items (Slide bar)**

Slide bar..... Indicates settings or the direction of adjustment.

- Use the SELECT ◀▶ buttons to adjust the item.

**For Selecting items (Solid triangle)**

Solid triangle..... Indicates further choices are available. A highlighted triangle indicates the item is active.

- Use the SELECT ◀▶ buttons to select the item.

**For Selecting items (Return key symbol, Radio button)**

Return key symbol..... Indicates further choices are available.

Radio button ..... Use this round button to select an option in a dialog box.

- 1) Press the ENTER button. The selected item will be displayed.
- 2) Use the SELECT ▲▼ buttons to highlight the item you want to set.

Changes are stored until you adjust it again.

Press the EXIT button to return to the previous screen.

6. Repeat steps 2-5 to adjust an additional item, or press the EXIT button several times to close the menu.



**Discount-Merchant.com (800) 281-8860**  
**THE TRUSTED SOURCE FOR PROJECTOR LAMPS AND ACCESSORIES**

## 2 Menu Elements

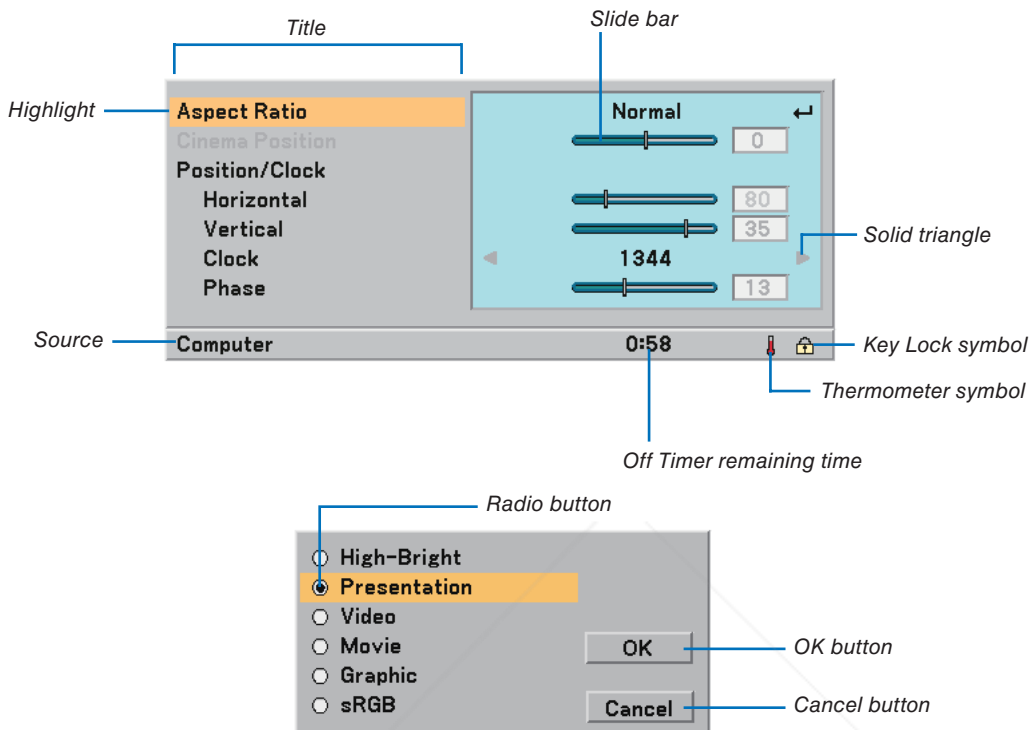

Menu windows or dialog boxes typically have the following elements:

- Title ..... Indicates the menu title.
- Highlight..... Indicates the selected menu or item.
- Source..... Indicates the currently selected source.
- Off timer remaining time..... Indicates the remaining countdown time when the Off Timer is preset.
- Solid triangle..... Indicates further choices are available. A highlighted triangle indicates the item is active.
- Radio button ..... Use this round button to select an option in a dialog box.
- Slide bar ..... Indicates settings or the direction of adjustment.
- OK button..... Press to confirm your setting. You will return to the previous menu.
- Cancel button..... Press to cancel your setting. You will return to the previous menu.
- Key Lock symbol..... Indicates the Control Panel Lock is enabled.
- Thermometer symbol..... Indicates the lamp mode is forcibly set to Eco mode because the internal temperature is too high.

 Discount-Merchant.com (800) 281-8860  
 THE TRUSTED SOURCE FOR PROJECTOR LAMPS AND ACCESSORIES

### 3 List of Menu Items

Some menu items are not available depending on the input source.

Picture	Default	Item	Resettable
Preset		1 to 6	
Detail Settings	Reference	* High-Bright, Presentation, Video, Movie, Graphic, sRGB	
	Gamma Correction	* Dynamic, Natural, Black Detail	Yes
	Color Temperature	* 5000, 6500, 7800, 8500, 9300, 10500	Yes
	White Peaking	*	Yes
Contrast			Yes
Brightness			Yes
Sharpness			Yes
Color			Yes
Hue			Yes
Reset			

Image Options	Default	Item	Resettable
Aspect Ratio	*	Normal, Cinema, Native	Yes
Cinema Position			Yes
Position/Clock	Horizontal		Yes
	Vertical		Yes
	Clock		Yes
	Phase		Yes
Noise Reduction	Off	Off, On	Yes
Teletext	Off	Off, Auto	Yes

Setup	Default	Item	Resettable	
General	Auto Keystone	On	Off, On	Yes
	Keystone			Yes
	Keystone Save	Off	Off, On	Yes
	Wall Color	Off	Off, Blackboard, Blackboard(Gray), Light yellow, Light green, Light blue, Sky blue, Light rose, Pink	Yes
	Lamp Mode	Normal	Normal, Eco	Yes
	Language	English	English, Deutsch, Français, Italiano, Español, Svenska, 日本語, Dansk, Português, Čeština, Magyar, Polski, Nederlands, Suomi, Norsk, Türkçe, Русский, Ελληνικά, 中文, 한국어	-
Installation	Orientation	Desktop Front	Desktop Front, Ceiling Rear, Desktop Rear, Ceiling Front	Yes
	Communication Speed	38400bps	4800bps/9600bps/19200bps/38400bps	-
	Control Panel Lock	Off	Off, On	Yes
	Security	Off	Off, On	-
	Menu Color Select	Color	Color, Monochrome	Yes
	Menu Display Time	Auto 45 sec	Manual/Auto 5 sec/Auto 15sec/Auto 45 sec	Yes
	Background	Blue	Blue, Black	-
	Off Timer	Off	Off/0:30/1:00/2:00/4:00/8:00/12:00/16:00	Yes
	Auto Focus	On	Off, On	Yes
	Auto Start	Off	Off, On	Yes
	Power Management	Off	Off/0:05/0:10/0:20/0:30	Yes
	Fan Mode	Auto	Auto, High	Yes
	Default Source Select	Last	Last, Auto, Computer, Video, S-Video	Yes
	Signal Select			
	Video	Auto	Auto, NTSC3.58, NTSC4.43, PAL, PAL-M, PAL-N, PAL60, SECAM	Yes
	S-Video	Auto	Auto, NTSC3.58, NTSC4.43, PAL, PAL-M, PAL-N, PAL60, SECAM	Yes

\* The asterisk (\*) indicates that the default setting varies depending on the signal.

## 5. Using On-Screen Menu

Information		Item
Usage Time	Lamp Life Remaining	
	Lamp Hours Used	
Source	Horizontal Frequency	
	Vertical Frequency	
	Video Type	NTSC, NTSC3.58, NTSC4.43, PAL, PAL-M, PAL-N, PAL60, SECAM
	Sync Type	Separate Sync, Composite Sync, Sync on Green, Sync on Video
	Sync Polarity	
Version	Scan Type	Interlace, Non-Interlace
	Product	
	Serial Number	
	Firmware	
	Data	

Reset		Item
Current Signal		
All Data		
Clear Lamp Hours		



**Discount-Merchant.com (800) 281-8860**  
**THE TRUSTED SOURCE FOR PROJECTOR LAMPS AND ACCESSORIES**

## 4 Menu Descriptions & Functions [Picture]

### Preset

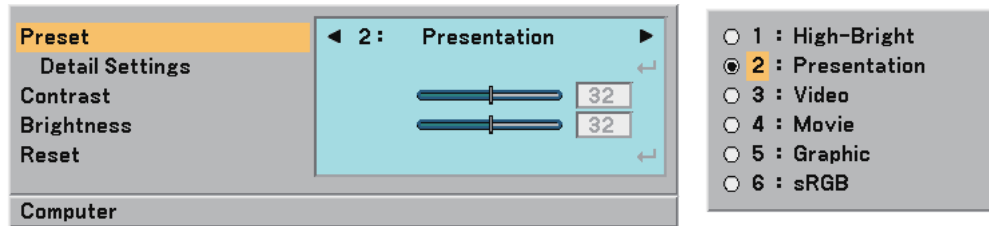

When selecting user adjustable presetting (Preset), the submenu will be displayed. You can customize each gamma or color. To do so, first select [Preset] and press the ENTER button, and then proceed with the following steps.

### Detail Settings

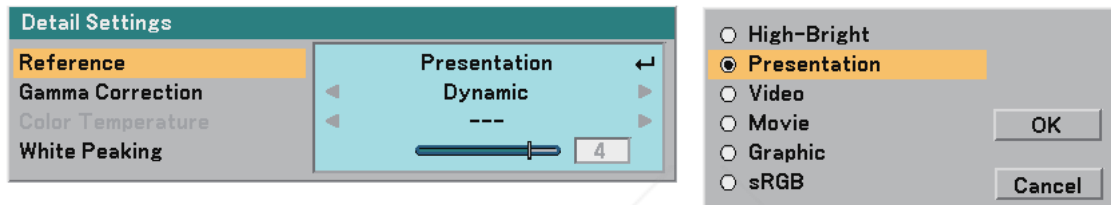

#### Selecting Reference Setting [Reference]

This option allows you to select one of five user adjustable presettings. There are 6 factory presets optimized for various types of images, you can set user adjustable settings.

- High-Bright ..... Recommended for the use in a brightly lit room.
- Presentation..... Recommended for making a presentation using a PowerPoint file.
- Video ..... Recommended for standard video such as a TV program.
- Movie ..... Recommended for film based video such as a movie (DVD or HDTV).
- Graphic..... Recommended for graphics.
- sRGB ..... Standard color values.

#### Selecting Gamma Correction Mode [Gamma Correction]

Each mode is recommended for:

- Dynamic ..... Creates a high-contrast picture.
- Natural ..... Natural reproduction of the picture.
- Black Detail ..... Emphasizes detail in dark areas of the picture.

#### Adjusting Color Temperature [Color Temperature]

This option allows you to adjust the color temperature.

Use the SELECT ◀ or ▶ button to increase color temperature (more blue); to decrease color temperature (more red): 5000, 6500, 7800, 8500, 9300, 10500K.

#### NOTE:

- When [High-Bright] or [Presentation] is selected in [Reference], [Color Temperature] is not available.
- When color options other than [Off] is selected in [Wall Color], [Color Temperature] is not available.
- The adjustable range may vary depending on White Peaking adjustment.

#### Adjusting White Peaking [White Peaking]

This allows you to adjust the drive level of the white areas. As the picture becomes dim, it looks more natural.

#### NOTE:

- When [High-Bright] is selected in [Reference], [White Peaking] is not available.
- When this option is highlighted, pressing the ENTER button will display its slide bar for adjustment.

### Adjusting Contrast, Brightness, Sharpness, Color and Hue

You can adjust contrast, brightness, sharpness, color and hue.

**TIP:** When one of Contrast, Brightness, Sharpness, Color or Hue is highlighted, pressing the ENTER button will display its slide bar for adjustment.

- Contrast ..... Adjusts the intensity of the image according to the incoming signal (White level of the image).
- Brightness..... Adjusts the brightness level or the black level of the image.
- Sharpness ..... Controls the detail of the image for Video (not valid for RGB).
- Color..... Increases or decreases the color saturation level (not valid for RGB).
- Hue..... Varies the color level from +/- green to +/-blue. The red level is used as reference. This adjustment is only valid for Video and Component inputs (not valid for RGB).

Input signal	Contrast	Brightness	Sharpness	Color	Hue
Computer (RGB)	Yes	Yes	No	No	No
Component	Yes	Yes	Yes	Yes*	Yes*
Video, S-Video	Yes	Yes	Yes	Yes	Yes

Yes=Adjustable, No=Not adjustable, Yes\* = depending on the signal

### Reset

The settings and adjustments for [Picture] will be returned to the factory settings with the exception of the following; Preset numbers and [Reference] within the [Preset] screen.

The settings and adjustments under [Detail Settings] within the [Preset] screen that are not currently selected will not be reset.

## 5 Menu Descriptions & Functions [Image Options]

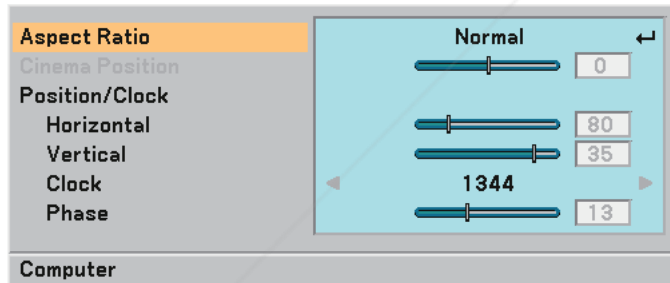

### Selecting Aspect Ratio [Aspect Ratio]

Aspect Ratio allows you to select the best Aspect mode to display your source image.

You can also display the Aspect Ratio window by pressing the ASPECT button on the remote control. (→ page 7)

When 4:3 is selected from the source (i.e. DVD player), the following selections will display:

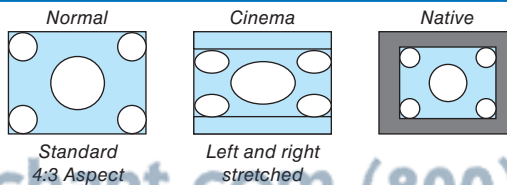

Standard 4:3 Aspect

Left and right stretched

When 16:9 is selected from the source (i.e. DVD player), the following selections will display:

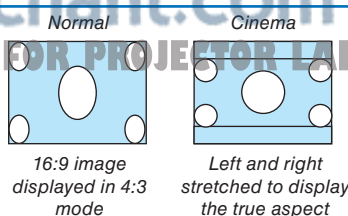

16:9 image displayed in 4:3 mode

Left and right stretched to display the true aspect

Native (RGB only): Turns off the scaling feature. The projector displays the current image in its true resolution.



### NOTE:

- When you are displaying an RGB image with a higher resolution than the projector's native resolution, the image will be displayed in [Normal] even if [Native] is selected. Only when displaying an RGB image with a lower resolution than the projector's native resolution, will the image be able to be displayed in its true resolution [Native].
- When [Normal] is selected, an HDTV (1080i/720p) signal will be shown in its true aspect, as is the case when selecting [Cinema].
- You can adjust the image position for Cinema aspect. See [Cinema Position] for setting the image position.

### Copyright

Please note that using this projector for the purpose of commercial gain or the attraction of public attention in a venue such as a coffee shop or hotel and employing compression or expansion of the screen image with a [Aspect Ratio] setting may raise concern about the infringement of copyrights which are protected by copyright law.

### Adjusting the Vertical Position of Image [Cinema Position] (for Cinema only)

This feature adjusts the vertical position of the image when viewing video with Cinema aspect ratio selected. When [Cinema] is selected in [Aspect Ratio], the image is displayed with black borders on the top and bottom. You can adjust the vertical position from the top to the bottom of the black area.

NOTE: This option is available only when "Cinema" is selected in Aspect Ratio.

### Adjusting Horizontal/Vertical Position, Clock and Phase [Position/Clock]

You can adjust the image manually for position and stability; [Horizontal], [Vertical], [Clock] and [Phase].

[Horizontal/Vertical] (available for RGB signal only)

Adjusts the image location horizontally and vertically.

[Clock] (available for RGB signal only)

Use this item to fine tune the computer image or to remove any vertical banding that might appear. This function adjusts the clock frequencies that eliminate the horizontal banding in the image. This adjustment may be necessary when you connect your computer for the first time.

[Phase] (available for RGB signal only)

Use this item to adjust the clock phase or to reduce video noise, dot interference or cross talk. (This is evident when part of your image appears to be shimmering.)

Use [Phase] only after the [Clock] is complete.

- Performing the [Horizontal], [Vertical], [Clock] or [Phase] function will store the adjustment values of the currently projected source into the projector's memory. The next time the same source (same resolution, horizontal and vertical frequencies) is projected; the projector will call up from memory the stored values for the source. To clear the stored adjustment values, select the [Reset] → [Current Signal] or [All Data] from the menu to re-set the adjustment values.

### Turning on Noise Reduction [Noise Reduction]

Turn on or off the noise reduction feature. To reduce video noise, select On.

FixYourDLP.com

Sponsored by

- This feature is not available for 480p, 576p, 720p, 1080i and RGB signals
- Noise reduction set to off gives best image quality by way of higher bandwidth. Noise reduction set to on softens the image.

### Setting Telecine Mode [Telecine]

Use 3:2 or 2:2 pull down correction to eliminate jitter and artifacts in video.

Auto..... For film source such as a DVD player.

Off ..... For signals other than film sources.

NOTE: This feature is not available for 480p, 576p, 720p, 1080i and RGB signals

## 6 Menu Descriptions & Functions [Setup]

### [Setup - General]

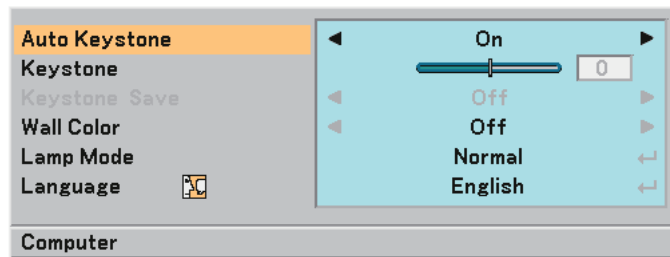

#### Enabling Auto Keystone [Auto Keystone]

This feature allows the projector to detect its tilt and correct vertical distortion automatically. To turn on the Auto Keystone feature, select "On".

#### Correcting Vertical Keystone Distortion Manually [Keystone]

You can correct vertical distortion manually. (→ page 25)

*TIP: When this option is highlighted, pressing the ENTER button will display its slide bar for adjustment.*

#### Saving Vertical Keystone Correction [Keystone Save]

This option enables you to save your current keystone settings.

- Off ..... Does not save current keystone correction settings
- On..... Saves current keystone correction settings

Saving your change once affects all sources. The changes are saved when the projector is off.

*NOTE: When [Auto Keystone] is set to [On], [Keystone Save] is not available. Next time you turn on the power, the Auto Keystone function will work and the data stored with [Keystone Save] will be invalid.*

#### Selecting Wall Color Correction Mode [Wall Color]

This function allows for quick adaptive color correction in applications where the screen material is not white. The following 9 options are available: Off, Blackboard, Blackboard (Gray), Light yellow, Light green, Light blue, Sky blue, Light rose and Pink.

#### Selecting Lamp Mode [Lamp Mode]

This feature enables you to select two brightness modes of the lamp: Normal and Eco modes. The lamp life can be extended by using the Eco mode.

- Normal Mode ..... This is the default setting (100% Brightness).
- Eco Mode ..... Select this mode to increase the lamp life and reduce fan noise (NP60: approx. 80% Brightness, NP50/ NP40: approx. 90% Brightness).

*NOTE:*

- The Lamp Mode can be changed by using the menu. Select [Setup] → [General] → [Lamp Mode].
  - The lamp life remaining and lamp hours used can be checked in [Usage Time]. Select [Information] → [Usage Time].
  - If the projector is overheated in Normal mode, there may be a case where the Lamp mode automatically changes to Eco mode to protect the projector. When the projector is in Eco mode, the picture brightness decreases. When the projector comes back to normal temperature, the Lamp mode returns to Normal mode.
- Thermometer symbol [🌡️] indicates the lamp mode is automatically set to Eco mode because the internal temperature is too high.*

#### Selecting Menu Language [Language]

You can choose one of 20 languages for the on-screen menu.

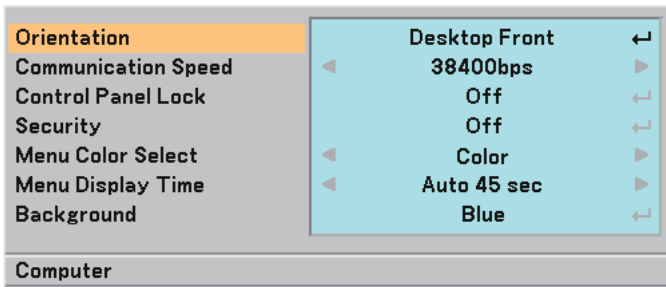
**[Setup - Installation]****Selecting Projector Orientation [Orientation]**

This sets your image for your type of projection application. The options are: desktop front projection, ceiling rear projection, desktop rear projection, and ceiling front projection.

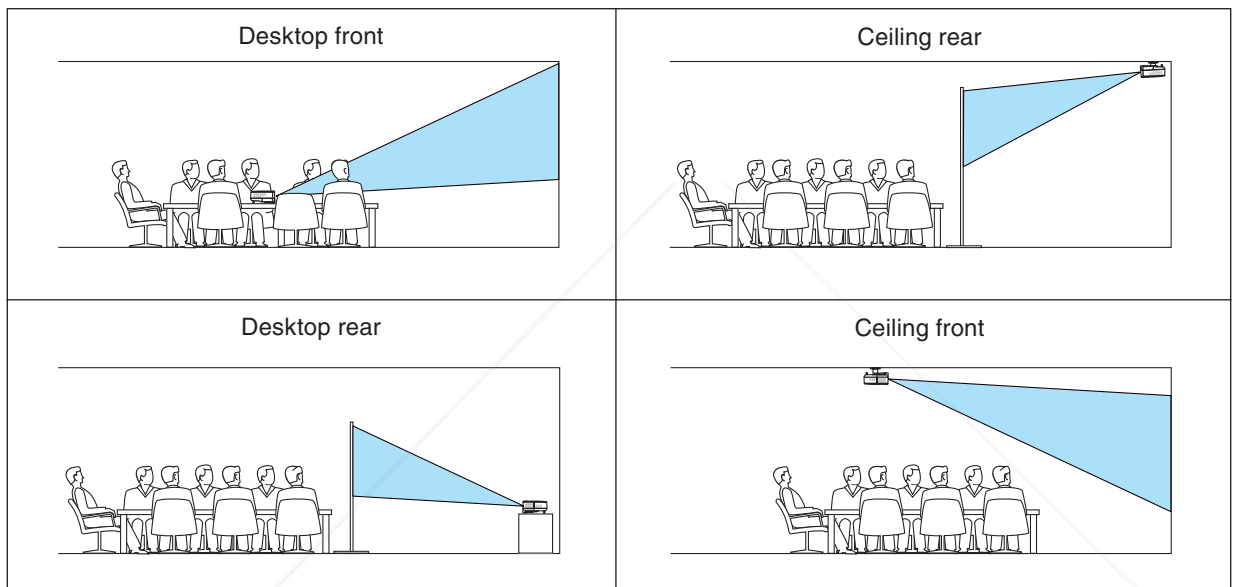
**Selecting Communication Speed [Communication Speed]**

This feature sets the baud rate of the PC Control port (Mini DIN 8 Pin). It supports data rates from 4800 to 38400 bps.

The default is 38400 bps.

Select the appropriate baud rate for your equipment to be connected (depending on the equipment, a lower baud rate may be recommended for long cable runs).

*NOTE: Your selected communication speed will not be affected even when [Reset] is done from the menu.*

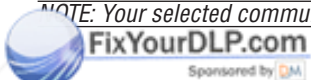
**Disabling the Cabinet Buttons [Control Panel Lock]**

This option turns on or off the Key Lock function for cabinet buttons.

*NOTE:*

- The Control Panel Lock setting will not affect the remote control or PC Control Functions.
- When the cabinet buttons are disabled, pressing and holding the EXIT button for about 10 seconds will change the setting to enable.
- The Key Lock icon will be displayed at the bottom right of the menu when Control Panel Lock is enabled.

### **Enabling Security [Security]**

This feature turns on or off the Security function.

Unless the correct keyword is entered, the projector cannot project an image. (→ page 28)

### **Selecting Menu Color [Menu Color Select]**

You can choose between two color modes for menu color: color and monochrome.

### **Selecting Menu Display Time [Menu Display Time]**

This option allows you to select how long the projector waits after the last touch of a button to turn off the menu.

The preset choices are “Manual”, “Auto 5 sec”, “Auto 15 sec”, and “Auto 45 sec”.

### **Selecting a Color for Background [Background]**

Use this feature to display a blue/black screen when no signal is available.

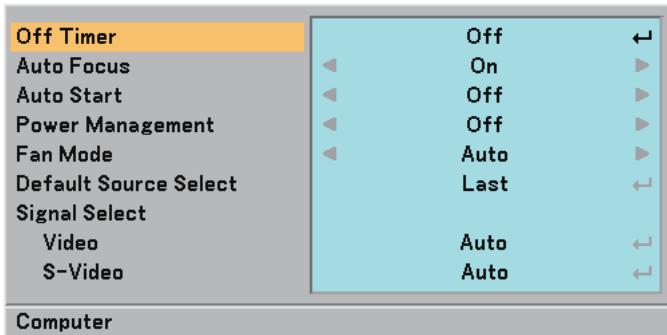

**Discount-Merchant.com (800) 281-8860**  
**THE TRUSTED SOURCE FOR PROJECTOR LAMPS AND ACCESSORIES**

**[Setup - Options]****Setting Off Timer [Off Timer]**

You can use the Off Timer feature to turn off the projector automatically at a preset time. Eight preset times can be selected: Off, 0:30, 1:00, 2:00, 4:00, 8:00, 12:00 and 16:00.

**Enabling or Disabling Auto Focus [Auto Focus]**

This option turns on or off the Auto Focus feature. (→ page 22)

**NOTE:**

When the "Auto Focus" is on, the Auto Focus function works instantly under the following conditions:

- When you turn on the power.
- When you change the zoom.
- When you reposition the projector.
- When you change the projection angle.

**Enabling Auto Start [Auto Start]**

Turns the projector on automatically when the power cable is inserted into an active power outlet. This eliminates the need to always use the POWER button on the remote control or projector cabinet.

**Enabling Power Management [Power Management]**

When this option is selected you can enable the projector to automatically turn off (at the selected time: 5min., 10min., 20min., 30min.) if there is no signal received by any input.

**Enabling Fan Speed Mode [Fan Mode]**

This option allows you to select two modes for fan speed: Auto mode and High speed mode.

Auto..... The built-in fans automatically run at a variable speed according to the internal temperature.

High..... The built-in fans run at a fixed high speed.

When you wish to cool down the temperature inside the projector quickly, select [High].

*NOTE: It is recommended that you select High speed mode if you continue to use the projector for consecutive days.*

**Selecting Default Source [Default Source Select]**

can set the projector to default to any one of its inputs each time the projector is turned on.

Last ..... Sets the projector to default to the previous or last active input each time the projector is turned on.

Auto..... Searches for an active source in order of Computer → Video → S-Video → Computer and displays the first found source.

Computer..... Displays the RGB source (COMPUTER IN) every time the projector is started up.

Video..... Displays the Video source (VIDEO IN) every time the projector is started up.

S-Video ..... Displays the Video source (S-VIDEO IN) every time the projector is started up.

**Selecting Signal Format [Signal Select]**

[Video & S-Video System Select]

This feature enables you to select video standards automatically or manually.

In the case where the projector has difficulty detecting the video standard, select the appropriate video standard from the menu. This must be done for Video and S-Video respectively.

*TIP: The projector automatically detects a component signal.*

**7 Menu Descriptions & Functions [Information]**

Displays the status of the current signal and lamp usage. This item has three pages. The information included is as follows:

**[Usage Time]**

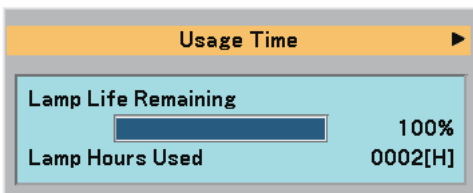

[Lamp Life Remaining] (%)\*

[Lamp Hours Used] (H)

\* The progress indicator shows the percentage of remaining bulb life.

The value informs you of the amount of lamp usage. When the remaining lamp time reaches 0, the Remaining Lamp Time bar indicator changes from 0% to 100 Hours and starts counting down.

If the remaining lamp time reaches 0 hours, the projector will not turn on regardless of whether the lamp mode is set to Normal or Eco.

Product	Lamp life(H)		Replacement lamp
	Normal	Eco	
NP60	2000	3000	NP03LP
NP50/NP40			NP02LP

**[Source]**

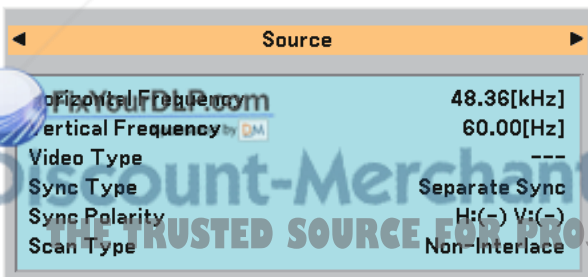

[Horizontal Frequency]

[Vertical Frequency]

[Video Type]

[Sync Type]

[Sync Polarity]

[Scan Type]

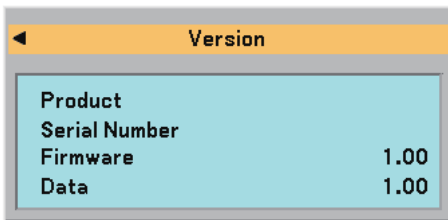
**[Version]**

[Product]  
 [Serial Number]  
 [Firmware] Version  
 [Data] Version

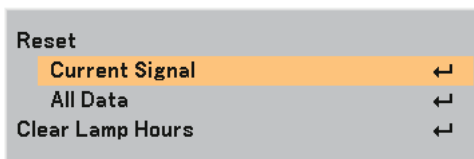
**8 Menu Descriptions & Functions [Reset]****Returning to Factory Default [Reset]**

The Factory Default feature allows you to change adjustments and settings to the factory preset for a (all) source (s) except the following:

**[Current Signal]**

Resets the adjustments for the current signal to the factory preset levels.

The items that can be reset are: [Preset], [Contrast], [Brightness], [Color], [Hue], [Sharpness], [Aspect Ratio], [Horizontal Position], [Vertical Position], [Clock], [Phase], [Noise Reduction], and [Telecine].

**[All Data]**

Reset all the adjustments and settings for all the signals to the factory preset.

All items can be reset except [Language], [Background], [Communication Speed], [Security], [Lamp Life Remaining], and [Lamp Hours Used].

To reset the lamp usage time, see "Clearing Lamp Hour Meter [Clear Lamp Hours]" below.

**Clearing Lamp Hour Meter [Clear Lamp Hours]**

Resets the lamp clock back to zero. Selecting this option displays submenu for a confirmation.

*NOTE: Elapsed time of the lamp use will not be affected even when [Reset] is done from the menu.*

*The projector will turn off and go into standby mode after 2100 hours (up to 3100 hours in Eco mode) of service.*

*If this happens, press the HELP button on the remote control for 10 seconds to reset the lamp clock back to zero.*

*When the lamp time clock is reset to zero, the LAMP indicator goes out.*

*Do this only after replacing the lamp.*

**THE TRUSTED SOURCE FOR PROJECTOR LAMPS AND ACCESSORIES**

## 6. Maintenance

This section describes the simple maintenance procedures you should follow to clean the focus sensor, lens and replace the lamp and the cooling pump.

### ① Cleaning the Lens and Focus Sensor

#### Cleaning the lens

Use a blower or lens paper to clean the lens, and be careful not to scratch or mar the lens.

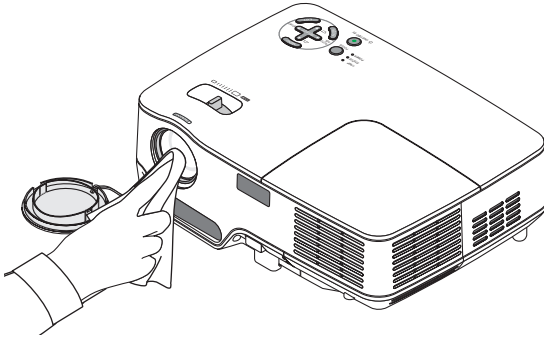

#### Cleaning the focus sensor

Use a blower or lens paper to clean the focus sensor.

Keep finger prints off the focus sensor. Leaving finger prints in the focus sensor might cause poor focus or short auto focus range.

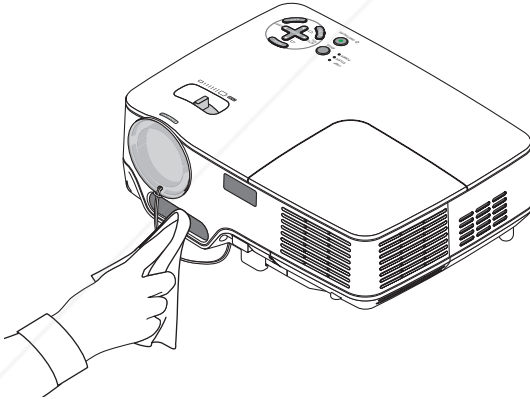

### ② Cleaning the Cabinet

1. Turn off the projector before cleaning.
2. Vacuum the ventilation inlet of the cabinet.

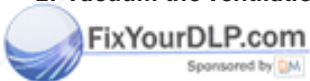

Discount-Merchant.com (800) 281-8860  
THE TRUSTED SOURCE FOR PROJECTOR LAMPS AND ACCESSORIES

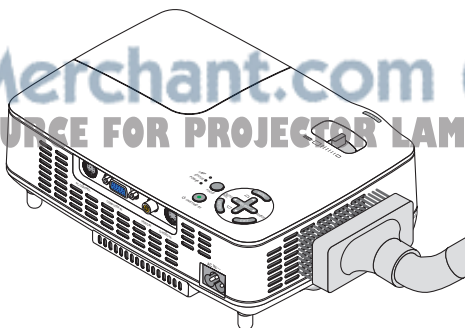



### ③ Replacing the Lamp and the Cooling Pump

After your lamp has been operating for 2000 hours (up to 3000 hours in Eco mode) or longer, the LAMP indicator in the cabinet will blink red and the message **[The lamp has reached the end of its usable life. Please replace the lamp.]** will appear. Even though the lamp may still be working, replace it at 2000 (up to 3000 hours in Eco mode) hours to maintain optimal projector performance. After replacing the lamp, be sure to clear the lamp hour meter. (→ page 46)

#### CAUTION

- The optional lamp comes with the cooling pump.  
After replacing the lamp, be sure to replace the cooling pump, too.
- DO NOT TOUCH THE LAMP immediately after it has been used. It will be extremely hot. Turn the projector off and then disconnect the power cable. Allow at least one hour for the lamp to cool before handling.
- DO NOT REMOVE ANY SCREWS except two lamp case screws. You could receive an electric shock.
- Do not break the glass on the lamp housing.  
Keep finger prints off the glass surface on the lamp housing. Leaving finger prints in the glass surface might cause an unwanted shadow and poor picture quality.
- The projector will turn off and go into standby mode after 2100 (up to 3100 hours in Eco mode) hours of service. If this happens, be sure to replace the lamp. If you continue to use the lamp after 2000 hours (up to 3000 hours in Eco mode) of use, the lamp bulb may shatter, and pieces of glass may be scattered in the lamp case. Do not touch them as the pieces of glass may cause injury. If this happens, contact your NEC dealer for lamp replacement.

#### To replace the lamp:

Optional lamp, cooling pump and tools needed for replacement:

- Replacement lamp with cooling pump: NP03LP (NP60) or NP02LP (NP50/NP40)
- Phillips screwdriver or equivalent

**1. Place the projector on a soft cloth and turn it over to access the lamp cover on the bottom.**

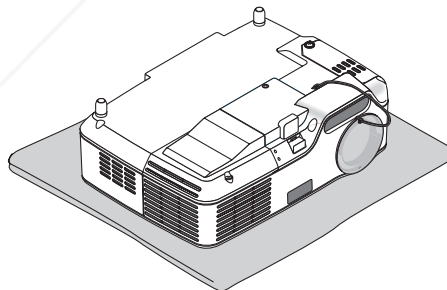

**2. Loosen the lamp cover screw until the screwdriver goes into a freewheeling condition and remove the lamp cover.**

*The lamp cover screw is not removable.*

FixYourDLP.com

Sponsored by DM

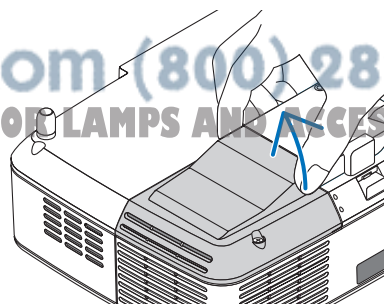
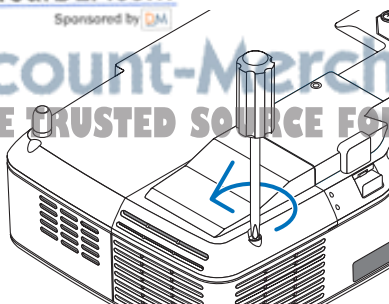

Discount-Merchant.com (800) 281-8860  
THE TRUSTED SOURCE FOR PROJECTOR LAMPS AND ACCESSORIES

**3. Loosen the two screws securing the lamp housing until the phillips screwdriver goes into a freewheeling condition.**

The two screws are not removable.

Remove the lamp housing by holding the handle.

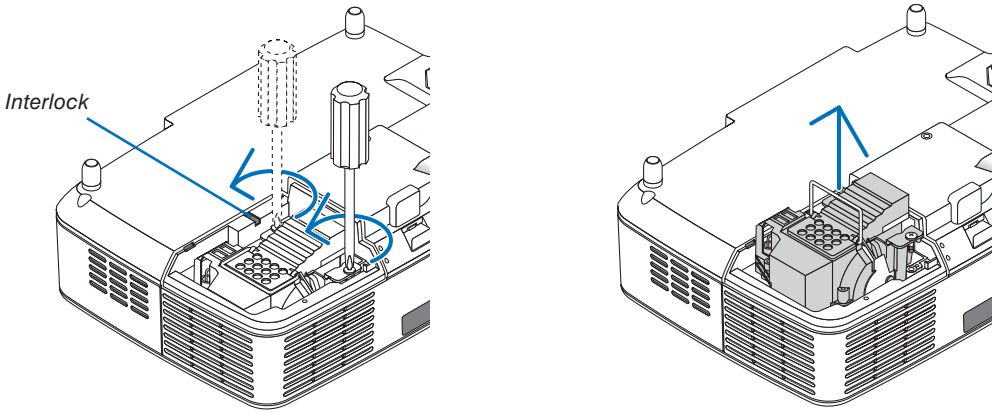

*NOTE: There is an interlock on this case to prevent the risk of electrical shock. Do not attempt to circumvent this interlock.*

**4. Push the part as shown on the drawing and insert a new lamp housing until it is plugged into the socket.**

**CAUTION**

Do not use a lamp other than the NEC replacement lamp NP03LP (NP60) or NP02LP (NP50/NP40). Order this from your NEC dealer.

**Secure it in place with the two screws.**

*NOTE: Tighten the two screws alternately until both screws are completely tightened. Failure to do this can result in air leak from the cooling pump, causing the pump error. (→ page 52)*

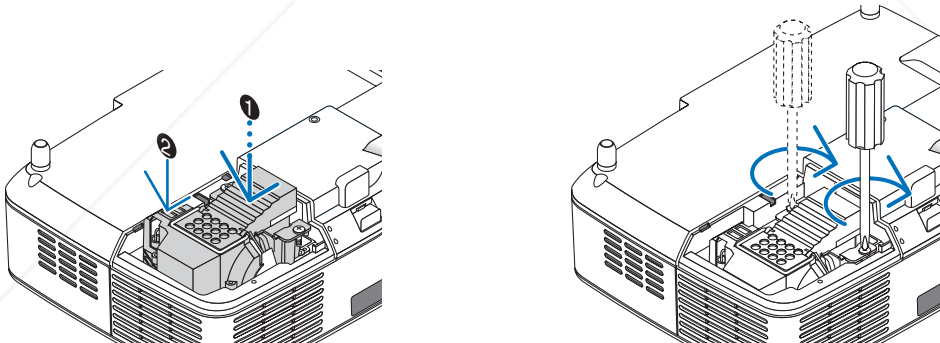

**5. Reattach the lamp cover.**

Tighten the lamp cover screw.  
Be sure to tighten the screw.

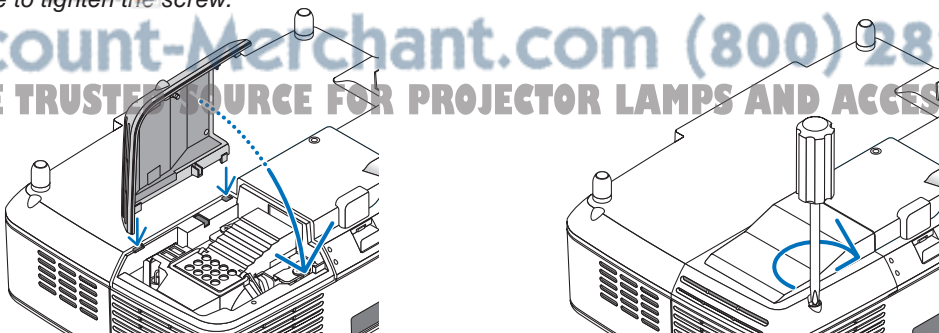

Discount-Merchant.com (800) 281-8860  
THE TRUSTED SOURCE FOR PROJECTOR LAMPS AND ACCESSORIES

This completes the lamp replacement.  
Go on to the cooling pump replacement.

To replace the cooling pump:

**6. Remove the cooling pump.**

- (1) Loosen the cooling pump cover screw until the screwdriver goes into a freewheeling condition.  
- The cooling pump cover screw is not removable.

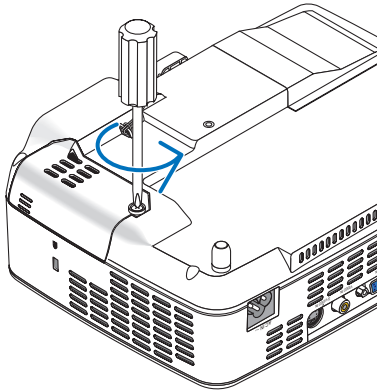

- (2) Remove the cooling pump cover.

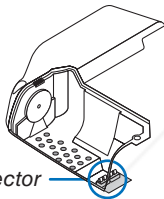

Contact area of the connector

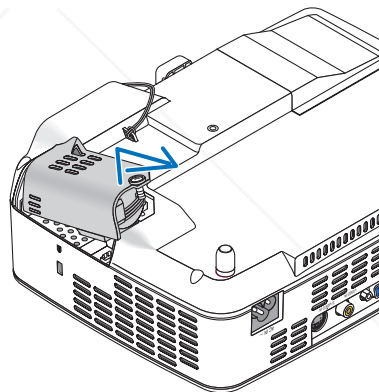

*NOTE: Keep the contact area of the connector clean. If there are dust and dirt in the contact area of the connector, remove them.*

**7. Install a new cooling pump.**

- (1) Align the tabs on the cooling pump cover with the guide on the cabinet and slide the cooling pump cover.

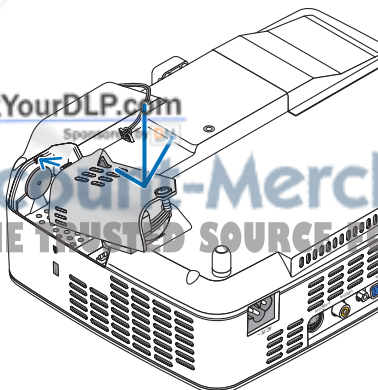

FixYourDLP.com  
Discount-Merchant.com (800) 281-8860  
THE TRUSTED SOURCE FOR PROJECTOR LAMPS AND ACCESSORIES

- (2) Tighten the cooling pump cover screw.  
- Be sure to tighten the cooling pump cover screw.

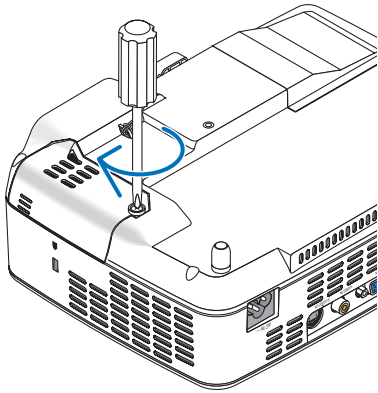

This completes the cooling pump replacement.  
Go on to the next step.

8. Connect the supplied power cable and turn on the projector.
9. Finally, select the menu → [Reset] → [Clear Lamp Hours] to reset the lamp usage hours.

*NOTE: When the lamp exceeds 2100 hours (up to 3100 hours in Eco mode) of service, the projector cannot turn on and the menu is not displayed.*

*If this happens, press the HELP button on the remote control for 10 seconds to reset the lamp clock back to zero. When the lamp time clock is reset to zero, the LAMP indicator goes out.*



**Discount-Merchant.com (800) 281-8860**  
**THE TRUSTED SOURCE FOR PROJECTOR LAMPS AND ACCESSORIES**

# 7. Appendix

## 1 Troubleshooting

This section helps you resolve problems you may encounter while setting up or using the projector.

### Indicator Messages

#### Power Indicator

Indicator Condition		Projector Condition	Note
Off		The main power is off	–
Blinking light	Green	0.5 sec On, 0.5 sec Off	The projector is getting ready to turn on.
		2.5 sec On, 0.5 sec Off	Off Timer is enabled.
	Orange	0.5 sec On, 0.5 sec Off	The projector is cooling down.
Steady light	Green	The projector is turned on.	–
	Orange	The projector is in Standby.	–

#### Status Indicator

Indicator Condition		Projector Condition	Note
Off		Normal	–
Blinking light	Red	1 cycle (0.5 sec On, 2.5 sec Off)	Lamp cover error or lamp housing error
		2 cycle (0.5 sec On, 0.5 sec Off)	Temperature error
		3 cycle (0.5 sec On, 0.5 sec Off)	Power error
		4 cycle (0.5 sec On, 0.5 sec Off)	Fan error
		6 cycle (0.5 sec On, 0.5 sec Off)	Lamp error
		8 cycle (0.5 sec On, 0.5 sec Off)	Cooling pump error
	Green	Re-firing the lamp (The projector is cooling down.)	
Steady light	Orange	Control Panel Lock is on.	

#### Lamp Indicator

Indicator Condition		Projector Condition	Note
Off		Normal	–
Blinking light	Red	Lamp has reached its end of life. Lamp replacement message will be displayed.	
	Red	Lamp has been used beyond its limit. The projector will not turn on until the lamp is replaced.	
	Green	Lamp mode is set to Eco mode.	

#### Over-Temperature Protection

If the temperature inside the projector rises too high, the over-temperature protector will automatically turn off the lamp with the STATUS indicator blinking (2-cycle On and Off.)

Should this happen, do the following:

- Unplug the power cable after the cooling fans stop.
- Move the projector to a cooler location if the room where you are presenting is particularly too warm.
- Clean the ventilation holes if they are clogged with dust.
- Wait about 60 minutes until the inside of the projector becomes cool enough.

## Common Problems &amp; Solutions (→ "Power/Status/Lamp Indicator" on page 52.)

Problem	Check These Items
Does not turn on	<ul style="list-style-type: none"> <li>• Check that the power cable is plugged in and that the power button on the projector cabinet or the remote control is on. (→ page 15, 16)</li> <li>• Ensure that the lamp cover is installed correctly. (→ page 49)</li> <li>• Ensure that the two screws on the lamp housing are completely tightened. (→ page 49)</li> <li>• Ensure that the cooling pump is installed correctly. (→ page 50)</li> <li>• Check to see if the projector has overheated. If there is insufficient ventilation around the projector or if the room where you are presenting is particularly warm, move the projector to a cooler location.</li> <li>• Check to see if the lamp usage exceeds 2100 hours (up to 3100 hours : Eco mode). If so, replace the lamp. After replacing the lamp, reset the lamp hours used. (→ page 46)</li> <li>• The lamp may fail to light. Wait a full minute and then turn on the power again.</li> </ul>
Will turn off	<ul style="list-style-type: none"> <li>• Ensure that the Power Management or Off Timer is off. (→ page 44)</li> </ul>
No picture	<ul style="list-style-type: none"> <li>• Use the COMPUTER, the VIDEO or the S-VIDEO button on the remote control to select your source (Computer, Video or S-Video). (→ page 18) If there is still no picture, press the button again.</li> <li>• Ensure your cables are connected properly.</li> <li>• Use menus to adjust the contrast and brightness. (→ page 39)</li> <li>• Check to see if the image is muted. (→ page 28)</li> <li>• Remove the lens cap.</li> <li>• Reset the settings or adjustments to factory preset levels using the [Reset] in the Menu. (→ page 46)</li> <li>• Enter your registered keyword if the Security function is enabled. (→ page 28)</li> <li>• Be sure to connect the projector and notebook PC while the projector is in standby mode and before turning on the power to the notebook PC. In most cases the output signal from the notebook PC is not turned on unless connected to the projector before being powered up. * If the screen goes blank while using your remote control, it may be the result of the computer's screen-saver or power management software.</li> <li>• See also the next page.</li> </ul>
Picture suddenly becomes dark	<ul style="list-style-type: none"> <li>• When one of the following happens, the Lamp mode automatically changes from Normal to Eco. * When there are no signals (blue or black screen) → To return to the Normal mode, select another available source. * When the room where you're presenting is particularly warm → Move the projector to a cooler location.</li> </ul>
Color tone or hue is unusual	<ul style="list-style-type: none"> <li>• Check if an appropriate color is selected in [Wall Color]. If not, select an appropriate option. (→ page 41)</li> <li>• Adjust [Hue] in [Picture]. (→ page 39)</li> </ul>
Image isn't square to the screen	<ul style="list-style-type: none"> <li>• Reposition the projector to improve its angle to the screen. (→ page 20, 21)</li> <li>• Use the Keystone correction function to correct the trapezoid distortion. (→ page 25)</li> </ul>
Picture is blurred	<ul style="list-style-type: none"> <li>• Make sure that focus is appropriate.</li> <li>• Reposition the projector to improve its angle to the screen. (→ page 20, 21)</li> <li>• Ensure that the distance between the projector and screen is within the adjustment range of the lens. (→ page 10)</li> <li>• Make sure that the distance between the focus sensor and the screen is within the effective range of the Auto Focus. (→ page 22)</li> <li>• Make sure that the requirements for the Auto Focus are met. (→ page 22)</li> <li>• Condensation may form on the lens if the projector is cold, brought into a warm place and is then turned on. Should this happen, let the projector stand until there is no condensation on the lens.</li> </ul>
Image is scrolling vertically, horizontally or both	<ul style="list-style-type: none"> <li>• Use the COMPUTER, the VIDEO or the S-VIDEO button on the remote control to select your source (Computer, Video or S-Video). (→ page 18)</li> <li>• Adjust the computer image manually with the Horizontal and Vertical in the [Image Options] → [Position/Clock]. (→ page 40)</li> </ul>
Remote control does not work	<ul style="list-style-type: none"> <li>• Install new batteries. (→ page 8)</li> <li>• Make sure there are no obstacles between you and the projector.</li> <li>• Stand within 22 feet (7 m) of the projector. (→ page 8)</li> </ul>
Indicator is lit or blinking	<ul style="list-style-type: none"> <li>• See the POWER/STATUS/LAMP Indicator. (→ page 52)</li> </ul>
Cross color in RGB mode	<ul style="list-style-type: none"> <li>• Press the AUTO ADJ. button on the remote control (SELECT ◀ button on the projector cabinet). (→ page 26)</li> <li>• Adjust the computer image manually with [Clock] and [Phase] in [Image Options] → [Position/Clock] in the menu. (→ page 40)</li> </ul>

For more information contact your dealer.

**If there is no picture, or the picture is not displayed correctly.**

- Power on process for the projector and the PC.

Be sure to connect the projector and notebook PC while the projector is in standby mode and before turning on the power to the notebook PC.

In most cases the output signal from the notebook PC is not turned on unless connected to the projector before being powered up.

*NOTE: You can check the horizontal frequency of the current signal in the projector's menu under Information. If it reads "0kHz", this means there is no signal being output from the computer. See page 45 or go to next step.*

- Enabling the computer's external display.

Displaying an image on the notebook PC's screen does not necessarily mean it outputs a signal to the projector. When using a PC compatible laptop, a combination of function keys will enable/disable the external display. Usually, the combination of the 'Fn' key along with one of the 12 function keys gets the external display to come on or off. For example, NEC laptops use Fn + F3, while Dell laptops use Fn + F8 key combinations to toggle through external display selections.

- Non-standard signal output from the computer

If the output signal from a notebook PC is not an industry standard, the projected image may not be displayed correctly. Should this happen, deactivate the notebook PC's LCD screen when the projector display is in use. Each notebook PC has a different way of deactivate/reactivate the local LCD screens as described in the previous step. Refer to your computer's documentation for detailed information.

- Image displayed is incorrect when using a Macintosh

When using a Macintosh with the projector, set the DIPswitch of the Mac adapter (not supplied with the projector) according to your resolution. After setting, restart your Macintosh for the changes to take affect.

For setting display modes other than those supported by your Macintosh and the projector, changing the DIP switch on a Mac adapter may bounce an image slightly or may display nothing. Should this happen, set the DIP switch to the 13" fixed mode and then restart your Macintosh. After that, restore the DIP switches to a displayable mode and then restart the Macintosh again.

*NOTE: A Video Adapter cable manufactured by Apple Computer is needed for a PowerBook which does not have a mini D-Sub 15-pin connector.*

- Mirroring on a PowerBook

\* When using the projector with a Macintosh PowerBook, output may not be set to 1024 x 768 unless "mirroring" is off on your PowerBook. Refer to owner's manual supplied with your Macintosh computer for mirroring.

Folders or icons are hidden on the Macintosh screen

Folders or icons may not be seen on the screen. Should this happen, select [View] → [Arrange] from the Apple menu and arrange icons.

## ② Specifications

This section provides technical information about the NP60/NP50/NP40 projector's performance.

<b>Model Number</b>	<b>NP60/NP50/NP40</b>
<b>Optical</b>	
DMD	Single Chip Digital Micromirror Device (DMD)
Resolution	1024 x 768 pixels* up to UXGA (1600 x 1200) with scaling technology
Lens	Manual zoom and auto focus (effective range: 57.1"/1.5 m - 216.5"/5.5 m) / manual focus F2.2 - 2.34, f = 20.4 mm - 24.5 mm
Lamp	NP60: 220W AC (180W Eco mode) NP50/NP40: 200W AC (180W Eco mode)
Light Output**	NP60: 3000 lumens (approx. 80% in Eco mode) NP50: 2600 lumens (approx. 90% in Eco mode) NP40: 2200 lumens (approx. 90% in Eco mode)
Contrast Ratio (full white: full black)	NP60/NP50: 1600: 1 NP40: 1500:1
Image Size (Diagonal)	33" - 300" diagonal (4:3) (image sizes with less than 40" are available only in tele mode)
Projection Distance	57" - 439" (wide) - 57" - 529" (tele) 1.5 - 11.1 m (wide) - 1.5- 13.4 m (tele)
Projection Angle	14.7° - 15.0° (wide) / 12.3° - 12.6° (tele)
<b>Electrical</b>	
Inputs	1 VGA shared with component video (Mini D-Sub 15 Pin), 1 S-Video (Mini DIN 4 Pin), 1 Video (RCA), 1 PC Control (Mini DIN 8 Pin)
Video Compatibility	NTSC, NTSC4.43, PAL, PAL-60, PAL-N, PAL-M, SECAM, Component : 1080i, 720p, 576p, 480p, 576i, 480i
Scan Rate	Horizontal: 15 kHz to 100 kHz (RGB: 24 kHz or over) Vertical: 50 Hz to 85 Hz
Color Reproduction	16.7 million colors simultaneously, Full color
Horizontal Resolution	NTSC / NTSC4.43/PAL / PAL-60/PAL-N/PAL-M/YCbCr: 540 TV lines SECAM: 300 TV lines RGB: 1024 dots (H) x 768 dots (V) IR, RS232C
Sync Compatibility	Separate Sync / Composite Sync / Sync on Green / Sync on Video
Power Requirement/Input Current:	NP60 : 100-240 V AC, 3.2 - 1.3 A NP50/NP40 : 100-240 V AC, 3.0 - 1.2 A NP60G : 200-240 V AC, 50/60 Hz, 1.5 A NP50G/40G : 200-240 V AC, 50/60 Hz, 1.4 A

\* Effective pixels are more than 99.99%.

\*\* This is the light output value (lumens) when the [Preset] mode is set to [High-Bright]. If any other mode is selected as the [Preset] mode, the light output value may drop slightly.



Power Consumption	NP60: 285W in Lamp Normal mode, 240W in Lamp Eco mode, 6.0W in Standby mode NP50/NP40: 265W in Lamp Normal mode, 240W in Lamp Eco mode, 6.0W in Standby mode
-------------------	---

**Mechanical**

Installation Orientation	Desktop/Front, Desktop/Rear, Ceiling/Front, Ceiling/Rear
Dimensions	9.7" (W) x 2.8" (H) x 7.0" (D) 246 mm (W) x 72 mm (H) x 177 mm (D) (not including protrusions)
Net Weight	3.5 lbs / 1.6 kg
Environmental Considerations	Operational Temperatures: 41°F to 104°F / 5°C to 40°C (Eco mode selected automatically at 95°F to 104°F/35°C to 40°C) 20% to 80% humidity (non-condensing) Storage Temperatures: 14°F to 122°F (-10°C to 50°C), 20% to 80% humidity (non-condensing)
Regulations	<i>For United States:</i> UL Approved (UL 60950-1) Meets FCC Class B requirements <i>For Canada:</i> UL Approved (CSA 60950-1) Meets DOC Canada Class B requirements <i>For Australia/New Zealand:</i> Meets AS/NZS CISPR.22 Class B <i>For Europe:</i> Meets EMC Directive (EN55022, EN55024, EN61000-3-2, EN61000-3-3) Meets Low Voltage Directive (EN60950-1, TÜV GS Approved)



For additional information visit:

US : <http://www.necvisualsystems.com>

Europe : <http://www.neceurope.com/>

Global : <http://www.nec-pj.com/>

For information on our optional accessories, visit our website or see our brochure.



Specifications are subject to change without notice.

Sponsored by DM

**Discount-Merchant.com (800) 281-8860**  
**THE TRUSTED SOURCE FOR PROJECTOR LAMPS AND ACCESSORIES**

### 3 Cabinet Dimensions

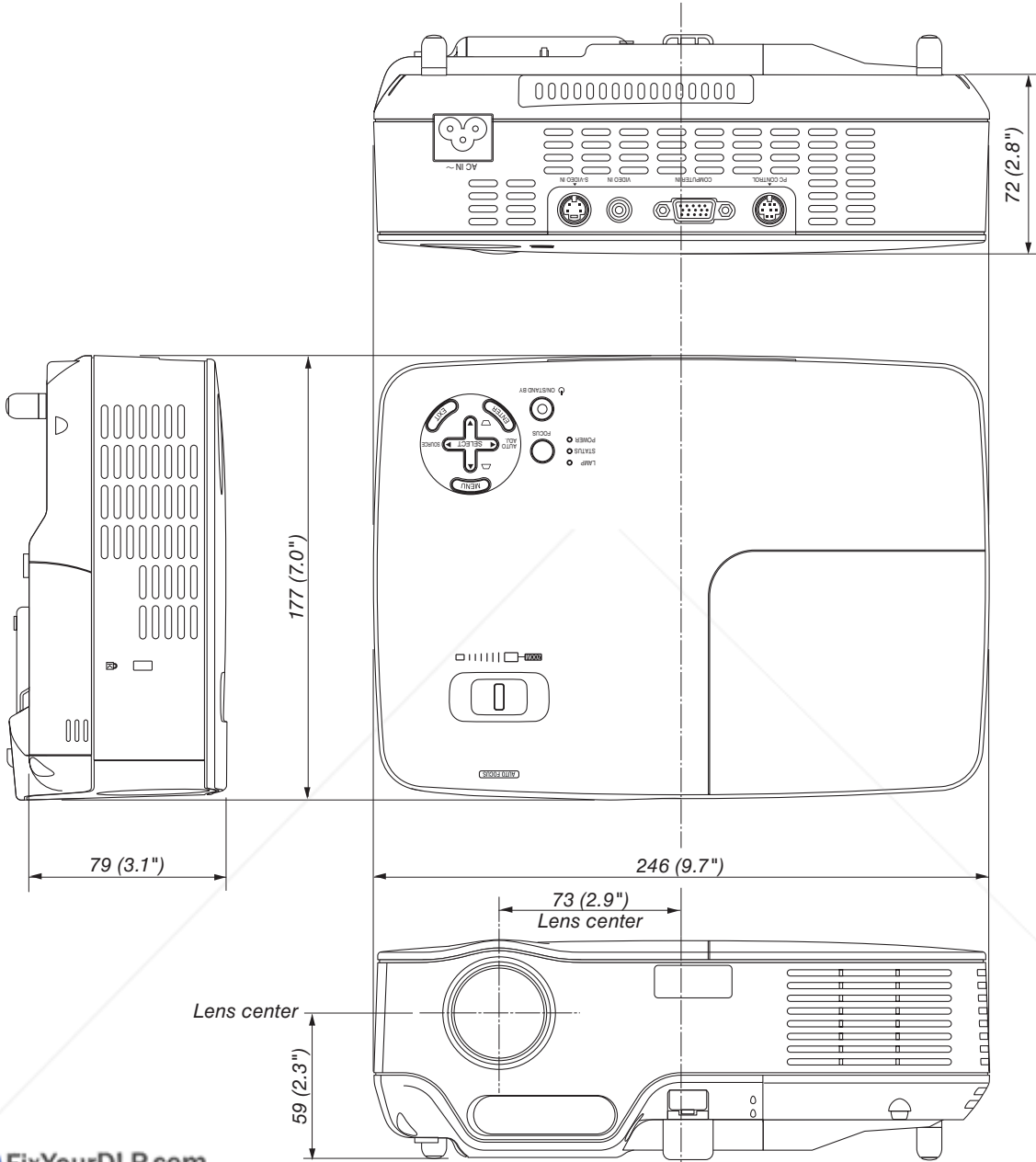

**Discount-Merchant.com (800) 281-8860** Unit: mm (inch)  
THE TRUSTED SOURCE FOR PROJECTOR LAMPS AND ACCESSORIES

## ④ Pin Assignments of D-Sub COMPUTER Input Connector

### Mini D-Sub 15 Pin Connector

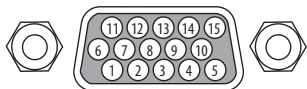

Signal Level

Video signal : 0.7Vp-p (Analog)

Sync signal : TTL level

Pin No.	RGB Signal (Analog)	YCbCr Signal
1	Red	Cr
2	Green or Sync on Green	Y
3	Blue	Cb
4	Ground	
5	Ground	
6	Red Ground	Cr Ground
7	Green Ground	Y Ground
8	Blue Ground	Cb Ground
9	No Connection	
10	Sync Signal Ground	
11	No Connection	
12	Bi-directional DATA (SDA)	
13	Horizontal Sync or Composite Sync	
14	Vertical Sync	
15	Data Clock	

## 5 Compatible Input Signal List

Horizontal: 15 kHz to 100 kHz (RGB: 24 kHz or over)

Vertical: 50 Hz to 85 Hz

Signal	Resolution ( Dots )	Frequency H. ( kHz )	Refresh Rate ( Hz )
NTSC	–	15.73	60.00
PAL	–	15.63	50.00
PAL60	–	15.73	60.00
SECAM	–	15.63	50.00
VESA	640 × 480	31.47	59.94
IBM	640 × 480	31.48	59.95
MAC	640 × 480	35.00	66.67
VESA	640 × 480	37.86	72.81
VESA	640 × 480	37.50	75.00
IBM	640 × 480	39.38	75.00
VESA	640 × 480	43.27	85.01
IBM	720 × 350	31.47	70.08
VESA	800 × 600	35.16	56.25
VESA	800 × 600	37.88	60.32
VESA	800 × 600	48.08	72.19
VESA	800 × 600	46.88	75.00
VESA	800 × 600	53.67	85.06
MAC	832 × 624	49.72	74.55
VESA	1024 × 768	48.36	60.00
VESA	1024 × 768	56.48	70.07
MAC	1024 × 768	60.24	74.93
VESA	1024 × 768	60.02	75.03
VESA	1024 × 768	68.68	85.00
# SUN	1152 × 900	61.80	65.95
# VESA	1280 × 960	60.00	60.00
# VESA	1280 × 1024	63.98	60.02
# MAC	1280 × 1024	69.87	65.18
# SXGA+	1400 × 1050	–	60.00
# VESA	1600 × 1200	75.00	60.02
# VESA	1600 × 1200	87.50	70.00
# VESA	1600 × 1200	93.75	75.00
# HDTV (1080i)	1920 × 1080	33.75	60.00 Interlace
# HDTV (1080i)	1920 × 1080	28.13	50.00 Interlace
# HDTV (720p)	1280 × 720	45.00	60.00 Progressive
# HDTV (720p)	1280 × 720	37.50	50.00 Progressive
SDTV(576p)	–	31.25	50.00 Progressive
SDTV(480p)	–	31.47	59.94 Progressive
DVD YCbCr	–	15.73	59.94 Interlaced
DVD YCbCr	–	15.63	50.00 Interlaced

# : Signals above flagged with # are compressed with scaling technology.

### NOTE:

- Signals other than those specified in the table above may not be displayed correctly. If this should happen, change the refresh rate or resolution on your PC. Refer to Display Properties help section of your PC for procedures.
- UXGA (1600 x 1200) is supported for separate sync signal only.

## ⑥ PC Control Codes and Cable Connection

### PC Control Codes

Function	Code Data							
POWER ON	02H	00H	00H	00H	00H	02H		
POWER OFF	02H	01H	00H	00H	00H	03H		
INPUT SELECT COMPUTER	02H	03H	00H	00H	02H	01H	01H	09H
INPUT SELECT VIDEO	02H	03H	00H	00H	02H	01H	06H	0EH
INPUT SELECT S-VIDEO	02H	03H	00H	00H	02H	01H	0BH	13H
PICTURE MUTE ON	02H	10H	00H	00H	00H	12H		
PICTURE MUTE OFF	02H	11H	00H	00H	00H	13H		

*NOTE: Contact your local dealer for a full list of the PC Control Codes if needed.*

### Cable Connection

#### Communication Protocol

Baud rate.....38400 bps

Data length.....8 bits

Parity.....No parity

Stop bit.....One bit

X on/off .....None

Communications procedure .....Full duplex

*NOTE: Depending on the equipment, a lower baud rate may be recommended for long cable runs.*

### PC Control Connector (DIN-8P)

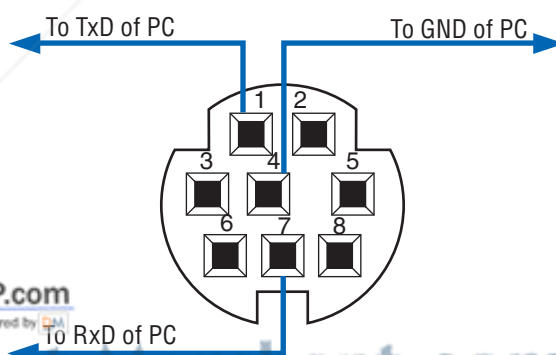

FixYourDLP.com  
Sponsored by

Discount-Merchant.com (800) 281-8860

*NOTE: Pins 2, 3, 5 and 6 are used inside the projector.*

THE TRUSTED SOURCE FOR PROJECTOR LAMPS AND ACCESSORIES

## 7 Troubleshooting Check List

Before contacting your dealer or service personnel, check the following list to be sure repairs are needed also by referring to the "Troubleshooting" section in your user's manual. This checklist below will help us solve your problem more efficiently.

\* Print this page and the next page for your check.

**Frequency of occurrence**  always  sometimes (How often? \_\_\_\_\_)  other (\_\_\_\_\_)

### Power

- No power (POWER indicator does not light green)  
See also "Status Indicator (STATUS)".
  - Power cable's plug is fully inserted into the wall outlet.
  - The power cable has been unplugged and plugged quickly during projection.
  - Lamp cover is installed correctly.
  - The two screws on the lamp housing are completely tightened.
  - The cooling pump is installed correctly.
  - Lamp Hour Used (lamp operation hours) was cleared after lamp replacement.
  - No power even though you press and hold the POWER button for a minimum of 1 second.
- Shut down during operation.
  - Power cable's plug is fully inserted into the wall outlet.
  - Lamp cover is installed correctly .
  - Power Management is turned off (only models with the Power Management function).
  - Off Timer is turned off (only models with the Off Timer function).

### Video

- No image is displayed from your PC or video equipment to the projector.
  - Still no image even though you connect the projector to the PC first, then start the PC.
  - Enabling your notebook PC's signal output to the projector.
    - *A combination of function keys will enable/disable the external display. Usually, the combination of the "Fn" key along with one of the 12 function keys turns the external display on or off.*
- No image (blue background, black background).
  - Still no image even though you press the AUTO ADJ. button.
  - Still no image even though you carry out [Reset] in the projector's menu.
  - Signal cable's plug is fully inserted into the input connector.
  - A message appears on the screen.  
( \_\_\_\_\_ )
  - The source connected to the projector is active and available.
  - Still no image even though you adjust the brightness and/or the contrast.
  - Input source's resolution and frequency are supported by the projector.
- Image is too dark.
  - Remains unchanged even though you adjust the brightness and/or the contrast.
- Image is distorted.
  - Image appears to be trapezoidal (unchanged even though you carry out the [Keystone] adjustment).
- Parts of the image are lost.
  - Still unchanged even though you press the AUTO ADJ. button.
  - Still unchanged even though you carry out [Reset] in the projector's menu.
- Image is shifted in the vertical or horizontal direction.
  - Horizontal and vertical positions are correctly adjusted on a computer signal.
  - Input source's resolution and frequency are supported by the projector.
  - Some pixels are lost.
- Image is flickering.
  - Still unchanged even though you press the AUTO ADJ. button.
  - Still unchanged even though you carry out [Reset] in the projector's menu.
  - Image shows flickering or color drift on a computer signal.
- Image appears blurry or out of focus.
  - Auto Focus is turned on.
  - There are no objections between the focus sensor and the screen.  
The throw distance is within 1.5 to 5.5 m/57.1" to 216.5".  
Image is projected onto the screen.
  - Still unchanged even though you adjusted the focus manually.

### Other

- Remote control does not work.
  - No obstacles between the sensor of the projector and the remote control.
  - Projector is placed near a fluorescent light that can disturb the infrared remote controls.
  - Batteries are new and are not reversed in installation.
- Buttons on the projector cabinet do not work ( only models with the Key Lock function).
  - Control Panel Lock is not turned on or is disabled in the menu.
  - Still unchanged even though you press and hold the EXIT button for a minimum of 10 seconds.

In the space below please describe your problem in detail.

Information on application and environment where your projector is used

### Projector

Model number:

Serial No.:

Date of purchase:

Lamp operating time (hours):

Lamp Mode:  Normal  Eco

Information on input signal:

Horizontal synch frequency [     ] kHz

Vertical synch frequency [     ] Hz

Synch polarity            H  (+)  (-)

                                  V  (+)  (-)

Synch type                 Separate  Composite

Sync on Green

STATUS Indicator:

Steady light                 Orange  Green

Flashing light            [     ] cycles

Remote control model number:

### Installation environment

Screen size:    inch

Screen type:  White matte  Beads  Polarization  
 Wide angle  High contrast

Throw distance:                feet/inch/m

Orientation:  Ceiling mount  Desktop

Power outlet connection:

Connected directly to wall outlet

Connected to power cord extender or other (the number of connected equipment \_\_\_\_\_)

Connected to a power cord reel or other (the number of connected equipment \_\_\_\_\_)

### Computer

Manufacturer:

Model number:

Notebook PC  / Desktop

Native resolution:

Refresh rate:

Video adapter:

Other:

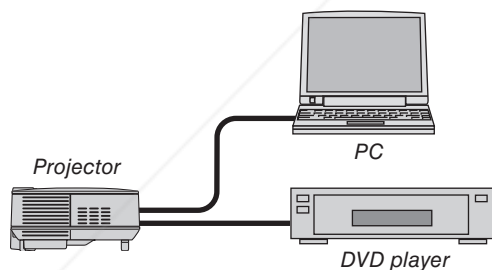

### Signal cable

NEC standard or other manufacturer's cable?

Model number: \_\_\_\_\_ Length: \_\_\_\_\_ inch/m

Distribution amplifier

Model number: \_\_\_\_\_

Switcher

Model number: \_\_\_\_\_

Adapter

Model number: \_\_\_\_\_

### Video equipment

VCR, DVD player, Video camera, Video game or other

Manufacturer:

Model number:

## 8 TravelCare Guide

### TravelCare - a service for international travelers

This product is eligible for "TravelCare", NEC's unique international warranty. Please note that TravelCare coverage differs in part from coverage under the warranty included with the product.

#### Services offered with TravelCare

This warranty allows customers to receive service on their product at the NEC and NEC-designated service stations in the countries listed herein when temporarily traveling internationally for business or pleasure.

For details on services offered by the different service stations, please refer to the "List of TravelCare Outlets" below.

#### 1 Repair services

The product will be repaired and delivered within 10 business days, not including shipping time.

During the term of warranty, the cost of maintenance parts, labor costs for repairs and shipping costs within the service station's coverage area are covered by the warranty.

#### 2 Replacement product rental service

If the customer desires, he or she can rent a replacement product while the original product is being repaired.

Fee: US\$200 for 12 days

This fee must be paid at the local service station in cash or credit card.

The US\$200 rental fee is non-refundable even if the customer rents it less than 12 days before returning.

The replacement product will be delivered within 3 business days.

If the customer did not return the replacement product within 12 days, the customer will be charged the price of the unit.

If the customer returned the replacement product in a faulty or damaged condition, the repair cost will be charged to the customer.

Note that this service is not offered in all countries and regions. Please refer to the "List of TravelCare Outlets".

In addition, this replacement product rental service is not offered after the product's warranty has expired.

#### Term of warranty

1

- a. Upon presentation of the warranty or receipt received upon purchase:

Valid for the term indicated on the warranty or the normal term of warranty for the country of purchase.

- b. When only the product is brought in:

Valid for a period of within 14 months of the date of manufacture indicated by the serial number attached to the product.

- 2 When a product whose term of warranty is expired is brought in:

Repairs will be offered for a fee. In this case the customer is not eligible for the replacement product rental service.

- 3 In the following cases, repairs may be charged, even if the product's warranty is still in effect:

- 1) If the term of warranty, model name, serial number and name of the store of purchase are not indicated on the warranty or have been altered.

- 2) Problems or damage caused by dropping or shocks during shipment or movement by the customer or by improper handling by the customers.

Problems or damage caused by improper usage or unwarrantable alterations or repairs by the customer.

- 4) Problems or damage caused by fire, salt damage, gas damage, earthquakes, lightning damage, storm or flood damage or other natural disasters or such external factors as dust, cigarette smoke, abnormal voltage, etc.

- 5) Problems or damage caused by use in hot or humid places, in vehicles, boats or ships, etc.

- 6) Problems or damage caused by expendable supplies or devices connected to the product other than those designated by NEC.

- 7) Problems caused by natural consumption, wear or deterioration of parts under normal usage conditions.

- 8) Problems or damage to lamps and other expendable supplies, included parts or optional parts.

- 9) Other conditions stipulated in the warranty included with the product also apply.

*NOTE: The product can be used overseas with voltages indicated in the rating label on the product by using a power cable suited for the standards and power source voltage of the country in which the product is being used.*

#### List of TravelCare Outlets

This list applies as of July 1, 2006.

For the most up-to-date information, please refer to the websites of the service stations in the various countries on the List of TravelCare Outlets or to the NEC website at <http://www.nec-pj.com>.

#### In Europe

NEC Europe, Ltd. / European Technical Centre

Address: Unit G, Stafford Park 12, Telford TF3 3BJ, U.K.  
 Telephone: +44 1952 237000  
 Fax Line: +44 1952 237006  
 Email Address: [AFR@uk.neceur.com](mailto:AFR@uk.neceur.com)  
 WEB Address: <http://www.neceur.com>

(Regions Covered)

EU: Austria\*, Belgium\*, Denmark\*, Finland\*, France\*, Germany\*, Greece\*, Ireland\*, Italy\*, Luxembourg\*, The Netherlands\*, Portugal\*, Spain\*, Sweden\* and the United Kingdom\*  
 EEA: Norway\*, Iceland and Liechtenstein

#### In North America

NEC Corporation of America

Address: 1250 N. Arlington Heights Road,  
 Itasca, Illinois 60143, U.S.A.  
 Telephone: +1 800 836 0655  
 Fax Line: +1 800 356 2415  
 Email Address: [vsd.tech-support@necsam.com](mailto:vsd.tech-support@necsam.com)  
 WEB Address: <http://www.necvisualsystems.com>

(Regions Covered)

U.S.A. \*, Canada\*

#### In Oceania

NEC Australia Pty., Ltd.

*New South Wales;*

Address: 184 Milperra Road, Reversby NSW 2212  
 Telephone: +61 2 9780 8688  
 Fax Line: +61 2 9780 8659

*Victoria;*

Address: Unit 1/6 Garden Road, Clayton VIC 3168  
 Telephone: +61 3 8562 6245  
 Fax Line: +61 3 8562 6220

*Newcastle;*

Address: 120 Parry Street Newcastle West NSW 2300  
 Telephone: +61 2 4926 2466

*Queensland;*

Address: Unit 4/305 Montague Road West End QLD 4101  
 Telephone: +61 7 3840 5858  
 Fax Line: +61 7 3840 5866

*Goldcoast QLD;*

Address: Shop1 48 Ferry Road Southport QLD 4215  
 Telephone: +61 7 5591 3670

*South Australia;*

Address: 84A Richmond Road, Keswick SA 5035  
 Telephone: +61 8 8375 5707  
 Fax Line: +61 8 8375 5757

*Western Australia;*

Address: 45 Sarich Court Osborne Park WA 6017  
 Telephone: +61 8 9445 5901  
 Fax Line: +61 8 9445 5999

WEB Address: <http://www.nec.com.au>

(Regions Covered)

Australia\*, New Zealand



**In Asia and Middle East****NEC Viewtechnology, Ltd.**

Address: 686-1, Nishioi, Oi-Machi, Ashigarakami-Gun,  
Kanagawa 258-0017, Japan  
Telephone: +81 465 85 2369  
Fax Line: +81 465 85 2393  
Email Address: support\_pjweb@nevt.nec.co.jp  
WEB Address: <http://www.nec-pj.com>

(Regions Covered)  
Japan\*

**NEC Hong Kong Ltd.**

Address: 25/F., The Metropolis Tower, 10 Metropolis Drive,  
Hunghom, Kowloon, Hong Kong  
Telephone: +852 2369 0335  
Fax Line: +852 2795 6618  
Email Address: nechksc@nechk.nec.com.hk  
esmond\_au@nechk.nec.com.hk  
WEB Address: <http://www.nec.com.hk>

(Regions Covered)  
Hong Kong

**NEC Taiwan Ltd.**

Address: 7F, No.167, SEC.2, Nan King East Road, Taipei,  
Taiwan, R.O.C.  
Telephone: +886 2 8500 1714  
Fax Line: +886 2 8500 1420  
Email Address: chenguanfu@nec.com.tw  
WEB Address: <http://www.nec.com.tw>

(Regions Covered)  
Taiwan

**NEC Solutions Asia Pacific Pte. Ltd**

Address: 401 Commonwealth Drive, #07-02, Haw Par  
Technocentre, Singapore 149598  
Telephone: +65 6 273 8333  
Fax Line: +65 6 274 2226  
Email Address: tehgh@rsc.ap.nec.com.sg  
WEB Address: <http://www.nec.com.sg/ap>

(Regions Covered)  
Singapore

**NEC Systems Integration Malaysia Sdn Bhd**

Address: Ground Floor, Menara TA One, 22, Jalan P. Ramlee,  
50250 Kuala Lumpur, Malaysia  
Telephone: +6 03 2178 3600 (ISDN)  
Fax Line: +6 03 2178 3789  
Email Address: necare@nsm.nec.co.jp  
WEB Address: <http://www.necarecenter.com>

(Regions Covered)  
Malaysia

**Tele Service Co., Ltd.**

Address: 2nd Fl., Ire B/D. #2, 4Ga, Yangpyeng-Dong,  
Yongdaungpo-Gu, Seoul, Korea 150-967  
Telephone: +82 2 2163 4193  
Fax Line: +82 2 2163 4196  
Email Address: moneybear@hyosung.com

(Regions Covered)  
South Korea

**Lenso Communication Co., Ltd.**

Address: 292 Lenso House 4, 1st Floor, Srinakarin Road,  
Huamark, Bangkapi, Bangkok 10240, Thailand  
Telephone: +66 2 375 2425  
Fax Line: +66 2 375 2434  
Email Address: pattara@lenso.com  
WEB Address: <http://www.lenso.com>

(Regions Covered)  
Thailand

**ABBA Electronics L.L.C.**

Address: Tariq Bin Ziyad Road, P.O.Box 327, Dubai,  
United Arab Emirates  
Telephone: +971 4 371800  
Fax Line: +971 4 364283  
Email Address: ABBA@emirates.net.ae

(Regions Covered)  
United Arab Emirates

**Samir Photographic Supplies**

Address: P.O.Box 599, Jeddah 21421, Saudi Arabia  
Telephone: +966 2 6828219  
Fax Line: +966 2 6830820  
Email Address: asif@samir-photo.com

**Riyadh**

Address: P.O.Box 5519, Riyadh 11432, Saudi Arabia  
Telephone: +966 1 4645064  
Fax Line: +966 1 4657912  
Email Address: bhimji@samir-photo.com

**Alkhobar**

Address: P.O.Box 238, Alkhobar 31952, Saudi Arabia  
Telephone: +966 3 8942674  
Fax Line: +966 3 8948162  
Email Address: chamsedin@samir-photo.com

(Regions Covered)  
Saudi Arabia

*NOTE: In countries designated with an asterisk(\*), replacement product rental service are offered.*

Date: / / ,

P-1/ ,

**TO: NEC or NEC's Authorized Service Station:**

**FM:**

\_\_\_\_\_  
 (Company & Name with signature)

Dear Sir (s),

I would like to apply your TravelCare Service Program based on attached registration and qualification sheet and agree with your following conditions, and also the Service fee will be charged to my credit card account, if I don't return the Loan units within the specified period. I also confirm following information is correct. Regards.

***Application Sheet for TravelCare Service Program***

Country, product purchased :	
User's Company Name :	
User's Company Address : Phone No., Fax No. :	
User's Name :	
User's Address :	
Phone No., Fax No. :	
Local Contact office :	
Local Contact office Address :	
Phone No., Fax No. :	
User's Model Name :	
Date of Purchase :	
Serial No. on cabinet :	
Problem of units per User :	
Required Service :	(1) Repair and Return      (2) Loan unit
Requested period of Loan unit :	
Payment method :	(1) Credit Card      (2) Travelers Cheque      (3) Cash
In Case of Credit Card : Card No. w/Valid Date :	

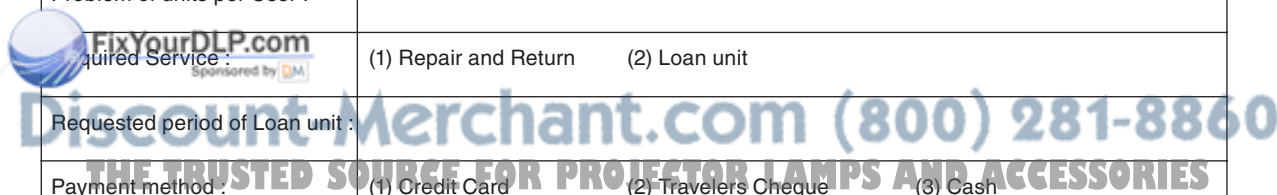

## Condition of your TravelCare Service Program

Enduser is requested to understand following condition of Travel-Care Service Program and complete the necessary information on the application sheet.

### 1. Service Options:

There are 3 types of "Service" available. Enduser has to understand following condition and is required to fill in the Application Sheet.

#### 1) Repair and Return:

The 'Faulty unit' is sent or collected from the customer. It is repaired and returned within 10 days to the customer, excluding transport time.

There may have a case, repair and return can't be done by NEC Authorized Service Station, because of shortage of spare parts due to same model is not sold in the territory.

#### 2) Repair and Return with Loan: (This service is limited to some Service Stations)

This service is offered to the Enduser, who cannot wait until their unit is repaired.

The customer can borrow a unit for \$200 up to 12 days. Customer then sends in inoperable unit to nearest NEC Authorized Service Station for service. In order to prevent collection problem, Enduser is required to fill in Application Sheet.

Enduser needs to confirm the availability of the Service to NEC Authorized Service Stations.

#### 3) Loan Only:

For this service, NEC Authorized Service Station supplies the customer with a loan unit for US\$200 up to 12 days. Customer keeps the inoperable unit and when customer returns home, customer arranges to have the projector serviced in the home country.

## 2. Warranty Exclusions:

This program does not apply if the Projector's serial number has been defaced, modified or removed.

If, in the judgement of NEC Authorized Service Station or its agent the defects or failures result from any cause other than fair wear and tear or NEC neglect, or fault including the following without limitation:

- 1) Accidents, transportation, neglect, misuse, abuse, water, dust, smoke or default of or by the Customer its employees or agents or any third party;
  - 2) Failure or fluctuation of electrical power, electrical circuitry, air conditioning, humidity control or other environmental conditions such as use it in smoking area;
  - 3) Any fault in the attachments or associated products or components (whether or not supplied by NEC or its agents which do not form part of the Product covered by this warranty);
  - 4) Any act of God, fire, flood, war, act of violence or any similar occurrence;
  - 5) Any attempt by any person other than any person authorized by NEC to adjust, modify, repair, install or service the product.
- By Cross-border charges such as, duty, insurance, tax etc.

## 3. Charges for Warranty Exclusions and Out of Warranty Case:

In case faulty unit is under warranty exclusions case or under Out of Warranty period, NEC Authorized Service Station will Inform estimation of actual service cost to the Enduser with reason.

## 4. Dead on Arrival (DOA):

Enduser must take this issue up with their original supplier in the country of purchase.

NEC Authorized Service Station will repair the DOA unit as a Warranty repair, but will not exchange DOA unit with new units.

## 5. Loan Service Charges and Conditions:

Upon acceptance of this NEC Projector, Customer agrees to assume liability for this loan unit.

The current cost of use of this loan unit is \$200.00 USD for 12 calendar days.

If Customer does not return the unit within the 12 calendar days, Customer will be charged the next highest cost up to and including the full list price to Credit Cards, which price will be informed by NEC Authorized Service Stations. Please see the attached listing of contacts for each country to arrange for pickup of the loan unit.

If you return to their country of origin with the loan unit, you will be charged additional freight to return the unit to the loaning country.

Thank you for your understanding of this program.



FixYourDLP.com

Sponsored by

FixYourDLP.com (800) 281-8860

THE TRUSTED SOURCE FOR PROJECTOR LAMPS AND ACCESSORIES



# Disclaimer

This user manual is provided as a free service by FixYourDLP.com. FixYourDLP is in no way responsible for the content of this manual, nor do we guarantee its accuracy. FixYourDLP does not make any claim of copyright and all copyrights remain the property of their respective owners.

About FixYourDLP.com

FixYourDLP.com (<http://www.fixyourdlp.com>) is the World's #1 resource for media product news, reviews, do-it-yourself guides, and manuals.

Informational Blog: <http://www.fixyourdlp.com>

Video Guides: <http://www.fixyourdlp.com/guides>

User Forums: <http://www.fixyourdlp.com/forum>

FixYourDLP's Fight Against Counterfeit Lamps:

<http://www.fixyourdlp.com/counterfeits>

## Sponsors:

RecycleYourLamp.org – Free lamp recycling services for used lamps:

<http://www.recycleyourlamp.org>

Lamp Research - The trusted 3rd party lamp research company:

<http://www.lampresearch.com>

Discount-Merchant.com – The worlds largest lamp distributor:

<http://www.discount-merchant.com>



**FixYourDLP.com**

Sponsored by 