



Disclaimer

This user manual is provided as a free service by FixYourDLP.com. FixYourDLP is in no way responsible for the content of this manual, nor do we guarantee its accuracy. FixYourDLP does not make any claim of copyright and all copyrights remain the property of their respective owners.

About FixYourDLP.com

FixYourDLP.com (<http://www.fixyourdpl.com>) is the World's #1 resource for media product news, reviews, do-it-yourself guides, and manuals.

Informational Blog: <http://www.fixyourdpl.com>

Video Guides: <http://www.fixyourdpl.com/guides>

User Forums: <http://www.fixyourdpl.com/forum>

FixYourDLP's Fight Against Counterfeit Lamps:

<http://www.fixyourdpl.com/counterfeits>

Sponsors:

RecycleYourLamp.org – Free lamp recycling services for used lamps:

<http://www.recycleyourlamp.org>

Lamp Research - The trusted 3rd party lamp research company:

<http://www.lampresearch.com>

Discount-Merchant.com – The worlds largest lamp distributor:

<http://www.discount-merchant.com>



FixYourDLP.com

Sponsored by 

BenQ PE8700 Video Projector

User's Manual

Thank you for your purchase of this quality BenQ video projector! It has been designed to provide you with a home theater viewing experience. For the best result, please read this manual carefully as it is your guide through the control menus and operation.

WARNING

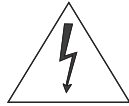
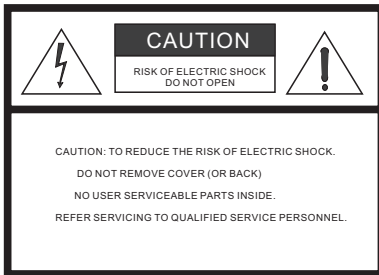

This symbol is intended to alert the user to the presence of uninsulated "dangerous voltage" within the product's enclosure that may be of sufficient magnitude to constitute a risk of electric shock.



This symbol is intended to alert the user to the presence of important operating and maintenance (servicing) instructions in the literature accompanying the appliance.

This equipment has been tested and found to comply with the limits for a Class B digital device, pursuant to Part 15 of the FCC Rules. These limits are designed to provide reasonable protection against harmful interference in a residential installation.

1. Read these instructions.
2. Keep these instructions.
3. Heed all warnings.
4. Do not use this projector near water, outdoors or otherwise exposed to the elements.
5. Clean only with a dry cloth.
6. Do not block any ventilation openings.
7. Do not install near any heat sources such as radiators, heat registers, stoves, or other apparatus (including amplifiers) that produce heat.
8. Do not defeat the safety feature of the polarized or grounding type plug. A polarized type plug has two blades with one wider than the other. A grounding type plug has two blades and a third grounding prong. The third prong is provided for your safety. If the provided plug does not fit into your outlet, consult an electrician for the replacement of the obsolete outlet.
9. The 12V trigger only outputs a DC 12V signal for triggering. Do not connect to any other power input or output. This could cause damage to this unit.
10. Use only accessories specified by BENQ Corporation.
11. Keep the packing material in case the projector should ever need to be shipped.
12. Unplug this projector during lightning storms or when it will not be used for an extended period of time.
13. The lamp becomes extremely hot during operation. Allow the projector to cool down for approximately 45 minutes prior to removing the lamp assembly for replacement. Do not operate lamps beyond the rated lamp life. Excessive operation of lamps beyond rated life could cause them to explode in rare occasions.
14. Refer all servicing to qualified service personnel. Servicing is required when the projector has been damaged in any way, including but not limited to objects having fallen or liquids having been spilled into the projector, exposure to rain or condensing moisture, unexplained failure to operate normally, or the unit having been dropped.

Table of Contents

- BenQ PE8700 Video Projector** 1
- User's Manual** 1
- WARNING** 1
- Table of Contents** 2
- 1. Overview** 3
 - Features 3
 - Location 4
 - Front/Upper Side 4
 - Rear/Bottom Side 4
 - Controls and Functions 5
 - Control Panel 5
 - Connector Panel 6
 - Remote Control 7
- 2. Installation** 8
 - Remote Control 8
 - Projector 8
 - Connect the Power Cord 8
 - Adjust the Lens Zoom/Focus Ring 9
 - Adjust the Height 9
 - Ceiling Installation 10
 - Floor Installation 11
- 3. Connecting** 12
 - Connecting Video Inputs 12
 - Video/ S-Video/ Component (Interlaced Video) 12
 - Progressive Component (DTV Y/PB/PR) 13
 - RGBHV (DTV RGB) 13
 - Connecting a Computer 14
- 4. Basic Operation** 15
 - Turning the Power on 15
 - Zoom/Focusing 15
 - Selecting an Input Source 16
 - Selecting an ASPECT Ratio 16
 - Selecting the Video Memory 17
 - Setting Menu 17
 - PIP (Picture-In-Picture)/POP (Picture-On-Picture) functions 18
 - Turning the Projector Off 18
- 5. Menus** 19
 - Using the Menus 19
 - PICTURE Menu 19
 - DISPLAY Menu 20
 - ENVIRONMENT Menu 22
 - INSTALLATION Menu 22
- 6. Additional Information** 24
 - Warning Message 24
 - Replace the Lamp 24
 - Troubleshooting 25
 - Specifications 26
 - Dimensions 27



Discount Merchant.com (800) 281-8860
 THE TRUSTED SOURCE FOR PROJECTOR LAMPS AND ACCESSORIES

I. Overview

Features

■ Superior Picture Quality

This single-DMD DLP™ projector provides reliable picture quality with contrast ratio and color uniformity.

■ Dynamic Performance and Rich Gray-scale

With a 6-segment color wheel, the projector can attain refresh rates of up to 300 Hz providing dynamic performance and rich gray-scale without the 'color flicker' or 'rainbowing' associated with other single-DMD DLP™ projectors.

■ Sealed Optical Engine with a High-Quality Lens Design

The optical engine uses a high-quality lens for maximizing optical performance. The sealed optical engine prevents light leakage and any dust from entering the engine, which could cause annoying 'spots' in the projected image.

■ Low-Noise Operation

The projector's unique cooling system design prevents annoying fan noise, and is rated at less than 30 dB.

■ Wide Variety of Inputs

The projector can support various video formats, including Composite, S-Video, Component, DTV Y/P_B/P_R, DTV RGB and DVI-I signals. The HDTV input (DTV Y/P_B/P_R and DTV RGB) is accessed through a BNC port, minimizing the amount of signal degradation from longer cable installations.

■ HDTV-Ready

The projector is compatible with 480i, 480P, 576i, 576p, 1080i and 720P formats (via an external DTV decoder, not provided).

■ De-interlacing with 3:2 Pull-Down

Using BenQ's proprietary de-interlacing technology, the projector provides exceptional scaling and film-to-video (3:2 pull-down) conversion for the most artifact-free images possible.

■ PIP/POP function

Picture-in-picture and picture-on-picture functions allow you to display two inputs on the screen at the same time.

■ Video Memory

This projector allows the users to store up to three different settings in the video memories.



Discount-Merchant.com (800) 281-8860
THE TRUSTED SOURCE FOR PROJECTOR LAMPS AND ACCESSORIES

Location

■ Front/Upper Side

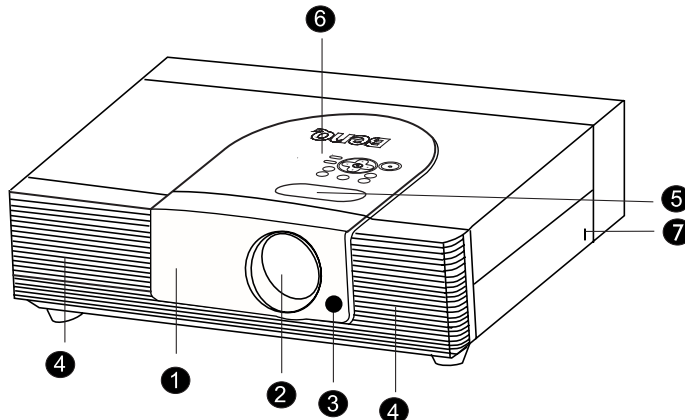

1. Front Lamp Cover

Remove this cover when replacing the lamp.

2. Projection Lens

3. Front IR Sensor

4. Ventilation Holes (exhaust)

5. Focus Ring and Zoom Ring

Adjusts the focus and zoom of the projection lens.

6. Control Panel

Show lamp status and whether the projector is on or off.

For more details, see "Control Panel" on page 5.

7. Kensington Lock

This lock can withstand 150 N of force.

■ Rear/Bottom Side

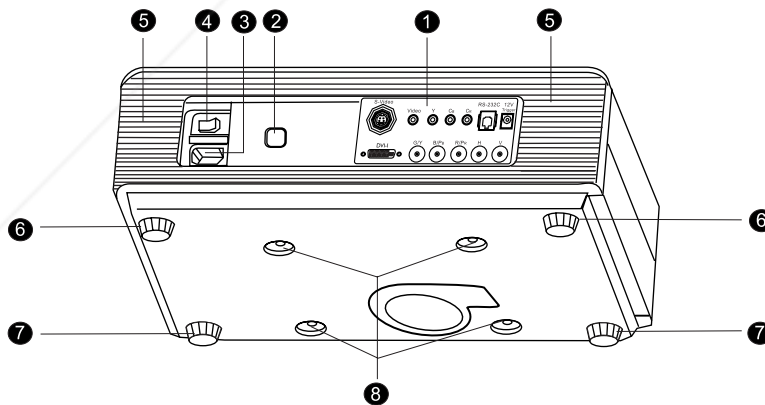

1. Connector Panel

For more details, see "Connector Panel" on page 6.

2. Back IR Sensor

3. AC Power IN Socket.

4. AC Power Switch

AC main power switch.

5. Ventilation Holes (intake)

6. Rear Adjusters

Adjusts the height or projection angle.

7. Front Adjusters

Adjusts the height or projection angle.

8. Ceiling Mount Holes

For attaching the projector to a ceiling mount rack.

FixYourDLP.com
 sponsored by DM
 Discount-Merchant.com (800) 281-8860
 THE TRUSTED SOURCE FOR PROJECTOR LAMPS AND ACCESSORIES

Controls and Functions

■ Control Panel

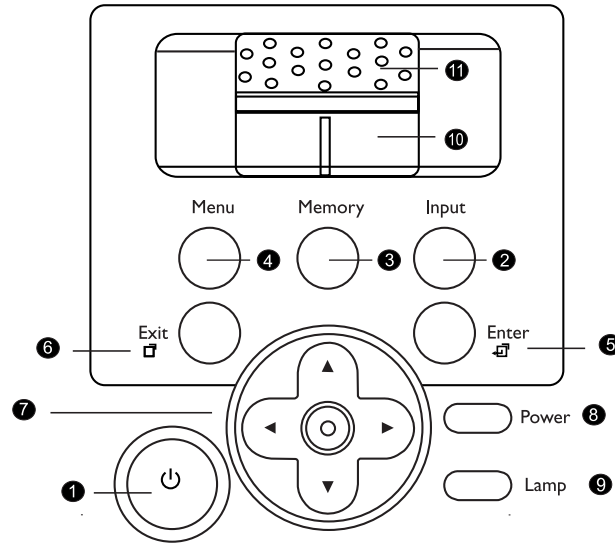

1. **STANDBY/ON**

Press this key for ONE second to turn on the unit when it is in the standby mode. Or press this key to turn off this unit when it is on.

2. **INPUT**

Switches input sources sequentially.

3. **MEMORY**

Sequentially recalls settings 1 ~ 3 saved to memory. (Please see "Selecting the Video Memory" on page 17.)

4. **MENU**

Turns the on-screen display control menu on or off.

5. **ENTER**

Enters settings for items shown in the menu.

6. **EXIT**

Exits and saves the setting(s) of items in the menu.

7. **ARROW (▲/◀/▼/▶)**

Use to select the menu or to make various adjustments.

8. **POWER LED**

Indicates whether the unit is on or off

- Lit orange when the AC power cord is plugged into the wall outlet (standby mode). Once in the standby mode, you can press the STANDBY/ON key on the projector or the ON key on the remote control for ONE second to turn on the projector.
- Lit green when the power is turned on (operational mode).
- Flashes orange for the first 30 seconds after powering up, indicating that the lamp is warming up.
- Flashes green for one minute after the projector is turned off to indicate that the lamp is cooling.

9. **LAMP LED**

Indicates the status of lamp.

- Lit red when the lamp has developed a problem. Please contact your BenQ dealer for assistance.

10. **Zoom Ring**

Adjusts the size of image

- Rotate clockwise to enlarge the image or rotate counterwise to make the image smaller.

11. **Focus Ring**

Adjust the focus of the projected images.

I Connector Panel

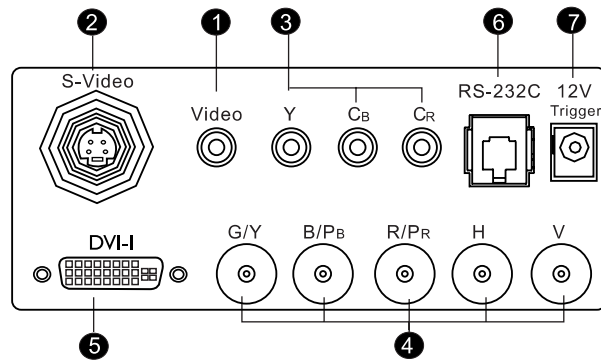

- 1. Video (RCA Jack)**
Composite video signal input.
- 2. S-Video (mini DIN 4-pin)**
Y/C (S-video) signal input
- 3. Component (RCA Jacks)**
480i Component (Y/Cb/CR) video signal input
- 4. RGB/ HDTV (BNC)**
DTV Y/Pb/Pr or DTV RGB video signal input.
- 5. Computer (DVI-I)**
RGB Computer and DVI signal input.
- 6. RS-232C (mini DIN 8-pin)**
RS-232C control signal input.
- 7. 12V Trigger (mini jack)**
+12V output, active when the projector is turned on.

I Remote Control

V (VIDEO): Composite video signal input.

S-V (S-VIDEO): S-Video signal input.

CP (Component): Component Y/Cb/Cr input.

CP HD (Component HD): DTV Y/Pb/Pr signal input.

RGB HD: DTV RGBHV signal input.

PC (DVI): Computer and DVI signal input

DEFAULT

Restores the default settings for the current input source.

Memory 1 : Restores settings saved in memory 1

Memory 2 : Restores settings saved in memory 2

Memory 3 : Restores settings saved in memory 3

ARROW (▲/◀/▼/▶)

Used to select the menu or to make various adjustments.

ENTER

Enters the setting for items shown in the menu.

EXIT

Exits and saves the setting(s) of items in the menu.

MENU

Turns the on-screen display control menu on or off.

SCREEN ▲ : Control the screen up directly. This function is only available for BENQ's accessory screen.

SCREEN ▼ : Control the screen down directly. This function is only available for BENQ's accessory screen.

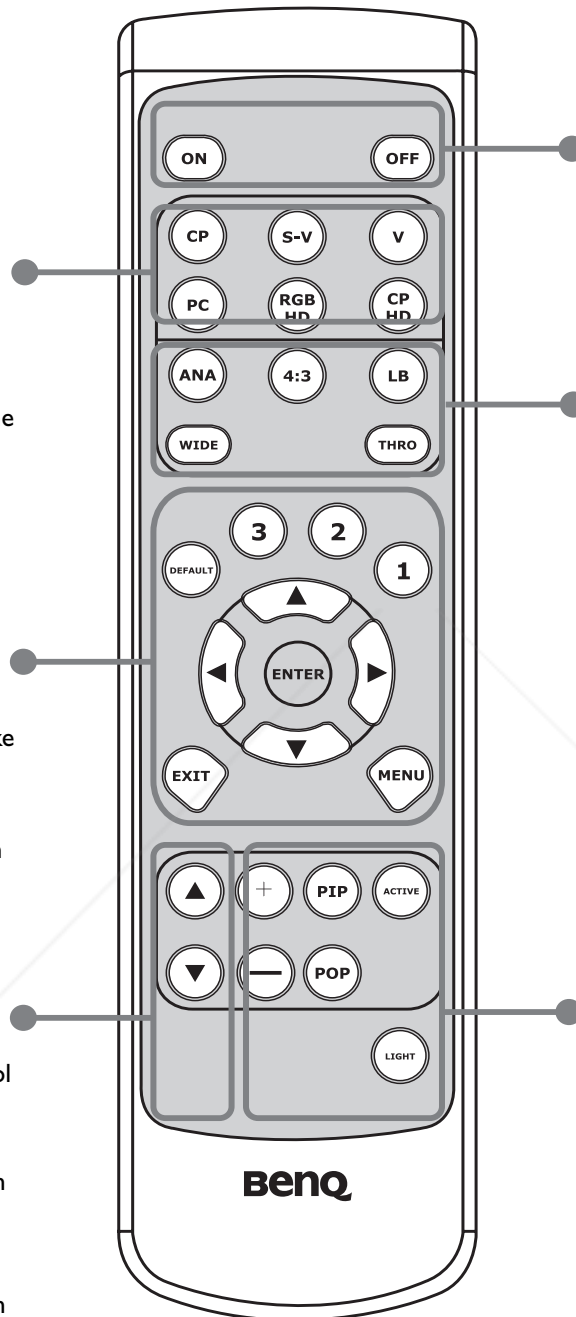

ON

Hold this button down for ONE second to turn the projector on.

OFF

Press this button to turn the projector off.

ANA (ANAMORPHIC): Expands an image with a 4:3 aspect ration linearly along the horizontal axis to provide full-screen display with a 16:9 aspect ration.

STANDARD (4:3): Displays the projected image with a 4: 3 aspect raion in the center of screen.

LB (Letterbox): Enlarges an image in letter box format to display in full-screen format with a 16:9 aspect ration with upper and lower portion cropped.

WIDE: Expands an image with a 4:3 aspect ratio NON-linearly along the horizontal axis to provide full screen display with a 16:9 aspect ratio.

THRO (Through): One-to-one mapping is performing without any scaling of the image. The image is displayed at the center of the screen.

+ : Enlarges the size of the PIP window.

— : Shrinks the size of the PIP window.

PIP (Picture-in-Picture)

Enables the PIP function. Use the ARROW keys to adjust the position of the PIP window (Please see "PIP (Picture-In-Picture)/POP (Picture-On-Picture) functions" on page 18.)

ACTIVE: Switches to the active window in PIP display mode.

POP (Picture-on- picture)

Enables the POP function. Please see "PIP (Picture-In-Picture)/POP (Picture-On-Picture) functions" on page 18.)

LIGHT: Turns the backlight of the remote control on.

2. Installation

Remote Control

Push on the cover and slide it to open. Install two AAA batteries with the correct polarity, then close the cover.

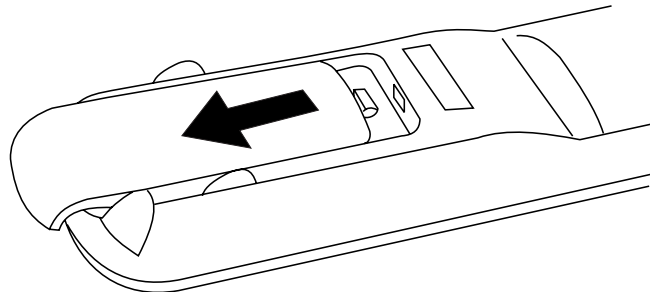

Notes on Batteries

- Make sure that the polarities are correct when installing the batteries.
- Do not mix an old battery with a new one, or mix different types of batteries.
- If the remote control will not be used for an extended period of time, remove the batteries to avoid damage from battery leakage.

Notes on Remote Control Operation

- Make sure that there is nothing between the remote control and the IR receiver on the projector that might obstruct the infrared beam.
- The effective range of the remote control is between 8m (from the front of the projector) and 5m (from the rear of the projector), and within 30 degrees horizontally and 15 degrees vertically.

Projector

■ Connect the Power Cord

Plug the supplied power cord into the AC inlet on the rear of this unit.

Turn on the main power switch at the rear of this unit (next to the AC inlet). The POWER LED will light up in orange. Press the ON key on the remote control or STANDBY/ON key on the projector for ONE second to turn the projector on.

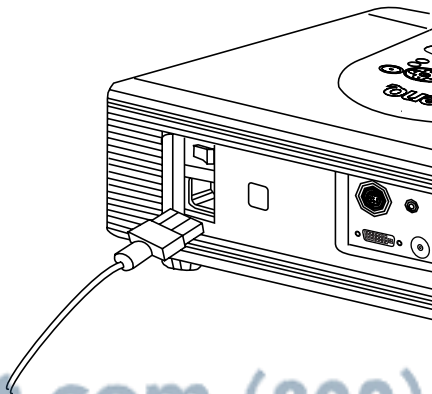

■ Adjust the Lens Zoom/Focus Ring

Adjusts the projected image size you need with the zoom ring on the lens. To focus the image, rotate the focus ring on the lens.

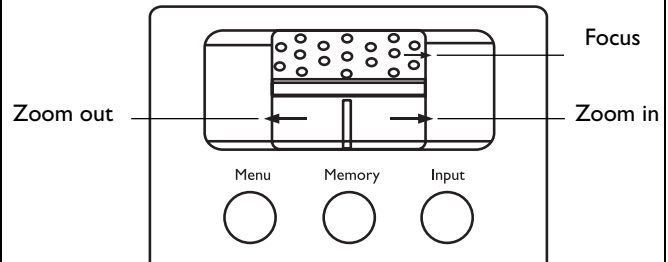

■ Adjust the Height

There are four screw adjusters on the bottom of the projector. You can adjust the height or projection angle by using these adjusters.

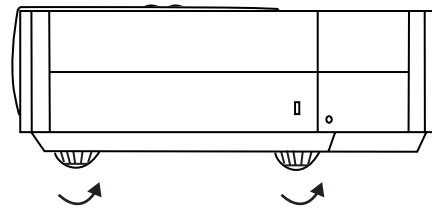

Ceiling Installation

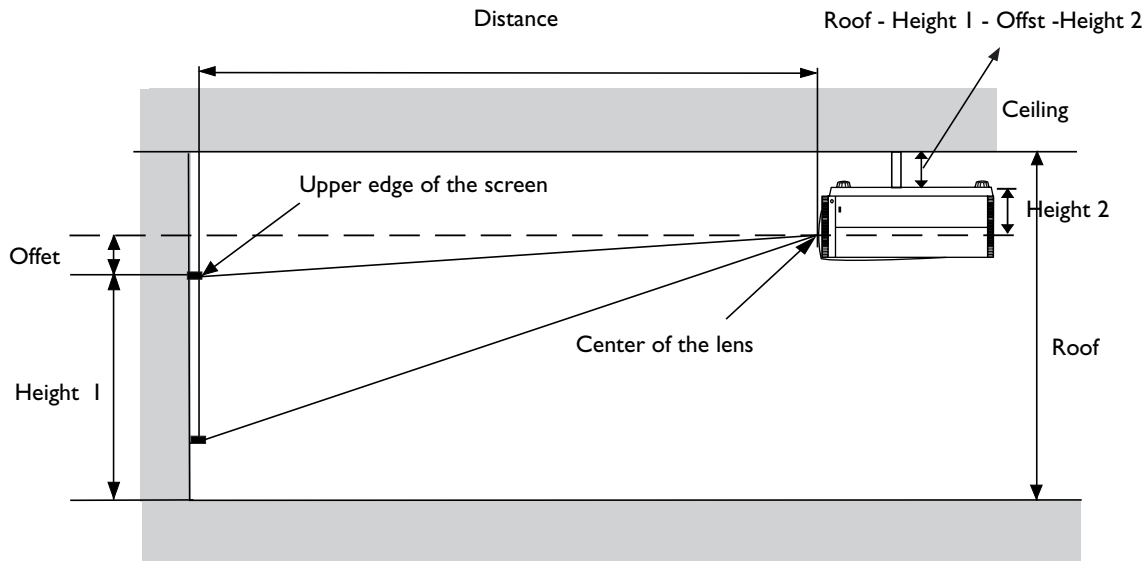

Distance: Projection distance (the distance between the projection lens and the screen).

Height 1: The vertical height of the screen upper edge

Roof: The height of the roof.

Height 2: The height from the base plate to the center of lens (2.78 inch or 70.64 mm).

Offset: The difference in height between the center of the projection lens and the upper edge of the projection image at zoom wide. (The projector should be installed horizontally.)

1. Choose the screen width you desired from the chart below, installing the projector at a distance from the screen between the corresponding Minimum and Maximum Distance. (Minimum Distance = 1.36 x Screen Width, Maximum Distance = 1.66 x Screen Width)
2. Fine tune the projected image size using the zoom and focus rings on the projection lens.
3. Decide on the exact height you desire for the center of the screen's Height.
4. Mount this unit using ceiling mounting rack with a suitable length (Roof - Height 1 - Offset - Height 2) to meet your requirements, and avoid any keystone distortion.
5. Alternatively, use the adjusters to fine tune the projection angle to meet your requirements, and then use the keystone correction function to correct any distortion.

16 : 9 (720P mode) (inch)

Screen Width (W)		40.0	60.0	80.0	90.0	100.0	110.0	120.0	130.0	140.0	160.0	180.0	200.0
Screen Height (H)		22.5	33.8	45.0	50.6	56.3	61.9	67.5	73.1	78.8	90.0	101.3	112.5
Screen Diagonal (D)		45.9	68.9	91.8	103.3	114.8	126.2	137.7	149.2	160.7	183.6	206.6	229.5
Distance	Minimum (W *1.36)	54.4	81.6	108.8	122.4	136.0	149.6	163.2	176.8	190.4	217.6	244.8	272.0
	Maximum (W *1.66)	66.4	99.6	132.8	149.4	166.0	182.6	199.2	215.8	232.4	265.6	298.8	332.0
Offset (H *1.44) (mm)		32.4	48.6	64.8	72.9	81.0	89.1	97.2	105.3	113.4	129.6	145.8	162.0

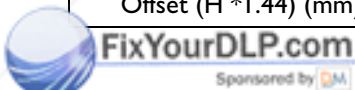

Discount-Merchant.com (800) 281-8860
THE TRUSTED SOURCE FOR PROJECTOR LAMPS AND ACCESSORIES

Floor Installation

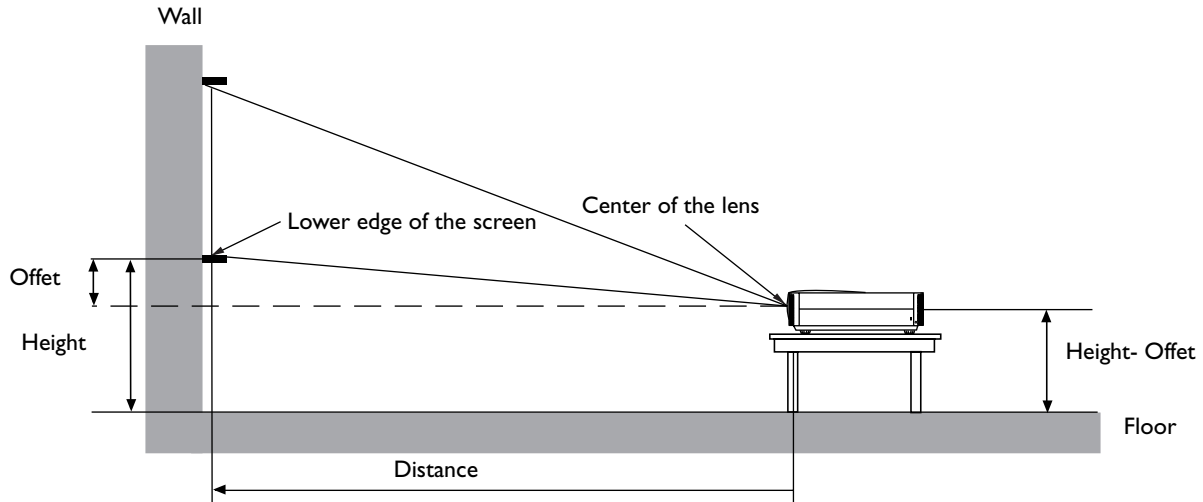

Distance : Projection distance (the distance between the projection lens and the screen.)

Height : The vertical height of the screen lower edge.

Offset : The difference in height between the center of the projection lens and the lower edge of the projection image at zoom tele. (The projector should be installed horizontally.)

1. Choose the screen width you desire from the chart below, installing the projector at a distance from the screen between the Minimum and Maximum Distance. (Minimum Distance = 1.36 x Screen Width, Maximum Distance = 1.66 x Screen Width)
2. Fine-tune the projection image size with the zoom and focus rings on the projection lens.
3. Decide on the exact height you desire for the center of the screen's Height.
4. Place the projector on a table with a suitable height (Height - Offset) to meet your requirements, to avoid any keystone distortion.
5. Alternatively, use the adjusters to fine-tune the projection angle to meet your requirements, and then use the keystone correction function to compensate for any distortion.

16:9 (720P mode) (inch)

Screen Width (W)	40.0	60.0	80.0	90.0	100.0	110.0	120.0	130.0	140.0	160.0	180.0	200.0	
Screen Height (H)	22.5	33.8	45.0	50.6	56.3	61.9	67.5	73.1	78.8	90.0	101.3	112.5	
Screen Diagonal (D)	45.9	68.9	91.8	103.3	114.8	126.2	137.7	149.2	160.7	183.6	206.6	229.5	
Distance	Minimum (W *1.36)	54.4	81.6	108.8	122.4	136.0	149.6	163.2	176.8	190.4	217.6	244.8	272.0
	Maximum (W *1.66)	66.4	99.6	132.8	149.4	166.0	182.6	199.2	215.8	232.4	265.6	298.8	332.0
Offset (H *1.44) (mm)	32.4	48.6	64.8	72.9	81.0	89.1	97.2	105.3	113.4	129.6	145.8	162.0	



Discount-Merchant.com (800) 281-8860
THE TRUSTED SOURCE FOR PROJECTOR LAMPS AND ACCESSORIES

3. Connecting

When connecting, make sure to:

1. Turn off all equipment before making any connections.
2. Use the correct signal cables for each source.
3. Ensure the cables are firmly inserted.
4. Connect all audio signals to external speakers. This projector is not equipped with speakers.

Connecting Video Inputs

■ Video/ S-Video/ Component (Interlaced Video)

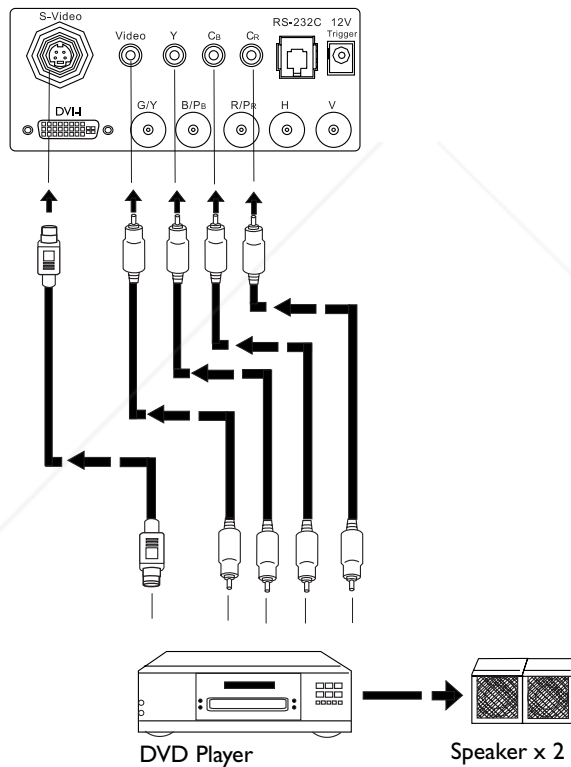

I Progressive Component (DTV Y/Pb/Pr)

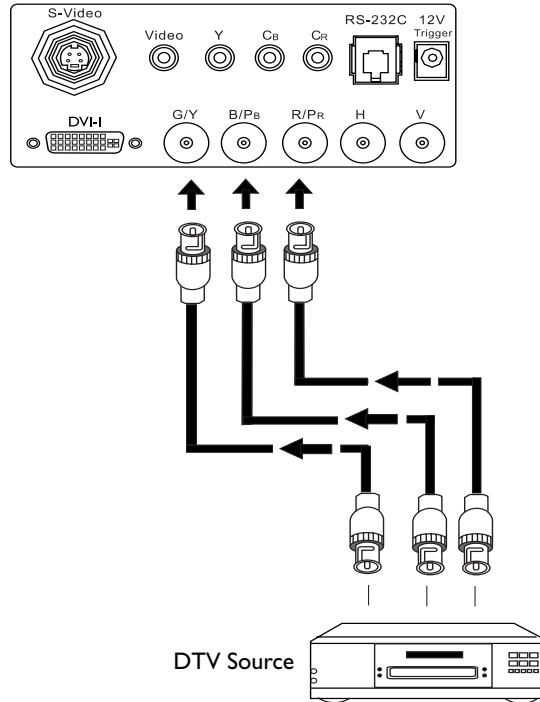

I RGBHV (DTV RGB)

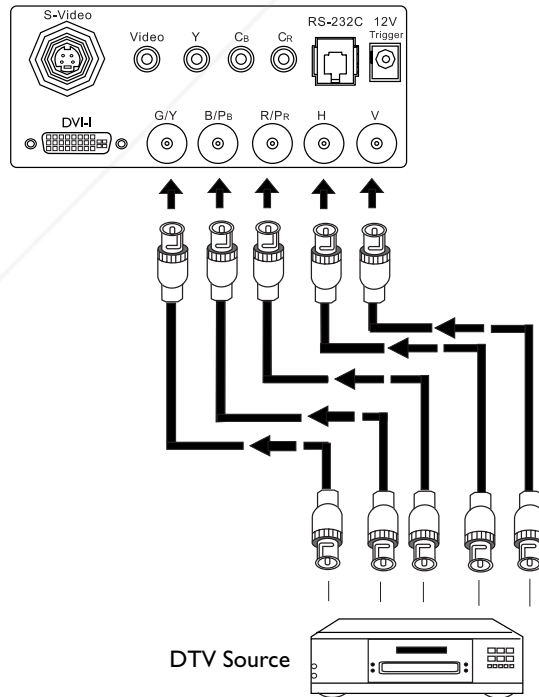

Discount-Merchant.com (800) 281-8860

The BNC input supports two HDTV formats: Progressive component (DTV Y/Pb/Pr) and DTV RGB. The projector will detect the resolution automatically.

THE TRUSTED SOURCE FOR PROJECTOR LAMPS AND ACCESSORIES

Connecting a Computer

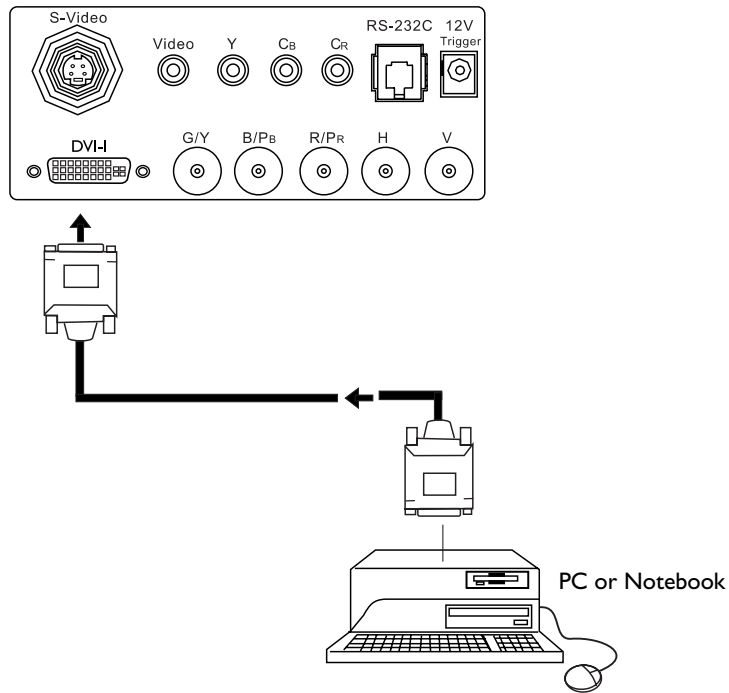

The projector only supports resolutions up to XGA. If the input signal is greater than XGA, the projector will display a warning message.

4. Basic Operation

Turning the Power on

- The Power LED shines orange when power is applied and the power switch is in the on position.
- Press and hold the ON key on the remote control or the STANDBY/ON key on the projector for ONE second to turn the projector on. The POWER LED will flash orange while warming up, then show a steady green.
- "Searching..." will be displayed on the screen before the projector identifies the input signal. This message will remain on the screen until a valid signal is detected.
- If the horizontal frequency of the input signal exceeds the range of the projector (XGA), a message reading "Not supportive timing" will be displayed on the screen. This message will remain on-screen until you change the input signal.

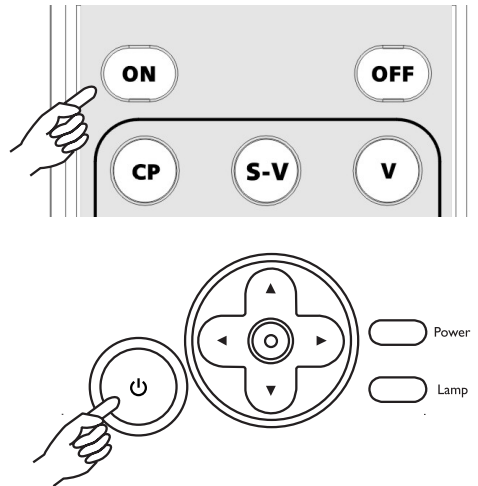

Zoom/Focusing

- Adjust the projected image size you need with the zoom ring on the lens. To focus the image, rotate the focus ring on the lens.

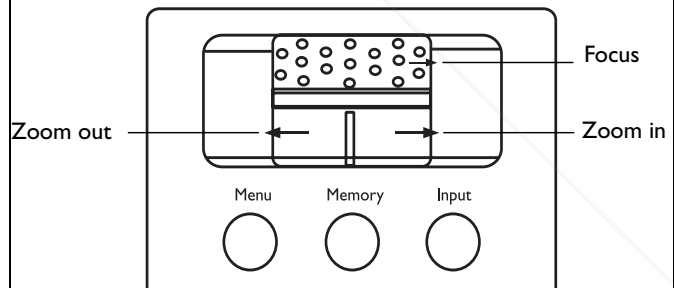

Selecting an Input Source

- When the projector is turned on, it will search for the input source you last selected.
- You may select the input source directly on the remote control.

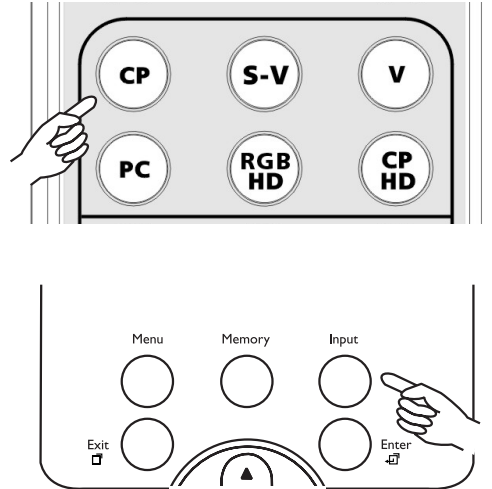

Selecting an ASPECT Ratio

- Select a proper aspect ratio according to the format of the input signal. There are five aspect ratios available:
- ANA (ANAMORPHIC): Expands an image with a 4:3 aspect ratio linearly along the horizontal axis to provide full-screen display at a 16:9 aspect ratio.
- Standard (4:3): The input signal will be scaled to accommodate a 4:3 aspect ratio display in the center of screen.
- LB (LETTERBOX): An image in letter box format is enlarged to accommodate a 16:9 aspect ratio full-screen display with the upper and lower portions cropped.
- THRO (Through): One-to-one mapping is performed on the input signal without any scaling with the image displayed at the center of the screen.
- WIDE: A 4:3 aspect ratio image is enlarged NON-linearly in horizontal direction to accommodate 16:9 full-screen display.

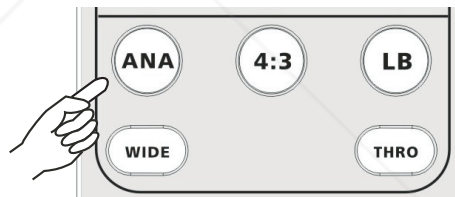

Selecting the Video Memory

- Press the video memory key on the remote control to recall the settings directly or use the MEMORY key on the projector to recall the settings sequentially.
- There are four video settings : MEMORY 1, MEMORY 2, MEMORY 3, and DEFAULT. The DEFAULT key can be used to restore the default setting for the current input source.

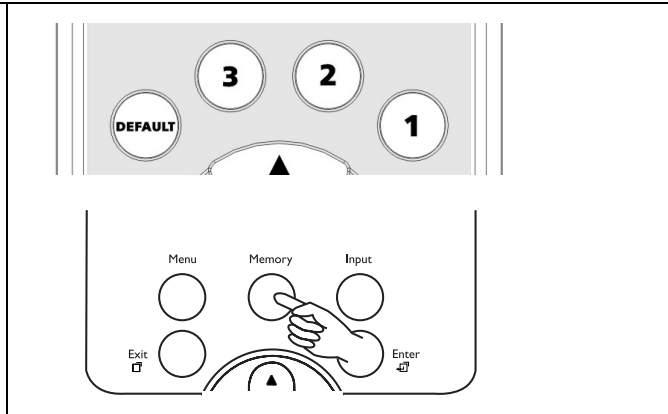

Setting Menu

- Press the MENU button to turn the on-screen display menu on or off.
- Use the ARROW buttons (▲/◀/▼/▶) to select items in the menu or to make various adjustments.
- Press the ENTER button to enter the setting for the current items in the menu, or press the EXIT button to leave and save the setting for the current items in the menu.
- For more detailed settings, see "5. Menus" on page 19.

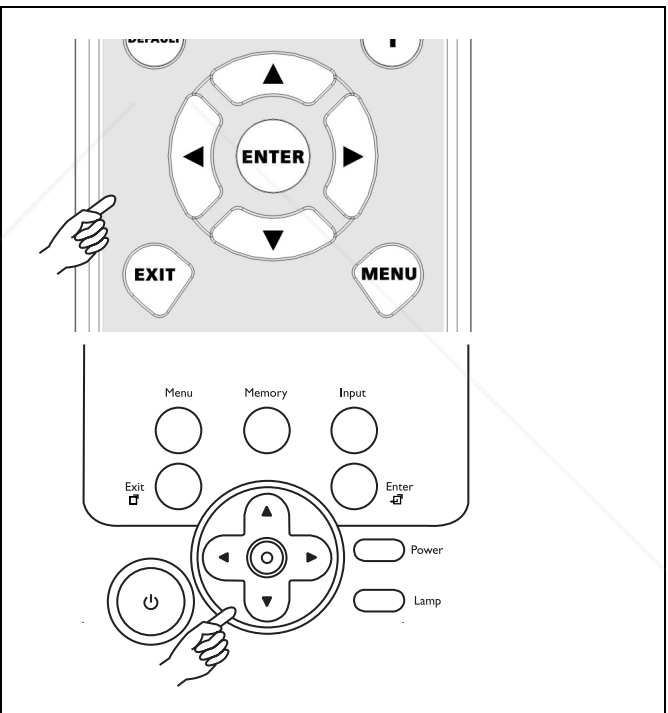

PIP (Picture-In-Picture)/POP (Picture-On-Picture) functions

- Press the PIP button to enable the PIP function.
- For PIP purposes, there are two groups of inputs classified according to their display modes:
Video Group: Video, S-Video and Component Y/Cb/Cr inputs
Graphic Group: HDTV input and Computer input.
- The PIP function allows the projector to display one input from the Graphic Group within one input from the Video Group, or display one input from Video Group within one input from the Graphic Group.
- Press the PIP button to switch to the main window or turn off the PIP function.
- Select the input source for the main window by pressing the INPUT button.
- Press the POP key to enable the POP function.
- Press the ACTIVE button to switch to the active window. You can change the input signal setting in the active window.
- Press + or - to adjust the size of the PIP window.
- Adjust the position of the PIP window with the ARROW keys (▲/◀/▼/▶).

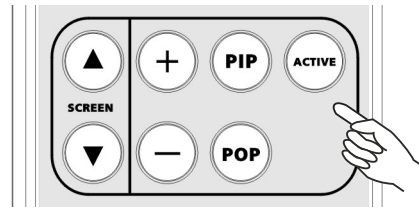

Turning the Projector Off

- Press the OFF key on the remote control or the STANDBY/ON key on the projector to turn the projector off.
- After turning the projector off, the POWER LED will flash green and the fans will run for one minute to cool the lamp. The projector will not respond to any commands until cooling process is complete. The POWER LED will be lit a steady orange once the cooling process has finished.

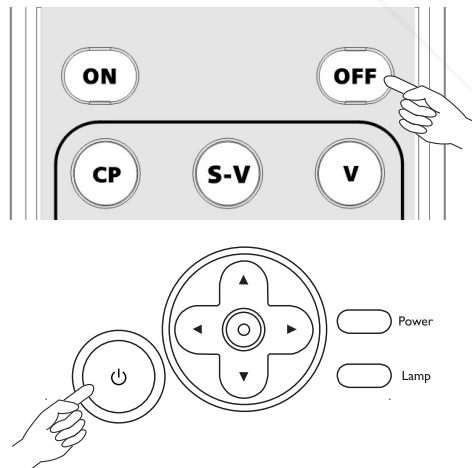

5. Menus

Using the Menus

The projector is equipped with on-screen display (OSD) menus for making various adjustments and settings.

There are eight different menu languages. Refer to “Language setting” on page 22 for more details.

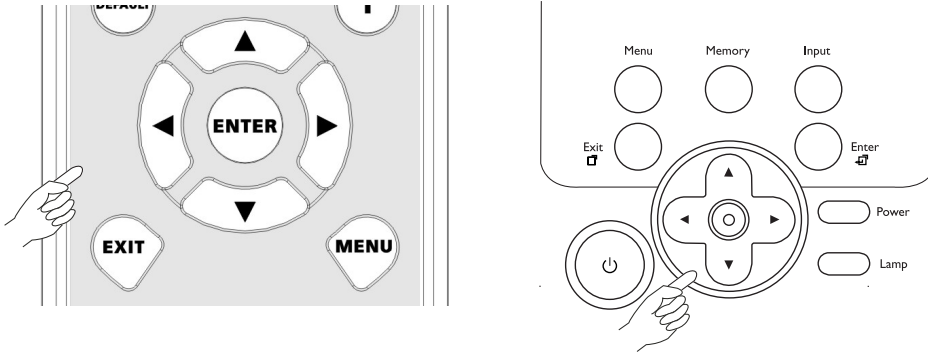

- Press the MENU button to turn the on-screen display menu function on or off.
- Use the ARROW buttons (▲/◀/▼/▶) to select items in the current menu or to make various adjustments.
- Press the ENTER button to enter the setting of the current item in the menu, or press the EXIT button to leave and save settings for items shown in the menus. There are four main menus available.



PICTURE Menu

In this menu, all 'front panel' adjustments can be made. These settings can be stored in three separate video memories, in which each can have different parameters for different input sources.

There are eleven items in this menu: BRIGHTNESS — CONTRAST — COLOR — SHARPNESS — TINT — COLOR TEMP. — FILTERS — RED — GREEN — BLUE — YELLOW.



1. BRIGHTNESS: Adjusts the picture brightness to values between 0 and 60. The higher the value, the brighter the picture. And lower the setting, darker the picture.
2. CONTRAST: Adjusts the picture contrast to values between 0 and 30. The higher the value, the greater the contrast.

3. **COLOR:** Adjusts the color intensity to values between 0 and 60. The higher the value, the more intense the color.
4. **SHARPNESS:** Adjusts the picture sharpness to values between -10 and +10. The higher the value, the sharper the picture.
5. **TINT:** Adjusts the color tones to values between 0 and 30. The higher the value, the more green-toned the picture becomes. The lower the value, the more purplish the picture becomes.
6. **COLOR TEMP:** Adjusts the color temperature.
 - 0 : The default color temperature of the lamp.
 - 1 : Low color temperature (6500°K). Makes white appear reddish.
 - 2 : Middle color temperature (7500°K). Maintains normal colorings for white.
 - 3 : High color temperature (9300°K). Makes white bluish.
7. **FILTERS:** Turn the video filters on or off. Filters can reduce noise in the picture to produce a sharper image. There are four filters for video input (0 ~ 3) and two filters for graphic input (0 ~ 1). The higher the setting, the less the noise.
8. **RED:** Adjusts red hues independently to values between 0 and 30. The higher the setting, the greater the intensity of red hues.
9. **GREEN:** Adjusts green hues independently to values between 0 and 30. The higher the setting, the greater the intensity of green hues.
10. **BLUE:** Adjusts blue hues independently to values between 0 and 30. The higher the setting, the greater the intensity of blue hues.
11. **YELLOW:** Adjusts yellow hues independently to values between 0 and 30. The higher the setting, the greater the intensity of yellow hues.

DISPLAY Menu

In this menu, you can set the way the projector displays the picture.

There are five items in this menu: SOURCE — ASPECT — PC&HDTV — SAVE — LOAD.

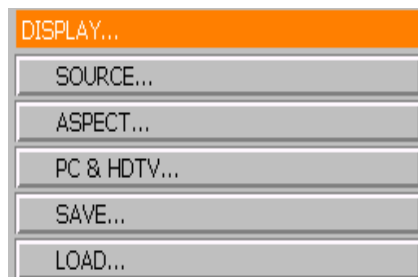

 FixYourDLP.com

- SOURCE: Selects the input source.
- VIDEO: Composite video signal input.
- S-VIDEO: S-Video signal input.
- COMPONENT: Component Y/Cb/Cr input
- COMP - HD: DTV Y/Pb/Pr input
- RGB - HD: DTV RGBHV signal input

Discount-Merchant.com (800) 281-8860
THE TRUSTED SOURCE FOR PROJECTOR LAMPS AND ACCESSORIES

- DVI-I: Computer signal input PC. Auto select DVI-A (Analog) or DVI-D (Digital) signal.
2. ASPECT: There are five aspect ratios that can be selected for video signal inputs:
- ANAMORPHIC: Expands an image with a 4:3 aspect ratio linearly along the horizontal axis to provide full screen display at a 16:9 aspect ratio.

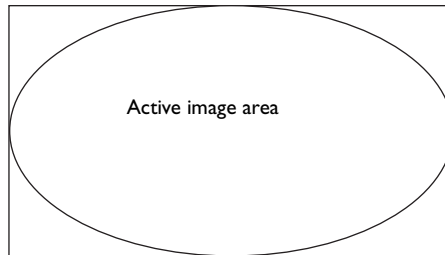

- STANDARD (4:3): Scales an input image so that it is displayed with a 4:3 aspect ratio display mode in the center of the screen which you have set in the INSTALLATION menu.

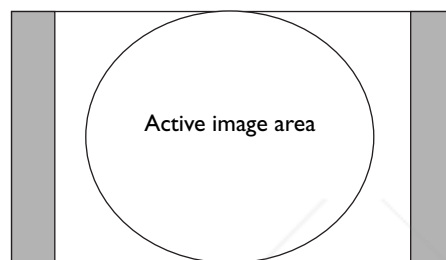

16 : 9 screen

- LETTERBOX: Enlarges an image in letter box format to display in full-screen format with a 16:9 aspect ratio, with upper and lower portions cropped.

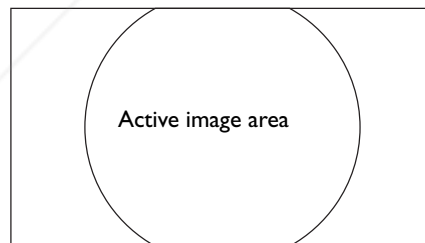

- WIDE: Expands an image with a 4:3 aspect ratio NON-linearly along the horizontal axis to provide full screen display at a 16:9 aspect ratio.

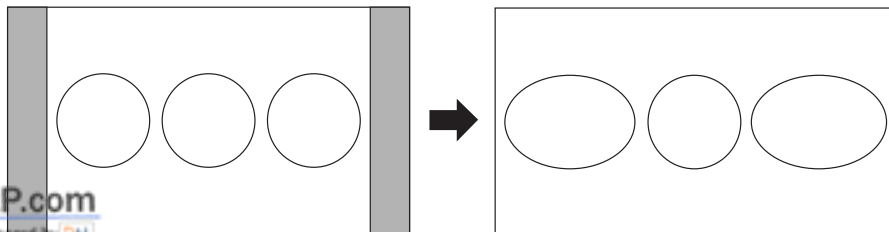

- **THROUGH** : One-to-one mapping is performed without any scaling of the image, The image is displayed at the center of the screen.

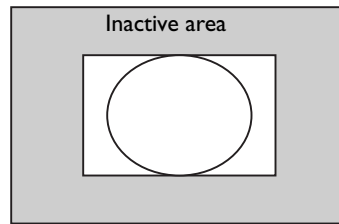

3. **PC&HDTV**: The following settings are only available with a PC or DTV RGB signal:
 - **AUTO**: Adjusts the phase, frequency and position automatically.
 - **FREQ.**: Adjusts the frequency of the input signal.
 - **PHASE**: Adjusts the phase of the input signal.
 - **H. POS.**: Adjusts the horizontal position of the image.
 - **V. POS.**: Adjusts the vertical position of image.
4. **SAVE**: There are three video memories in which the user can store settings, including all items in the Picture menu.
5. **LOAD**: Loads the settings from one of three video memories.

ENVIRONMENT Menu

In this menu, global settings for the projector can be made.

There are four items available: **DEFAULT** — **LAMP TIMER** — **AUTO OFF** — **LAMP HOURS**.

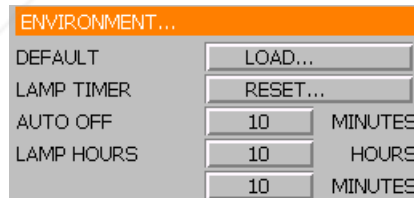

1. **DEFAULT**: Loads the default value of the current input source.
2. **LAMP TIMER**: Resets the lamp timer. This should only be done after the lamp has been replaced.
3. **AUTO OFF**: Sets the auto-shutdown timer. The timer can be set to a value between 10 minutes and 3 hours.
4. **LAMP HOURS**: This displays the number of hours the lamp has been used. (The lifetime of the lamp is 2000 hours.) If lamp usage exceeds 2000 hours, a warning message will be displayed on-screen; when this happens, contact your BenQ dealer for a new lamp.

INSTALLATION Menu

THE TRUSTED SOURCE FOR PROJECTOR LAMPS AND ACCESSORIES

This menu contains items necessary for installation.



There are five items available: LANGUAGE, MIRROR, KEYSTONE, SCREEN and PATTERN.





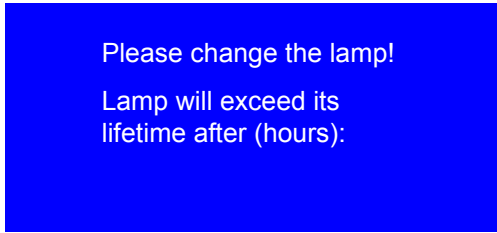

1. **LANGUAGE:** There are eight languages that can be selected for the menus: English, French, Spanish, German, Italian, Traditional Chinese, Simplified Chinese and Korean.
2. **MIRROR:** The projector can be installed on a ceiling or behind a screen, or with one or more mirrors. There are four settings:
 - FLOOR FRONT
 - CEILING FRONT
 - FLOOR REAR
 - CEILING REAR
3. **KEYSTONE:** Corrects for trapezoidal distortion resulting from the angle of projection. It can provide correction up to ± 12 degrees of offset.
4. **OSD POSITION:** OSD POSITION can be adjusted between 0 and 100 degrees in both vertical and horizontal directions.
5. **BACKGROUND:** Selects a proper background color for your screen when there is no input signal.
6. **PATTERN:** One test pattern (an 8 x 8 grid) will be displayed when you select this menu item. It will be displayed with the aspect ratio depending on ASPECT setting made in the DISPLAY menu. When installing the projector, you can use this test pattern even when there is no actual input signal.

6. Additional Information

Warning Message

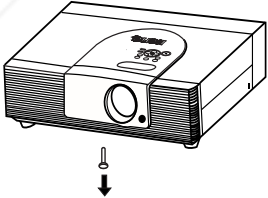
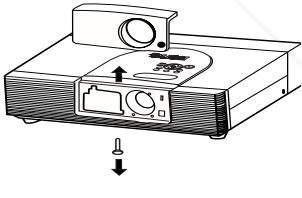
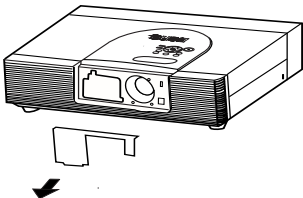
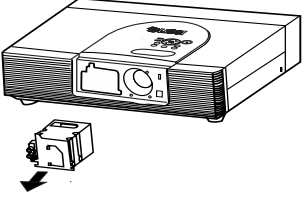
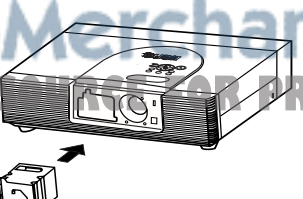
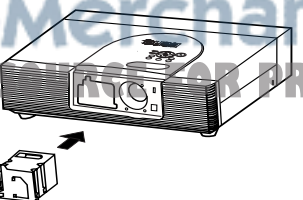
<ul style="list-style-type: none"> ■ It is normal for illumination from the lamp to dim somewhat when the projector has been used for a period of time. ■ The message "Lamp life is expired ! Please change a new lamp. And reset the lamp timer." will be displayed for 30 seconds on the screen when the lamp has been in use for 1950 hours. 	
<ul style="list-style-type: none"> ■ The message " Please change the lamp, Lamp will exceed its lifetime after (hours): " will be displayed on the screen for 30 seconds each time the projector is turned on after the lamp has been in use for 1980 hours. The number of hours will be updated. 	
<ul style="list-style-type: none"> ■ The message " Please change the lamp ! " will be displayed on the screen continuously and the POWER LED will flash orange and green sequentially if the lamp has been in use for more than 2,000 hours. ■ The projector will turn off automatically after 10 minutes. 	

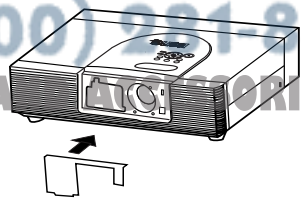
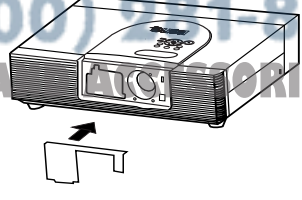
Replace the Lamp

<p>1. Loosen the screws on the front lamp cover.</p> 	<p>2. Remove the front lamp cover.</p> 
<p>3. Loosen the three screws on the lamp shield.</p> 	<p>5. Loosen the two screws on the lamp module.</p> 
<p>4. Take off the lamp shield.</p>  <p>7. Insert the new lamp module into the projector horizontally until it is securely in place.</p>  <p>8. Tighten the two screws on the lamp module.</p> 	<p>6. Pull out the lamp module horizontally.</p>  <p>9. Put on the lamp shield.</p>  <p>10. Tighten the three screws on the lamp shield.</p> 

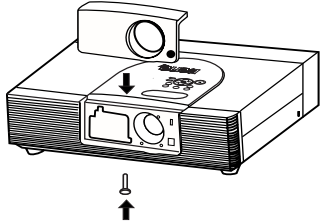
<p>11. Put on the front lamp cover.</p> <p>12. Tighten the screws on front lamp cover.</p>		<p>13. Turn the power on and go into Environment menu to reset the "Lamp Timer" item.</p>
--	---	---

Troubleshooting

Problem	Cause	Remedy
This projector does not turn on.	There is no power from the power cable.	Plug the power cord into the AC inlet on the rear of the projector, and plug the power cord into to the power outlet.
	The power switch is not in the on position.	Put the power switch in the on position.
	Turn the projector on again during the cooling process.	Wait this unit complete the cooling down procedure.
	Front lamp cover is not attached well.	Correctly attach the front lamp cover.
No picture.	The front lamp cover has not been attached securely.	Correctly attach the front lamp cover.
	The projector is not correctly connected to the input source device.	Check the connection.
	The input signal has not been correctly selected.	Selects the correct input signal with the INPUT key on the remote control unit.
	The input signal has not been correctly selected in the "INPUT SOURCE" item in the DISPLAY menu.	Select the correct input signal.
	POWER LED or LAMP LED flashing.	Please contact your BenQ dealer for assistance.
Image is unstable.	The connection cables are not connected to this unit.	Correctly connect the cables to the appropriate terminals.
Picture is blurred.	The projection lens is not correctly focused.	Adjust the focus of projection lens with the focus ring.
	The projector and the screen are not aligned properly.	Adjust the projection angle and direction as well as the height of this unit if necessary.
Remote control does not work correctly	The batteries are out of power.	Replace both batteries with new ones.
LAMP LED flashes red	The front lamp cover is not correctly attached.	Correctly attach the front lamp cover.
	The cooling fan is not working properly.	Please contact your BenQ dealer for assistance.
	The temperature inside the projector is extremely high.	Check that the ventilation holes are not blocked.
POWER LED flashed orange and green sequentially.	The lamp has exceeded its specified usage time.	Replace the lamp with a new one.
	The lamp has burned out.	Replace the lamp with a new one.

Specifications

Optical Characteristics

Projection system	Single-chip DLP™ system.
DMD chip	HD2 DMD, 1280 x 720 pixels.
Lens	1.2-times zoom ratio, F/# 2.8, efl 24.2; F/# 3.42, efl 29.6
Focus distance	1.5m to 5m
Projection size	40 to 250 inches
Lamp	210W NSH

Electrical Characteristics

Color system	NTSC3.58 — NTSC 4.43 — SECAM and PAL-M / PAL-N
Resolution	720 Horizontal TV lines (16:9) 1280 x 720 (RGB input)

Input/Output

Video (RCA Jack)	Composite video, 1 Vp-p ± 2 dB sync negative (75 ohms terminated)
S-Video (mini DIN 4-pin)	Y (luminance), 1 Vp-p ± 2 dB sync negative (75 ohms terminated) C (chrominance), burst 0.286 Vp-p ± 2 dB (NTSC) (75 ohms terminated), burst 0.3 Vp-p ± 2 dB (PAL) (75 ohms terminated)
Component (RCA Jacks)	Y (luminance), 1 Vp-p ± 2 dB sync negative (75 ohms terminated) CB : 0.7 Vp-p ± 2 dB CR : 0.7 Vp-p ± 2 dB

RGB/ HDTV (BNC)

G with sync / Y : 1 Vp-p ± 2 dB sync negative (75 ohms terminated)
B/PB : 0.7 Vp-p ± 2 dB
R/PR : 0.7 Vp-p ± 2 dB
H (horizontal sync): 1-5 Vp-p high impedance, positive/negative
V (vertical sync): 1-5 Vp-p high impedance, positive/ negative

Computer (DVI-I)

RS-232C (mini-DIN 8-pin)

12v Trigger (mini-jack)	Power On DC12V
--------------------------------	----------------

General Characteristics

Dimensions	400mm x 347mm x 116mm (L x W x H)
Weight	16.7 lbs (7581 g)
Power	VAC 100 - 240 Full-range switch (50/60Hz), 3 Wire Grounded
Power consumption	Max 310 W
Operating temperature	10°C to 35°C
Operating humidity	20% - 90%
Storage temperature	-10°C - 70°C
Storage humidity	20% - 90%



Discount-Merchant.com (800) 281-8860
THE TRUSTED SOURCE FOR PROJECTOR LAMPS AND ACCESSORIES

Dimensions

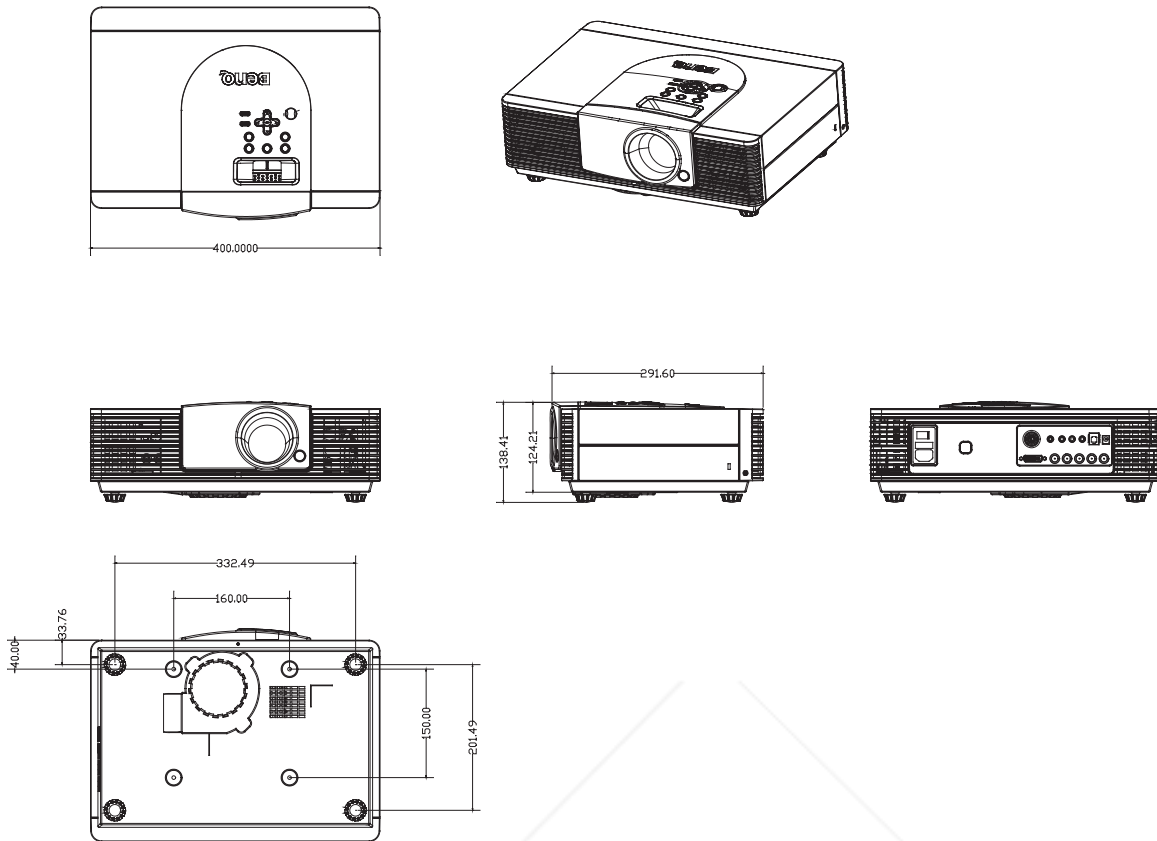

Unit: mm



Disclaimer

This user manual is provided as a free service by FixYourDLP.com. FixYourDLP is in no way responsible for the content of this manual, nor do we guarantee its accuracy. FixYourDLP does not make any claim of copyright and all copyrights remain the property of their respective owners.

About FixYourDLP.com

FixYourDLP.com (<http://www.fixyourdpl.com>) is the World's #1 resource for media product news, reviews, do-it-yourself guides, and manuals.

Informational Blog: <http://www.fixyourdpl.com>

Video Guides: <http://www.fixyourdpl.com/guides>

User Forums: <http://www.fixyourdpl.com/forum>

FixYourDLP's Fight Against Counterfeit Lamps:

<http://www.fixyourdpl.com/counterfeits>

Sponsors:

RecycleYourLamp.org – Free lamp recycling services for used lamps:

<http://www.recycleyourlamp.org>

Lamp Research - The trusted 3rd party lamp research company:

<http://www.lampresearch.com>

Discount-Merchant.com – The worlds largest lamp distributor:

<http://www.discount-merchant.com>



FixYourDLP.com

Sponsored by 