



Disclaimer

This user manual is provided as a free service by FixYourDLP.com. FixYourDLP is in no way responsible for the content of this manual, nor do we guarantee its accuracy. FixYourDLP does not make any claim of copyright and all copyrights remain the property of their respective owners.

About FixYourDLP.com

FixYourDLP.com (<http://www.fixyourdpl.com>) is the World's #1 resource for media product news, reviews, do-it-yourself guides, and manuals.

Informational Blog: <http://www.fixyourdpl.com>

Video Guides: <http://www.fixyourdpl.com/guides>

User Forums: <http://www.fixyourdpl.com/forum>

FixYourDLP's Fight Against Counterfeit Lamps:

<http://www.fixyourdpl.com/counterfeits>

Sponsors:

RecycleYourLamp.org – Free lamp recycling services for used lamps:

<http://www.recycleyourlamp.org>

Lamp Research - The trusted 3rd party lamp research company:

<http://www.lampresearch.com>

Discount-Merchant.com – The worlds largest lamp distributor:

<http://www.discount-merchant.com>



FixYourDLP.com

Sponsored by 

BenQ

MP720 Digital Projector
Mainstream Series
User's Manual

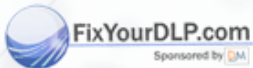

Discount-Merchant.com (800) 281-8860

THE TRUSTED SOURCE FOR PROJECTOR LAMPS AND ACCESSORIES

Welcome

Copyright

Copyright 2005 by BenQ Corporation. All rights reserved. No part of this publication may be reproduced, transmitted, transcribed, stored in a retrieval system or translated into any language or computer language, in any form or by any means, electronic, mechanical, magnetic, optical, chemical, manual or otherwise, without the prior written permission of BenQ Corporation.

Disclaimer

BenQ Corporation makes no representations or warranties, either expressed or implied, with respect to the contents hereof and specifically disclaims any warranties, merchantability or fitness for any particular purpose. Further, BenQ Corporation reserves the right to revise this publication and to make changes from time to time in the contents hereof without obligation to notify any person of such revision or changes.

*DLP, Digital Micromirror Device and DMD are trademarks of Texas Instruments. Others are copyrights of their respective companies or organizations.

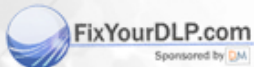

Discount-Merchant.com (800) 281-8860
THE TRUSTED SOURCE FOR PROJECTOR LAMPS AND ACCESSORIES

Table of contents

Important safety instructions	1
Introduction	5
Projector features	5
Shipping contents	6
Optional accessories	6
Projector exterior view	7
Front / upper side	7
Rear side	7
Side view	8
Lower side	8
Controls and functions	9
External control panel	9
Remote control	10
Remote control effective range	12
Replacing the remote control battery	12
Positioning your projector	13
Choosing a location	13
Obtaining a preferred projected image size	15
How to determine the position of the projector for a given screen size: ..	16
How to determine the recommended screen size for a given distance:	16
Connection	18
Wireless connection (optional)	18
Cable connection	18
Connecting a computer or monitor	18
Connecting Video source devices	21
Operation	25
Start up	25
Utilizing the password function	25
To set a password:	26
If you forget the password:	26
To enter the password recall procedure:	26
To change the password:	26
Adjusting the height	27
Auto-adjusting the image	27
Fine-tuning the image size and clarity	28



DiscountMerchants.com (800) 231-3660
THE TRUSTED SOURCE FOR PROJECTOR LAMPS AND ACCESSORIES

Correcting keystone	28
Selecting an application mode.....	29
Switching input signal	29
Hiding the image	29
Remote paging operations.....	30
Freezing the image	30
Shutdown	30
Menu operation	31
Menu system	31
Using the menus	32
1. Picture menu	33
2. Pro-Picture menu	35
3. Setting menu	36
4. Advance menu	37
5. Information menu.....	39
Maintenance	40
Care of the projector	40
Cleaning the lens	40
Cleaning the projector case	40
Storing the projector	40
Transporting the projector	40
Cleaning and replacing the dust filter	40
Lamp information.....	43
Calculation of lamp hour	43
Warning message	43
Replacing the lamp.....	44
Temperature information	46
Indicators.....	47
Safety instructions for ceiling mounting of your BenQ projector.....	49
Troubleshooting.....	50
Specifications.....	51
Projector specifications	51
Timing chart.....	52
Supported timing for PC input	52
Supported timing for Component-YPbPr input	52
Supported timing for Video and S-Video inputs	52
Dimensions	53
Warranty.....	54
Limited Warranty	54



FixYourDLR.com
Sponsored by DLR

Discourse Merchant.com (800) 281-860
THE TRUSTED SOURCE FOR PROJECTOR LAMPS AND ACCESSORIES

Regulation Statements	55
FCC statement	55
EEC statement	55
MIC statement	55
WEEE directive	55



Discount-Merchant.com (800) 281-8860
THE TRUSTED SOURCE FOR PROJECTOR LAMPS AND ACCESSORIES

<Memo>

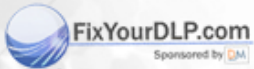

Discount-Merchant.com (800) 281-8860
THE TRUSTED SOURCE FOR PROJECTOR LAMPS AND ACCESSORIES

1 Important safety instructions

Your BenQ projector is designed and tested to meet the latest standards for safety of information technology equipment. However, to ensure safe use of this product, it is important that you follow the instructions mentioned in this manual and marked on the product.

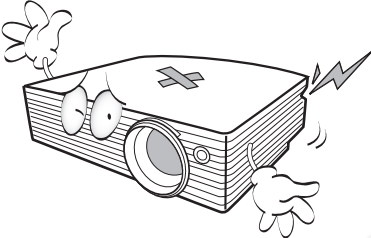
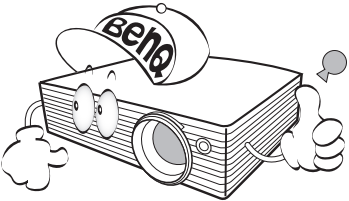
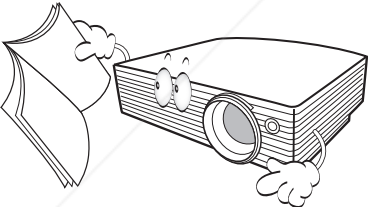
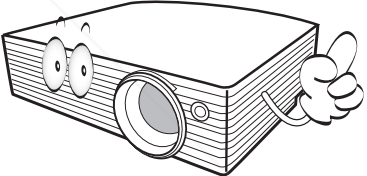
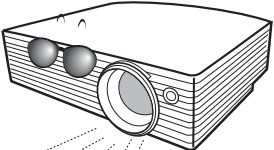
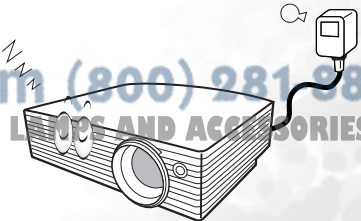
Caution	
<ul style="list-style-type: none">• To prevent shock, do not open the cabinet. There are no user serviceable parts inside. 	<ul style="list-style-type: none">• Refer servicing to qualified service personnel. 
<ul style="list-style-type: none">• Please read this user's manual before you operate your projector. Save this user's manual for future reference. 	<ul style="list-style-type: none">• Always open the lens shutter or remove the lens cap when the projector lamp is on. 
<ul style="list-style-type: none">• Do not look straight at the projector lens during operation. The intense light beam may damage your eyes. 	<ul style="list-style-type: none">• In some countries, the line voltage is NOT stable. This projector is designed to operate safely within a mains voltage between 100 to 240 volts AC, but could fail if power cuts or surges of ± 10 volts occur. In areas where the mains voltage may fluctuate or cut out, it is recommended that you connect your projector through a power stabilizer, surge protector or uninterruptible power supply (UPS). 

FixYourDLP.com
Sponsored by DM

DiscountMerchant.com (800) 281-9860
THE TRUSTED SOURCE FOR PROJECTOR LENSES AND ACCESSORIES

Safety Instructions

1. The lamp becomes extremely hot during operation. Allow the projector to cool for approximately 45 minutes prior to removing the lamp assembly for replacement.

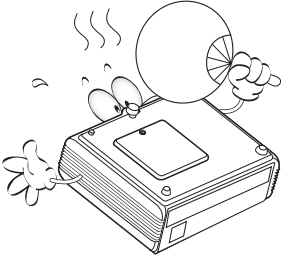

2. Do not operate lamps beyond the rated lamp life. Excessive operation of lamps beyond the rated life could cause them to break on rare occasions.

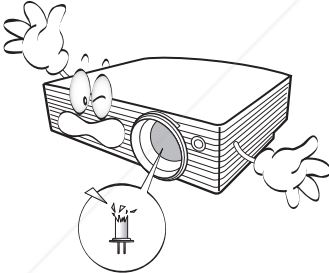

3. Never replace the lamp assembly or any electronic components unless the projector is unplugged.

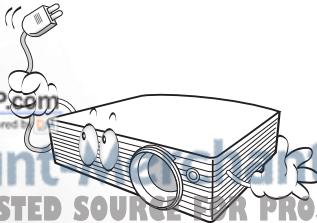

4. Do not place this product on an unstable cart, stand, or table. The product may fall, sustaining serious damage.

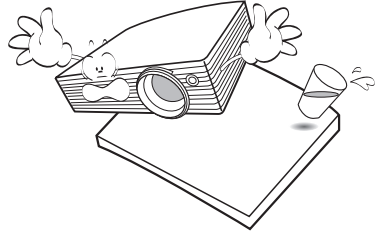

5. To reduce the risk of electric shock, do not disassemble this appliance. Take it to a qualified technician when service or repair is required. Incorrect reassembly can cause malfunction of the projector or electric shock when the appliance is subsequently used.

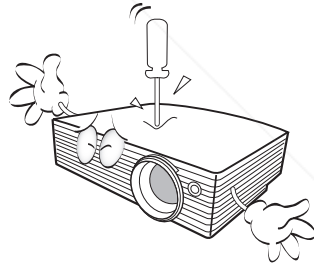

Safety Instructions (Continued)

6. Do not place this projector in any of the following environments.

- Space that is poorly ventilated or confined. Allow at least 50 cm clearance from walls and free flow of air around the projector.
- Locations where temperatures may become excessively high, such as the inside of a car with all windows rolled up.
- Locations where excessive humidity, dust, or cigarette smoke may contaminate optical components, shortening the projector's life span and darkening the image.

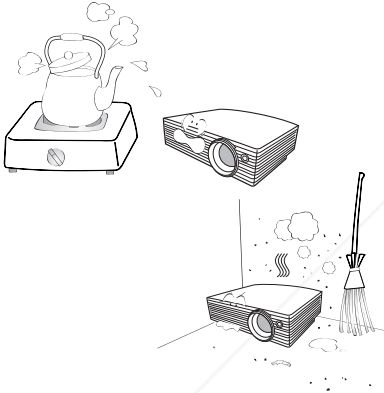

- Locations near fire alarms
- Locations with an ambient temperature above 40°C / 104°F
- Locations where the altitudes are higher than 10000 feet.

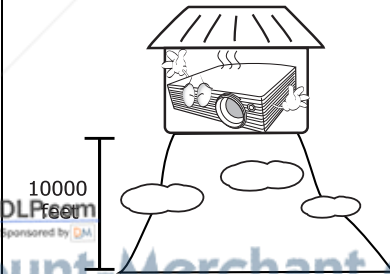

7. Do not block the ventilation holes.

- Do not place this unit on a blanket, bedding or any other soft surface.
- Do not cover this unit with a cloth or any other item.
- Do not place inflammables near the projector.

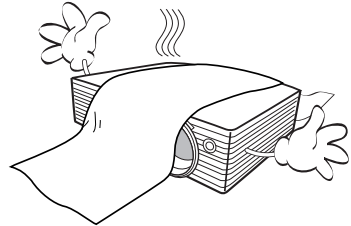

If the ventilation holes are seriously obstructed, overheating inside the unit may result in a fire.

8. Always place the unit on a level, horizontal surface during operation.

- Do not use if tilted at an angle of more than 10 degrees left to right, nor at angle of more than 15 degrees front to back. Using the unit when it is not fully horizontal may cause a malfunction of, or damage to, the lamp.

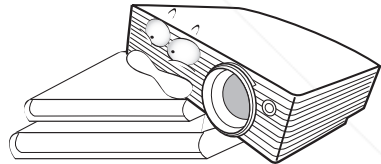

9. Do not stand the unit on end vertically. Doing so may cause the unit to fall over, causing injury or resulting in damage to the unit.

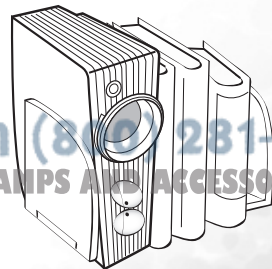

Safety Instructions (Continued)

10. Do not step on the projector or place any objects upon it. Besides probable physical damage to the projector, doing so may result in accidents and possible injury.



11. Do not block the projection lens with any objects when the projector is under operation as this could cause the objects to become heated and deformed or even cause a fire. To temporarily turn off the lamp, press **Blank** on the projector or remote control.

12. Do not place liquids near or on the projector. Liquids spilled into the projector may cause it to fail. If the projector does become wet, disconnect it from the power supply's wall socket and call BenQ to have the projector serviced.

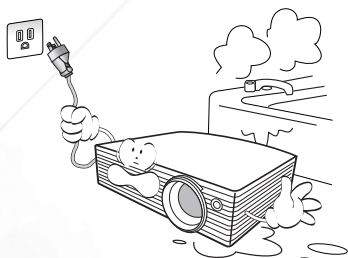

13. This product is capable of displaying inverted images for ceiling mount installation.



Please use BenQ's Ceiling Mount Kit for mounting the unit and ensure it is securely installed.

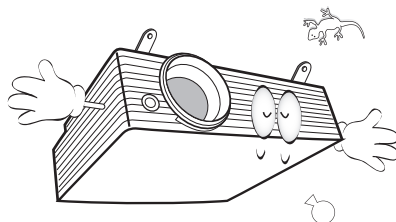

14. When the projector is under operation, you may sense some heated air and odor from its ventilation grill. It is a normal phenomenon and not a product defect.

2 Introduction

Projector features

The projector integrates high-performance optical engine projection and a user-friendly design to deliver high reliability and ease of use.

The projector offers the following features:

- Selectable password protected function
 - Selectable quick cooling function for reducing projector cooling time
 - Optional wireless module allowing more computers to share one projector through cable or wireless connection
 - Compact and portable unit
 - High quality manual zoom lens
 - One-key auto-adjustment to display the best picture quality
 - Digital keystone correction to correct distorted images
 - Adjustable color balance control for data/video display
 - Ultra-high brightness projection lamp
 - Ability to display 16.7 million colors
 - Multi-language on-screen menus
 - Switchable normal and Economic modes to reduce the power consumption
 - Built-in speaker provides mixed mono audio when an audio input is connected
 - Powerful AV function to provide high quality AV picture
 - Component HDTV compatibility (YPbPr)
-  • **The apparent brightness of the projected image will vary depending on the ambient lighting conditions, selected input source contrast/brightness settings, and is directly proportional to projection distance.**
- **The lamp brightness will decline over time and may vary within the lamp manufacturers specifications. This is normal and expected behavior.**



Discount-Merchant.com (800) 281-8860
THE TRUSTED SOURCE FOR PROJECTOR LAMPS AND ACCESSORIES

Shipping contents

The projector is shipped with the cables required for connection to a PC. Carefully unpack and verify that you have all of the items shown below. If any of these items are missing, please contact your place of purchase.

 **The supplied accessories will be suitable for your region, and may differ from those illustrated.**

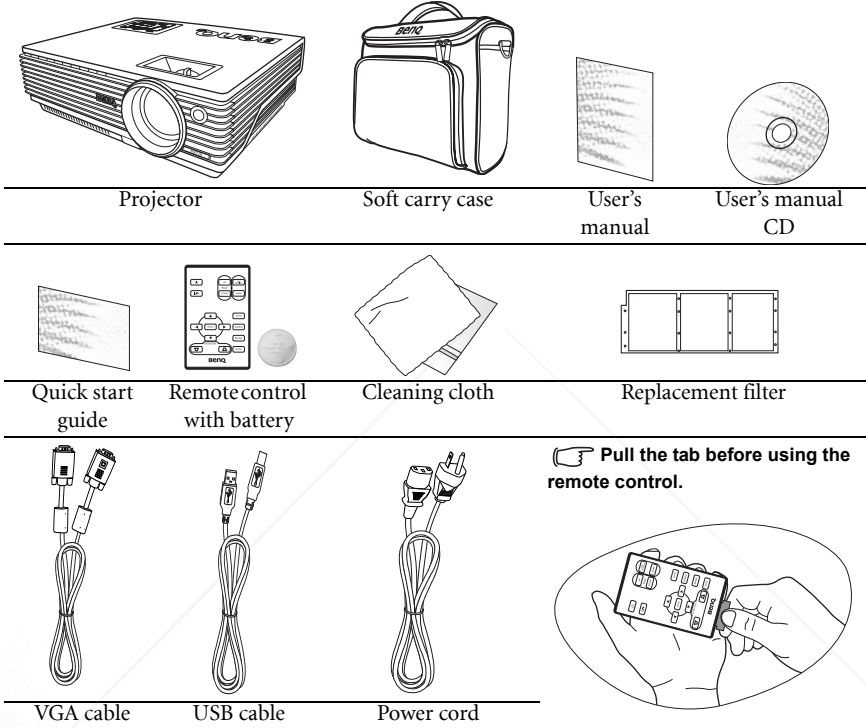

Optional accessories

1. Macintosh adapter
2. 230W lamp module
3. Ceiling mount kit
4. Component Video to VGA (D-sub) adaptor cable
5. RS232 connector
6. Wireless module

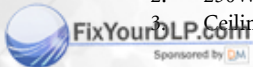

Discount-Merchant.com (800) 281-8860
THE TRUSTED SOURCE FOR PROJECTOR LAMPS AND ACCESSORIES

Projector exterior view

Front / upper side

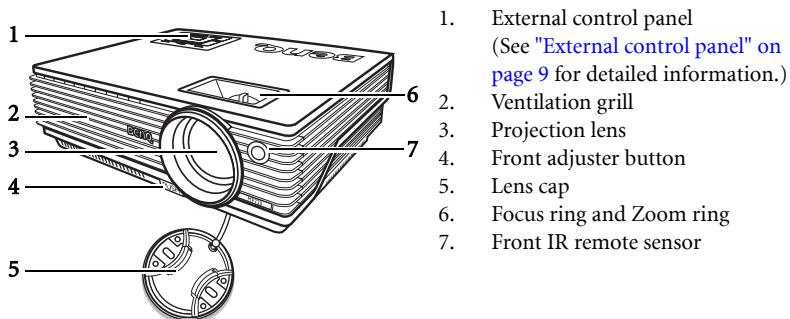

Rear side

Refer to "[Connection](#)" on page 18 for more information on making connections to various equipment.

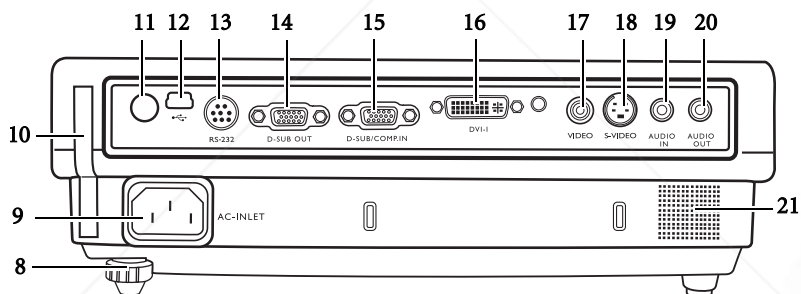

- | | |
|------------------------------|---|
| 8. Rear adjuster foot | 15. RGB (PC) / Component video (YPbPr/ YCbCr) signal input socket |
| 9. AC power cord inlet | 16. DVI-I signal input socket |
| 10. Filter case | 17. Video socket |
| 11. Rear IR remote sensor | 18. S-Video socket |
| 12. USB socket | 19. Audio input socket |
| 13. RS232 control port | 20. Audio output socket |
| 14. RGB signal output socket | 21. Speaker |

Side view

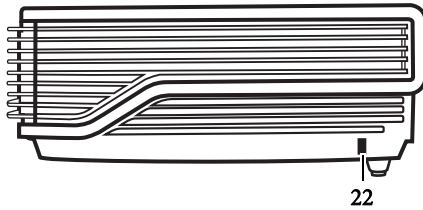

22. Kensington anti-theft lock slot

Lower side

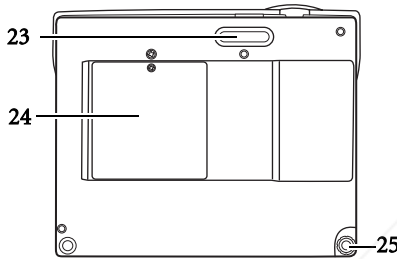

23. Front adjuster foot

24. Lamp cover

25. Rear adjuster foot

Controls and functions

External control panel

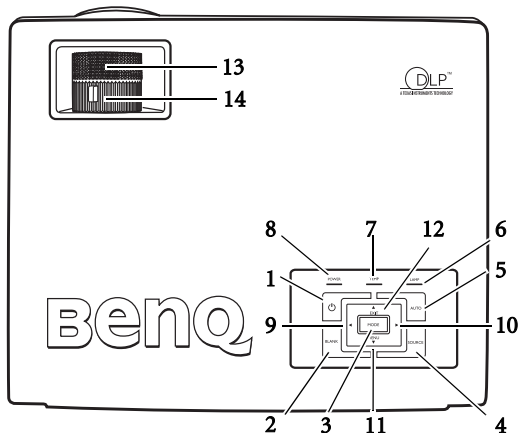

1. **Power** (Refer to ["Start up" on page 25](#) and ["Shutdown" on page 30](#) for more information.)
Turns the projector on or off.
2. **Blank** (Refer to ["Hiding the image" on page 29](#) for more information.)
Used to hide the screen image. You can press any key on the control panel to bring the image back.
3. **Mode** (Refer to ["Application Mode" on page 33](#) for more information.)
Depending upon which input signal is selected, there are several picture setup options available.
When a wireless module is installed and the Wireless Connection menu is displayed, press this button to change among LAN, IEEE 802.11 a, and IEEE 802.11 b/g. (The wireless module is available through BenQ retailers.)
4. **Source** (Refer to ["Switching input signal" on page 29](#) for more information.)
Sequentially selects the input signal RGB, Component Video, S-Video, or Video.
5. **Auto** (Refer to ["Auto-adjusting the image" on page 27](#) for more information.)
Automatically determines the best picture timings for the displayed image.
When a wireless module is installed, the Wireless Connection menu is displayed and the IEEE 802.11 a is selected, press this button to search for a reliable channel. (The wireless module is available through BenQ retailers.)
6. **Lamp indicator light** (Refer to ["Indicators" on page 47](#) for more information.)
Indicates the status of the lamp. Lights up or flashes when the lamp has developed a problem.
7. **Temperature warning light** (Refer to ["Indicators" on page 47](#) for more information.)
Lights up red if the projector's temperature becomes too high.



FixYourDLP.com
Sponsored by

DiscountMerchant.com (800) 281-8860

THE TRUSTED SOURCE FOR PROJECTOR LAMP AND ACCESSORIES

8. **Power indicator light** (Refer to "[Indicators](#)" on page 47 for more information.)
Lights up or flashes when the projector is under operation.
9. **◀ Left**
10. **Right ▶** (Refer to "[Correcting keystone](#)" on page 28 for more information.)
When the on-screen menu is not activated, #9 and #10 function as **Keystone -/+** hot keys.
11. **▼ Menu** (Refer to "[Using the menus](#)" on page 32 for more information.)
Turns on the on-screen display control menu.
12. **▲ Exit**
Exits and saves the menu settings.
When the on-screen menu is activated, the #9 to #12 buttons are used as directional arrows to select the desired menu items and to make adjustments.
13. **Focus ring** (Refer to "[Fine-tuning the image size and clarity](#)" on page 28 for more information.)
Adjusts the focus of the projected image.
14. **Zoom ring** (Refer to "[Fine-tuning the image size and clarity](#)" on page 28 for more information.)
Adjusts the size of the image.

Remote control

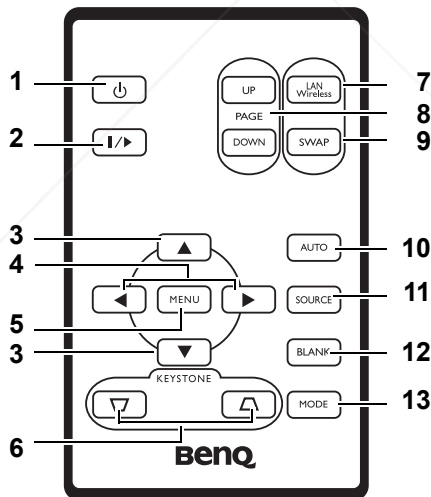

1. **Power** (Refer to "[Start up](#)" on page 25 and "[Shutdown](#)" on page 30 for more information.)

Turns the projector on or off.

2. **Freeze**

The image is frozen when **Freeze** is pressed. An icon " **||** " will display in the lower right corner of the screen. To release the function, press **Freeze** again.

3. **^ Up, v Down**
4. **^ Left, Right v**
When the on-screen menu is activated, the **^ Up, v Down, ^ Left and Right v** buttons are used as directional arrows to select the desired menu items and to make adjustments.
5. **Menu (Refer to "Using the menus" on page 32 for more information.)**
Turns on the on-screen display control menu.
Exits and saves the menu settings. (Pressing the **^ Up** button repeatedly can also exit and save the menu settings.)
6. **v Keystone v** (Refer to page "Correcting keystone" on page 28 for more information.)
Manually corrects distorted images resulting from an angled projection.
7. **LAN/Wireless (Refer to "Wireless connection (optional)" on page 18 for more information.)**
When a wireless module is installed and the Wireless Connection menu is displayed, press this button to toggle between LAN or Wireless connection modes. (The wireless module is available through BenQ retailers.)
8. **Page Up and Down (Refer to "Remote paging operations" on page 30 for more information.)**
You can operate your display software program (on a connected PC) which responds to page up/down commands (like Microsoft PowerPoint) by pressing these buttons.
9. **SWAP (Refer to "Wireless connection (optional)" on page 18 for more information.)**
When a wireless module is installed and the Wireless Connection menu is displayed, press this button to change the wireless connection mode between IEEE 802.11 a and IEEE 802.11 b/g. (The wireless module is available through BenQ retailers.)
10. **Auto (Refer to "Auto-adjusting the image" on page 27 for more information.)**
Automatically determines the best picture settings for the displayed image.
When a wireless module is installed, the Wireless Connection menu is displayed and the IEEE 802.11 a is selected, press this button to search for a reliable channel. (The wireless module is available through BenQ retailers.)
11. **Source (Refer to "Switching input signal" on page 29 for more information.)**
Sequentially selects the input signal RGB, Component Video, S-Video, or Video.
12. **Blank (Refer to "Hiding the image" on page 29 for more information.)**
Used to hide the screen image. Press any key on the remote control to restore the image.
13. **Mode (Refer to "Application Mode" on page 33 for more information.)**
Depending upon which input signal is selected, there are several picture setup options available.



Discount-Merchant.com (800) 281-8860
THE TRUSTED SOURCE FOR PROJECTOR LAMPS AND ACCESSORIES

Remote control effective range

Infra-Red (IR) remote control sensors are located on the front and the back of the projector. The remote control must be held at an angle within 30 degrees of the projector's IR remote control sensors to function correctly. The distance between the remote control and the sensors should not exceed 6 meters (~ 20 feet).

- **Operating the projector from the front**

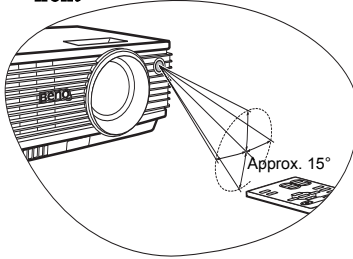

- **Operating the projector from the rear**

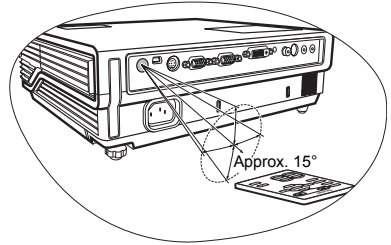

 **Make sure that there are no obstacles between the remote control and the IR sensors on the projector that might obstruct the infra-red beam.**

Replacing the remote control battery

1. Pull out the battery holder.
2. Insert the new battery in the holder. Note the positive polarity should face outward.
3. Push the holder into the remote control until it clicks into place.



- **Avoid excessive heat and humidity. There may be battery damage if the battery is incorrectly replaced.**
- **Replace only with the same or equivalent type recommended by the battery manufacturer.**
- **Dispose of the used battery according to the manufacturer's instructions.**
- **Never throw a battery into a fire. There may be danger of an explosion.**
- **If the battery is dead or if you will not be using the remote control for a long time, remove the battery to prevent damage to the remote control from possible battery leakage.**

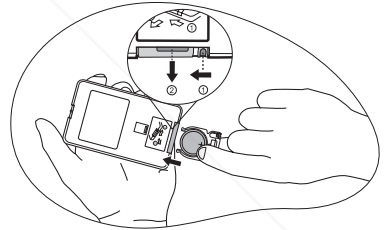

3 Positioning your projector

Choosing a location

Your projector is designed to be installed in one of four possible installation locations:

1. Floor in front of screen;
2. Ceiling in front of screen;
3. Floor at rear of screen;
4. Ceiling at rear of screen.

Your room layout or personal preference will dictate which installation location you select. Take into consideration the size and position of your screen, the location of a suitable power outlet, as well as the location and distance between the projector and the rest of your equipment.

 **If you use the projector with wireless function, there's no need to worry about data cable connections. This gives you the flexibility to site the projector anywhere in the room up to a range of 20m away from your notebook, and switch between presentations on different notebooks instantly without fiddling with cables**

To use the wireless function, you need to install a BenQ wireless module to the projector and enable your notebook/desktop PC with wireless connection. For more information, refer to "Wireless connection (optional)" on page 18.



Discount-Merchant.com (800) 281-8860
THE TRUSTED SOURCE FOR PROJECTOR LAMPS AND ACCESSORIES

I. Floor front

Select this location with the projector placed near the floor in front of the screen. This is the most common way to position the projector for quick setup and portability.

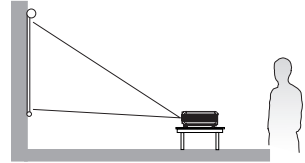

II. Ceiling front

Select this location with the projector suspended upside-down from the ceiling in front of the screen.

Purchase the BenQ Projector Ceiling Mounting Kit from your dealer to mount your projector on the ceiling.

Set **1** in the **Advance > Mirror** menu after you turn the projector on.

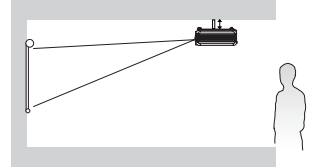

III. Floor rear

Select this location with the projector placed near the floor behind the screen.

Note that a special rear projection screen is required.

Set **3** in the **Advance > Mirror** menu after you turn the projector on.

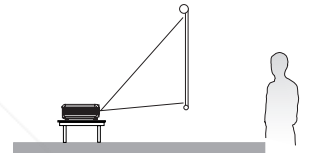

IV. Ceiling rear

Select this location with the projector suspended upside-down from the ceiling behind the screen.

Note that a special rear projection screen and the BenQ Projector Ceiling Mounting Kit are required for this installation location.

Set **4** in the **Advance > Mirror** menu after you turn the projector on.

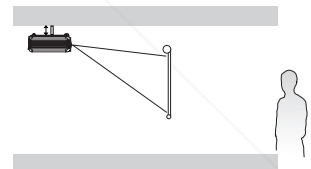

Obtaining a preferred projected image size

The distance from the projector lens to the screen, the zoom setting, and the video format each factors in the projected image size.

The maximum (native) resolution of the projector is 1024 x 768 pixels, which is a 4 to 3 aspect ratio (expressed as 4:3). To be able to project a complete 16:9 (widescreen) aspect ratio image, the projector can resize and scale a widescreen image to the projector's native aspect width. This will result in a proportionally smaller height equivalent to 75% of the projector's native aspect height.

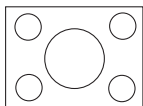

4:3 aspect image in a 4:3 aspect display area

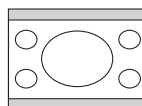

16:9 aspect image scaled to a 4:3 aspect display area

Thus, a 16:9 aspect image will not utilize 25% of the height of a 4:3 aspect image displayed by this projector. This will be seen as darkened (unlit) bars along the top and bottom (vertical 12.5% height respectively) of the 4:3 projection display area whenever displaying a scaled 16:9 aspect image in the vertical centre of the 4:3 projection display area.

When determining the position of your projector, you should consider its intended use and input signal aspect ratios. All inputs (other than composite Video being fed a 16:9 aspect signal) will display in a 4:3 aspect ratio (and will require an additional 33% display height than that of the scaled 16:9 aspect image projection area).

IMPORTANT: Do not select a permanent projector position based upon a 16:9 projection if you will ever need to select an input (other than composite Video being fed a 16:9 aspect signal).

The projector should always be placed horizontally level (like flat on a table), and positioned directly perpendicular (90° right-angle square) to the horizontal centre of the screen. This prevents image distortion caused by angled projections (or projecting onto angled surfaces).

The modern digital projector does not project directly forward (like older style reel-to-reel film projectors did). Instead, digital projectors are designed to project at a slightly upward angle above the horizontal plane of the projector. This is so that they can be readily placed on a table and will project forward and upwards onto a screen positioned so that the bottom edge of the screen is above the level of the table (and everyone in the room can see the screen).

If the projector is mounted on a ceiling, it must be mounted upside-down so that it projects at a slightly downward angle.

You can see from the diagram on page 17, that this type of projection causes the bottom edge of the projected image to be vertically offset from the horizontal plane of the projector. When ceiling mounted, this refers to the top edge of the projected image.

If the projector is positioned further away from the screen, the projected image size increases, and the vertical offset also increases proportionately.

When determining the position of the screen and projector, you will need to account for both the projected image size and the vertical offset dimension, which are directly proportional to the projection distance.

BenQ has provided a table of 4:3-aspect-ratio screen sizes to assist you in determining the ideal location for your projector. There are two dimensions to consider, the perpendicular horizontal distance from the centre of the screen (projection distance), and the vertical offset height of the projector from the horizontal edge of the screen (offset).



FixYourDisplay.com

DiscountProjector.com (800) 881-8860
THE TRUSTED SOURCE FOR PROJECTOR LAMPS AND ACCESSORIES

How to determine the position of the projector for a given screen size:

1. Select your screen size.
2. Refer to the table and find the closest match to your screen size in the left columns labelled 'Screen Diameter' Using this value, look across this row to the right to find the corresponding average distance from screen value in the column labelled 'Average'. This is the projection distance.
3. On that same row, look across to the right column and make note of the vertical Offset value. This will determine the final vertical offset placement of the projector in relation to the edge of the screen.
4. The recommended position for the projector is aligned perpendicular to the horizontal centre of the screen, at the distance from the screen determined in step 2 above, and offset by the value determined in step 3 above.

For example, if you are using a 120 inch screen, the average projection distance is 4691 mm and with a vertical offset of 46 mm.

If you place the projector in a different position (to that recommended), you will have to tilt it down or up to center the image on the screen. In these situations, some image distortion will occur. Use the Keystone function to correct the distortion. See "[Correcting keystone](#)" on [page 28](#) for keystone correction.

How to determine the recommended screen size for a given distance:

This method can be used for situations where you have purchased this projector and would like to know what screen size will fit in your room.

The maximum screen size is limited by the physical space available in your room.

1. Measure the distance between the projector and where you want to position the screen. This is the projection distance.
2. Refer to the table and find the closest match to your measurement in the average distance from screen column labelled 'Average'. Check that your measured distance is between the min and max distances listed on either side of the average distance value.
3. Using this value, look across that row to the left to find the corresponding screen diameter listed in that row. That is the projected image size of the projector at that projection distance.
4. On that same row, look across to the right column and make note of the vertical Offset value. This will determine the final placement of the screen in relation to the horizontal plane of the projector.

For example, if your measured projection distance was 4.5m (4500mm), the closest match in the Average column is 4617mm. Looking across this row shows that a 3000mm (3m) screen is required. If you can only obtain imperial sized screens, the listed screen sizes on either side of the 3m screen are the 9' and 10' screens.

Checking the min and max projection distance values for these screen sizes, indicates that the 4.5m measured projection distance will fit these screens too. The projector can be adjusted (using the zoom control) to display on these different screen sizes at that projection distance. Be aware that these different screens have different vertical offset values.

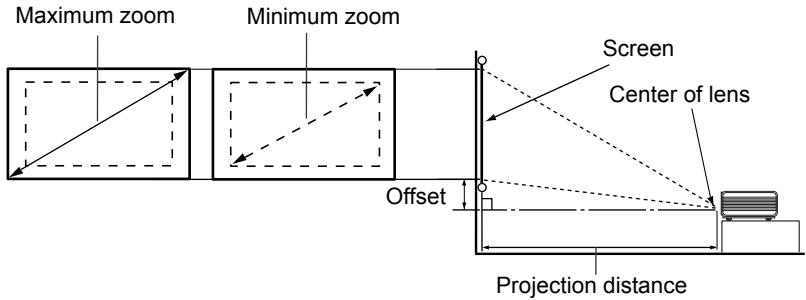

Screen Diameter			Distance from Screen in mm			Vertical Offset in mm
Feet	Inches	mm	Min length (with max. zoom)	Average	Max length (with min. zoom)	
4	48	1219	1745	1876	2007	18
		1500	2148	2199	2250	23
5	60	1524	2182	2345	2509	23
		1829	2618	2815	3011	27
6	72	2000	2863	3078	3293	30
		2134	3055	3284	3513	32
7	84	2438	3491	3753	4015	36
		2500	3579	3848	4116	38
8	96	2743	3927	4222	4516	41
		3000	4295	4617	4939	45
9	108	3048	4364	4691	5018	46
		3500	5011	5387	5763	53
10	120	3658	5236	5629	6022	55
		4000	5727	6157	6586	60
12	144	4572	6545	7036	7527	69
		5000	7158	7695	8232	75
15	180	5436	7855	8444	9033	82
		6000	8590	9234	9878	90
25	300	7620	10909	11727	12545	114

- ☞ The recommended focus range is from 1500-8000 millimeters (1.5-8 meters).
- There is 3%-5% tolerance among these numbers due to optical component variations.



Discount-Merchant.com (800) 281-8860
THE TRUSTED SOURCE FOR PROJECTOR LAMPS AND ACCESSORIES

4 Connection

When connecting a signal source to the projector, be sure to:

1. Turn all equipment off before making any connections.
2. Use the correct signal cables for each source.
3. Ensure the cables are firmly inserted.

 **In the connections shown below, some cables may not be included with the projector (see "Shipping contents" on page 6). They are commercially available from electronics stores.**

Wireless connection (optional)

The Wireless module allows for simultaneous wireless connectivity to multiple computers which are Wi-Fi enabled. This saves you from having to swap data cables between the projector and different computers during a presentation. Wi-Fi connectivity is most suitable for situations where multiple presenters with separate notebooks are required to seamlessly present individual presentations, like in meetings, conferences, lectures and, classrooms.

The Wireless module connects and attaches to the rear of the projector through the DVI-I socket.

 **Whilst the Wireless module is attached to the projector, you cannot use the DVI-I socket for DVI cable connections.**

Even though the projector may be using a wireless data connection, it still requires physical connection to a power outlet using its power cable.

You can purchase a BenQ wireless module from BenQ retailers. You should attach the wireless module to the projector before you connect any other cables. Refer to the user's manual enclosed with the wireless module for connection and operation details.

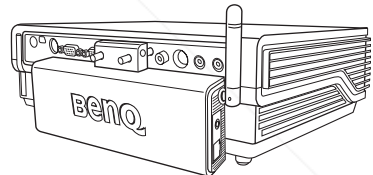

Projector with the wireless module

Cable connection

Connecting a computer or monitor

Connecting a computer

The projector provides a VGA and DVI input sockets that allow you to connect it to a notebook or desktop computer.

Additionally, you can also connect the projector to a computer via the USB cable so you can perform paging operations of the application on the PC or notebook. (see "Remote paging operations" on page 30).



FixYourDLP.com

Discover the [DiscoverTheChart.com](http://www.DiscoverTheChart.com) (800) 281-8860

THE TRUSTED SOURCE FOR PROJECTOR LAMPS AND ACCESSORIES

To connect the projector to a notebook or desktop computer (either through a VGA cable or VGA-DVI cable):

<ul style="list-style-type: none"> • With a VGA cable: <ol style="list-style-type: none"> 1. Take the supplied VGA cable and connect one end to the D-Sub output socket of the computer. 2. Connect the other end of the VGA cable to the D-SUB/COMP IN signal input socket on the projector. 	<ul style="list-style-type: none"> • With a VGA-DVI cable: <ol style="list-style-type: none"> 1. Take a VGA-DVI cable and connect the VGA end to the D-Sub output socket of the computer. 2. Connect the DVI end of the VGA-DVI cable to the DVI-I signal input socket on the projector.
<ol style="list-style-type: none"> 3. If you wish to use the remote paging function (see "Remote paging operations" on page 30), take the supplied USB cable and connect the larger end to the USB port of the computer, and the smaller end to the USB socket on the projector. 4. If you wish to make use of the projector (mixed mono) speaker in your presentations, take a suitable audio cable and connect one end of the cable to the audio output socket of the computer, and the other end to the AUDIO IN socket of the projector. 5. If you wish, you can use another suitable audio cable and connect one end of the cable to the Audio OUT socket* of the projector, and the other end to your external speakers (not supplied). <p>*The audio output is a mixed mono signal and controlled by the projector Volume and Mute settings.</p>	

The final connection path should be like that shown in the following diagram:

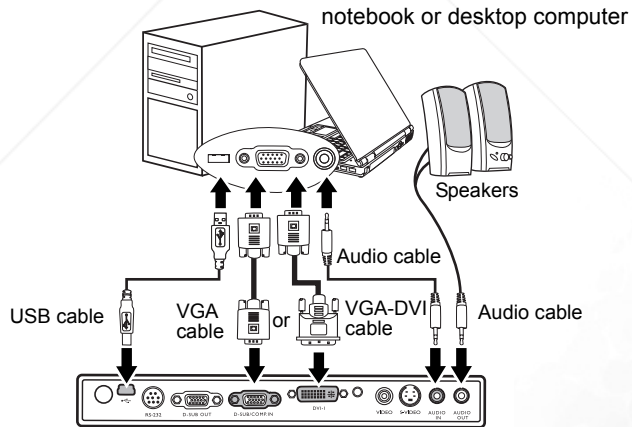

A Mac adapter (an optional accessory) is needed if you are connecting legacy version Macintosh computers.

- Many notebooks do not turn on their external video ports when connected to a projector. Usually a key combo like FN + F3 or CRT/LCD key turns the external display on/off. Locate a function key labeled CRT/LCD or a function key with a monitor symbol on the notebook. Press FN and the labeled function key simultaneously. Refer to your notebook's documentation to find your notebook's key combination.

Connecting a monitor

If you want to view your presentation close-up on a monitor as well as on the screen, you can connect the RGB signal output socket on the projector to an external monitor with a VGA cable by following the instructions below.

Note: The D-SUB output only works when an appropriate D-SUB input is made to the projector. Be sure the projector is connecting with the computer using the D-SUB IN socket, not the DVI socket.

To connect the projector to a monitor (either through a VGA cable or VGA-DVI cable):

<ul style="list-style-type: none"> With a VGA cable: 	<ul style="list-style-type: none"> With a VGA-DVI cable: <p>Note: You monitor must be equipped with a DVI input socket.</p>
<ol style="list-style-type: none"> 1. Connect the projector to a computer as described in "Connecting a computer" on page 18. 	
<ol style="list-style-type: none"> 2. Take a suitable VGA cable (only one supplied) and connect one end of the cable to the D-Sub input socket of the video monitor. 3. Connect the other end of the cable to the D-SUB OUT socket on the projector. 	<ol style="list-style-type: none"> 2. Take a VGA-DVI cable and connect the DVI end of the cable to the DVI input socket of the video monitor. 3. Connect the VGA end of the cable to the D-SUB OUT socket on the projector.

The final connection path should be like that shown in the following diagram:
notebook or desktop computer

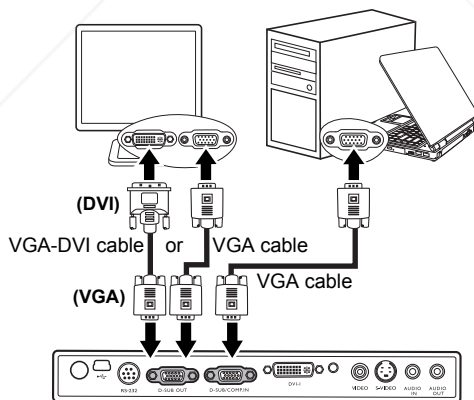

Connecting Video source devices

This section describes how to connect the projector to Video source devices using video cables. Video cable connections are recommended for Video presentations.

 **This projector also supports data (graphic) "PC" connection using Wi-Fi. Wi-Fi connection is not recommended for Video presentations. See ["Wireless connection \(optional\)" on page 18.](#)**

You can connect your projector to various Video source devices that provide any one of the following output sockets:

- Component Video
- S-Video
- Video (composite)

You need only connect the projector to a Video source device using just one of the above connecting methods, however each provides a different level of video quality. The method you choose will most likely depend upon the availability of matching terminals on both the projector and the Video source device as described below:

Best video quality

The best available video connection method is Component Video (not to be confused with composite Video). Digital TV tuner and DVD players output Component Video natively, so if available on your devices, this should be your connection method of choice in preference to (composite) Video.

See ["Connecting a Component Video source device" on page 22](#) for how to connect the projector to a component video device.

Better video quality

The S-Video method provides a better quality analog video than standard composite Video. If you have both composite Video and S-Video output terminals on your Video source device, you should elect to use the S-Video option.

See ["Connecting an S-Video source device" on page 23](#) for how to connect the projector to an S-Video device.

Least video quality

Composite Video is an analog video and will result in a perfectly acceptable, but less than optimal result from your projector, being the least video quality of the available methods described here.

See ["Connecting a composite Video source device" on page 24](#) for how to connect the projector to a composite Video device.

Connecting Audio

The projector has a built-in mono speaker which is designed to provide basic audio functionality accompanying data presentations for business purposes only. It is not designed for, nor intended for stereo audio reproduction use as might be expected in home theatre or home cinema applications. Any stereo audio input (if provided), is mixed into a common mono audio output through the projector speaker.

If you wish, you can make use of the projector (mixed mono) speaker in your presentations, and also connect separate amplified speakers to the Audio Out socket of the projector. The audio output is a mixed mono signal and controlled by the projector Volume and Mute settings.

If you have a separate sound system, you will most likely want to connect the audio output of your Video source device to that sound system, instead of to the mono audio projector.



FixYourDisplay.com
SOLUTIONS

Discount-Merchant.com (800) 281-8860
THE TRUSTED SOURCE FOR PROJECTOR PARTS AND ACCESSORIES

The audio connections illustrated in the following sections are provided for informational purposes only. You need not connect audio to the projector if there is an alternate sound system available, or if audio is not required.

Connecting a Component Video source device

Examine your Video source device to determine if it has a set of unused Component Video output sockets available:

- If so, you can continue with this procedure.
- If not, you will need to reassess which method you can use to connect to the device.

To connect the projector to a Component Video source device (either through a Component Video to VGA adaptor cable or DVI cable):

<ul style="list-style-type: none"> • With a Component Video to VGA (D-Sub) adaptor cable: 	<ul style="list-style-type: none"> • With a DVI cable:
<ol style="list-style-type: none"> 1. Take the (optional accessory) Component Video to VGA (D-Sub) adaptor cable and connect the end with 3 RCA type connectors to the Component Video output sockets of the Video source device. Match the color of the plugs to the color of the sockets; green to green, blue to blue; and red to red. 2. Connect the other end of the Component Video to VGA (D-Sub) adaptor cable (with a D-Sub type connector) to the D-SUB/COMP IN socket on the projector. 	<ol style="list-style-type: none"> 1. Take a DVI cable and connect one end of the cable to the DVI output socket of the Video source device. 2. Connect the other end of the cable to the DVI-I socket on the projector.
<ol style="list-style-type: none"> 3. If you wish, you can use another suitable audio cable and connect one end of the cable to the AUDIO OUT socket of the projector, and the other end to your external speakers (not supplied). 	

The final connection path should be like that shown in the following diagram:

A/V device

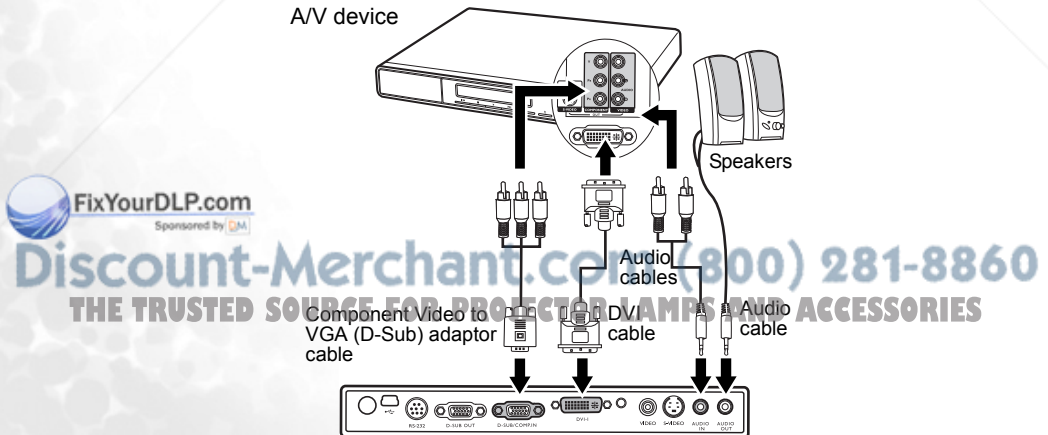

- The projector is only capable of playing mixed mono audio, even if a stereo audio input is connected. See ["Connecting Audio" on page 21](#) for details.
- **Component Video is the only video output that delivers native 16:9 aspect ratio picture.**

If you connect the projector to a High Definition TV (HDTV) tuner, the following standards are supported:

- | | |
|--------------------|---------------------|
| • 480i | • 480p |
| • 576i | • 576p |
| • 720p (50/ 60 Hz) | • 1080i (50/ 60 Hz) |

- If the selected video image is not displayed after the projector is turned on and the correct video source has been selected, check that the Video source device is turned on and operating correctly. Also check that the signal cables have been connected correctly.

Connecting an S-Video source device

Examine your Video source device to determine if it has an unused S-Video output socket available:

- If so, you can continue with this procedure.
- If not, you will need to reassess which method you can use to connect to the device.

To connect the projector to an S-Video source device:

1. Take a S-Video cable and connect one end to the S-Video output socket of the Video source device.
2. Connect the other end of the S-Video cable to the S-VIDEO socket on the projector.
3. If you wish, you can use another suitable audio cable and connect one end of the cable to the AUDIO OUT socket of the projector, and the other end to your external speakers (not supplied).

The final connection path should be like that shown in the following diagram:

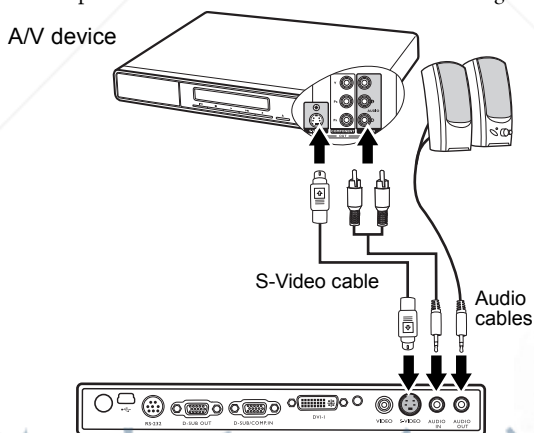

- The projector is only capable of playing mixed mono audio, even if a stereo audio input is connected. See ["Connecting Audio" on page 21](#) for details.

- If the selected video image is not displayed after the projector is turned on and the correct video source has been selected, check that the Video source device is turned on and operating correctly. Also check that the signal cables have been connected correctly.

- If you have already made a Component Video connection between the projector and this S-Video source device using Component Video connections, you need not connect to this device using an S-Video connection as this makes an unnecessary second connection of poorer picture quality. See ["Connecting Video source devices" on page 21](#) for details.

Connecting a composite Video source device

Examine your Video source device to determine if it has a set of unused composite Video output sockets available:

- If so, you can continue with this procedure.
- If not, you will need to reassess which method you can use to connect to the device.

To connect the projector to an composite Video source device:

1. Take the Video cable and connect one end to the composite Video output socket of the Video source device.
2. Connect the other end of the Video cable to the VIDEO socket on the projector.
3. If you wish, you can use another suitable audio cable and connect one end of the cable to the AUDIO OUT socket of the projector, and the other end to your external speakers (not supplied).

The final connection path should be like that shown in the following diagram:

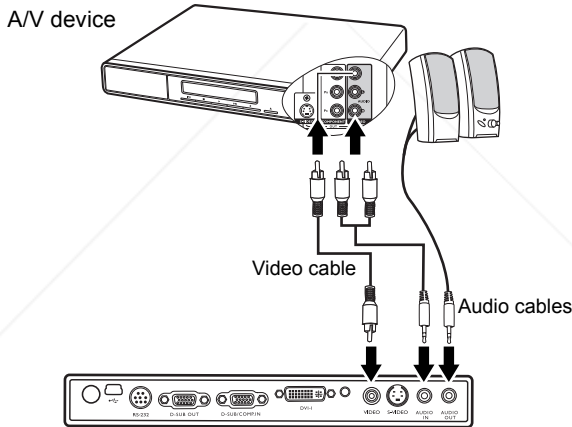

- ☞ • The projector is only capable of playing mixed mono audio, even if a stereo audio input is connected. See ["Connecting Audio" on page 21](#) for details.
- If the selected video image is not displayed after the projector is turned on and the correct video source has been selected, check that the Video source device is turned on and operating correctly. Also check that the signal cables have been connected correctly.

You need only connect to this device using a composite Video connection if Component Video and S-Video inputs are unavailable for use. See ["Connecting Video source devices" on page 21](#) for details.

5 Operation

Start up

1. Plug the power cord into the projector and into a wall socket. Turn on the wall socket switch (where fitted). Check that the **Power indicator** on the projector lights orange after power has been applied.
2. Remove the lens cap. If it is left on, it could become deformed due to the heat produced by the projection lamp.
3. Press and hold (for 2 seconds) the **Power** button on the remote control or projector to start the unit. The **Power indicator light** flashes green and stays green when the unit is on. The start up procedure takes about 30 seconds after pressing **Power**. In the later stage of start up, a default BenQ logo is projected. (If necessary) Rotate the focus ring to adjust the image clearness.

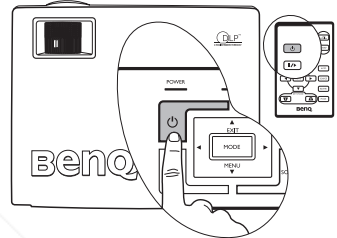
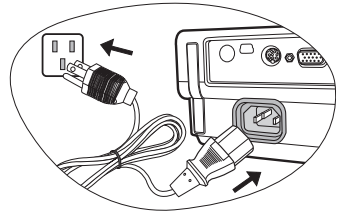

If the projector is still hot from previous activity, it will run the cooling fan for approximately 90 seconds before energising the lamp.

4. If you are prompted for a password, press the arrow buttons to select the four password digits, then press **Auto**. For information about the password function, refer to "[Utilizing the password function](#)" on page 25.
5. Switch all of the connected equipment on.
6. The projector will start to search for input signals. The current input source being scanned displays at the center of the screen. The search will continue until an input source signal is detected.

You can also press **Source** on the projector or remote control to select your desired input signal. For more information, please refer to "[Switching input signal](#)" on page 29.

If the frequency/ resolution of the input signal exceeds the projector's operating range, you will see the message "Out of Range" displayed on a blank screen.

Utilizing the password function

For security purposes and to help prevent unauthorized use, the projector includes an option for setting up password security. The password can be set through the on-screen menu. For details of the on-screen menu operation, please refer to "[Using the menus](#)" on page 32 for information.

WARNING: You will be inconvenienced if you activate the password functionality and subsequently forget the password. Print out this manual (if necessary) and write the password you used in this manual, and keep the manual in a safe place for later recall.

To set a password:

 **CAUTION:** Once a password has been set, the projector cannot be used unless the correct password is entered every time the projector is started.

1. Open the on-screen menu and go to  **Setting > Password**. Select **On** by pressing **Left** ◀ or **Right** ▶.
2. When the function is activated for the first time, a prompt will display on the screen. Use the **Up** ▲ or **Down** ▼ button to select a number for each digit of the password. Use the **Left** ◀ or **Right** ▶ button to move between the digits of the password.
3. When all digits are entered and the password is ready, press **Auto** to confirm. A confirmation message displays.

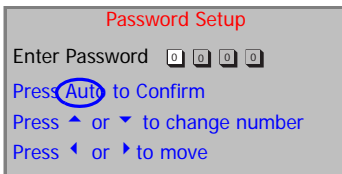

-  • **The password will display on-screen when being input.**
- **IMPORTANT:** Write your selected password down here in this manual so that it is available to you should you ever forget it.

Password: _ _ _ _

Keep this manual in a safe place.

4. Perform one of the following 3 steps.
 - i. Press **Auto** to continue. The set-up is finished when the message “Password setup completed” displays.
 - ii. Press **Up** ▲ to go back to the previous screen and re-enter four digits.
 - iii. Press **Down** ▼ to cancel the password set-up and return to the on-screen menu.

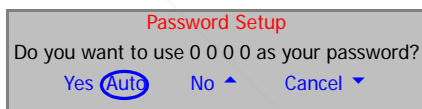

If you forget the password:

You will be asked to enter the four digit password every time you turn on the projector. If you enter the wrong password, the password error message displays. You can retry by pressing **Up** ▲, pressing **Power** to turn off the projector and start again, or if you did not record the password in this manual, and you absolutely do not remember it, you can use the password recall procedure.

To enter the password recall procedure:

Press and hold **Right** ▶ for 5 seconds. The projector will display a coded number on the screen. Seek help from the local BenQ service center to decode the number. You may be required to provide proof of purchase documentation to verify that you are an authorized user of the projector.

To change the password:

1. Open the on-screen menu and go to  **Setting > Change Password**.
2. Press **Left** ◀ or **Right** ▶. A “Password Change” message displays.
3. Enter the old password.
 - i. If the password is correct, you can go on to enter new password.

IMPORTANT: Write your selected password down here in this manual so that it is available to you should you ever forget it.

Password: _____

Keep this manual in a safe place.

- ii. If the password is incorrect, a "Password Error" message displays. Press **Up** \blacktriangle to try again or press **Down** \blacktriangledown to cancel.
4. Check the new password.
 - i. Pressing **Auto** completes the procedure.
 - ii. Press **Up** \blacktriangle to try again.
 - iii. Press **Down** \blacktriangledown to cancel the set-up and return to the on-screen menu.

Adjusting the height

The projector is equipped with 1 quick-release adjuster foot and 1 rear adjuster foot. These adjusters change the image height and projection angle. To adjust the projector:

1. Lift the projector up and press the adjuster button to release the adjuster. The adjuster will drop into position and be locked.

Do not look into the lens while the lamp is on. The strong light from the lamp may cause damage to your eyes.

Be careful when you press the adjuster button as it is close to the exhaust vent where hot air comes from.

2. Screw the rear adjuster foot to fine tune the horizontal angle.

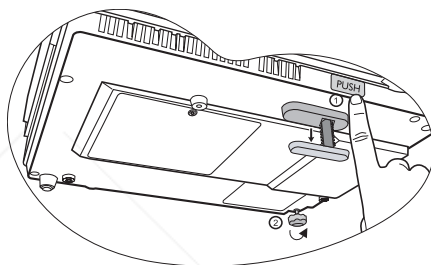

To retract the foot, hold up the projector while pressing the front adjuster button, then slowly lower the projector. Screw the rear adjuster foot in a reverse direction.

If the screen and the projector are not perpendicular to each other, the projected image becomes vertically trapezoidal. To correct this situation, adjust the value of Keystone in the Picture menu, on the projector control panel, or on the remote control. Refer to "Correcting keystone" on page 28 for details.

Auto-adjusting the image

In some cases, you may need to optimize the picture quality. To do this, press **Auto** on the control panel of the projector or on the remote control. Within 3 seconds, the built-in Intelligent Auto Adjustment function will re-adjust the values of Frequency and Clock to provide the best picture quality.

The current source information will be displayed at the bottom right of the screen for 3 seconds.

The screen will be blank while Auto is functioning.

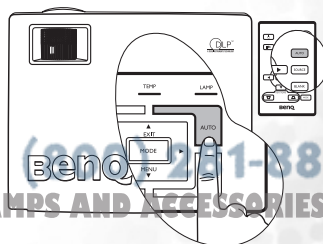

Fine-tuning the image size and clarity

1. Adjust the projected image to the size that you need using the zoom ring.
2. Then sharpen the image by rotating the focus ring.

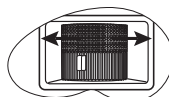
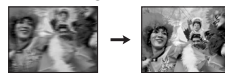
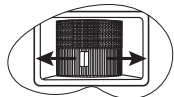

Correcting keystone

Keystoning refers to the situation where the projected image is noticeably wider at either the top or bottom. It occurs when the projector is not perpendicular to the screen.

To correct this, besides adjusting the height of the projector, you will need to manually correct it following ONE of these steps.

1. Press **Left/Right** on the control panel of the projector to display the status bar labelled Keystone. Press **Left** to correct keystone at the top of the image. Press **Right** to correct keystone at the bottom of the image.

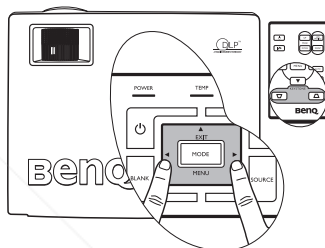

2. Press ∇ / \triangle on the remote control to display the status bar labelled Keystone, then press ∇ to correct keystone at the top of the image or press \triangle to correct keystone at the bottom of the image.

3. Press **Menu** on the projector or **Menu** on the remote control. Go to **Picture** --> **Keystone** and adjust the values by pressing **Left** / **Right** on the projector or **Left** / **Right** on the remote control.

For example,



Keystone

 0

1. Press **Left** on the projector or
2. Press ∇ on the remote control or
3. Press **Left** on the projector or **Left** on the remote control when you are in Picture --> Keystone menu.



Keystone

 -6



Keystone

 0

1. Press **Right** on the projector or
2. Press \triangle on the remote control or
3. Press **Right** on the projector or **Right** on the remote control when you are in Picture --> Keystone menu.



Keystone

 +6

Selecting an application mode

The projector is preset with several predefined application modes so that you can choose one to suit your operating environment and input source picture type. To select an operation mode that suits your need, press **Mode**. The picture modes available for different types of signals are shown below. See "[Application Mode](#)" on page 33 for details.

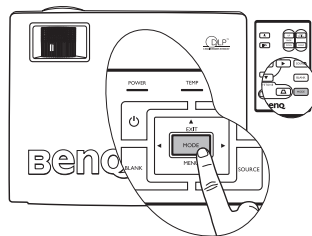

PC Signal Input				
Brightest (default)	Presentation	sRGB/Photo	Gaming	Video
YPbPr / S-Video / Video Signal Input				
Movie (default)	Cinema	Gaming	Photo	

Switching input signal

The projector can be connected to multiple devices at the same time. However, it can only display one at a time. To cycle through the available input sources, press the **Source** button on the projector control panel or the remote control. The selected source name will display at the center of the screen for 3 seconds after each button press.

 The brightness level of the projected image will change accordingly when you switch between different input signals. Data (graphic) "PC" presentations using mostly static images are generally brighter than "Video" using mostly moving images (movies).

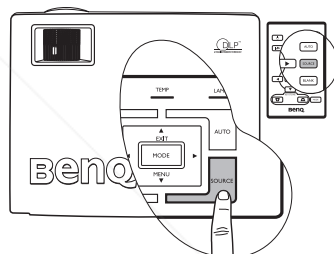

The input type effects the options available for the Application Mode. See "[Selecting an application mode](#)" on page 29 for details.

Hiding the image

In order to draw the audience's full attention to the presenter, you can use **Blank** to hide the screen image. Press any key on the control panel to restore the image. The word "**BLANK**" appears at the bottom right corner of the screen while the image is hidden. When this function is activated with an audio input connected, the audio can still be heard.

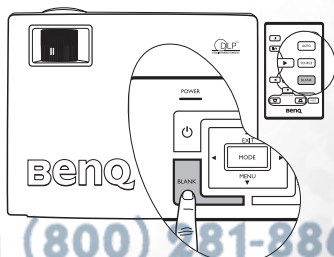

Remote paging operations

You can operate your display software program (on a connected PC) which responds to page up/down commands (like Microsoft PowerPoint) by pressing **Page Up** and **Page Down** on the remote control. See "[Connecting a computer](#)" on page 18 for details.

 **Connect the projector to your PC or notebook with a USB cable prior to using this function.**

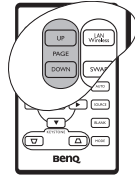

Freezing the image

Press the **Freeze** button on the remote control to freeze the image. An icon

 will display in the lower right corner of the screen. To release the function, press the **Freeze** button on the remote control, or the **Source** button on the projector control panel. Note that pressing the **Source** button will also change the input source.

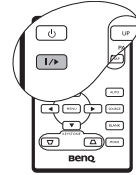

Even if an image is frozen on the screen, the pictures are running on the video or other device. If the connected devices have active audio output, you will still hear the audio even though the image is frozen.

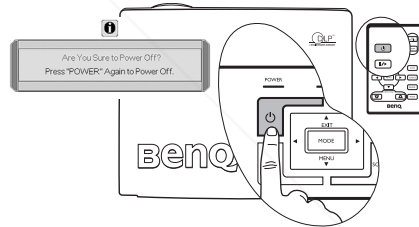

Shutdown

1. Press **Power** and a prompt message appears. Press **Power** a second time to turn the projector off.
2. The **Power indicator light** flashes orange and the lamp shuts down, the fans continue to run for approximately 90 seconds to cool down the projector.



-  **To protect the lamp, the projector will not respond to any commands during the cooling process.**
 - To shorten the cooling time, you can also activate the Quick cooling function. See "[Quick Cooling \(off\)](#)" on page 36 for details.**
3. Disconnect the power cord from the wall socket.
-  **Do not unplug the power cord before the projector shutdown sequence is complete or during the 90-second cooling down process.**

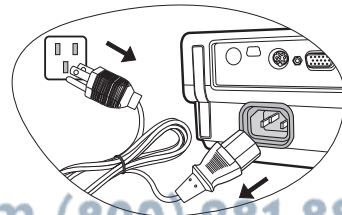

If the projector is not properly shut down, you risk damaging the lamp. Do not move the projector whilst the lamp is hot.







FixYourDL.com
Sponsor

Discount-Merchant.com (800) 281-8860
THE TRUSTED SOURCE FOR PROJECTOR LAMPS AND ACCESSORIES

Menu operation

Menu system

Please note that the on-screen display (OSD) menus vary according to the signal type selected.

Functions available when receiving different signal types...				
Sub-Menu	PC / DVI-A	Wireless / DVI-D	Video / S-Video	Component Video
 Picture	Application Mode Keystone Color Temp Brightness Contrast		Application Mode Keystone Color Temp Brightness Contrast Color Tint*	
 Pro-Picture	Auto Resize Aspect Ratio H Position V Position Phase H. Size	Auto Resize (not available with Wireless selected) Aspect Ratio	Auto Resize Aspect Ratio Sharpness	
 Setting	Mute Volume OSD Time Quick Cooling Password Change Password Reset			
 Advance	Mirror Blank Time Source Scan Language Splash Screen High Altitude Mode Auto Off Economic Mode			
 Information	Source Resolution Application Mode Equivalent Lamp Hour		Source System Application Mode Equivalent Lamp Hour	Source Resolution Application Mode Equivalent Lamp Hour

*When a Video or S-Video signal is connected, the function is only available with NTSC system selected.

Using the menus

The projector is equipped with on-screen display (OSD) menus for making various adjustments and settings.

There are 17 different menu languages. (Refer to page "4. Advance menu" on page 37 for more details.)

The following example describes the adjustment of the keystone.

1. Press **▼ Menu** on the projector or **Menu** on the remote control to turn the on-screen menu on.
4. Adjust keystone values by pressing **▲ / ▼** on the projector or remote control.

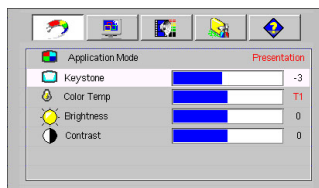
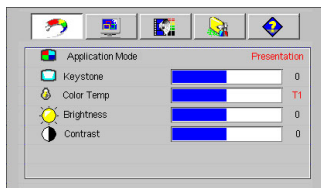

2. Use **◀ / ▶** on the projector or remote control to select the  **Picture** menu.
3. Press **▲ Exit / ▼ Menu** on the projector or **▼ / ▲** on the remote control to select **Keystone**.
5. Press **▲ Exit** on the projector repeatedly or press **Menu** on the remote control to leave and save the setting.

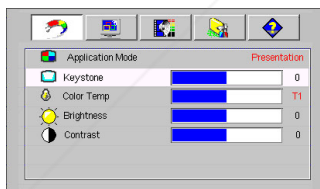













1. Picture menu

 Some picture adjustments are available only when certain input sources are in use. Unavailable adjustments are not shown on the screen.

FUNCTION (default setting / value)	DESCRIPTION
<p>Application Mode</p> <p>(PC: Brightest;</p> <p>YPbPr/ S-Video/ Video: Movie)</p>	<p>Pre-defined application modes are provided so you can optimize your projector image set-up to suit your program type.</p> <p> You can use the remote control 'Mode' button to select a predefined application mode. See "Selecting an application mode" on page 29 for details.</p> <p>PC Signal Input</p> <ol style="list-style-type: none"> Brightest Mode (Default): Maximizes the brightness of the projected image. This mode is suitable for environments where extra-high brightness is required, such as using the projector in well lit rooms. Presentation Mode: Is designed for presentations. The brightness is emphasized in this mode to match PC and notebook coloring. sRGB/Photo Mode: Maximizes the purity of RGB colors to provide true-to-life images regardless of brightness setting. It is most suitable for viewing photos taken with an sRGB compatible and properly calibrated camera, and for viewing PC graphic and drawing applications such as AutoCAD. Gaming Mode: Is suitable for playing PC-based games in a bright living room. Video Mode: Is appropriate for playing movies, video clips from digital cameras or DVs through the PC input for best viewing in a blackened (little light) environment. <p>YPbPr/ S-Video/ Video Signal Input</p> <ol style="list-style-type: none"> Movie Mode (Default): Is suitable for enjoying colorful movies and TV in a home darkened (not bright) lounge room lighting level environment. Cinema Mode: Is suitable for enjoying DVD movies best viewed in a blackened (little light) home cinema or lounge room environment. Gaming Mode: Is suitable for playing gamebox-based video games in a normal living room lighting level environment. Photo Mode: Is perfect for viewing digital photos taken in daylight with an sRGB compatible and properly calibrated camera, and for viewing Photo CDs. The color saturation and brightness are well-balanced.
<p>Keystone (0)</p>	<p>Corrects any keystone of the image. Refer to "Correcting keystone" on page 28 for more information.</p>











Discount-Mercant.com (800) 281-8860
 THE TRUSTED SOURCE FOR PROJECTOR LAMPS AND ACCESSORIES

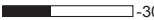

<p>Color Temp (depends on the selected Application mode)</p>	<p>There are four color temperature* settings are available.</p> <ol style="list-style-type: none"> T1: With the highest color temperature, T1 makes the image appear the most bluish white than other settings. T2: Makes images appear bluish white. T3: Maintains normal colorings for white. T4: Makes images appear reddish white. <p>*About color temperatures:</p> <p>There are many different shades that are considered to be “white” for various purposes. One of the common methods of representing white color is known as the “color temperature”. A white color with a low color temperature appears to be reddish white. A white color with a high color temperature appears to have more blue in it.</p>
<p>Brightness (depends on the selected input source)</p>	<p>Adjusts the brightness of the image. The higher the value, the brighter the image. And lower the setting, darker the image. Adjust this control so the black areas of the image appear just as black and that detail in the dark areas is visible.</p> <div style="display: flex; justify-content: space-around; align-items: flex-end;"> <div style="text-align: center;">   </div> <div style="text-align: center;">   </div> <div style="text-align: center;">   </div> </div>
<p>Contrast (depends on the selected input source)</p>	<p>Adjusts the degree of difference between dark and light in the image. The higher the value, the greater the contrast. Use this to set the peak white level after you have previously adjusted the Brightness setting to suit your selected input and viewing environment.</p> <div style="display: flex; justify-content: space-around; align-items: flex-end;"> <div style="text-align: center;">   </div> <div style="text-align: center;">   </div> <div style="text-align: center;">   </div> </div>
<p>Color (depends on the selected input source)</p>	<p>Increases or decreases the color intensity of the image.</p>
<p>Tint (50)</p>	<p>Adjusts the color tones of the image. The higher the value, the more greenish the image becomes. The lower the value, the more reddish the image becomes.</p> <p> When a Video or S-Video signal is connected, the function is only available with NTSC system selected.</p>

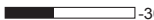
2. Pro-Picture menu

 Some picture adjustments are available only when certain input sources are in use. Unavailable adjustments are not shown on the screen.

FUNCTION (default setting / value)	DESCRIPTION
Auto Resize (on)	<p>Automatically resizes the input signal pixel resolution to the native resolution of the projector.</p> <p>On: The pixel resolution of the input signal is converted to the native resolution of the projector (1024 X 768). For input signals with lower resolutions, gaps in the pixels are automatically interpolated into the image before being projected. This may distort the image clarity.</p> <p>Off: The image is projected as its original resolution, with no pixel conversion. For input signals with lower resolutions, the projected image will display smaller than if resized to full screen. You could adjust the zoom setting or move the projector towards the screen to increase the image size if necessary. You may also need to refocus the projector after making these adjustments.</p>
Aspect Ratio (4:3)	<p>There are two aspect ratio settings.</p> <p>1. 4:3 (for a standard screen) 2. 16:9 (for a wide screen)</p> <p> 16:9 aspect ratio is only sourced through the Component Video input when being fed an appropriate 16:9 aspect signal. See "Connecting a Component Video source device" on page 22 and "Obtaining a preferred projected image size" on page 15 for details.</p>
H Position (0)	<p>Adjusts the horizontal position of the projected image.</p> <div style="display: flex; justify-content: space-around; align-items: center;">   </div> <div style="display: flex; justify-content: space-around; align-items: center;"> <div style="text-align: center;">  <p>-30</p> </div> <div style="text-align: center;">  <p>+30</p> </div> </div>
V Position (0)	<p>Adjusts the vertical position of the projected image.</p> <div style="display: flex; justify-content: space-around; align-items: center;">   </div> <div style="display: flex; justify-content: space-around; align-items: center;"> <div style="text-align: center;">  <p>-30</p> </div> <div style="text-align: center;">  <p>+30</p> </div> </div>
Phase (depends on the selected input source)	<p>This function allows you to adjust the clock phase to reduce image distortion.</p> 
H Size (0)	<p>Adjusts the horizontal width of the image.</p>
Sharpness (15)	<p>Adjusts the image to make it look sharper or softer.</p>

3. Setting menu

FUNCTION (default setting / value)	DESCRIPTION
Mute (off)	Toggles projector audio between on and off.
Volume (5)	Adjusts audio volume level.
OSD Time (10)	Sets the length of time the OSD will remain active after your last button press. The range is from 5 to 100 seconds.
Quick Cooling (off)	Enables or disables the Quick Cooling function. Selecting On enables the function and projector cooling time will be shortened from a normal 90-second duration to approximately 30 seconds.
Password (off)	<p>This is a selectable function. Selecting On limits use of the projector to only those who know the correct password. When the function is activated for the first time, you have to set a password for it. For more information, refer to "Utilizing the password function" on page 25. Once the password is set and this function is selected, the projector is password-protected. Users who do not know the correct password can not use the projector.</p> <p> WARNING: You will be inconvenienced if you activate the password functionality and subsequently forget the password.</p> <p>Print out this manual (if necessary) and write the password you used in this manual, and keep the manual in a safe place for later recall.</p> <p>The password can be entered by using either the buttons on the projector or the remote control.</p> <p> The password will display on-screen when being input.</p>
Change Password	You will be asked to enter the current password before changing to a new one. For more information, refer to " Utilizing the password function " on page 25.
Reset	<p>Returns all settings to the factory preset values.</p> <p> The following settings will still remain: Mirror, Language, Password, High Altitude Mode, Phase and H Position.</p>

4. Advance menu

FUNCTION (default setting / value)	DESCRIPTION
Mirror (Floor front)	The projector can be installed on a ceiling or behind a screen, or with one or more mirrors. Contact your dealer for the ceiling mount bracket (optional accessory) if you need to install the projector on your ceiling. Refer to " Choosing a location " on page 13 for more information.
Blank Time (20)	Sets the image blank time when the Blank feature is activated, once elapsed the image will return to the screen.
Source Scan (on)	Sets whether the projector searches automatically for input signals. If the source scan is On , the projector will scan for input signals until it acquires a signal. If the function is not activated, the projector selects the last used input signal. The default value is `RGB`.
Language (English)	Language sets the language for the OSD control menus. Use Left ◀ / Right ▶ on the projector or Left ◀ / Right ▶ on the remote control to select your desired language.
Splash Screen (BenQ logo)	Allows you to select which logo screen will display during projector start-up. Three modes are available: Default (BenQ logo), black screen or blue screen.

High Altitude Mode (off)	<p>A mode for operation in areas like high altitude or high temperature. We recommend you use the High Altitude Mode when your environment is higher than 3000 feet above sea level, or is hotter than 40°C, or whenever the projector will be used for extended periods of time (>10 hours) without shutdown.</p> <p>To activate the High Altitude Mode, select On by pressing Left ◀ / Right ▶ on the projector or remote control. A confirmation message displays. Press Auto.</p> <div data-bbox="333 320 996 456" style="border: 1px solid gray; padding: 5px; text-align: center;"> <p style="color: red; font-size: small;">We recommend you use the High Altitude Mode by selecting On when your environment is higher than 3000 feet, or is hotter than 40°C.</p> <p>Do you want to turn on High Altitude Mode?</p> <p>Yes Auto No ◀</p> </div> <p>Next time you turn on the projector, it will show a message pictured below as a reminder during the start-up.</p> <div data-bbox="333 523 996 644" style="border: 1px solid gray; padding: 5px; text-align: center;"> <p style="color: red; font-size: small;">Current Status</p> <p>High Altitude Mode On</p> <p style="font-size: x-small;">This mode is used for protecting projector from extreme environment and may cause high fan speed.</p> </div> <p>Operation under "High Altitude Mode" may cause a higher decibel operating noise level because of increased fan speed necessary to improve overall system cooling and performance.</p> <p>If you use this projector under other extreme conditions excluding the above, it may display auto shut-down symptoms, which is designed to protect your projector from over-heating. In cases like this, you should switch to High Altitude mode to solve these symptoms. However, this is not to state that this projector can operate under any and all harsh or extreme conditions.</p>
Auto Off (off)	<p>This function allows the projector to turn off automatically if no input signal is detected after a set period of time. Press Left ◀ / Right ▶ on the projector or remote control to set the duration before the projector is turned off. Selecting Off disables this function.</p>
Economic Mode (off)	<p>Use this mode to reduce system noise and reduce power consumption by 20%. If this mode is activated, the light output will be reduced and result in darker projected images.</p> <p>☞ Setting the projector in Economic mode extends the lamp timer automatic shutdown feature. For more information on how the total lamp hour is calculated, see "Calculation of lamp hour" on page 43.</p>

5. Information menu

This menu shows you the current operating status of the projector.

 **Some picture adjustments are available only when certain input sources are in use. Unavailable adjustments are not shown on the screen.**

FUNCTION	DESCRIPTION
Source	Shows the current signal source.
Resolution	Shows the native resolution of the input signal.
Application Mode	Shows the selected mode in the  Picture menu.
Equivalent Lamp Hour	Displays the number of hours the lamp has been used.
System	Shows the Video input system format, NTSC, SECAM or PAL.

6 Maintenance

Care of the projector

Your projector needs little maintenance. The only thing you need to do on a regular basis is to keep the lens clean.

Never remove any parts of the projector except the lamp. Contact your dealer if other parts need replacing.

Cleaning the lens

Clean the lens whenever you notice dirt or dust on the surface.

- Use a canister of compressed air to remove dust.
- If there is dirt or smears, use lens-cleaning paper or moisten a soft cloth with lens cleaner and gently wipe the lens surface.

 **Never rub the lens with abrasive materials.**

Cleaning the projector case

Before you clean the case, turn the projector off using the proper shutdown procedure as described in "Shutdown" on page 30 and unplug the power cord.

- To remove dirt or dust, wipe the case with the supplied cleaning cloth.
- To remove stubborn dirt or stains, moisten a soft cloth with water and a neutral pH detergent. Then wipe the case.

 **Never use wax, alcohol, benzene, thinner or other chemical detergents. These can damage the case.**

Storing the projector

If you need to store the projector for an extended time, please follow the instructions below:

- Make sure the temperature and humidity of the storage area are within the recommended range for the projector. Please refer to "Specifications" on page 51 or consult your dealer about the range.
- Retract the adjuster feet.
- Remove the batteries from the remote control.
- Pack the projector in its original packing or equivalent.

Transporting the projector

It is recommended that you ship the projector with its original packing or equivalent. When you carry the projector yourself, please use the original box or provided soft carry case.

Cleaning and replacing the dust filter

It is necessary to clean the dust filter periodically. If the filter is not cleaned, it can become clogged with dust and prevent proper ventilation. This can cause overheating and a malfunction of the projector.

A warning message like the one pictured to the right will be displayed for 10 seconds every 500 hours to remind you to clean the filter. To leave the message, press the **Exit** button on the projector or remote control.

Please check if the filter is clean
Clean the filter or replace with a new one
Press "Exit" to leave

To clean the filter:

1. Turn the projector off and wait until the fans stop running.
2. Disconnect the projector from any cables.
3. Locate the filter case on the back of the projector.

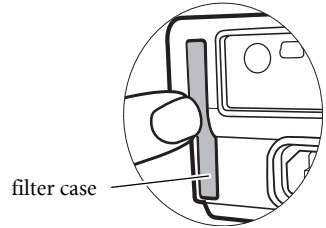

4. Release the filter case from the projector by pressing the filter case into the slot slightly. The filter case springs out of the slot.

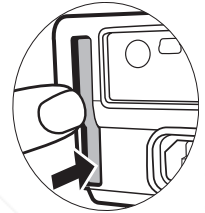

5. Pull out the filter case.

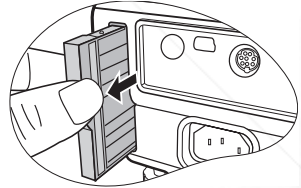

6. Use a small vacuum cleaner designed for computers and other office equipment to clean the filter sponge. Or use a soft brush (such as a clean artist's paintbrush) to gently sweep the dust on the filter away.

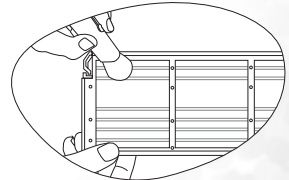

If the dirt is difficult to remove or the filter is broken, replace it with the supplied spare filter sponge. See "How to replace the filter sponge:" below.

7. Refit the filter case by aligning and inserting it into the projector slot.
8. Press the case back until it clicks into place.
9. Turn the projector back on.

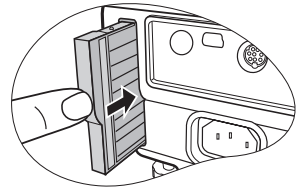

If the case is not correctly seated in place, the projector will display an on-screen message as pictured to the right every three minutes.

The message will display 3 times for a 10-second duration each, if no further action is taken.

Then a second message as pictured below displays to warn of shutdown in 1 minute.

Please check
Filter not well attached

Please re-attach the filter cap
Otherwise, Power is going to shut down in 1 minute

You can re-attach the case correctly anytime before the projector shuts down. (That means you have 10-11 minutes to get the re-attachment done from the time the first warning message was displayed.) The projector will return to normal operation.

How to replace the filter sponge:

If you find the dirt is hard to remove from the filter sponge or the sponge is broken, replace it.

1. Carefully peel the filter sponge away from the filter case. See that there are small plastic pins along the edges to position and retain the sponge into place. Lift the sponge up off these pins taking care to prevent them from breaking off.
2. Attach the supplied new filter sponge to the filter case. Make sure that the tiny holes securely fit onto the case's pins.

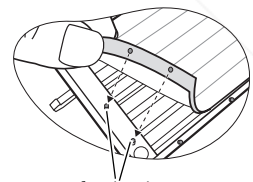
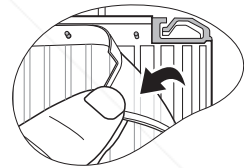

Plastic pins

Lamp information

Calculation of lamp hour

When the projector is in operation, the duration (in hours) of lamp usage is automatically calculated by the built-in timer. The method of calculating the equivalent lamp hour is as follows:

Total (equivalent) lamp hour = hours used in Economic mode + hours used in normal mode

☞ See **"Economic Mode (off)" on page 38** for more information on Economic mode.

The lamp hour in Economic mode is calculated as 3/4 of that in normal mode. That is, using the projector in Economic mode helps to extend the lamp hour by 1/4.





Warning message

When the **Lamp indicator** lights up red or a message appears suggesting it is time to replace the lamp, please install a new lamp or consult your dealer. An old lamp may cause a malfunction in the projector and in some instances the lamp may explode.

For more detailed information on projector warnings, please refer to **"Indicators" on page 47**.

⚠ **The Lamp indicator light and Temperature warning light will light up if the lamp becomes too hot. Turn the power off and let the projector cool for 45 minutes. If the Lamp or Temp indicator still lights up after turning the power back on, please contact your dealer.**

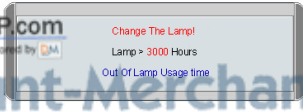
The following Lamp warning displays will remind you to change the lamp.

Message	Status
	The lamp has been in operation for 2800 hours. Install a new lamp for optimal performance. If the projector is normally run with "Economic Mode" selected (See "Economic Mode (off)" on page 38), you may continue to operate the projector until the 2950 hour lamp warning appears.
	The lamp has been in operation for 2950 hours. A new lamp should be fitted to avoid the inconvenience of shutdown when the projector runs out of lamp time.
	The lamp has been in operation for over 3000 hours. This message will flash in the center of the screen for about 30 seconds together with the Lamp indicator lighting up red for 40 seconds.
	If this warning message displays, the projector will shutdown in 40 seconds. The lamp MUST be replaced before the projector will operate normally.

Replacing the lamp

- ⚠ • To reduce the risk of electrical shock, always turn the projector off and disconnect the power cord before changing the lamp.
 - To reduce the risk of severe burns, allow the projector to cool for at least 45 minutes before replacing the lamp.
 - To reduce the risk of injuries to fingers and damage to internal components, use caution when removing lamp glass that has shattered into sharp pieces.
 - To reduce the risk of injuries to fingers and/or compromising image quality by touching the lens, do not touch the empty lamp compartment when the lamp is removed.
 - This lamp contains mercury. Consult your local hazardous waste regulations to dispose of this lamp in a proper manner.
1. Turn the power off and disconnect the projector from the wall socket. If the lamp is hot, avoid burns by waiting for approximately 45 minutes until the lamp has cooled.
 2. Turn the projector over. Then loosen the screw on the lamp cover.

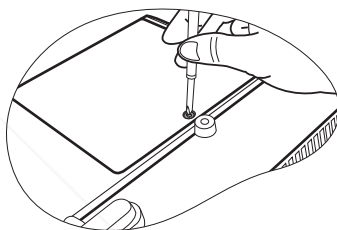

3. Remove the lamp cover from the projector.

⚠ Do not turn the power on with the lamp cover removed.

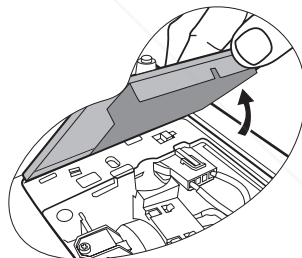

4. Disconnect the lamp connector from the projector.

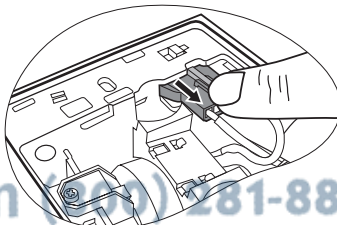

5. Loosen the screw that secures the lamp.

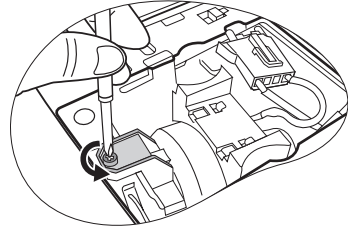

6. Pull the lamp from the projector.



• **Pulling it too quickly may cause the lamp to break and scatter broken glass in the projector.**

• **Do not place the lamp in locations where water might splash on it, children can reach it, or near flammable materials.**

• **Do not insert your hands into the projector after the lamp is removed. If you touch the optical components inside, it could cause color unevenness and distortion of the projected images.**

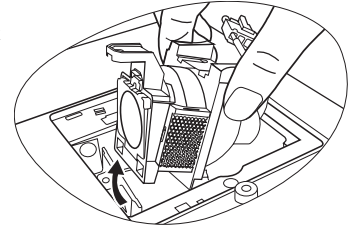

7. As shown in the figure, hold the new lamp and align the two locators on the lamp with the holes on the projector, and then pull the lamp all the way into the projector.

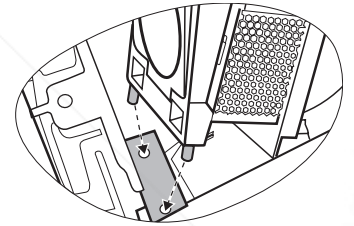

8. Connect the lamp connector to the projector.

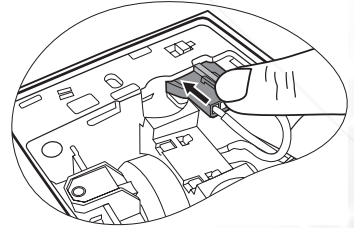

9. Tighten the screw that secures the lamp.



• **Loose screw may cause a bad connection, which could result in malfunction.**

Do not over tighten the screw.

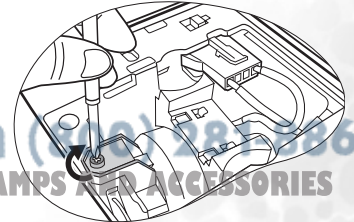

FixYourDLP.com

Sponsored

Do not over tighten the screw.

Discount-Merchant.com (408) 285-2860

THE TRUSTED SOURCE FOR PROJECTOR LAMPS AND ACCESSORIES

10. Replace the lamp cover on the projector.

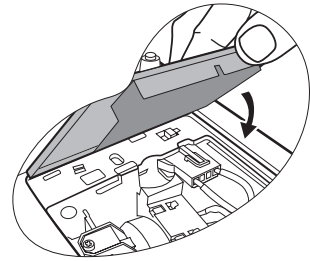

11. Tighten the screw that secures the lamp cover.

- ☞ • **Loose screw may cause a bad connection, which could result in malfunction.**
- **Do not over tighten the screw.**

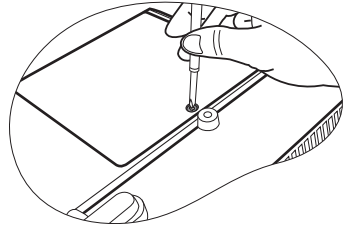

12. Restart the projector.

- ☞ **Do not turn the power on with the lamp cover removed.**

13. **Resetting the lamp counter**

- ☞ **Do not reset if the lamp is not replaced as this could cause damage.**

- i. Press and hold the **Exit** ▲ button on the projector for 5 seconds to display the total used lamp time.
- ii. Press **Auto** on the projector or on the remote control to reset the lamp hour to “0”.
- iii. Wait about 5 seconds to let the OSD disappear.

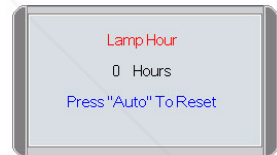

Temperature information

When the Temperature warning light is on, it is warning you of the following possible problems:

1. The internal temperature is too high.
2. The fans are not working.

Turn the projector off and contact qualified service personnel for further help. For more detailed information, please refer to "[Indicators](#)" on page 47.

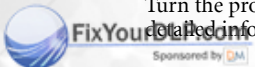











Discount-Merchant.com (800) 281-8860
THE TRUSTED SOURCE FOR PROJECTOR LAMPS AND ACCESSORIES

Indicators

Illustration

- **Blank -** : Light OFF
-  : Light flashing
-  : Light ON
- **O** : Orange light
- **R** : Red light
- **G** : Green light

Light			Status & Description
Power	Temp	Lamp	
Power events			
			The projector has just been connected to a power outlet.
	-	-	Stand-by mode.
	-	-	The Power indicator light is flashing during powering up.
	-	-	The projector is under normal operation.
	-	-	1. The projector needs 90 seconds to cool down as it was abnormally shut down without the normal cooling down process. Or 2. The projector needs to cool for 90 seconds after the power is turned off.
	-	-	The projector has shutdown automatically. If you try to re-start the projector, it will shutdown again. Please contact your dealer for assistance.

Light			Status & Description
Power	Temp	Lamp	
Lamp events			
	-		The projector has shutdown automatically. If you try to re-start the projector, it will shutdown again. Please contact your dealer for assistance.
-	-		1. The projector needs 90 seconds to cool down. Or 2. Please contact your dealer for assistance.



FixYourDIY.com
SOLUTIONS

Discount-Merch.com
THE TRUSTED SOURCE FOR PROJECTOR LAMPS AND ACCESSORIES

Thermal events		
-	R	-
-	R	R
-	R	G
R	R	R
G	R	R
O	R	R
-	G	R

The projector has shutdown automatically. If you try to re-start the projector, it will shutdown again. Please contact your dealer for assistance.

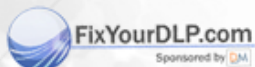

FixYourDLP.com

Sponsored by 

Discount-Merchant.com (800) 281-8860

THE TRUSTED SOURCE FOR PROJECTOR LAMPS AND ACCESSORIES

Safety instructions for ceiling mounting of your BenQ projector

We want you to have a pleasant experience using your BenQ projector, so we need to bring this safety matter to your attention to prevent damage to person and property.

If you intend to mount your projector on the ceiling, we strongly recommend that you use a proper fitting BenQ projector ceiling mount kit and that you ensure it is securely and safely installed.

If you use a non-BenQ brand projector ceiling mount kit, there is a safety risk that the projector may fall from the ceiling due to an improper attachment through the use of the wrong gauge or length screws.

You can purchase a BenQ projector ceiling mount kit from the place you purchased your BenQ projector. BenQ recommends that you also purchase a separate Kensington lock compatible security cable and attach it securely to both the Kensington lock slot on the projector and the base of the ceiling mount bracket. This will perform the secondary role of restraining the projector should its attachment to the mounting bracket become loose.



Discount-Merchant.com (800) 281-8860
THE TRUSTED SOURCE FOR PROJECTOR LAMPS AND ACCESSORIES

7 Troubleshooting

? THE PROJECTOR DOES NOT TURN ON.

Cause	Remedy
There is no power from the power cable.	Plug the power cord into the AC inlet on the projector, and plug the power cord into the power outlet. If the power outlet has a switch, make sure that it is switched on.
Attempting to turn the projector on again during the cooling process.	Wait until the cooling down process has completed.

? NO PICTURE

Cause	Remedy
The video source is not turned on or connected correctly.	Turn the video source on and check that the signal cable is connected correctly.
The projector is not correctly connected to the input source device.	Check the connection.
The input signal has not been correctly selected.	Select the correct input signal with the Source key on the projector or remote control.
The lens cap is still attached to the lens.	Remove the lens cap.

? BLURRED IMAGE

Cause	Remedy
The projection lens is not correctly focused.	Adjust the focus of the lens using the focus ring.
The projector and the screen are not aligned properly.	Adjust the projection angle and direction as well as the height of the unit if necessary.
The lens cap is still attached to the lens.	Remove the lens cap.

? REMOTE CONTROL DOES NOT WORK

Cause	Remedy
The battery is out of power.	Replace the battery with a new one.
There is an obstacle between the remote control and the projector.	Remove the obstacle.
You are too far away from the projector.	Stand within 6 meters (19.5 feet) of the projector.

8 Specifications

Projector specifications

 All specifications are subject to change without notice.

General

Product name	Digital Projector
Model name	MP720

Optical

Resolution	1024 x 768 XGA
Display system	1-CHIP DMD
Lens F/Number	F=2.6 to 2.77, f= 20.4 to 23.5 mm
Lamp	230W lamp

Electrical

Power supply	AC100–240V, 1.5A–3.2A, 50/60 Hz (Automatic)
Power consumption	305W (Max); 10W (Standby)

Mechanical

Dimensions	238 mm (W) x 94 mm (H) x 291 mm (D)
Weight	6 lbs (2.724 Kg)

Input terminal

Computer input	
RGB input	D-sub 15-pin (female) x 1 DVI-I x 1
Video signal input	
S-VIDEO	Mini DIN 4-pin port x 1
VIDEO	RCA jack x1
HDTV signal input	D-sub <--> Component RCA jack x 3, through RGB input
Audio signal input	
Audio in	Mini jack stereo port

Output

RGB output	D-sub 15-pin (female) x 1
USB mouse connector	A/B series x 1
Audio signal output	Mini jack stereo port
Speaker	(mixed mono) 2 watt x 1

Environmental Requirements

Operating temperature	0°C ~ 40°C at sea level
Operating relative humidity	10% ~ 90% (without condensation)
Operating altitude	<ul style="list-style-type: none">• 0–3000 feet at 0°C–40°C• 3000–6000 feet at 0°C–30°C• 6000–10000 feet at 0°C–23°C



FixYourDLP.com

SPORT

Discount Electronics (800) 281-8860

THE TRUSTED SOURCE FOR PROJECTOR PARTS AND ACCESSORIES

Timing chart

Supported timing for PC input

Resolution	Horizontal Frequency (kHz)	Vertical Frequency (Hz)	Pixel Frequency (MHz)	Mode
640 x 400	31.47	70.089	25.176	640 x 400_70
640 x 480	31.469	59.940	25.175	VGA_60
	37.861	72.809	31.500	VGA_72
	37.500	75.000	31.500	VGA_75
	43.269	85.008	36.000	VGA_85
800 x 600	37.879	60.317	40.000	SVGA_60
	48.077	72.188	50.000	SVGA_72
	46.875	75.000	49.500	SVGA_75
	53.674	85.061	56.250	SVGA_85
1024 x 768	48.363	60.004	65.000	XGA_60
	56.476	70.069	75.000	XGA_70
	60.023	75.029	78.750	XGA_75
	68.667	84.997	94.500	XGA_85
1280 x 1024	63.981	60.020	108.000	SXGA_60

Supported timing for Component-YPbPr input

Signal Format	Horizontal Frequency (kHz)	Vertical Frequency (Hz)
480i(525i)@60Hz	15.73	59.94
480p(525p)@60Hz	31.47	59.94
576i(625i)@50Hz	15.63	50.00
576p(625p)@50Hz	31.25	50.00
720p(750p)@60Hz	45.00	60.00
720p(750p)@50Hz	37.50	50.00
1080i(1125i)@60Hz	33.75	60.00
1080i(1125i)@50Hz	28.13	50.00

Supported timing for Video and S-Video inputs

Video mode	Horizontal Frequency (kHz)	Vertical Frequency (Hz)	Color sub-carrier Frequency (MHz)
NTSC	15.73	60	3.58
PAL	15.63	50	4.43
SECAM	15.63	50	4.25 or 4.41
PAL-M	15.73	60	3.58
PAL-N	15.63	50	3.58
PAL-60	15.73	60	4.43
NTSC4.43	15.73	60	4.43

Dimensions

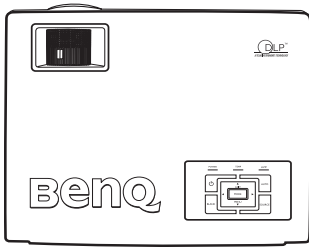

238

291

94

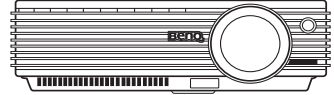

Unit: mm



Discount-Merchant.com (800) 281-8860
THE TRUSTED SOURCE FOR PROJECTOR LAMPS AND ACCESSORIES

Warranty

Limited Warranty

BenQ warrants this product against any defects in material and workmanship, under normal usage and storage.

Proof of purchase date will be required with any warranty claim. In the event this product is found to be defective within the warranty period, BenQ's only obligation and your exclusive remedy shall be replacement of any defective parts (labor included). To obtain warranty service, immediately notify the dealer from which you purchased the product of any defects.

Important: The above warranty shall be void if the customer fails to operate the product in accordance with BenQ's written instructions, especially the ambient humidity must be in-between 10% and 90%, temperature in-between 0°C and 40°C, altitude lower than 10000 feet, and avoiding to operate the projector in a dusty environment. This warranty gives you specific legal rights, and you may have other rights which vary from country to country.

For other information, please visit www.BenQ.com.

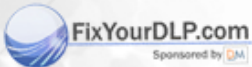

Discount-Merchant.com (800) 281-8860
THE TRUSTED SOURCE FOR PROJECTOR LAMPS AND ACCESSORIES

10 Regulation Statements

FCC statement

CLASS B: This equipment generates, uses and can radiate radio frequency energy and, if not installed and used in accordance with the instructions, may cause harmful interference to radio communications. However, there is no guarantee that interference will not occur in a particular installation. If this equipment does cause harmful interference to radio or television reception, which can be determined by turning the equipment off and on, the user is encouraged to try to correct the interference by one or more of the following measures:

- Reorient or relocate the receiving antenna.
- Increase the distance between the equipment and receiver.
- Connect the equipment into an outlet on a circuit different from that to which the receiver is connected.
- Consult the dealer or an experienced radio/TV technician for help.

EEC statement

This machine was tested against the 89/336/EEC (European Economic Community) for EMC (Electronic Magnetic Compatibility) and fulfills these requirements.

MIC statement

B class equipment (Household purpose info/telecommunications equipment)

As this equipment has undergone EMC registration for household purpose, this product can be used in any area including residential area.

WEEE directive

Disposal of Waste Electrical and Electronic Equipment by users in private households in the European Union.

This symbol on the product or on the packaging indicates that this can not be disposed of as household waste. You must dispose of your waste equipment by handling it over to the applicable take-back scheme for the recycling of electrical and electronic equipment. For more information about recycling of this equipment, please contact your city office, the shop where you purchased the equipment or your household waste disposal service. The recycling of materials will help to conserve natural resources and ensure that it is recycled in a manner that protects human health and environment.



Discount-Merchant.com (800) 281-8860
THE TRUSTED SOURCE FOR PROJECTOR LAMPS AND ACCESSORIES



Disclaimer

This user manual is provided as a free service by FixYourDLP.com. FixYourDLP is in no way responsible for the content of this manual, nor do we guarantee its accuracy. FixYourDLP does not make any claim of copyright and all copyrights remain the property of their respective owners.

About FixYourDLP.com

FixYourDLP.com (<http://www.fixyourdpl.com>) is the World's #1 resource for media product news, reviews, do-it-yourself guides, and manuals.

Informational Blog: <http://www.fixyourdpl.com>

Video Guides: <http://www.fixyourdpl.com/guides>

User Forums: <http://www.fixyourdpl.com/forum>

FixYourDLP's Fight Against Counterfeit Lamps:

<http://www.fixyourdpl.com/counterfeits>

Sponsors:

RecycleYourLamp.org – Free lamp recycling services for used lamps:

<http://www.recycleyourlamp.org>

Lamp Research - The trusted 3rd party lamp research company:

<http://www.lampresearch.com>

Discount-Merchant.com – The worlds largest lamp distributor:

<http://www.discount-merchant.com>



FixYourDLP.com

Sponsored by 