



# Disclaimer

This user manual is provided as a free service by FixYourDLP.com. FixYourDLP is in no way responsible for the content of this manual, nor do we guarantee its accuracy. FixYourDLP does not make any claim of copyright and all copyrights remain the property of their respective owners.

About FixYourDLP.com

FixYourDLP.com (<http://www.fixyourdlp.com>) is the World's #1 resource for media product news, reviews, do-it-yourself guides, and manuals.

Informational Blog: <http://www.fixyourdlp.com>

Video Guides: <http://www.fixyourdlp.com/guides>

User Forums: <http://www.fixyourdlp.com/forum>

FixYourDLP's Fight Against Counterfeit Lamps:

<http://www.fixyourdlp.com/counterfeits>

## Sponsors:

RecycleYourLamp.org – Free lamp recycling services for used lamps:

<http://www.recycleyourlamp.org>

Lamp Research - The trusted 3rd party lamp research company:

<http://www.lampresearch.com>

Discount-Merchant.com – The worlds largest lamp distributor:

<http://www.discount-merchant.com>



**FixYourDLP.com**

Sponsored by 

# C100 / C90



English  
Deutsch  
Français  
Español  
Italiano  
Português

 FixYourDLP.com  
Sponsored by 

**Discount-Merchant.com (800) 221-2860** Norsk  
THE TRUSTED SOURCE FOR PROJECTOR LAMPS AND ACCESSORIES



<b>A. SUPPLIED MATERIAL.....4</b>	<b>H. OVERVIEW / CEILING MOUNT.....19</b>
LIEFERUMFANG	ÜBERSICHT / DECKENMONTAGESATZ
EQUIPEMENT FOURNI	PRESENTATION / MONTAGE AU PLAFOND
MATERIAL SUMINISTRADO	VISTA GENERAL / MONTAJE EN EL TECHO
MATERIALE FORNITO	PROSPETTO / MONTATURA PER IL SOFFITTO
MATERIAL FORNECIDO	VISTA GERAL / SUPORTE DE TETO
VEDLAGT MATERIELL	OVERSIKT / TAKMONTASJE
<b>B. SETTING UP PROCEDURE.....6</b>	<b>I. LIGHT MESSAGES.....20</b>
ANSCHLUSS	LEUCHTANZEIGEN
INSTALLATION	INDICATEURS LUMINEUX
PROCEDIMIENTO DE CONEXIÓN	INDICADORES LUMINOSOS
PROCEDIMENTO DI IMPOSTAZIONE	MESSAGGI LUMINOSI
INSTALAÇÃO	INDICADORES LUMINOSOS
OPPSETT	LYSSIGNALER
<b>C. START - STOP.....8</b>	<b>J. POWER MANAGEMENT (DPMS).....22</b>
START - STOP	POWER MANAGEMENT (DPMS)
MISE EN/HORS SERVICE	GESTION DE L'ALIMENTATION (DPMS)
ENCENDIDO - APAGADO	FUENTES DE ENERGIA (DPMS)
AVVIO - ARRESTO	CONTROLLO DELL'OPERATIVITÀ (DPMS)
LIGAR - DESLIGAR	CONTROLE DA POTÊNCIA
START - STOPP	STRØMSPARING (DPMS)
<b>D. IMAGE ADJUSTMENTS.....9</b>	<b>K. TROUBLESHOOTING.....23</b>
BILDEINSTELLUNGEN	FEHLERBEHEBUNG
MISE AU POINT DE L'IMAGE	SOLUTION AUX PROBLÈMES LES PLUS
AJUSTE DE LA IMAGEN	FREQUENTS
REGOLAZIONE DELL'IMMAGINE	SOLUCIÓN DE PROBLEMAS
AJUSTES DA IMAGEM	SOLUZIONE DEI PROBLEMI
JUSTERE BILDET	LOCALIZAÇÃO DE DEFEITOS
<b>E. REMOTE CONTROL &amp; KEYBOARD.....10</b>	FEILSØKING
FERNBEDIENUNG UND BEDIENFELD	<b>L. TECHNICAL DATA.....25</b>
TELECOMMANDE ET CLAVIER	TECHNISCHE DATEN
CONTROL REMOTO Y TECLADO	CARACTERISTIQUES TECHNIQUES
TELECOMANDO E TASTIERA	DATOS TÉCNICOS
CONTROLE REMOTO E TECLADO	DATI TECNICI
FJERNKONTROLL OG TASTATUR	DADOS TÉCNICOS
<b>F. MENU ADJUSTMENTS.....13</b>	TEKNISKE DATA
MENÜ EINSTELLUNGEN	<b>M. SERVICE INFORMATION.....28</b>
OPTIONS DE MENU	SERVICEHINWEIS
MENÚ DE AJUSTES	RÉPARATIONS
IMPOSTAZIONI DAL MENU	INFORMACIÓN SOBRE ASISTENCIA TECNICA
AJUSTES DO MENU	ASSISTENZA TECNICA
MENYINNSTILLINGER	INFORMAÇÃO DE SERVICOS
<b>G. CONTROL RS 232.....18</b>	SERVICEINFORMASJON
STEUERN SIE RS 232	<b>N. MAINTENANCE.....29</b>
CONTROLLES DES RS 232	WARTUNG
CONTROLE RS 232	ENTRIEN
GESTIRE RS 232	MANTENIMIENTO
CONTROLE RS 232	MANUTENZIONE
KONTROLL RS 232	MANUTENÇÃO
	VEDLIKEHOLD
	<b>O. FCC STATEMENT.....31</b>

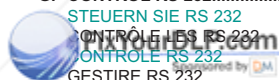

Discount-Merchant.com (800) 281-8860

THE TRUSTED SOURCE FOR PROJECTOR LAMPS AND ACCESSORIES

# A SUPPLIED MATERIAL \*)

LIEFERUMFANG EQUIPEMENT FOURNI MATERIAL SUMINISTRADO MATERIALE FORNITO MATERIAL FORNECIDO VEDLAGT MATERIELL

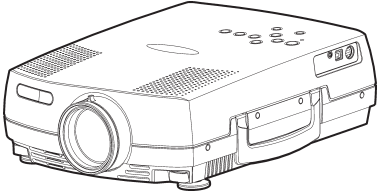

LCD Projector with lenscap  
 LCD Projektor mit Schutzkappe  
 Projecteur LCD avec protection lentille  
 Projector LCD con tapa del lente  
 Proiettore LCD con coperchietto  
 Projektor LCD com protetor de lente  
 LCD-projektor med linsedeksel

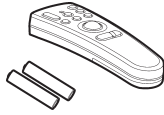

Remote control with batteries  
 Fernbedienung mit Batterien  
 Télécommande avec batteries  
 Control remoto con pilas  
 Telecomando con batterie  
 Controle remoto com pilhas  
 Fjernkontroll med batterier

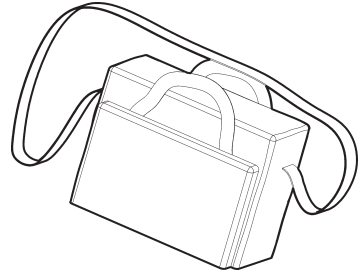

Soft Case  
 Tragetasche  
 Etui souple  
 Funda  
 Valigetta  
 Maleta  
 Myk veske

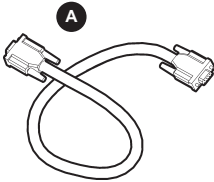

Analog Computer Cable (VGA)  
 Analogkabel (VGA)  
 Câble ordinateur analogique (VGA)  
 Cable para ordenador analógico (VGA)  
 Cavo analogico per il computer (VGA)  
 Cabo de Computador Analógico (VGA)  
 Analog Datamaskinkabel (VGA)

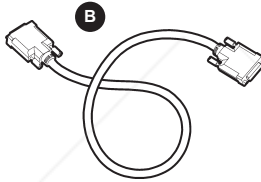

Digital Computer Cable (DVI)  
 Digitalkabel (DVI)  
 Câble ordinateur digital (DVI)  
 Cable para ordenador digital (DVI)  
 Cavo digitale per il computer (DVI)  
 Cabo de Computador Digital (DVI)  
 Digital Datamaskinkabel (DVI)

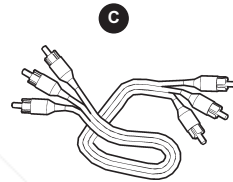

Audio/Video Cable  
 Audio/Videokabel  
 Câble audio/vidéo  
 Conexión de audio/vidéo  
 Cavo audio/vidéo  
 Cabo de Áudio/Video  
 Audio/Videokabel

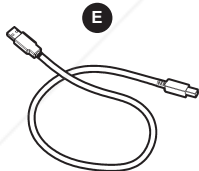

USB Mouse Cable by DM  
 USB Maus kabel  
 Câble souris USB  
 Cable raton USB  
 Cavo mouse USB  
 Cabo de Mouse USB  
 USB-musekabel

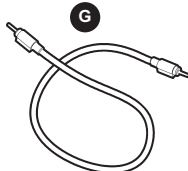

Audio Cable  
 Audiokabel  
 Câble audio  
 Cable de audio  
 Cavo audio  
 Cabo de Audio  
 Audiokabel

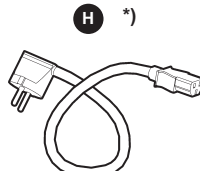

Power cord  
 Netzkabel  
 Cordon d'alimentation  
 Cable de alimentación  
 Cavo alimentazione  
 Cabo de alimentação  
 Strömledning



SCART adapter  
 SCART-Anschluss  
 Adaptateur audio  
 Adaptador de Scanner  
 Presa scart  
 Adaptador SCART  
 SCART-adapter



FixYourDLP.com

Discount-Merchant.com (800) 451-8860  
 THE TRUSTED SOURCE FOR PROJECTOR LAMP AND ACCESSORIES

\*) Country dependent Länder abhängig Dépendant du pays Dependence del país Dipendentemente al paese di destinazione Dependendo do país Områdeavhengig

F



Mouse Cable  
 Mauskabel  
 Câble souris  
 Cable raton  
 Cavo mouse  
 Cabo de Mouse  
 Musekabel

F1



PS/2 mouse adapter  
 PS/2 Adapter der Maus  
 PS/2 Adaptateur de la souris  
 PS/2 Adaptador del ratón  
 PS/2 Adattotore del mouse  
 PS/2 Adaptador do rato  
 PS/2 Musadapter

F2



Serial PC mouse adapter  
 Serien PC Mausadapter  
 Adaptateur séquentiel de souris de PC  
 Adaptador serial del ratón de la PC  
 Adattatore seriale del mouse del PC  
 Adaptador de série do rato do PC  
 Serie PC Musadapter

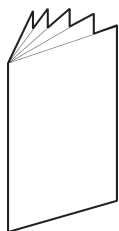

User guide  
 Benutzer Handbuch  
 Guide d'utilisateur  
 Guía del usuario  
 Manuale d'uso  
 Guia do usuário  
 Bruker veiledning



**Discount-Merchant.com (800) 281-8860**  
**THE TRUSTED SOURCE FOR PROJECTOR LAMPS AND ACCESSORIES**

\*) Country dependent Länder abhängig Dépendant du pays Dependente del país Dipendentemente al paese di destinazione Dependendo do país Områdeavhengig

1. Connect the projector to:
  - the data source with the Analog Computer Cable (A) to ANALOG COMPUTER VGA (2) or
  - the data source with the Digital Computer Cable (B) to DIGITAL COMPUTER DVI (1)
  - the video source with the Video Cable (C) to VIDEO/AUDIO IN
  - the video source with the S-Video Cable (optional) (D) to S-VIDEO
2. For the mouse control connect:
  - the USB Mouse Cable (E) to MOUSE 2 (USB), when using DIGITAL COMPUTER DVI (1) or ANALOG COMPUTER VGA (2)
  - the Mouse Cable (F) to MOUSE 1 with appropriate adapter (F1 or F2), when using ANALOG COMPUTER VGA (3)
3. For computer sound connection, use:
4. Connect power cord to projector (H)
5. Turn on the projector, then the source(s)

1. Projektör anschließen:
  - mit dem Analogkabel (A) an ANALOG COMPUTER VGA (2) (Datenquelle) oder
  - mit dem Digitalkabel (B) an DIGITAL COMPUTER DVI (1) (Datenquelle)
  - mit Videokabel (C) an VIDEO/AUDIO IN (Videoquelle)
  - mit S-Video-kabel (optional) (D) an S-VIDEO (Videoquelle)
2. Für Maussteuerung:
  - das USB-Mauskabel (E) in den Anschluss MOUSE 2 stecken, nur bei DIGITAL COMPUTER DVI (1) oder ANALOG COMPUTER VGA (2)
  - Mauskabel (F) mit passendem Adapter (F1 oder F2) an MOUSE 1 anschließen, nur bei ANALOG COMPUTER (3)
3. Für Klang aus dem Computer das Audiokabel (G) in den Anschluss AUDIO IN stecken
4. Netzstecker des Projektors einstecken (H)
5. Zuerst Projektör und dann Quellgerät(e) einschalten

1. Connectez le projecteur à:
  - la source de donnée avec le Câble ordinateur analogique (VGA) (A) à la ANALOG COMPUTER VGA (2)
  - la source de donnée avec le Câble ordinateur digital (DVI) (B) à la DIGITAL COMPUTER DVI (1)
  - la source vidéo avec le Câble video (C) à la prise VIDEO IN/AUDIO IN
  - la source vidéo avec le Câble S-Video (en option) (D) à la prise S-VIDEO
2. Pour travailler avec la souris, connectez:
  - le câble souris USB (E) à MOUSE 2, uniquement avec un DIGITAL COMPUTER DVI (1) ou un ANALOG COMPUTER VGA (2)
  - le Câble (F) de la souris à MOUSE 1 avec un adaptateur adéquat (F1 ou F2), uniquement avec un ANALOG COMPUTER VGA (3)
3. Pour la connexion au son de l'ordinateur, reliez le Câble audio (G) à AUDIO IN
4. Branchez le cordon d'alimentation sur le projecteur (H)
5. Allumez d'abord le projecteur, puis la (les) source(s).

1. Conectar el proyector a:
  - la fuente de datos conectando el cable para ordenador analógico (A) al ANALOG COMPUTER VGA (2) o
  - la fuente de datos conectando el cable para ordenador digital (B) al DIGITAL COMPUTER DVI (1)
  - la fuente de vídeo conectando el cable de vídeo (C) a la entrada VIDEO/AUDIO IN
  - la fuente de vídeo conectando el cable de VIDEO S (opcional) (D) al S-VIDEO
2. Para el control del ratón, conecte:
  - el Cable de ratón USB (E) al MOUSE 2, solamente con el DIGITAL COMPUTER DVI (1) o con el ANALOG COMPUTER VGA (2)
  - el Cable del Ratón (F) a MOUSE 1 con el adaptador apropiado (F1 ó F2), solamente con el ANALOG COMPUTER VGA (3)
3. Para conectar el sonido del ordenador, conecte el cable de audio (G) a la entrada AUDIO IN
4. Conectar el cable de alimentación al proyector (H)
5. Poner en marcha el proyector, luego la(s) fuente(s)

1. Collegare il proiettore:
  - alla sorgente dei dati con il cavo analogico per computer (A) al ANALOG COMPUTER VGA (2) o
  - alla sorgente dei dati con il cavo digitale per computer (B) al DIGITAL COMPUTER DVI (1)
  - Alla sorgente video con il cavo video (C) sulla presa VIDEO IN/AUDIO IN
  - Alla sorgente video con il cavo S-Video (opzionale) (D) sulla presa S-VIDEO
2. Per il controllo del mouse collegare:
  - il cavo USB del mouse (E) collegato a MOUSE 2, solo con DIGITAL COMPUTER DVI (1) o ANALOG COMPUTER VGA (2)
  - il Cavo del Mouse (F) a MOUSE 1 con l'apposito adattatore (F1 o F2), solo con ANALOG COMPUTER VGA (3)
3. Per il collegamento audio con il computer, usare il cavo audio (G) collegato a AUDIO IN
4. Collegare il cavo di alimentazione al proiettore (H)
5. Accendere prima il proiettore e poi la/sorgente/i

1. Conecte o projetar à:
  - fonte de dados com o Cabo de Computador Analógico (A) em ANALOG COMPUTER VGA (2) ou
  - fonte de dados com o Cabo de Computador Digital (B) em DIGITAL COMPUTER DVI (1)
  - fonte de vídeo com o Cabo de Vídeo (C) em VIDEO IN/AUDIO IN
  - fonte de vídeo com o Cabo de S-Video (opcional) (D) em S-VIDEO
2. Para o controle do rato ligue:
  - o cabo USB do mouse (E) a MOUSE 2 (USB), somente com DIGITAL COMPUTER DVI (1) ou ANALOG COMPUTER VGA (2)
  - o Cabo do Rato (F) a MOUSE 1 com o adaptador adequado (F1 ou F2), somente com ANALOG COMPUTER VGA (3)
3. Para a conexão do computador, use o Cabo de Áudio (G) em AUDIO IN
4. Conecta o cabo de alimentação no projetor (H)
5. Ligue o projetor, depois a(s) fonte(s)

1. Koble projektoren til:
  - datakilden med den analoge datamaskinkabelen (A) til ANALOG COMPUTER VGA (2) eller
  - datakilden med den digitale datamaskinkabelen (B) til DIGITAL COMPUTER DVI (1)
  - videokilden med videokabelen (C) til VIDEO / AUDIO IN
  - videokilden med S-VIDEO-kabelen (valgfritt) (D) til S-VIDEO
2. Muskontroll kobles til:
  - med USB-muskabelen (E) til MOUSE 2 (USB), bare med DIGITAL COMPUTER DVI (1) eller ANALOG COMPUTER VGA (2)
  - med Musekabel (F) til MOUSE 1 med korrekt adapter (F1 eller F2), bare med ANALOG COMPUTER VGA (3)
3. Lyd fra datamaskinen kobles til med audiokabelen (G) til AUDIO IN
4. Koble strømledningen til projektoren (H)
5. Slå på projektoren, og deretter kilden(e)

# SETTING UP PROCEDURE

ANSCHLUSS INSTALLATION PROCEDIMIENTO DE CONEXIÓN PROCEDIMENTO DI IMPOSTAZIONE INSTALACÃO OPPSETT

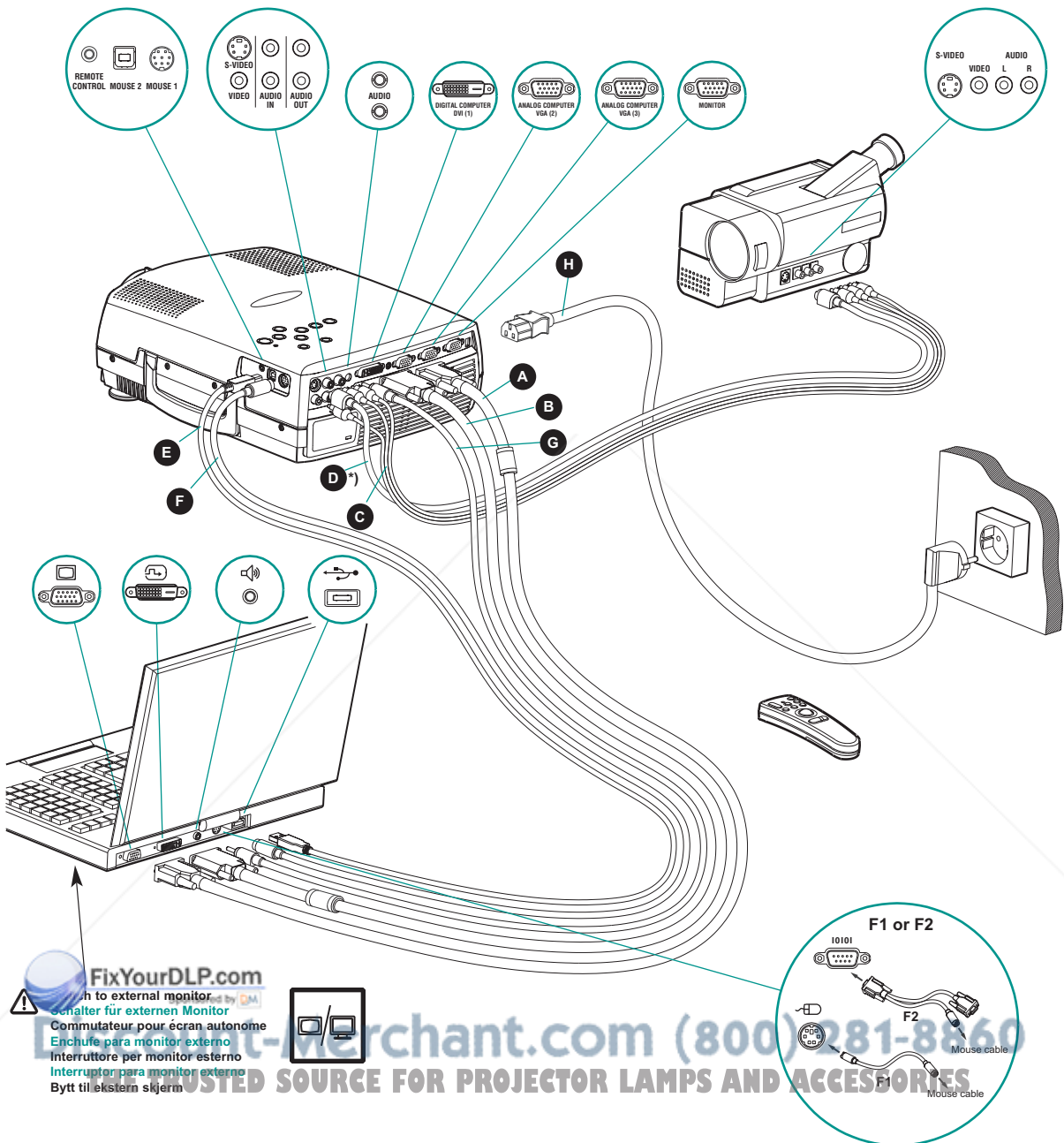



**FixYourDLP.com**  
 Switch to external monitor  
 Schalter für externen Monitor  
 Commutateur pour écran autonome  
 Enchufe para monitor externo  
 Interruttore per monitor esterno  
 Interruptor para monitor externo  
 Bytt til ekstern skjerm

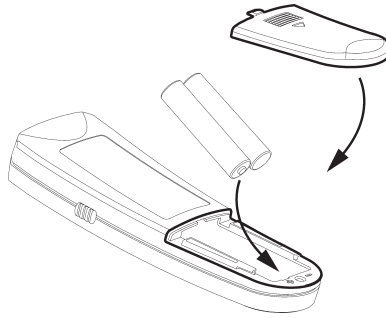

\*) Optional equipment Zusatzausstattung Equipment optionnel Equipamiento opcional Componenti optional Equipamento opcional Tilleggsutstyr

Install batteries  
 Batterien einlegen  
 Mettre des piles en place  
 Colocar las baterías  
 Inserimento pile  
 Colocar as pilhas  
 Sett inn batteriene



Switch ON to operate remote control  
 Auf ON stellen, um die Fernbedienung einzuschalten  
 Mettez sur position ON pour utiliser la télécommande  
 Poner el conmutador en ON para activar el control remoto  
 Posizionare su ON per attivare il telecomando  
 Coloque em on para ligar o controle remoto  
 Trykk på ON for å slå på fjernkontrollen

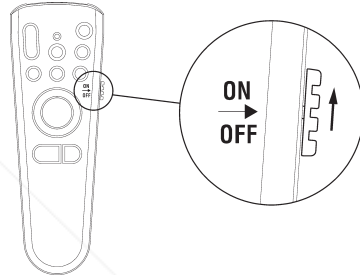

1

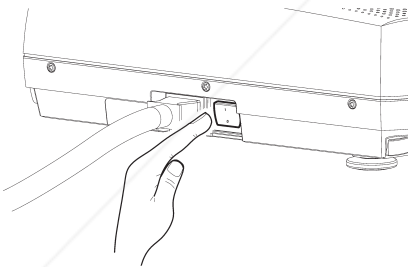

2



FixYourDLP.com

Sponsored by

Discount-Merchant.com (800) 281-8860  
 THE TRUSTED SOURCE FOR PROJECTOR LAMPS AND ACCESSORIES

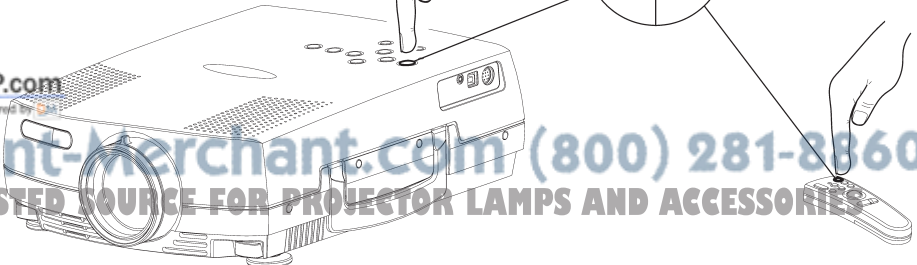



# D IMAGE ADJUSTMENT

BILDESTELLUNG MISE AU POINT DE L'IMAGE ADJUSTE DE LA IMAGEN REGOLAZIONE ELL'IMMAGINE ADJUSTES DA IMAGEM JUSTERE BILDET

1

Zoom: adjust picture size  
Zoom: Einstellen der Bildgröße  
Zoom: règle les dimensions de l'image  
Zoom: ajusta el tamaño de la imagen  
Zoom: regola le dimensioni dell'immagine  
Zoom: ajusta o tamanho da imagem  
Zoom: justerer bildets størrelse

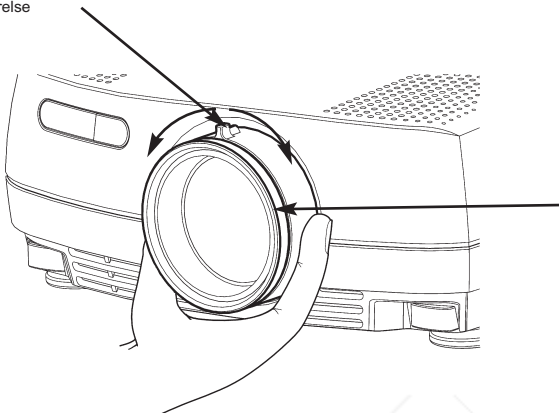

2

Focus: adjusts picture clearness  
Focus: Einstellen der Bildschärfe  
Focus: règle la netteté de l'image  
Focus: ajusta la claridad de la imagen  
Focus: regola la messa a fuoco dell'immagine  
Focus: ajusta a nitidez da imagem  
Fokus: justerer bildets skarphet

1

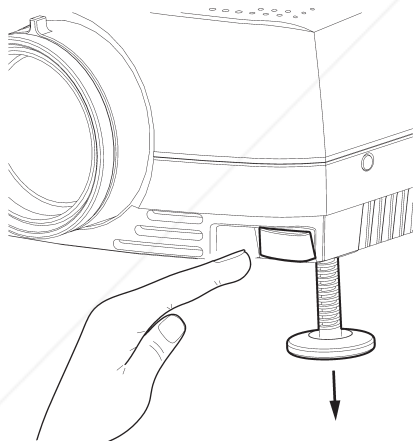

2

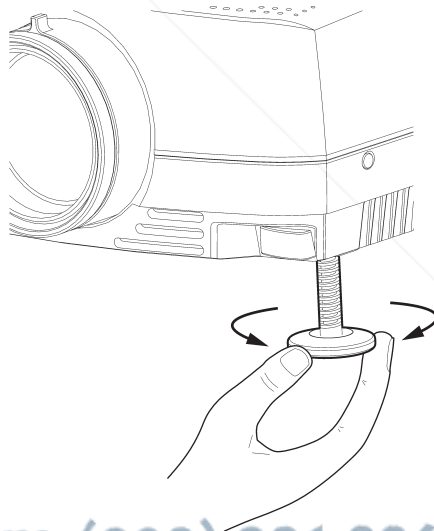

Release projector feet to adjust display angle (1) or manually adjust feet (2)

Fuß zur Einstellung des Projektionswinkels lösen (1) oder drehen (2)

Libère les pieds du projecteur pour régler l'angle de projection (1) ou régler les pieds manuellement (2)

Liberar la pata del proyector para ajustar el ángulo de presentación de imagen (1) o ajustar la pata manualmente (2)

Sblocca i piedi del proiettore per regolare l'angolazione dello schermo (1) o per regolare manualmente l'altezza dei piedi (2)

Solte os pés do projetor para ajustar o ângulo de exibição (1) ou ajuste os pés manualmente (2)

Frigjør projektorens føtter for a justere visningsvinkelen (1), eller justere føttene manuelt (2)

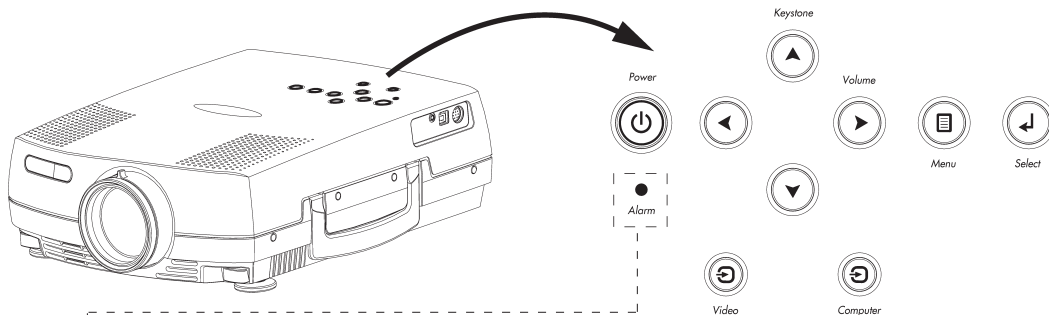

Alarm

RED light indicates lamp replacement required. Ref. N (MAINTENANCE)  
 Das ROTE Licht zeigt an, daß die Lampe ausgewechselt werden muß. Ref. N (WARTUNG)  
 La lumière ROUGE indique que la lampe doit être remplacée. Ref. N (MAINTENANCE)  
 La luz ROJA indica que se debe de reemplazar la bombilla. Ref. N (MANTENIMIENTO)  
 La luce ROSA indica che bisogna sostituire la lampadina. Rif. N (MANUTENZIONE)  
 A luz VERMELHA indica que a lâmpada deve ser substituída. Ref. N (MANUTENÇÃO)  
 RØDT lys angir at lampen må byttes ut. Se kap. N (VEDLIKEHOLD)



Alarm

RED FLASHING when the projector is overheated. Power off and let cool down  
 ROTES BLINKLICHT zeigt Überhitzung des Projektors an. Ausschalten und abkühlen lassen  
 Un CLIGNOTEMENT ROUGE signale la surchauffe du projecteur. Débrancher l'alimentation et laisser refroidir  
 LUZ ROJA PARPADEANTE cuando el proyector está sobrecalentado. Desconectar la alimentación y dejar enfriar  
 La luce ROSSA INTERMITTENTE indica che il proiettore si è surriscaldato. Scollegare l'alimentazione e lasciare raffreddare  
 A luz VERMELHA intermitente indica superaquecimento do projector. Desligar e deixar esfriar  
 RØDT BLINKENDE når når projektoren er overopphetet. Slå av og la projektoren avkjøle seg

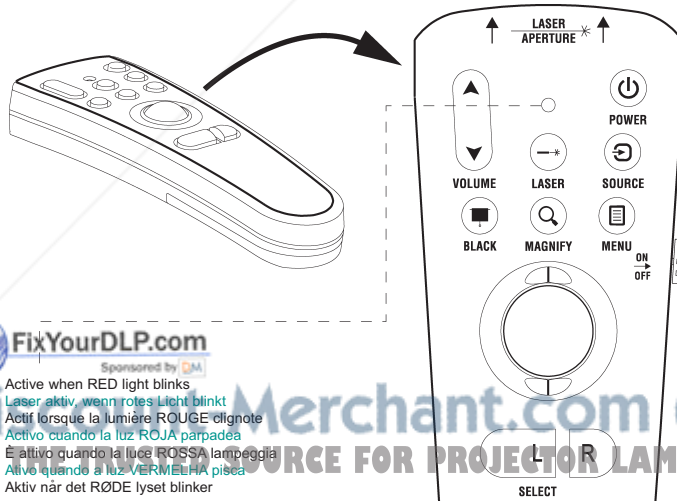

FixYourDLP.com

Sponsored by DM

Active when RED light blinks

Laser aktiv, wenn rotes Licht blinkt

Actif lorsque la lumière ROUGE clignote

Activo cuando la luz ROJA parpadea

È attivo quando la luce ROSSA lampeggia

Ativo quando a luz VERMELHA pisca

Aktiv når det RØDE lyset blinker

DirectLink Merchant.com (800) 281-8860  
 DIRECT LINK SOURCE FOR PROJECTOR LAMPS AND ACCESSORIES

- Activate by pressing actual key(s).
- Zum Aktivieren jeweilige Taste(n) drücken.
- Aktiver en pressant la (les) touches correspondante(s).
- Activar pulsando la(s) tecla(s) indicativa(s).
- Attivare premendo il / i tasto / i attivi.
- Ativar pressionando a(s) tecla(s) correspondante(s).
- Aktiver ved å trykke på aktuell(e) tast(er).

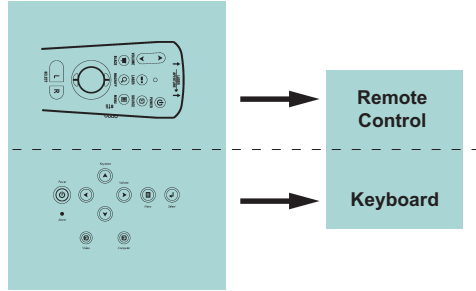

Turns the projector ON/OFF  
 Projektor ein-/ausschalten  
 Allume (ON)/Eteint (OFF) le projecteur  
 Encender (ON)/Apagar (OFF) el proyector  
 Accensione del proiettore ON/OFF  
 Liga e Desliga o projetor  
 Slår projektoren PÅ/AV

Adjust volume  
 Lautstärke einstellen  
 Régler le volume  
 Ajustar el volumen  
 Regolazione del volume  
 Ajusta o volume  
 Juster lydstyrken

Blackens the projected image  
 Bild verdunkeln  
 Assombrir l'image  
 Bajar la imagen proyectada a negro  
 Oscuramento dell'immagine proiettata  
 Preteja a imagem projetada  
 Gjør bildet som vises sort

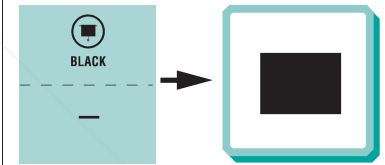
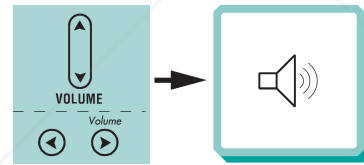
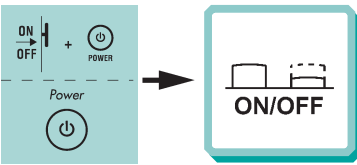

Adjust keystone angle  
 Winkel Trapezverzerrung einstellen  
 Régler de l'angle de la clef de voûte  
 Ajustar el ángulo de distorsión de imagen  
 Regolazione dell'angolo di distorsione  
 Ajusta o ângulo trapezoidal  
 Juster keystone-vinkelen

Switch between connected sources  
 Zwischen angeschlossenen Geräten hin- und herschalten.  
 Passage d'une source connectée à une autre source connectée.  
 Conmutar entre las fuentes conectadas  
 Commutazione fra le sorgenti collegate  
 Alterna entre as fontes conectadas  
 Bytt mellom de tilkoblede kildene

Activates/deactivates on screen menu (OSD)  
 Bildschirmmenü aktivieren/deaktivieren (OSD)  
 Active/Désactive le menu sur l'écran (OSD)  
 Activa/desactiva el menú en pantalla  
 Attivazione/disattivazione del menù sullo schermo  
 Ativa/desativa o menu da tela  
 Aktiverer/deaktiverer menyvisning på skjermen (OSD)

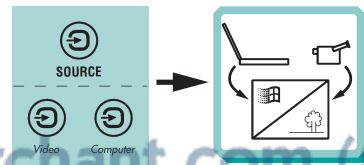

Discount-Merchant.com (800) 281-8860

THE TRUSTED SOURCE FOR PROJECTOR LAMPS AND ACCESSORIES

Scroll menu  
 Menüpunkte ansteuern  
 Menu déroulant  
 Desplegar menú  
 Scorrimento del menù  
 Desloque-se no menu  
 Gå gjennom menyen

Select on-screen menu function  
 Funktion des Bildschirmmenüs aktivieren  
 Sélectionnez une fonction du menu sur l'écran  
 Seleccionar función de menú en pantalla  
 Selezione della funzione sul menù dello schermo  
 Selezione uma função no menu da tela  
 Velg aktuell funksjon i menyen på skjermen

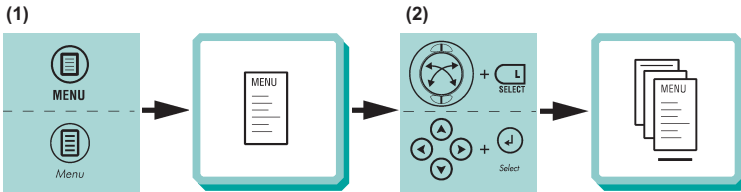

Press to zoom into picture  
 Drücken, um Bild zu vergrößern  
 Cliquez dans l'image pour faire un zoom  
 Pulse para acercar la imagen  
 Premere per ingrandire l'immagine  
 Pressione para efetuar o "zoom" da imagem  
 Press for å forstørre bildet

Press to pan  
 Drücken, um zu panoramisieren  
 Cliquez pour faire un panoramique  
 Pulse para panorámica  
 Premere per una panoramica  
 Pressione para "pan"  
 Press for å bevege bildet

Reset picture to full size  
 Zurück zur Originalgröße  
 Retour de l'image à ses dimensions  
 Restablecer la imagen a tamaño completo  
 Ripristino dell'immagine all dimensioni massime.  
 Reajuste a imagem a seu tamanho máximo.  
 Tilbakestill bildet til full størrelse

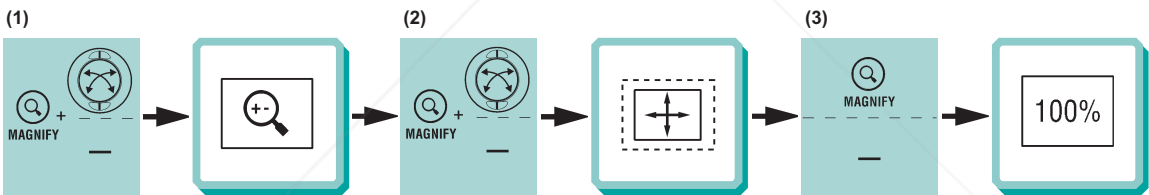

Laser pointer  
 Laserzeiger  
 Indicateur laser  
 Puntero láser  
 Puntatore laser  
 Apontador laser  
 Laserpeker

Mouse control  
 Steuerung per Maus  
 Contrôle souris  
 Control del ratón  
 Controllo del mouse  
 Controle do mouse  
 Musekontrol

FixYourDLP.com  
 Sponsored by DM

DiscountMerch.com (800) 281-8860  
 THE TRUSTED SOURCE FOR PROJECTOR LAMPS AND ACCESSORIES

Activate/deactivate by:  
 Aktivieren/Deaktivieren mit:  
 Activer et désactiver à l'aide:  
 Activar/desactivar pulsando:  
 Attivare/disattivare premendo:  
 Ativa/Desativa com:  
 Aktiver/deaktiver med:



Navigate by:  
 Steuern mit:  
 Pour naviguer:  
 Navegar pulsando:  
 Spostasi premendo:  
 Navegar com:  
 Naviger med:



Choose function with:  
 Funktion wählen mit:  
 Choisissez la fonction avec:  
 Seleccionar función con:  
 Scegliere la funzione:  
 Escolha a função:  
 Velg funksjon med:



1.0

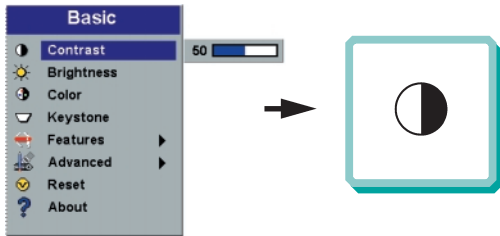

Adjusts contrast range from 0-100  
 Kontrast von 0-100 einstellen  
 Règle le contraste entre 0 et 100  
 Ajusta el contraste entre 0-100  
 Regolazione del contrasto da 0 a 100  
 Ajusta o contraste de 0 a 100  
 Justerer kontrasten innenfor området 0-100

4.0

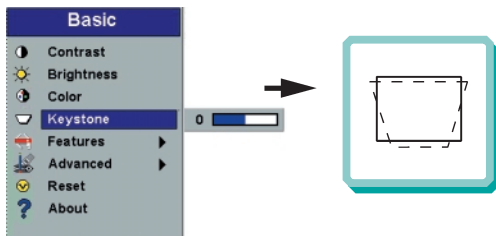

Adjust keystone from -63 to +64  
 Trapezentzerrung von -63 bis +64 einstellen  
 Règle la clé de voûte -63 et +64  
 Ajusta la distorsión de imagen desde -63 a +64  
 Regolazione della distorsione da -63 a +64  
 Ajusta o ângulo trapezoidal de -63 a +64  
 Justerer keystone-funksjonen fra -63 til +64

2.0

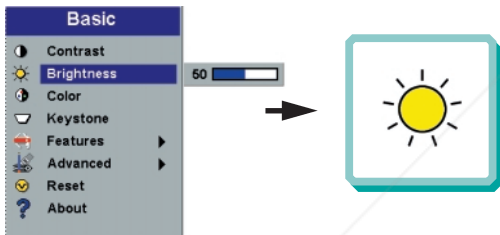

Adjusts brightness range from 0-100  
 Helligkeit von 0-100 einstellen  
 Règle la luminosité entre 0 et 100  
 Ajusta el brillo entre 0-100  
 Regolazione della luminosità da 0 a 100  
 Ajusta o brilho de 0 a 100  
 Justerer lysstyrken innenfor området 0-100

5.0

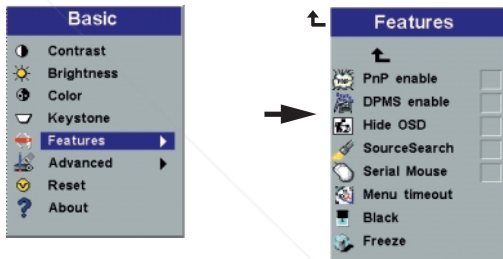

3.0

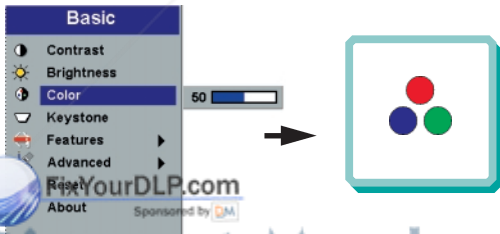

Adjusts colour intensity in video images from 0-100  
 Farbintensität von Videobildern von 0-100 einstellen  
 Règle l'intensité de la couleur des images vidéo entre 0 et 100  
 Ajusta la intensidad del color de la imagen video entre 0-100  
 Regolazione dell'intensità del colore da 0 a 100 nelle immagini video  
 Ajusta a intensidade da cor em imagens de vídeo de 0 a 100  
 Justerer fargeintensiteten til videobilder fra 0-100

5.1

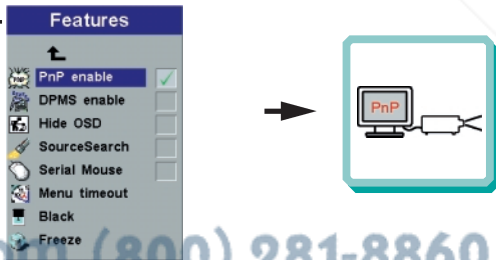

Select plug and play active/inactive  
 Plug and Play aktivieren/deaktivieren  
 Sélection "plug and play" actif/inactif  
 Selecciona activar/desactivar "plug & play" (enchufar y jugar)  
 Selezione del Plug & Play attivo/inattivo  
 Selecciona plug and play ativo/inativo  
 Velg om plug and play skal være aktiv/inaktiv

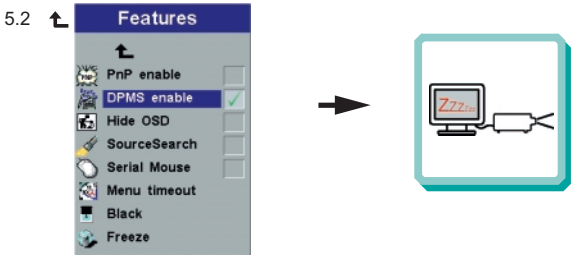

Select DPMS active/inactive. Ref. chapter J  
 DPMS aktivieren/deaktivieren. Siehe Kapitel J  
 Sélection DPMS actif/inactif. Voir chapitre H  
 Selecciona activar/desactivar DPMS. Consultar capítulo J  
 Selezione del DPMS attivo/inattivo. Vedere il capitolo J  
 Selezione DPMS ativo/inativo. Ref. capítulo J  
 Velg om DPMS-funksjonen skal være aktiv/inaktiv. Se kapittel J

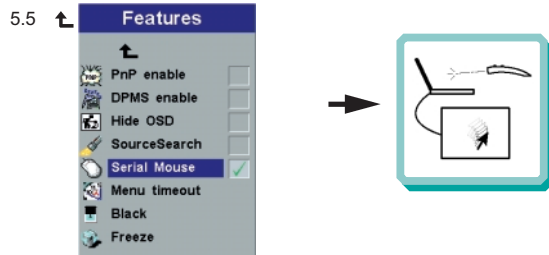

Activate to select mouse; Deactivate to select RS232 control. Ref chapter G  
 Aktivieren für Maussteuerung; deaktivieren für RS232-Steuerung. Siehe Kapitel G  
 Activer pour sélectionner la souris; Désactivez pour sélectionner la commande RS232. Voir chap G  
 Active para seleccionar el ratón; Desactive para seleccionar el control RS232. Ref. Capítulo G  
 Attivare per selezionare il mouse; Disattivare per selezionare il comando RS232. Rif. Cap. G  
 Ative para selecionar o rato; Desative para selecionar o controle RS232. Ref. Capítulo G  
 Aktivier for å velge mus; Deaktivier for å velge RS232 kontrol. Se kapittel G

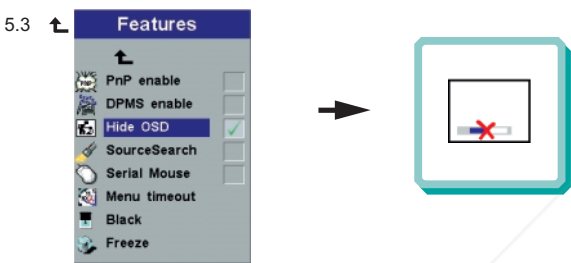

Select to hide On Screen Display (OSD)  
 Markieren, um Bildschirmmenü zu verbergen  
 Sélectionner pour effacer l'affichage sur l'écran  
 Seleccionar para ocultar la presentación en pantalla  
 Selezione per nascondere OSD  
 Selezione para ocultar a exibição na tela (OSD)  
 Velges hvis du vil slå av menyvisningen (OSD)

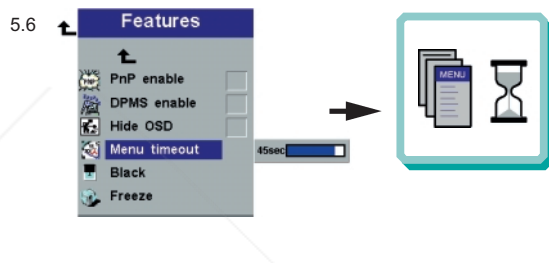

Select time from 5 to 50 sec. before the OSD menu-display hides  
 Zeit von 5 bis 50 s einstellen, bevor Bildschirmmenü verborgen wird  
 Sélection du temps, entre 5 et 50 sec., avant disparition de l'affichage menu OSD  
 Selección entre 5 y 50 seg. antes de ocultar el menú de presentación de OSD  
 Selezione del tempo da 5 secondi a 50 secondi prima che il menù sullo schermo scompaia  
 Selezione un tempo de 5 a 50 seg. para que a exibição na tela (OSD) se oculte  
 Velg tid fra 5 till 50 sek. for menyvisningen (OSD) på skjermen slås av

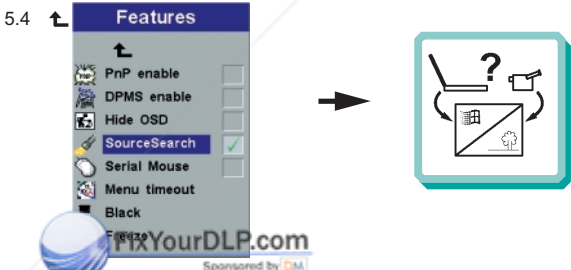

Select to activate/deactivate automatic source search  
 Entsprechend wählen, um automatische Quellensuche zu aktivieren/deaktivieren  
 Sélectionner 'activer/désactiver' la recherche automatique de source  
 Seleccionar para activar/desactivar la búsqueda automática del origen  
 Selezione per attivare/disattivare la ricerca della sorgente automatica  
 Selezione para ativar/desativar a busca automática de fonte  
 Velges om automatisk kildesøkning skal være aktiv/inaktiv

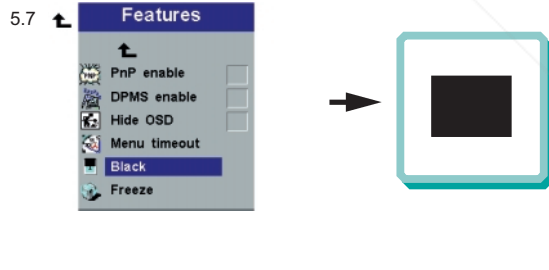

Select for blacking the projected image  
 Wählen, um Bild zu verdunkeln  
 Sélectionner pour assombrir l'image projetée  
 Seleccionar para bajar la imagen proyectada a negro  
 Selezione per oscurare l'immagine proiettata  
 Selezione para pretejar a imagem projetada  
 Velges hvis du vil gjøre bildet som vises sort

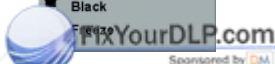

Discount-Merchant.com (800) 281-8860  
 THE #1 SOURCE FOR PROJECTOR LAMPS AND ACCESSORIES

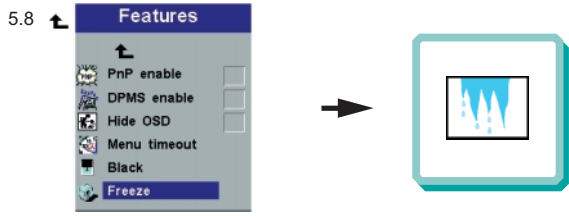

Freezes the projected image  
 Einfrieren des projizierten Bildes  
 Congèle l'image projetée  
 Congela la imagen proyectada  
 Congelamento dell'immagine proiettata  
 Congela a imagem projetada  
 Fryser bildet som vises

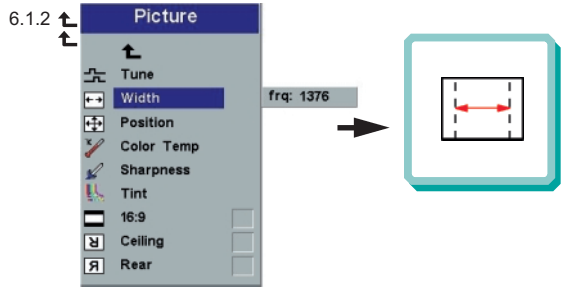

Adjusts width to computer analog image size  
 Anpassung der Breite auf Größe des analogen Computerbildes  
 Règle la largeur à la dimension de l'image analogique de l'ordinateur  
 Ajusta el ancho al tamaño de la imagen del ordenador analógico  
 Regolazione della larghezza alla dimensione dell'immagine analogica del computer  
 Ajusta a largura ao tamanho da imagem analógica de computador  
 Justerer bredden på datamaskinens analoge bilde

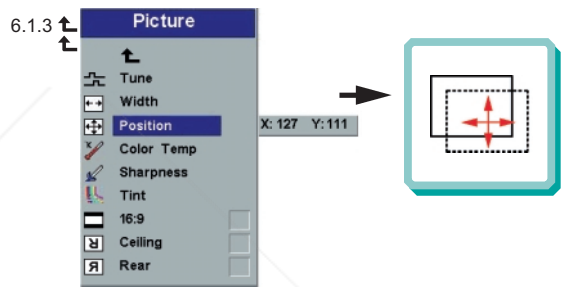
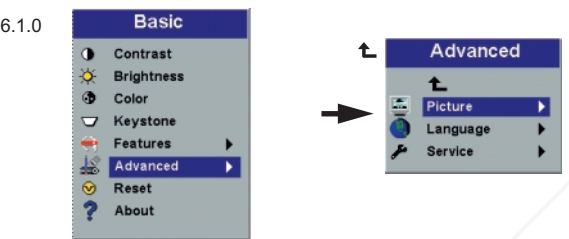

Adjusts position to computer analog and video image size  
 Anpassung der Position auf Größe Analog- und Videobildes  
 Règle la position à la dimension de l'image analogique de l'ordinateur et de la vidéo.  
 Ajusta la posición al tamaño de la imagen del ordenador analógico y del video  
 Regolazione della posizione alle dimensioni dell'immagine analogica e video del computer  
 Ajusta a posição ao tamanho de imagem de computador analógica e de vídeo  
 Justerer plasseringen på datamaskinens analoge bilde og videobilde

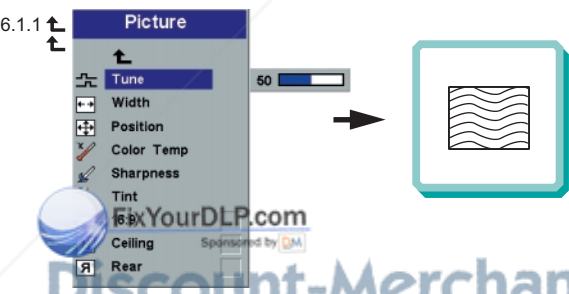

Adjusts horizontal phase/fine tunes computer analog image  
 Einstellung der Horizontalfrequenz/Einstellen für analoge Computerbilder  
 Règle la phase horizontale/met au point l'image analogique de l'ordinateur  
 Ajusta la fase horizontal/sintoniza la imagen del ordenador analógico  
 Regolazione della faseatura orizzontale/sintonizzazione fine dell'immagine analogica del computer  
 Ajusta as sintonias fase/fina horizontais da imagem analógica de computador  
 Justerer den horizontale faser/finstiller datamaskinens analoge bilde

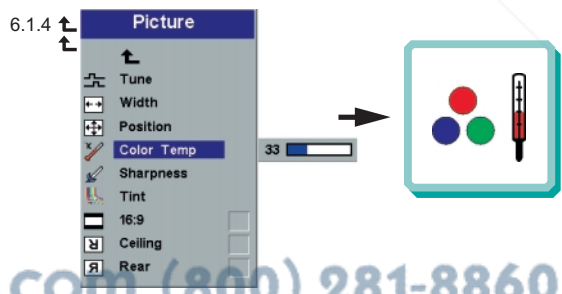

Modifies color temperature balance from 0-100  
 Veränderung des Farbtemperaturwertes von 0-100  
 Modifie l'équilibre de la température couleur de 0 à 100  
 Modifica el equilibrio de temperatura del color entre 0-100  
 Modifica dell'equilibrio della temperatura di colore da 0 a 100  
 Modifica o equilíbrio da temperatura da cor de 0 a 100  
 Endrer balansen for fargetemperatur innenfor området 0-100

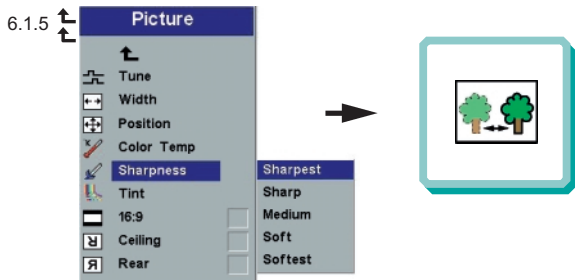

Adjusts sharpness in video images  
 Einstellung der Schärfe von Videobildern  
 Règle la netteté des images vidéo  
 Ajusta la nitidez de la imagen de video  
 Regolazione della nitidezza dell'immagine video  
 Ajusta a nitidez nas imagens de video  
 Justerer skarpheten i videobilder.

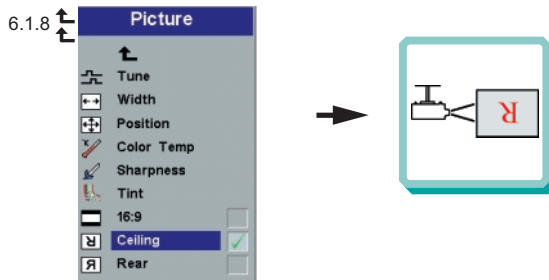

Select for ceiling mounted projection  
 Markieren für Projektion bei Deckenmontage  
 Sélectionner pour la projection appareil au plafond  
 Seleccionar para proyección montada en el techo  
 Selezione per la proiezione con montaggio al soffitto  
 Seleção para projeção com montagem no teto  
 Velges hvis du vil bruke takmontert projeksjon

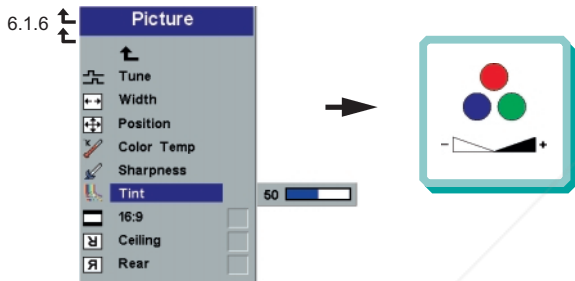

Varies the hue in video NTSC images from 0-100  
 Veränderung der Farbe von NTSC Videobildern von 0-100  
 Modifie le ton des images NTSC vidéo de 0 à 100  
 Varía la tonalidad de la imagen de vídeo NTSC entre 0-100  
 Variazione della tonalità cromaticada 0 a 100 nelle immagini video NTSC  
 Varia a tonalidade em imagens de vídeo NTSC de 0 a 100  
 Endrer fargenyansen til NTSC-videobilder innenfor området 0-100

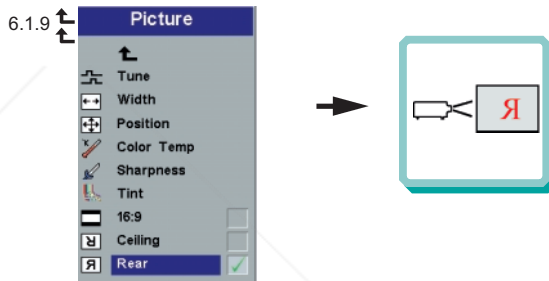

Select for rear projection  
 Markieren für Projektion von hinten  
 Sélectionner pour afficher l'information réparations  
 Seleccionar para proyección de transparencias  
 Selezione per la retroproiezione  
 Seleção para projeção de serviço autorizado  
 Velges hvis du vil bruke bakprojeksjon

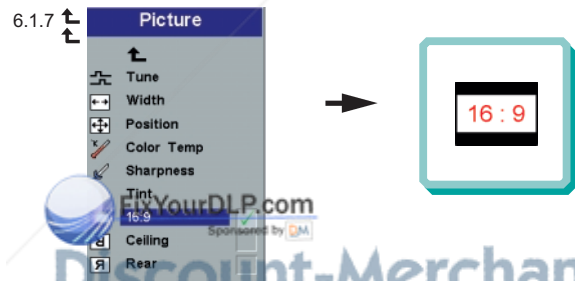

Select 16:9 widescreen image format  
 Auswahl Breitbildformat 16:9  
 Sélectionner pour remettre toutes les options sur paramètres usine  
 Seleccionar el formato de imagen de pantalla ancha 16:9  
 Selezione del formato panoramico 16:9  
 Selecciona o formada de imagem com largura de tela 16:9  
 Velg vidvinkelformatet 16.9 for bildet

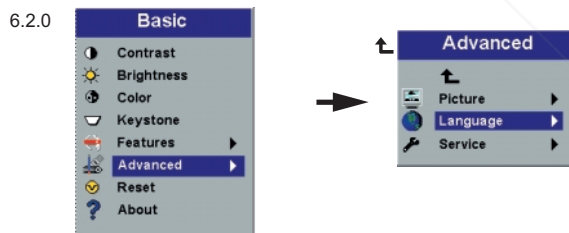

Discount-Merchant.com (800) 281-8860  
 SOURCE FOR PROJECTOR LAMPS AND ACCESSORIES



# MENU ADJUSTMENTS

MENÜEINSTELLUNGEN OPTIONS DE MENU MENÚ DE AJUSTES IMPOSTAZIONI DAL MENU AJUSTES DO MENU MENYINNSTILLINGER

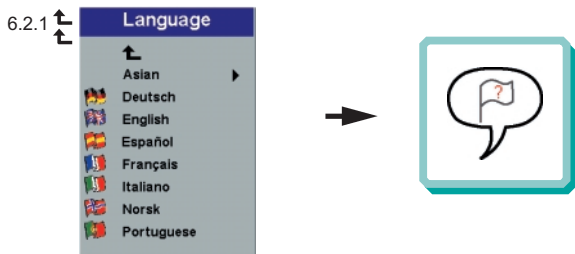

Select language  
 Sprache auswählen  
 Sélectionne la langue  
 Seleccionar lenguaje  
 Selezione della lingua  
 Selecciona o idioma  
 Velg språk

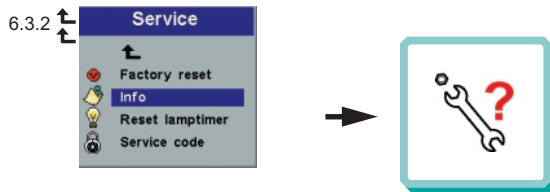

Select to display service information  
 Aktivieren, um Serviceinformationen anzuzeigen  
 Sélectionner pour afficher l'information réparations  
 Sólo para personal técnico  
 Selezione per visualizzare le informazioni sull'assistenza  
 Seleção para obter informação sobre a fonte selecionada  
 Velges hvis du vil vise serviceinformasjon

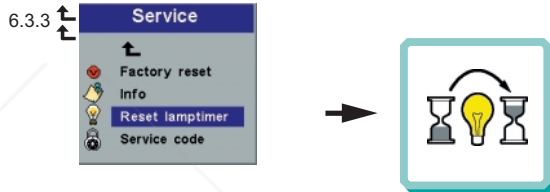
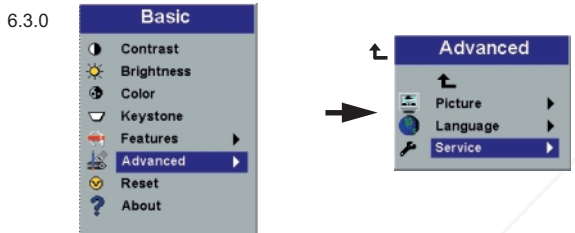

Select to reset lamp timer after lamp replacement  
 Aktivieren, um Lampenstundenzähler nach dem Austausch auf Null zu setzen  
 Sélectionner pour remettre l'horloge de la lampe à zéro après changement de lampe.  
 Seleccionar para restablecer el temporizador de la bombilla tras la sustitución de la misma.  
 Selezione per ripristinare il temporizzatore della lampadina dopo la sua sostituzione.  
 Seleção para zerar o cronômetro da lâmpada após substituição da mesma  
 Velges for å tilbakestille telleverket for lampen etter lampeskift

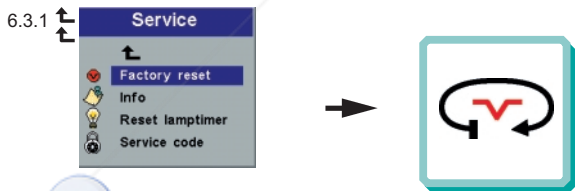

Select to reset all options to factory settings  
 Aktivieren, um alle Optionen auf Werkseinstellung zu setzen  
 Sélectionner pour remettre toutes les options sur paramètres usine  
 Seleccionar para restablecer todas las opciones a la configuración original  
 Selezione per il ripristino di tutte le opzioni sulle impostazioni di fabbrica  
 Seleção para que as opções retornem à programação inicial de fábrica  
 Velges hvis du vil tilbakestille alle innstillinger til fabrikkinnstillingene

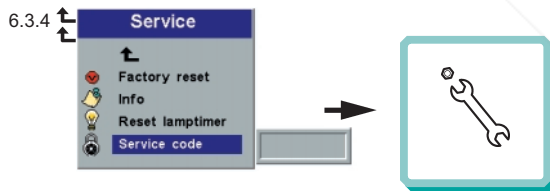

Only for service personnel  
 Nur für Kundendienstpersonal  
 Pour le personnel technique uniquement  
 Sólo para personal técnico  
 Ad uso esclusivo dei tecnici di assistenza  
 Somente para serviço autorizado  
 Bare for servicepersonell



Discount Merchant.com (800) 281-8860  
 PROJECTOR PARTS AND ACCESSORIES

7.0

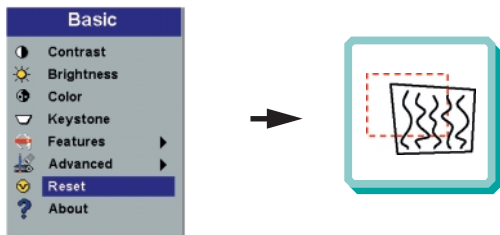

Synchronizes the projector settings to the active source  
 Synchronisiert die Projektoreinstellungen für die aktive Quelle  
 Synchronise les paramètres du projecteur avec la source active  
 Sincroniza las configuraciones del proyector con la fuente activa  
 Sincronizzazione delle impostazioni del proiettore sulla sorgente attiva  
 Sincroniza a configuração do projetor com a fonte ativa  
 Synkroniserer projektorens innstillinger med den aktive kilden

8.0

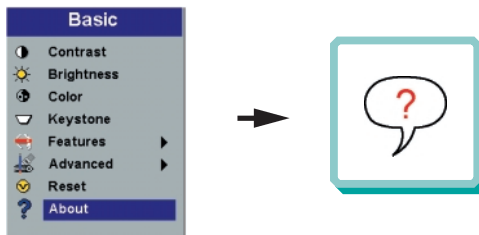

Indicates information about selected source  
 Zeigt Information über die aktive Quelle an  
 Renseigne sur la source sélectionnée  
 Proporciona información sobre fuentes seleccionadas  
 Informazioni sulla sorgente selezionata  
 Fornece informação sobre a fonte selecionada  
 Viser informasjon om den valgte kilden

## G

### CONTROL RS 232

STEUERN SIE RS 232 CONTRÔLE LES RS 232 CONTROLE RS 232 GESTIRE RS 232 CONTROLE RS 232 KONTROLLERE RS232



To enable the serial RS232 control please do the following:  
 Um die serielle Schnittstelle RS232 zu aktivieren, ist folgendes zu tun:  
 Pour activer la commande série RS232, procédez comme suit.  
 Para activar el control de serie RS232, proceda del siguiente modo:  
 Per attivare il comando RS232 seriale effettuare le seguenti operazioni:  
 Para habilitar o controle serial RS232 efetue as seguintes operações:  
 Slik aktiverer du den serielle RS232-kontrollen

- Remove the checkmark from "Serial Mouse" in the projectors Feature Menu  
 Entfernen Sie das Häkchen aus dem Kästchen "Serielle Maus" im Menü Eigenschaften des Projektors  
 Retirez la marque de vérification de "Serial Mouse" en el Menu de Opciones del proyector  
 Deselezionez a casella "Mouse Seriale" nel Menu Caratteristica del proiettore  
 Remova a marca de verificação de "Rato Serial" no "Feature Menu" dos projetores  
 Fjern avmerkingen for "Seriell Mus" på projektorens Egenskaper-meny
- Connect the serial (COM) port from the Host (Computer) to the Mouse 1 connector on the projector  
 Schließen Sie die serielle Schnittstelle (COM) des Computers an den Mouse 1 Anschluss des Projektors  
 Connectez le port en série (COM) de l'Hôte (Ordinateur) au connecteur de Mouse 1 (Souris 1) sur le projecteur  
 Conecte el puerto de serie (COM) de Host (ordenador) al conector Mouse 1 del proyector  
 Collegare la porta seriale (COM) dall'Host (Computer) al connettore del Mouse 1 sul proiettore  
 Conecte a porta serial (COM) do Host (Computador) ao conector 1 do Mouse no projetor  
 Koble den serielle porten (COM-porten) på verten (datamaskinen) til kontakten merket Mouse 1 på projektoren
- To make the connection use: (F) Mouse Cable (supplied) with (X) PC Mouse Adapter RS232 Straight (optional)  
 Zur Herstellung der Verbindung: (F) Maus kabel (mitgeliefert) mit (X) PC Maus-Adapter RS232 gerade (optional)  
 Pour réaliser la connexion, utilisez: le câble de la souris (F) (fourni avec l'appareil) avec l'adaptateur RS232 de souris PC (X) (en option)  
 Para realizar la conexión, utilice: (F) Cable del Ratón (suministrado) con (X) Adaptador de Ratón para PC RS232 Directo (opcional)  
 Per effettuare il collegamento utilizzare: (F) Cavo del Mouse (fornito) con (X) Adattatore Mouse per PC RS232 Diretto (facoltativo)  
 Para efetuar a conexão use: (F) Cabo do Rato (fornecido) com o Adaptador do Rato PC (X) RS232 Reto (opcional)  
 Tilkoblingen foretas ved hjelp av (F) musekabelen (vedlagt) eller (X) en adapter for PC-mus RS232 rett (tilleggsutstyr)

1

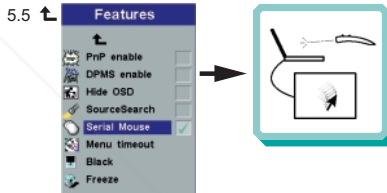

2

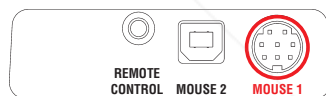

3

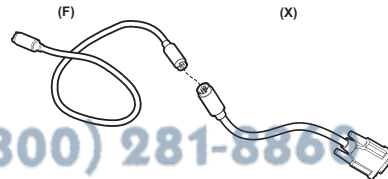

FixYourDLP.com

default RS232 control settings are:  
 Die Standardeinstellungen für RS232 sind:  
 Les paramètres de commande par défaut du RS232 sont:  
 La configuración de control predeterminada para RS232 es:  
 Le impostazioni predefinite del comando RS232 sono:  
 As definições por defeito do controle RS232 são:  
 Standardinnstillingene for RS232 kontroll er:

- Baudrate 9600  
Data bit 8
- Parity bit None  
Stop bit 1
- Flow Control None

Source for Projector Lamps and Accessories

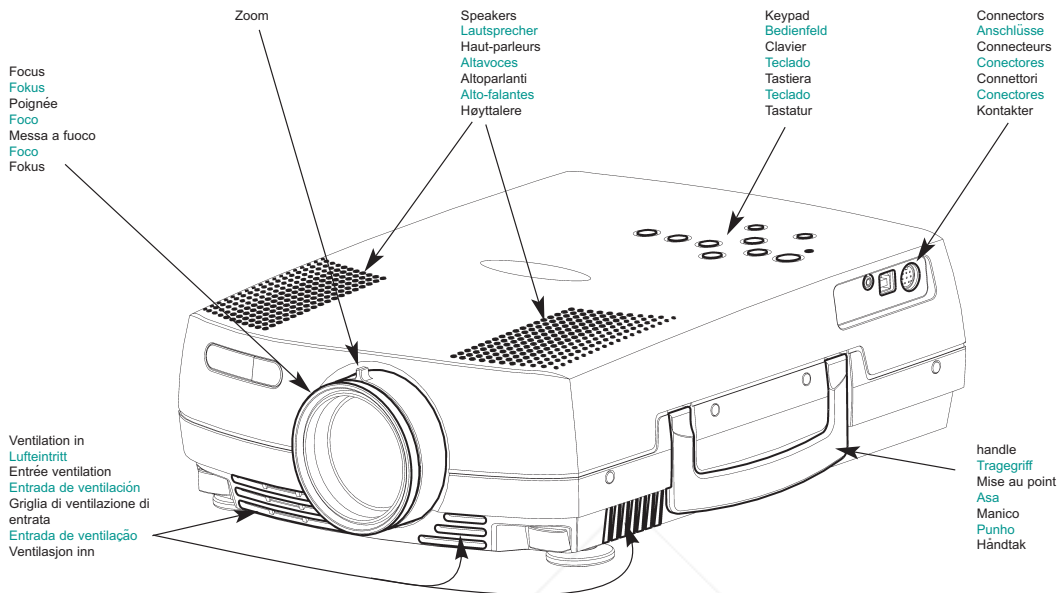

Ceiling mount (use 1/4" screw). Min. distance from ceiling/rear wall: 30/50 cm, 12/20 inch for proper ventilation.

Deckenmontage (1/4"-Schrauben verwenden). Mindestabstand von der Decke/Rückwand 30/50 cm, damit eine korrekte Belüftung gewährleistet ist  
 Montage au plafond (utilisez un tournevis 1/4"). Distance minimum au plafond/mur arrière: 30/50 cm, pour garantir une ventilation adéquate  
 Soporte de techo (utilice un tornillo de 1/4"). Distancia mínima desde el techo/pared posterior: 30/50 cm, para que exista una ventilación correcta  
 Montaggio a soffitto (utilizzare viti da 1/4"). Distanza minima dal soffitto/muro posteriore 30/50 cm, per una ventilazione adeguata  
 Montagem no teto (use parafuso de 1/4"). Distância min. do teto/pared traseira: 30/50 cm, para uma ventilação adequada  
 Takbeslag (bruk 1/4" skruer). Min. distanse fra tak/bakvegg: 30/50 cm, for å få tilstrekkelig ventilasjon

Adjustable foot  
Höhenverstellbarer Fuß  
Pieds réglables  
Pata ajustable  
Piede regolabile  
Pé ajustável  
Justerbar fot

Adjustable foot  
Höhenverstellbarer Fuß  
Pieds réglables  
Pata ajustable  
Piede regolabile  
Pé ajustável  
Justerbar fot

Dust filter  
Staubfilter  
Filtre de la poussière  
Filtro del polvo  
Filtro della polvere  
Filtro da poeira  
Støv filter

Lamp housing  
Lampenfach  
Support de lampe  
Lugar para la lámpara  
Scomparto lampadina  
Compartimento da lâmpada  
Lampehus

Ventilation out  
Luftaustritt  
Sortie ventilation  
Salida de ventilación  
Griglia di ventilazione di uscita  
Saída de ventilação  
Ventilasjon ut



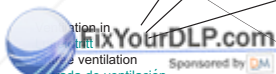

Power  
Netzanschluss  
Alimentation  
Alimentación  
Alimentazione elettrica  
Alimentação elétrica  
Strøm



Connectors  
Anschlüsse  
Connecteurs  
Conectores  
Connettori  
Conectores  
Kontaktør



Count-Merchant.com (800) 281-1100

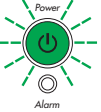

THE TRUSTED SOURCE FOR PROJECTOR LAMPS AND ACCESSORIES

CONDITION LEUCHTANZEIGE ETAT INDICACIÓN CONDIZIONE CONDICÃO TILSTAND	STATUS ZUSTAND STATUT ESTADO STATO STATUS STATUS	EXPLANATION ERLÄUTERUNG EXPLICATION EXPLICACIÓN SPIEGAZIONE EXPLICACÃO FORKLARING
Green Grün Vert Luz verde Verde Verde Grønt   Alarm	Power ON (picture on the screen) EIN (Bild auf Leinwand) Position ON (image sur l'écran) Encendido (ON) (imagen en pantalla) Acceso (immagine sullo schermo) Ligado (imagem na tela) Strøm PÅ (bilde på skjermen)	Normal mode. Betriebsmodus Mode normal Modo normal Modalità normale Modo normal Normal modus.
Slow orange blinking. Orange (langsam blinkend). Orange pâle clignotant. Luz naranja parpadeando lentamente. Lampeggio arancione lento Laranja piscando lentamente Oranje, langsomt blinkende.   Alarm	Power OFF has been selected and OSD logo screen is displayed. Der Projektor wurde auf AUS gestellt, das OSD-Logo wird angezeigt. La position OFF a été sélectionnée et l'écran logo OSD est affiché Se ha seleccionado APAGADO y la (OFF) pantalla muestra el logotipo de OSD. É stato selezionato lo spegnimento OFF e viene proiettato sullo schermo il logo OSD A opção DESLIGAR foi selecionada e a tela do logotipo OSD é exibida. Strøm AV er valgt, og logoskjermbildet for OSD vises.	The projector is going to standby. Projektor geht in Standby-Modus über Le projecteur passe en standby (attente) El proyector se coloca en stndby Il proiettore sta entrando in stand-by O projetar está entrando em standby Projektoren går til ventemodus
Orange Orange Orange Luz naranja Arancione Laranja Oransje   Alarm	Standby mode Standby-Modus Mode standby (attente) Modo standby Modalità stand-by Modo standby Ventemodus	The projector is in standby (sleep) mode. Der Projektor befindet sich in Standby-Modus Le projecteur est en mode standby (attente) El proyector está en modo standby (sleep) Il proiettore è in modalità stand-by (sleep) O projetor está em modo standby (descanso) Projektoren er i ventemodus (dvalermodus)
Red Rot Rouge Luz roja Rosso Vermelho Rødt   Alarm	Lamp life has expired, OSD message is displayed. Lampenwechsel ist fällig, OSD-Meldung erscheint. La durée de vie de la lampe est dépassée, un message OSD est affiché. Aparece un mensaje de OSD indicando que la bombilla se ha agotado. La vita utile della lampadina è giunta a termine, viene proiettato il messaggio OSD A vida útil da lâmpada expirou, uma mensagem OSD é exibida. Lampens levetid er overskredet, OSD-melding vises.	The lamp lifetime is overdue. Return the projector to qualified service personnel for lamp change. Die Lebensdauer der Lampe ist abgelaufen. Lassen Sie einen Lampenwechsel vonqualifiziertem Kundendienstpersonal durchführen. La durée de vie de la lampe est dépassée. Retournez le projecteur au personnel technique qualifié pour le changement de lampe. La vida útil de la bombilla se ha agotado. Lieve el proyector a un servicio técnico autorizado para cambiarla. È stata superata la durata della lampadina. Rendere il proiettore a tecnici di assistenza qualificati per la sostituzione della lampadina. A vida útil da lâmpada está ultrapassada. Leve o projetor a um serviço de assistência qualificado para troca de lâmpada. Lampens levetid er overskredet. Send projektoren til kvalifisert servicepersonell for lampeskift.

<b>CONDITION</b> <b>LEUCHTANZEIGE</b> <b>ETAT</b> <b>INDICACIÓN</b> <b>CONDIZIONE</b> <b>CONDICÃO</b> <b>TILSTAND</b>	<b>STATUS</b> <b>ZUSTAND</b> <b>STATUT</b> <b>ESTADO</b> <b>STATO</b> <b>STATUS</b> <b>STATUS</b>	<b>EXPLANATION</b> <b>ERLÄUTERUNG</b> <b>EXPLICATION</b> <b>EXPLICACIÓN</b> <b>SPIEGAZIONE</b> <b>EXPLICAÇÃO</b> <b>FORKLARING</b>
<p>Fast green blinking                      Grün (schnell blinkend)                      Vert à clignotement rapide                      Luz verde parpadeando rápidamente                      Lampeggio verde rapido                      Verde piscando rapidamente                      Grønt, raskt blinkende</p> 	<p>Lamp ignition failed (lamp is too hot)                      Lampe wird nicht gezündet (die Lampe ist zu warm)                      Lampe reste éteinte (surchauffe de la lampe)                      Lámpara sigue apagada (sobrecalentamiento de la lámpara)                      Lâmpada spenta (é surriscaldada)                      Lâmpada fica apagada (sobre-aquecimento)                      Tenning av lampen feilet (lampen er for varm)</p>	<p>The projector will cool down the lamp before turning on the lamp again                      Der Projektor kühlt ab bevor die Lampe wieder gezündet wird                      Le projecteur refroidit la lampe avant de la rallumer                      El projector refrigera la lámpara antes de apagarla                      Il proiettore ventila la lampada prima di accenderla di nuovo                      O projector arrefece a lâmpada antes de a voltar a ligar                      Prosjektoren vil kjøle ned lampen, før lampen tennes på nytt</p>
<p>Fast red blinking                      Rot (schnell blinkend)                      Rouge à clignotement rapide                      Luz roja parpadeando rápidamente                      Lampeggio rosso rapido                      Vermelho piscando rapidamente                      Rødt, raskt blinkende</p> 	<p>High temperature, OSD message is displayed.                      Überhitzung, OSD-Meldung wird angezeigt.                      Température élevée, Un message OSD est affiché                      Aparece un mensaje de OSD que indica temperatura elevada.                      Temperatura elevata, viene proiettato il messaggio OSD.                      Temperatura alta. Uma mensagem OSD é exibida.                      OSD-melding om høy temperatur vises.</p>	<p>The projector temperature is above the critical limit. Please allow the projector to cool down by turning off the projector.                      Die Temperatur des Projektors befindet sich im kritischen Bereich. Schalten Sie den Projektor aus und lassen ihn abkühlen.                      La température du projecteur est trop élevée. Eteignez le projecteur et laissez-le refroidir.                      La temperatura del proyector ha alcanzado el punto crítico. Apague el proyector y deje que se enfríe.                      La temperatura del proiettore ha superato il limite critico. Spegnere il proiettore e lasciarlo raffreddare                      A temperatura do projetor está acima do limite crítico. Por favor permita que o projetor esfrie desligando-o.                      Projektorens temperatur er over den kritiske grensen. slå projektoren av slik at den kan kjøle seg ned.</p>



**Discount-Merchant.com (800) 281-8860**  
**THE TRUSTED SOURCE FOR PROJECTOR LAMPS AND ACCESSORIES**

<b>CONDITION</b> <b>LEUCHTANZEIGE</b> <b>ETAT</b> <b>INDICACIÓN</b> <b>CONDIZIONE</b> <b>CONDICÃO</b> <b>TILSTAND</b>	<b>STATUS</b> <b>ZUSTAND</b> <b>STATUT</b> <b>ESTADO</b> <b>STATO</b> <b>STATUS</b> <b>STATUS</b>	<b>EXPLANATION</b> <b>ERLÄUTERUNG</b> <b>EXPLICATION</b> <b>EXPLICACIÓN</b> <b>SPIEGAZIONE</b> <b>EXPLICACÃO</b> <b>FORKLARING</b>
<p>Slow green blinking Grün (langsam blinkend) Vert à clignotement lent Luz verde parpadeando lentamente Lampeggio verde lento Verde piscando lentamente Grønt, langsomt blinkende</p> 	<p>DPMS Mode (black screen) DPMS-Modus (schwarze Leinwand) Mode DPMS (écran noir) Modo DPMS (pantalla en negro) Modalità DPMS (schermo nero) Modo DPMS (Tela preta) DPMS-modus (svart skjerm)</p>	<p>No valid source detected Keine zulässige Quelle gefunden Aucune source adéquate détectée No se ha detectado ninguna fuente válida Non viene rilevata nessuna sorgente Nenhuma fonte válida foi detectada Ingen gyldig kilde funnet</p>
<p>Slow green blinking Grün (langsam blinkend) Vert à clignotement lent Luz verde parpadeando lentamente Lampeggio verde lento Verde piscando lentamente Grønt, langsomt blinkende</p> 	<p>OSD logo screen is displayed OSD-Logo wird angezeigt L'écran logo OSD est affiché La pantalla muestra el logotipo de OSD Viene proiettato il logo OSD A tela do logotipo OSD é exibida Logoskjermbildet for OSD vises</p>	<p>The projector will search until a valid source is detected Der projektor versucht eine zulässige Quelle zu finden Le projecteur cherchera jusqu'à détecter une source adéquate El proyector buscará hasta detectar una fuente válida Le projecteur cherchera jusqu'à trouver une source valide O projetor procurará até detectar uma fonte válida Projektoren vil søke til en gyldig kilde blir funnet</p>
<p>Slow green blinking Grün (langsam blinkend) Vert à clignotement lent Luz verde parpadeando lentamente Lampeggio verde lento Verde piscando lentamente Grønt, langsomt blinkende</p> 	<p>DPMS Mode (Lamp is off) DPMS-Modus (Lampe ist aus) Mode DPMS (La lampe est éteinte) Modo DPMS (la bombilla está apagada) Modalità DPMS (la lampadina è spenta) Modo DPMS (a lâmpada está desligada) DPMS-modus (lampen er av)</p>	<p>No valid source detected in the last 3 minutes. The projector will stay in this mode for 5 minutes. If you get a valid source within 5 minutes, the projector will turn on again. Nach Ablauf von 3 Minuten keine zulässige Quelle gefunden. Der Projektor bleibt 5 Minuten lang in diesem Zustand. Wenn Sie in dieser Zeit eine zulässige Quelle anschließen, schaltet sich der Projektor wieder ein. Aucune source adéquate détectée au cours des 3 dernières minutes. La projecteur restera sur ce mode pensant 5 minutes. Si vous lui fournissez une source adéquate dans les 5 minutes, il s'allumera de nouveau. Han transcurrido 3 minutos sin detectar ninguna fuente válida. El proyector permanecerá en este modo durante 5 minutos. Si dentro de ese plazo se le proporciona una fuente válida, volverá a ponerse en marcha. Non è stata rilevata nessuna sorgente valida negli ultimi tre minuti. Il proiettore rimarrà in questa modalità per 5 minuti. Se si trova una sorgente valida entro 5 minuti, il proiettore tornerà ad accendersi. Nenhuma fonte válida foi detectada nos últimos 3 minutos. O projetor permanecerá neste modo por 5 minutos. O projetor ligará novamente se obtiver uma fonte válida dentro de 5 minutos. Ingen gyldig kilde funnet i løpet av de siste 3 minuttene. Projektoren holder seg i denne modusen i 5 minutter. Hvis det blir funnet en gyldig kilde i løpet av 5 minutter, slår projektoren seg på igjen.</p>



**No image on the screen**  
**Kein Bild auf der Leinwand**  
**Pas d'image sur l'écran**  
**Sin imagen en pantalla**  
**Assenza di immagine sullo schermo**  
**Não há imagem na tela**  
**Skjermen viser ikke bilde**

1. Verify the power connections to the projector (check that the power light is on)  
**Stromanschluss des Projektors überprüfen (Power-Leuchtanzeige muss leuchten)**  
 Vérifiez les connexions de l'alimentation au projecteur (vérifiez que l'indicateur d'alimentation est allumé)  
 Verifique las conexiones del proyector (compruebe que la luz de energía está encendida)  
 Verificare la connessione dell'alimentazione del proiettore (controllare che la spia dell'alimentazione sia accesa)  
 Verifique as conexões de alimentação elétrica do projetor (veja se a luz que indica o estado de ligado está acesa)  
 Kontroller strømtilkoblingen for projektoren (sjekk at lyset for strøm er på)
2. Verify the settings on your laptop  
**Einstellungen am Laptop überprüfen**  
 Vérifiez les paramètres sur votre portable  
 Verifique las configuraciones de su ordenador  
 Verificare le impostazioni del computer  
 Verifique as configurações no seu laptop  
 Kontroller innstillingene på den bærbare datamaskinen
3. Verify that the black-button is not activated on the remote  
**Prüfen, dass "Black" (Verdunkeln) an der Fernbedienung nicht aktiviert ist**  
 Vérifiez que le bouton noir n'est pas activé sur la télécommande  
 Verifique que el botón negro no esté activado para control remoto  
 Verificare che il pulsante nero sul telecomando non sia attivato  
 Assegure-se de que botão preto não esteja ativado no controle remoto  
 Kontroller at Black-knappen på fjernkontrollen ikke er aktivert
4. Check if lens cap is mounted  
**Sicherstellen, dass die Linsenabdeckung abgenommen ist**  
 Assurez-vous que la protection de la lentille n'est pas posée  
 Compruebe que la tapa de la lente está montada  
 Controllare che non sia montato il coperchio della lente  
 Verifique se o protetor de lente está colocado  
 Kontroller om linsedekselet er på



**The projected image is not focused**  
**Das projizierte Bild ist nicht scharf**  
**L'image projetée n'est pas au point**  
**La imagen proyectada no está enfocada**  
**L'immagine proiettata non è a fuoco**  
**A imagem projetada está fora de foco**  
**Bildet som projiseres er ikke i fokus**

2. Adjust the focus ring on the projection lens  
**Fokusing an der Linse einstellen**  
 Réglez la bague de mise au point sur la lentille de projection  
 Ajuste el aro de enfoque de la lente de proyección  
 Regolare l'anello di messa a fuoco sulla lente di proiezione  
 Ajuste o anel de foco à lente de projeção  
 Vri på fokuseringsringen på projeksjonslinsen
3. Ensure that the projection lens is clean  
**Prüfen, ob Linse sauber ist**  
 Vérifiez que la lentille de projection est propre  
 Asegúrese de que la lente de proyección está limpia  
 Assicurarsi che la lente di proiezione sia pulita  
 Assegure-se de que a lente de projeção está limpa  
 Kontroller at projeksjonslinsen er ren
4. In Video: Check the sharpness setting in the advanced/picture menu and adjust if necessary  
**Bei Video: Schärfereinstellung im Menü Optionen/Bild prüfen und bei Bedarf ändern**  
 Source Vidéo: Vérifiez le réglage de netteté de l'image dans le menu "advanced/picture" et réglez si besoin est  
 En vídeo: compruebe la configuración de la nitidez en el menú avanzado/de imagen y ajústelo si fuera necesario  
 In Video: Controllare la regolazione della nitidezza nel menu Advanced / Picture e regolarla se necessario  
 No vídeo: verifique a configuração da nitidez no menu avançado/imagem e ajuste-a se necessário  
 I video-modus: Kontroller innstillingen for skarphet på menyen Advanced/picture, og tilpass den om nødvendig
5. Verify that the projector is correctly aligned with the projected screen  
**Prüfen, ob der Projektor richtig zur Leinwand ausgerichtet ist**  
 Vérifiez que le projecteur est correctement aligné avec l'écran  
 Verifique que el proyector está correctamente alineado con la pantalla proyectada  
 Verificare che il proiettore sia allineato correttamente con lo schermo  
 Verifique se o projetor está corretamente alinhado com a tela de projeção  
 Kontroller at projektoren er korrekt plassert i forhold til skjermen det projiseres



**No sound**  
**Kein Ton**  
**Pas de son**  
**Sin sonido**  
**Nessun suono**  
**Não há som**  
**Ingen lyd**

1. Check the audio input connections  
**Verbindung am Audioeingang überprüfen**  
 Vérifiez les connexions entrée audio  
 Compruebe las conexiones de entrada de audio  
 Controllare i collegamenti di ingresso audio  
 Verifique as conexões de entrada de áudio  
 Kontroller tilkoblingene for lydinngangen
2. Adjust the volume  
**Lautstärke einstellen**  
 Réglez le volume  
 Ajuste el volumen  
 Regolare il volume  
 Ajuste o volume  
 Juster lydstyrken
3. Verify that the audio cables OK  
**Prüfen, ob Audiokabel in Ordnung ist**  
 Vérifiez que le câble audio n'est pas endommagé  
 Verifique que el cable de audio está bien  
 Verificare che il cavo audio sia a posto  
 Verifique se o cabo de áudio está conforme  
 Kontroller at lydkaabelen er OK
4. Adjust the audio source  
**Einstellungen an der Audioquelle vornehmen**  
 Réglez la source audio  
 Ajuste la fuente de audio  
 Regolare la sorgente audio  
 Ajuste a fonte de áudio  
 Juster lydkielen

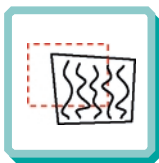

**The projected image is distorted**  
**Das projizierte Bild ist verzerrt**  
**L'image projetée est déformée**  
**La imagen proyectada está distorsionada**  
**L'immagine proiettata è distorta**  
**A imagem projetada está distorcida**  
**Bildet som vises er forvrengt**

1. Press the Power button and go to Reset  
**Auf Power drücken und Reset durchführen**  
 Appuyez sur le bouton "Power" et Remettez à zéro  
**Pulse el botón Power y vaya a Reset (restablecer)**  
 Premere il tasto Power e iniziare il Ripristino (reset)  
**Desligue e ligue novamente o projetor pressionando o botão LIG/DES LIG**  
 Trykk på Power-knappen og gå til Reset

2. Select Menu on remote or on projector  
**Menü über Fernbedienung oder Bedienfeld wählen**  
 Sélectionnez Menu sur la télécommande ou sur le projecteur  
**Seleccione el Menú por control remoto o en el proyector**  
 Selezionare Menù sul telecomando o sul proiettore  
**Selecione o Menu no controle remoto ou no projetor**  
 Trykk på Menu på fjernkontrollen eller projektoren



- 2.1 Go to Advanced  
**Zu Optionen gehen**  
 Choisissez Advanced  
**Vaya a Advanced**  
 Portarsi su Advanced  
**Vá ao menu Avançado**  
 Gå til Advanced



- 2.2 Select Picture  
**Bild wählen**  
 Sélectionnez Picture  
**Selecione Picture**  
 Selezionare Picture  
**Selecione Imagem**  
 Velg Picture



- 2.3 Select Frequency or Tuning for image manual adjustments  
**Frequenz oder Tuning für manuelle Bildeinstellung wählen**  
 Sélectionnez Frequency ou Tuning pour le réglage manuel de l'image  
**Selecione Frequency o Tuning para ajustar manualmente la imagen**  
 Selezionare Frequency o Tuning per la regolazione manuale dell'immagine  
**Selecione Frequência ou Sintonia para ajustes manuais da imagem**  
 Velg Frequency eller Tuning for å justere bildet manuelt

3. Verify that the projector is not tilted/elevated and that it is parallel with the projected screen  
**Sicherstellen, dass der Projektor nicht schief oder zu hoch steht und dass er parallel zur Leinwand ausgerichtet ist**  
 Vérifiez que le projecteur n'est pas incliné/surélévée et qu'il est parallèle à l'écran de projection  
**Verifique que el proyector no está inclinado/elevado y que está en paralelo con la imagen proyectada**  
 Verificare che il proiettore non sia inclinato/elevato e che sia parallelo allo schermo di proiezione  
**Verifique se o projetor não está inclinado/elevado e se está paralelo à tela projetada**  
 Kontroller at projektoren ikke er vippt opp- eller nedover eller hevet, og at den er parallell med skjermen det projiseres

4. Check if the digital keystone function is active. Adjust if necessary  
**Prüfen, ob Trapezverzerrung aktiv ist. Falls nötig, einstellen**  
 Regardez si la fonction keystone digitale est active. Réglez si besoin est  
**Compruebe si la función de distorsión digital está activada. Ajustela si fuera necesario**  
 Controllare che sia attiva la funzione di distorsione digitale. Regolarla se necessario  
**Veja se a função digital do ângulo trapezoidal está ativa. Ajuste se necessário**  
 Kontroller om den digitale keystone-funksjonen er aktiv. Juster den om nødvendig



**Remote does not respond**  
**Fernbedienung funktioniert nicht**  
**La télécommande ne marche pas**  
**El control remoto no responde**  
**Il telecomando non risponde**  
**O controle remoto não funciona**  
**Fjernkontrollen virker ikke**

1. Verify that working batteries are inserted in the remote and that it has been switched on  
**Prüfen, ob Batterien fehlen bzw. leer sind und ob Fernbedienung ei geschaltet ist**  
 Vérifiez que les piles sont en place et qu'elle est allumée Verifique el control remoto tiene pilas y que está encendido  
**Verifique que el control remoto tiene pilas y que está encendido**  
 Verificare che nel telecomando siano inserite batterie funzionanti e che il telecomando sia acceso  
**Verifique se as baterias estão boas, se estão corretamente inseridas no controle remoto e se este está ligado**  
 Kontroller om det er satt inn batterier som virker i fjernkontrollen, og at den er slått på

2. Check for other interfering IR sources in the room i.e. fluorescent light tubes, sunlight, active IR COM ports from laptops etc.  
**andere störende Infrarotquellen im Raum suchen, z.B. Leuchtstoffröhren, Sonnenlicht, aktive Infrarot-Anschlüsse von Laptops, etc.**  
**autres sources interférentes IR pouvant interférer: tubes néons, lumière du soleil, ports COM IR actifs de portables, etc.**  
**pruebe otras posibles fuentes de interferencias de infrarrojos en la habitación, p.e. tubos fluorescentes, luz solar, puerto COM infrarrojo del ordenador activo, etc.**  
 Controllare che nella stanza non vi siano altre sorgenti IR che possano interferire quali tubi luminosi fluorescenti, luce solare, PC portatili con porte COM attive ad IR, ecc.  
**Veja se há outras fontes de irradiação eletromagnética interferindo no local, ou seja, tubos de luz fluorescente, luz do sol, portos de comunicação a infravermelho de laptops etc.**  
 Kontroller om det finnes andre forstyrrende infrarøde kilder i rommet, f.eks. lysstoffrør, sollys, aktive IR COM-porter på bærbare datamaskiner osv.





GENERAL CONDITIONS	ALLGEMEINE DATEN	ENVIRONNEMENT	CONDICIONES GENERALES	CONDIZIONI GENERALI	CONDÇÕES GERAIS	GENERELLE KRAV	
Storage temperature, sealevel	Lagertemperatur, Meeresspiegel	Température de stockage au niveau de la mer	Temperatura de almacenamiento a nivel del mar	Temperatura di conservazione, a livello del mare	Temperatura de armazenamento, a nível do mar	Temperatur ved lagring, havflaten	-40 - 60 °C -40 - 140 F
Storage humidity, non-condensing	Lagerfeuchtigkeit, nicht kondensierend	Humidité de stockage, sanscondensation	Humedad relativa de almacenamiento sin condensación	Umidità di conservazione, senza condensa	Umidade de armazenamento, sem condensação	Fuktighet ved lagring, ikke-kondenserende	10 - 90 % RH
Operating temperature ambient	Raumtemperatur für Betrieb	Température ambiante de fonctionnement	Temperatura ambiente de funcionamiento	Temperatura di funzionamento ambiente	Temperatura de funcionamento	Romtemperatur ved bruk	5 - 35 °C 0-1600 m 5 - 30 °C 1600-3200 m 41 - 95 F 0-5000 ft. 41 - 86 F 5000-10000 ft.
Operating humidity	Betriebsfeuchtigkeit	Humidité de fonctionnement	Humedad relativa de funcionamiento	Umidità di funzionamento	Umidade de funcionamento	Fuktighet ved bruk	20 - 80 % RH Allow for slow acclimatization at high humidity

PROJECTOR UNIT	PROJEKTOR	PROJECTEUR	PROYECTOR	UNITÀ DEL PROIETTORE	PROJETOR	PROJEKTOR-ENHETEN	
Dimensions (HxWxL)	Maße (HxBxL)	Encombrement (HxPxL)	Dimensiones (Alto x Ancho x Largo)	Dimensioni (Alt. x Largh. x Lunghe.)	Dimensões (Alt. x Larg. x Comp.)	Størrelse (HxBxL)	98x250x340 mm 3.9x9.9x13.4 inch
Weight	Gewicht	Poids	Peso	Peso	Peso	Vekt	3.4 kg/7.4 lbs
Projection lens	Linse	Objectif	Lente de proyección	Lente di proiezione	Lente de projeção	Projeksjonslinse	1.3 zoom ratio f=36 - 47 mm F=1.8 - 2.1
Projection distance	Projektionsabstand	Distance de projection	Distancia de proyección	Distanza di proiezione	Distância de projeção	Projeksjonsavstand	1.1 -10m 3.1 - 32.5 ft.
Keystone correction	Trapezentrerrung	Compensation de distorsion trapézoïdale	Corrección de la clave	Correzione della deformazione	Correção da distorção trapezoidal	Keystone-korreksjon	10 degrees
Projection lamp	Projektionslampe	Lampe de projection	Lámpara para proyección	Lampadina di proiezione	Lâmpada de projeção	Projeksjonslampe	150 W UHP
Display	Anzeige	Affichage	Presentación en pantalla	Display	Tela de exibição	Bildeprocessor	3 x LCD 0.9" Polysilikon
Colors	Farben	Couleurs	Colores	Colori	Cores	Farger	16.7 MILLION
Contrast	Kontrast	Contraste	Contraste	Contrasto	Contraste	Kontrast	450 : 1
Pixels	Auflösung	Résolution	Pixels	Pixel	Resolução	Piksler	XGA: 1024x768

Subject to change    Änderungen vorbehalten    Sous réserve de modifications    Sujetos a posibles cambios    Soggetti a modifica    Sujeito a modificações    Kan endres



**Discount-Merchant.com (800) 281-8860**  
**THE TRUSTED SOURCE FOR PROJECTOR LAMPS AND ACCESSORIES**

PROJECTOR UNIT	PROJEKTOR/ GERÄT	PROJETEUR	PROYECTOR	UNITÀ DEL PROIETTORE	PROJETOR	PROJEKTOR- ENHETEN	
Video frequency	Videofrequenz	Entrée ordinateur	Frecuencia de video	Frequenza video	Frequência de vídeo	Videofrekvens	12-150 MHz
Horizontal sync.	Horizontalfrequenz	Sync. horizontale	Sinc. horizontal	Sinc. orizz	HorizontalSinc.	Horisontal synk.	15-100 KHz
Vertical sync.	Verticalfrequenz	Sync. verticale	Sinc. vertical	Sinc. vert.	VerticalSinc.	Vertikal synk.	43.5-130 Hz
Computer input	Computereingang	Entrée ordinateur	Entrada de señal del ordenador	Ingresso computer	Entrada Computador	Datamaskin-inngang	0.5-1 Vpp
Audio input	Audioeingang	Entrée audio	Entrada de audio	Ingresso audio	Entrada de áudio	Lydinggang	1 VRMS
Speakers	Lautsprecher	Haut-parleurs	Altavoces	Altoparlanti	Alto-falantes	Høytalere	2x1 W
Conformance	Prüfzeichen	Conformité	Homologación	Conformità	Conformidade	Oppfyller kravene til	CE. UL. CUL. GOST R. FCC, Subpart J, Part 15.
Power supply	Stromversorgung	Alimentation électrique	Suministro de corriente	Alimentazione elettrica	Fonte de alimentação	Strømforsyning	100-240 VAC, 50-60 HZ 2.5-1 A
Computer compatibility resized to native pixel resolution	Computer-kompatibilität. Resizing auf Originalauflösung (Pixel)	Compatibilité ordinateur au redimensionnement de la résolution d'origine (pixels)	Compatibilidad del ordenador ajustada a la resolución pixels. Resolución en pixels	Compatibilità computer (riclassificata in base alla risoluzione pixel originaria)	Compatibilidade do computador ajustada à resolução de origem (pixels)	Datamaskin-kompatibilitet, størrelse endret til naturlig pikseloppløsning	640x480 720x400 800x600 832x624 1024x768 1152x864 1152x870 1280x1024
Video compatibility	Videokompatibilität	Compatibilité vidéo	Compatibilidad de video	Compatibilità video	Compatibilidade de vídeo	Video-kompatibilitet	PAL BGHI, N, combination N, M, NTSC M, N, 4.43, Japan, SECAM

Subject to change Änderungen vorbehalten  
 Sous réserve a possibles modifications Sujetos a posibles cambios  
 Soggetti a modifica Sujeito a modificações  
 Kan endres

PROJECTION DISTANCES	PROJEKTIONS- ABSTÄNDE	DISTANCES DE PROJECTION	DISTANCIAS DE PROYECCIÓN	DISTANZE DI PROIEZIONE	DISTÂNCIAS DE PROJEÇÃO	PROJEKSJONS- AVSTANDER	
WIDE	WEITWINKEL	GRAND ANGULAIRE	GRAN ANGULAR	GRANDANGOLO	GRÃ ANGULAR	VIDVINKEL	
Distance	Entfernung	Distancia	Distancia	Distanza	Distância	Avstand	1.1-10m/3.6-32.5 ft.
Diagonal	Diagonale	Diagonal	Diagonale	Diagonale	Diagonale	Diagonal	0.7-6.5m/2.3-21.1 ft.
Width	Breite	Largeur	Ancho	Larghezza	Largura	Bredde	0.6-5.2m/1.9-16.9 ft.
Height	Höhe	Hauteur	Alto	Altezza	Altura	Høyde	0.5-3.9m/1.6-12.7 ft.
TELE	TELEOBJEKTIV	TELEOBJECTIF	TELEOBJETIVO	TELEOBIETTIVO	TELEOBJETIVA	TELE	
Distance	Entfernung	Distancia	Distancia	Distanza	Distância	Avstand	1.1-10m/3.6-32.5 ft.
Diagonal	Diagonale	Diagonal	Diagonale	Diagonale	Diagonale	Diagonal	0.6-5.2m/1.9-16.9 ft.
Width	Breite	Largeur	Ancho	Larghezza	Largura	Bredde	0.5-4.2m/1.6-13.7 ft.
Height	Höhe	Hauteur	Alto	Altezza	Altura	Høyde	0.35-3.2m/1.1-10.4 ft.

Variation of +/- 10% Abweichung von +/- 10%  
 Variation de +/- 10% Variazione di +/- 10%  
 Variação de +/- 10% Variação de +/- 10%  
 Varisjon på +/- 10%

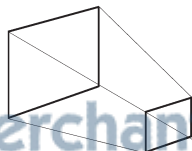

Discount-Merchant.com (800) 281-8860  
 THE TRUSTED SOURCE FOR PROJECTOR LAMPS AND ACCESSORIES



CONNECTORS    **ANSCHLÜSSE**    CONNECTEURS    **CONECTORES**    CONNETTORI    **CONECTORES**    KONTAKTER

2

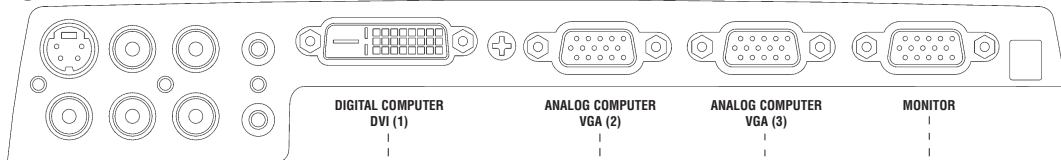

S-VIDEO VIDEO	AUDIO IN	AUDIO OUT	AUDIO (1)(2) IN (3)
3.5 mm JACK			
TIP: right			
RING: left			
STEM: common			
4 PIN MINIDIN FEMALE	3.5 mm JACK		
1 GND	TIP: right		
2 GND	RING: left		
3 Luma	STEM: common		
4 Chroma			
PHONO/RCA FEMALE	3.5 mm JACK		
STEM: composite SHIELD: GND	TIP: right		
	RING: left		
	STEM: common		

**DIGITAL COMPUTER DVI (1)**

DVI-D MAIN PIN FIELD

- 1 TMDS Data 2-
- 2 TMDS Data 2+
- 3 TMDS Data 2/4 Shield
- 4 Not used
- 5 Not used
- 6 DDC Clock
- 7 DDC Data
- 8 Analog Vertical Sync
- 9 TMDS Data 1-
- 10 TMDS Data 1+
- 11 TMDS Data 1/3 Shield
- 12 Not used
- 13 Not used
- 14 +5V Power
- 15 Ground (+5, Analog HV Sync.)
- 16 Hot Plug Detect
- 17 TMDS Data 0-
- 18 TMDS Data 0+
- 19 TMDS Data 0/5 Shield
- 20 Not used
- 21 Not used
- 22 TMDS Clock Shield
- 23 TMDS Clock+
- 24 TMDS Clock-

**ANALOG COMPUTER VGA (2)**

15 HIGH DENSITY DSUB FEMALE

- 1 Analog R in
- 2 Analog G in
- 3 Analog B in
- 4 AGND
- 5 AGND
- 6 Analog R GND in
- 7 Analog G GND in
- 8 Analog B GND in
- 9 Reserved
- 10 Sync GND in
- 11 AGND
- 12 DDC/SDA
- 13 HSync in
- 14 VSync in
- 15 DDC/SCL

**ANALOG COMPUTER VGA (3)**

15 HIGH DENSITY DSUB FEMALE

- 1 Analog R in
- 2 Analog G in
- 3 Analog B in
- 4 AGND
- 5 AGND
- 6 Analog R GND in
- 7 Analog G GND in
- 8 Analog B GND in
- 9 Reserved
- 10 Sync GND in
- 11 AGND
- 12 DDC/SDA
- 13 HSync in
- 14 VSync in
- 15 DDC/SCL

**MONITOR**

15 HIGH DENSITY DSUB FEMALE

- 1 Analog R OUT
- 2 Analog G OUT
- 3 Analog B OUT
- 4 Reserved
- 5 AGND
- 6 Analog R GND OUT
- 7 Analog G GND OUT
- 8 Analog B GND OUT
- 9 Reserved
- 10 Sync GND OUT
- 11 Not used
- 12 Not used
- 13 HSync OUT
- 14 VSync OUT
- 15 DDC/SCL

1

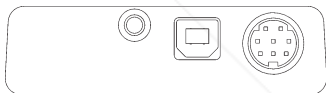

REMOTE CONTROL	MOUSE 2	MOUSE 1
2.5 MM JACK		8 PIN MINIDIN FEMALE
TIP: right		1 Mac ADB
RING: left		2 PS/2 clock
STEM: common		3 PS/2 data
		4 RS 232 TXD
		5 Not used
		6 RS 232 RXD
		7 RS 232 CTS
		8 GND
		DIGITAL USB
		1 VCC
		2 -Data
		3 +Data
		4 GND

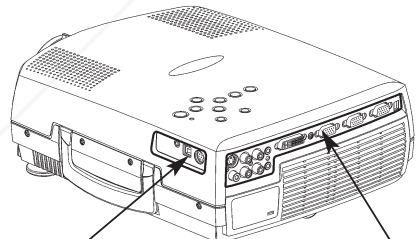

FixYourDLP.com  
Sponsored by DLP

Discount-Merchant.com (800) 281-8860  
THE TRUSTED SOURCE FOR PROJECTOR LAMPS AND ACCESSORIES

**⚠ This product contains no user serviceable parts. Attempts to modify mechanics or electronics inside the housing will violate any warranties, and may be hazardous.**

If for any reason the product fails to work properly, please contact your dealer for technical support. Prepare a list of the symptoms you observe to make diagnosing easier for your dealer.

Please also include the following:

- Serial number of the unit (SN)
- Part number of the unit (PN)
- Software revision (under Main Menu selection ADVANCED/SERVICE/INFO)
- Connected source information (under main menu selection HELP).

**⚠ Dieses Gerät enthält keine Verschleißteile. Der Versuch, elektronische oder mechanische Komponenten im Gehäuse zu manipulieren führt zum Verlust der Garantie und kann eine Gefahr für den Benutzer darstellen.**

Sollte das Gerät aus welchem Grund auch immer nicht korrekt funktionieren, wenden Sie sich bitte an Ihren Händler. Bitte halten Sie die auftretenden Probleme schriftlich fest. Damit erleichtern Sie Ihrem Händler die Fehlerdiagnose.

Bitte halten Sie auch folgende Daten bereit:

- Seriennummer des Geräts (SN)
- Teilnummer des Geräts (PN)
- Versionsnummer der Software (im Hauptmenü unter OPTIONEN/SERVICE/INFO)
- Information über angeschlossene Quelle (im Hauptmenü unter HILFE)

**⚠ Aucune des pièces de ce produit n'est réparable par l'utilisateur. Les tentatives de modification des parties mécaniques ou électroniques de l'appareil annuleront toute garantie et peuvent être dangereuses.**

Si le produit ne fonctionnait pas correctement, prenez contact avec votre concessionnaire. Préparez au préalable une liste des symptômes que vous avez observés pour que votre concessionnaire établisse plus aisément le diagnostic.

Veillez inclure les renseignements suivants:

- Numéro de série de l'unité (SN)
- Numéro de la pièce de l'unité (PN)
- Révision du logiciel (Sélectionnez ADVANCED/SERVICE/INFO dans le menu principal)
- Les renseignements concernant la source connectée (sélectionnez HELP dans le menu principal)

**⚠ Este producto no contiene ninguna pieza útil para el usuario. Cualquier intento de modificar la mecánica o electrónica incluida en la carcasa anulará la garantía, y puede resultar peligroso.**

Si por cualquier motivo el producto no funciona correctamente, póngase en contacto con su distribuidor para obtener asistencia técnica. Prepare una lista de los problemas que haya observado para facilitar su diagnóstico.

Incluya además los siguientes datos:

- Número de serie de la unidad (SN)
- Número de pieza de la unidad (PN)
- Revisión de software (consultar seleccionando AVANZANDO/SERVICIO/INFO en el menú principal)
- Información sobre fuentes conectadas (en AYUDA del menú principal)

**⚠ Questo prodotto non contiene parti sostituibili dall'utente. Qualsiasi tentativo di modificare parti meccaniche o elettroniche interne alla scatola renderà nulla la garanzia e può risultare pericoloso.**

Se per qualsiasi motivo il prodotto non funziona adeguatamente, si prega di contattare il rivenditore per l'assistenza tecnica. Preparare una lista dei sintomi osservati per rendere più facile la diagnosi al rivenditore.

Si prega anche di includere le seguenti informazioni:

- Numero di serie dell'apparecchiatura (SN)
- Numero del pezzo dell'apparecchiatura (PN)
- Revisione del software (vedere nel menu principale alla selezione ADVANCED/SERVICE/INFO)
- Informazioni sulla sorgente collegata (vedere nel menu principale alla selezione HELP)

**⚠ Este produto não contém peças úteis ao usuário. Tentativas de modificação da mecânica ou eletrônica interna violará qualquer garantia e pode ser perigoso.**

Se por qualquer razão o produto não funcionar corretamente, por favor contate o distribuidor para suporte técnico. Prepare uma lista dos sintomas observados a fim de facilitar o diagnóstico para o distribuidor.

Por favor também inclua o seguinte:

- Número de série da unidade (SN)
- Número da peça da unidade (PN)
- Revisão do software (no menu principal - seleção AVANÇADO/SERVICO/INFO)
- Informação da fonte conectada (no menu principal - seleção AJUDA)

Sponsored by 

**⚠ Dette produktet inneholder ingen deler som brukerne kan utføre service på. Forsøk på å endre mekaniske eller elektroniske komponenter innenfor dekslet vil gjøre alle garantier ugyldige, og kan også være farlig.**

Hvis produktet av en eller annen grunn ikke virker som det skal, må du kontakte forhandleren for å få teknisk brukerstøtte. Lag en liste over symptomene du ser, slik at det blir lettere for forhandleren å finne ut hva problemet skyldes.

Ta også med følgende:

- Enhetens serienummer (SN)
- Enhetens delenummer (PN)
- Programvareversjon (under hovedmenyvalget ADVANCED/SERVICE/INFO)
- Informasjon om tilkoblede kilder (under hovedmenyvalget HELP)

1. Remove foot and screw to access the dustfilter  
Fuß und Schraube entfernen, um an den Staubfilter zu gelangen  
Enlevez les pieds et les vis pour accéder au filtre à poussière  
Retire el pie y el tornillo para acceder al filtro del polvo  
Togliere la base avvitata per accedere al filtro della polvere  
Remove o pé e o parafuso para aceder ao filtro do pó  
Fjern foten og festeskruen for tilgang til støvfilteret

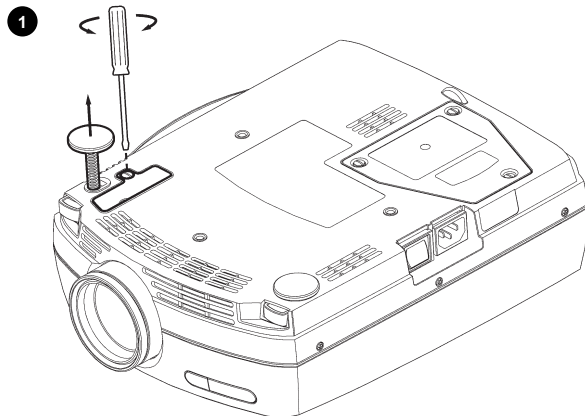

2. Carefully remove the dustfilter  
Staubfilter vorsichtig entfernen  
Enlevez le filtre à poussière avec précautions  
Retire con cuidado el filtro del polvo  
Togliere attentamente il filtro della polvere  
Remove cuidadosamente o filtro do pó  
Forsiktig fjern støvfilteret

3. Clean dustfilter  
Staubfilter reinigen  
Nettoyez le filtre à poussière  
Limpie el filtro del polvo  
Pulire il filtro della polvere  
Limpe o filtro do pó  
Rens støvfilteret

4. Replace clean dustfilter, tighten screw and replace foot  
Gereinigten Staubfilter wieder einlegen, Schrauben festziehen und Fuß anbringen  
Remettez le filtre à poussière en place, serrez les vis et remplacez les pieds  
Coloque de nuevo el filtro del polvo limpio, apriete el tornillo e instale el pie  
Sostituire il filtro della polvere pulito, avvitare bene e collocare nuovamente la base  
Coloque o filtro do pó limpo, aperte o parafuso e substitua o pé  
Sett tilbake rent støvfilter, stram festeskruen og sett tilbake foten

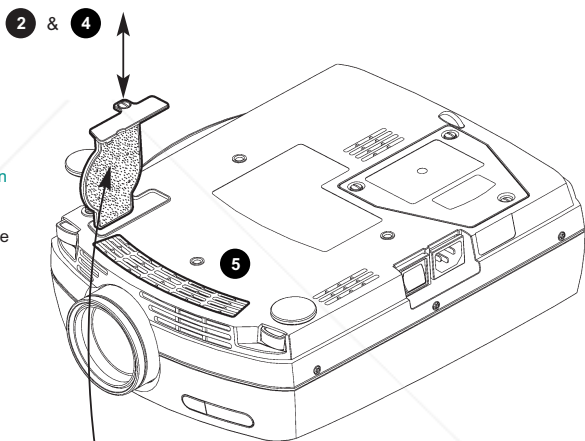

5. Clean all air intakes  
Alle Lufteinlässe reinigen  
Nettoyez toutes les entrées d'air  
Limpie todas las tomas de aire  
Pulire tutte le prese d'aria  
Limpe todas as entradas de admissão do ar  
Rens alle luft innsug

- ⚠ Clean dustfilter regularly for sufficient air flow  
Staubfilter regelmäßig reinigen, um eine ausreichende Luftzufuhr zu gewährleisten  
Nettoyez régulièrement le filtre à poussière pour assurer un flux d'air suffisant  
Limpie con regularidad el filtro del polvo para que se produzca la suficiente circulación del aire  
Pulire regolarmente il filtro della polvere per consentire un flusso dell'aria sufficiente  
Limpe regularmente o filtro do pó para obter um fluxo de ar suficiente  
Rens støvfilteret jevnlig for god luftgjennomstrømning

3



Discount-Merchant.com (800) 281-8860  
THE TRUSTED SOURCE FOR PROJECTOR LAMPS AND ACCESSORIES



Change lamp when lifetime expired. Replace expired lamp only with same type and rating

**Lampe nach Ablauf der Lebensdauer austauschen. Nur Lampen gleicher Art und Stärke verwenden**

Changez la lampe lorsque sa durée de vie arrive à expiration. Ne remplacez la lampe que par une lampe ayant les mêmes caractéristiques.

**Cambie la lámpara al término de su vida útil. Sustituya siempre la lámpara gastada por otra del mismo tipo y capacidad**  
 Sostituire la lampada quando termina la sua vita utile. Sostituire la lampada utilizzando unicamente una della stesso tipo e caratteristiche  
**Troque a lâmpada quando o tempo útil de vida expirar. Substitua a lâmpada gasta somente por outra do mesmo tipo e valor nominal**  
 Skift lampe når levetiden er overskredet. Bruk kun lampe av samme t type og med samme effekt



Disconnect power

**Netzstecker ziehen**

**Débranchez l'appareil**

**Desconecte la corriente**

**Scollegare l'alimentazione**

**Desligue a alimentação**

**Trekk ut strømledningen**



Reset lamp timer

**Betriebsstundenzähler auf Null setzen**

**Remettez le compteur de la lampe à zéro**

**Reinicie el temporizador de la lámpara**

**Azzerare il temporizzatore della lampada**

**Etetue o reinicio do temporizador da lâmpada**

**Tilbakestill telleverket for lampen**



1. Open screws on lamp housing  
**Schrauben des Lampengehäuses öffnen**  
 Dévissez les vis du logement de la lampe  
**Abra los tornillos del alojamiento de la lámpara**  
 Svitare le viti della sede della lampada  
**Desaperte os parafusos do alojamento da lâmpada**  
 Løse skruene til lampeholderen
2. Carefully pull out and remove lamp housing  
**Lampengehäuse vorsichtig herausnehmen**  
 Tirez avec précautions sur le logement de la lampe pour l'enlever  
**Extraiga con cuidado el alojamiento de la lámpara**  
 Tirare attentamente verso fuori e togliere la sede della lampada  
**Puxe cuidadosamente para fora e remova o alojamento da lâmpada**  
 Forsiktig fjern lampeholderen
3. Insert new lamp housing  
**Neues Lampengehäuse einsetzen**  
 Posez le nouveau logement de la lampe  
**Introduzca el nuevo alojamiento de la lámpara**  
 Inserire la nuova sede della lampada  
**Insira um novo alojamento da lâmpada**  
 Sett tilbake ny lampeholder
4. Tighten screws  
**Schrauben festziehen**  
 Serrez les vis  
**Apriete los tornillos**  
 Avvitare le viti  
**Aperte os parafusos**  
 Stram skruene

5. Check filter pad  
**Filter überprüfen**  
 Vérifiez le tampon filtre  
**Examine la almohadilla del filtro**  
 Controllare il tampone del filtro  
**Controllar filter**

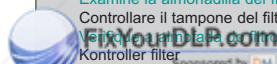

Sponsored by DM

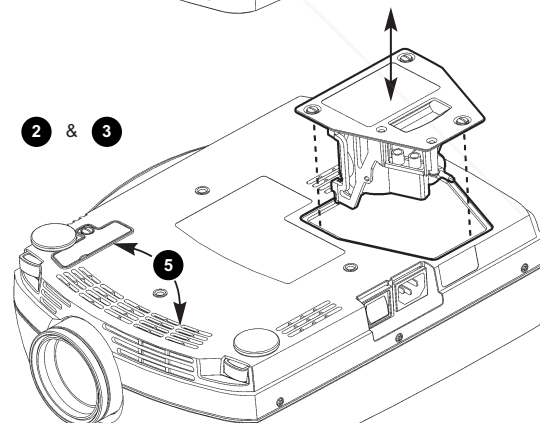
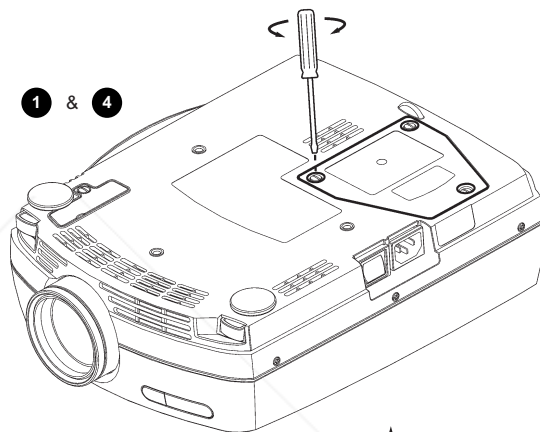

Refer service to qualified personnel only

**Service nur von qualifiziertem Personal durchführen lassen**

**Ne confiez l'entretien qu'à du personnel qualifié**

**Confie el mantenimiento solamente a personal cualificado**

**Affidare la manutenzione solo a personale qualificato**

**Remeta a assistência somente a pessoal qualificado**

**All service må overlates til kvalifisert personell**





This equipment complies with the limits for a Class A computing device, pursuant to Subpart J of Part 15 of FCC rules. Only peripherals (computer input/output devices, terminals, printers, etc.) certified to comply with the Class A limits may be attached to a computer that complies with Class A limits. When connecting to a peripheral device, a shielded input/output cable is required to ensure compliance with FCC rules. The shielded cable that must be used is supplied with the equipment. Operation with non-certified peripherals or non-shielded cables is likely to result in interference to radio and TV reception.

This equipment generates and uses radio-frequency energy and, if not installed and used in accordance with the instruction manual, may cause interference to radio and television reception. It has been tested and found to comply with the limits for a Class A computing device in accordance with the specifications in Subpart J of Part 15 of the FCC rules, which are designed to provide reasonable protection against such interference when operated in a commercial environment. However, there is no guarantee that interference will not occur in a particular installation. If this equipment does cause interference to radio or television reception, which can be determined by turning the equipment off and on, the user is encouraged to try to correct the interference by one or more of the following measures:

- Reorient the receiving antenna.
- Relocate the projector with respect to the receiver.
- Plug the equipment to a different outlet so that equipment and receiver are on different branch circuits.
- Fasten cables using mounting screws to ensure adequate EMI control.

You may require the following booklet from the Federal Communications Commission (FCC): "How to identify and resolve radio and TV interference problems", available from the U.S. Government Printing Office, Washington, DC 20402, Stock No. 004-000-00345-4.



**Discount-Merchant.com (800) 281-8860**  
**THE TRUSTED SOURCE FOR PROJECTOR LAMPS AND ACCESSORIES**



# Disclaimer

This user manual is provided as a free service by FixYourDLP.com. FixYourDLP is in no way responsible for the content of this manual, nor do we guarantee its accuracy. FixYourDLP does not make any claim of copyright and all copyrights remain the property of their respective owners.

About FixYourDLP.com

FixYourDLP.com (<http://www.fixyourdpl.com>) is the World's #1 resource for media product news, reviews, do-it-yourself guides, and manuals.

Informational Blog: <http://www.fixyourdpl.com>

Video Guides: <http://www.fixyourdpl.com/guides>

User Forums: <http://www.fixyourdpl.com/forum>

FixYourDLP's Fight Against Counterfeit Lamps:

<http://www.fixyourdpl.com/counterfeits>

## Sponsors:

RecycleYourLamp.org – Free lamp recycling services for used lamps:

<http://www.recycleyourlamp.org>

Lamp Research - The trusted 3rd party lamp research company:

<http://www.lampresearch.com>

Discount-Merchant.com – The worlds largest lamp distributor:

<http://www.discount-merchant.com>



**FixYourDLP.com**

Sponsored by 