



# Disclaimer

This user manual is provided as a free service by FixYourDLP.com. FixYourDLP is in no way responsible for the content of this manual, nor do we guarantee its accuracy. FixYourDLP does not make any claim of copyright and all copyrights remain the property of their respective owners.

About FixYourDLP.com

FixYourDLP.com (<http://www.fixyourdpl.com>) is the World's #1 resource for media product news, reviews, do-it-yourself guides, and manuals.

Informational Blog: <http://www.fixyourdpl.com>

Video Guides: <http://www.fixyourdpl.com/guides>

User Forums: <http://www.fixyourdpl.com/forum>

FixYourDLP's Fight Against Counterfeit Lamps:

<http://www.fixyourdpl.com/counterfeits>

## Sponsors:

RecycleYourLamp.org – Free lamp recycling services for used lamps:

<http://www.recycleyourlamp.org>

Lamp Research - The trusted 3rd party lamp research company:

<http://www.lampresearch.com>

Discount-Merchant.com – The worlds largest lamp distributor:

<http://www.discount-merchant.com>



**FixYourDLP.com**

Sponsored by 

# USER GUIDE

*multimedia projector* | **C20 SVGA / C60 XGA**



English  
Deutsch  
Français  
Español  
Italiano  
Português  
Norsk

 FixYourDLP.com  
Sponsored by 

**Discount-Merchant.com (800) 281-8880**

THE TRUSTED SOURCE FOR PROJECTOR LAMPS AND ACCESSORIES



|  |           |
|--|-----------|
| <b>A. SUPPLIED MATERIAL,</b> LIEFERUMFANG, EQUIPEMENT FOURNI, MATERIAL SUMINISTRADO, MATERIALE FORNITO, MATERIAL FORNECIDO, VEDLAGT MATERIELL  | <b>4</b>  |
| <b>B. OVERVIEW,</b> ÜBERSICHT, PRESENTATION, VISTA GENERAL, PROSPETTO, VISTA GERAL, OVERSIKT   | <b>5</b>  |
| <b>C. SETTING UP PROCEDURE,</b> ANSCHLUSS, INSTALLATION, PROCEDIMIENTO DE CONEXIÓN, PROCEDIMENTO DI IMPOSTAZIONE, INSTALAÇÃO, OPPSETT  | <b>6</b>  |
| <b>D. CEILING MOUNT, DECKENMONTAGE,</b> MONTAGE AU PLAFOND, MONTAJE EN EL TECHO, MONTAGGIO A SOFFITTO, MONTAGE DE TETO, TAKMONTERING   | <b>8</b>  |
| <b>E. START - STOP,</b> START - STOP, ALLUMER/ÉTEINDRE, INICIO - PARADA, AVVIO - ARRESTO, LIGAR - DESLIGAR, START - STOPP  | <b>9</b>  |
| <b>F. IMAGE ADJUSTMENTS,</b> BILDEINSTELLUNGEN, MISE AU POINT DE L'IMAGE, AJUSTE DE LA IMAGEN, REGOLAZIONE DELL'IMMAGINE, AJUSTES DA IMAGEM, JUSTERE BILDET  | <b>10</b> |
| <b>G. REMOTE CONTROL &amp; KEYPAD,</b> FERNBEDIENUNG UND BEDIENTELD, TELECOMMANDE ET CLAVIER, CONTROL REMOTO Y TECLADO, TELECOMANDO E TASTIERA, CONTROLE REMOTO E TECLADO, FJERNKONTROLL OG TASTATUR         | <b>11</b> |
| <b>H. MENU ADJUSTMENTS,</b> MENÜ EINSTELLUNGEN, OPTIONS DE MENU, MENÜ DE AJUSTES, IMPOSTAZIONI DAL MENU, AJUSTES DO MENU, MENYINNSTILLINGER  | <b>14</b> |
| <b>I. LIGHT MESSAGES,</b> LEUCHTANZEIGEN, INDICATEURS LUMINEUX, INDICADORES LUMINOSOS, MESSAGGI LUMINOSI, INDICADORES LUMINOSOS, LYSIGNALER  | <b>21</b> |
| <b>J. POWER MANAGEMENT (DPMS),</b> POWER MANAGEMENT (DPMS), GESTION DE L'ALIMENTATION (DPMS), FUENTES DE ENERGIA (DPMS), CONTROLLO DELL'OPERATIVITÀ (DPMS), CONTROLE DA POTÊNCIA (DPMS), STRØMSPARING (DPMS) | <b>23</b> |
| <b>K. TROUBLESHOOTING,</b> FEHLERBEHEBUNG, SOLUTION AUX PROBLÈMES LES PLUS FRÉQUENTS, SOLUCIÓN DE PROBLEMAS, SOLUZIONE DEI PROBLEMI, LOCALIZAÇÃO DE DEFEITOS, FEILSØKING                                     | <b>24</b> |
| <b>L. TECHNICAL DATA,</b> TECHNISCHE DATEN, CARACTERISTIQUES TECHNIQUES, DATOS TÉCNICOS, DATI TECNICI, DADOS TÉCNICOS, TEKNISKE DATA   | <b>26</b> |
| <b>M. SERVICE INFORMATION,</b> SERVICEHINWEIS, RÉPARATIONS, INFORMACIÓN SOBRE ASISTENCIA TECNICA, ASSISTENZA TECNICA, INFORMAÇÃO DE SERVIÇOS, SERVICEINFORMASJON   | <b>29</b> |
| <b>MAINTENANCE,</b> WERTUNG, ENTRETIEN, MANTENIMIENTO, MANUTENZIONE, MANUTENÇÃO, VEDLIKEHOLD   | <b>30</b> |
| <b>O. LAMP REPLACEMENT,</b> LAMPENAUSTAUSCH, REMPLACEMENT DE LA LAMPE, SUSTITUCIÓN DE LA BOMBILLA, SOSTITUZIONE LAMPADINA, SUBSTITUIÇÃO DA LÂMPADA, LAMPESKIFT   | <b>31</b> |
| <b>P. FCC STATEMENT</b>  | <b>32</b> |



DiscountMerchant.com (800) 281-8860

**THE TRUSTED SOURCE FOR PROJECTOR LAMPS AND ACCESSORIES**

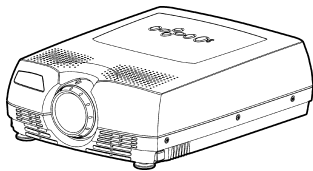

LCD Projector with lenscap  
 LCD Projektör mit Schutzkappe  
 Projecteur LCD avec protection lentille  
 Projectore LCD con tapa del lente  
 Proiettore LCD con coperschietto  
 Projektor LCD com protetor de lente  
 LCD-projektor med linsedekseil

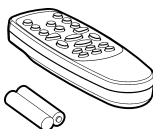

Remote control with batteries  
 Fernbedienung mit Batterien  
 Télécommande avec batteries  
 Control remoto con pilas  
 Telecomando con batterie  
 Controle remoto com pilhas  
 Fjernkontroll med batterier

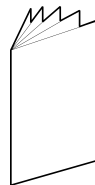

Product documentation  
 Produktunterlagen  
 Description du produit  
 Documentación del producto  
 Documentazione del Prodotto  
 Documentação do produto  
 Produktdokumentasjon

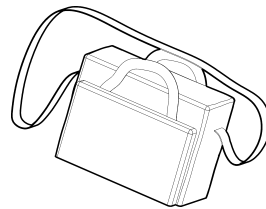

Soft Case  
 Tragetasche  
 Etui souple  
 Funda  
 Valigetta  
 Maleta  
 Myk veske

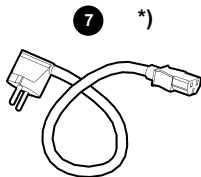

Power cord  
 Netzkabel  
 Cordon d'alimentation  
 Cable de alimentación  
 Cavo alimentazione  
 Cabo de alimentação  
 Strømfledning

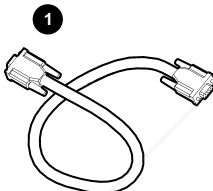

Computer Cable (VGA)  
 Computerkabel (VGA)  
 Câble d'ordinateur (VGA)  
 Cable informático (VGA)  
 Cavo per il computer (VGA)  
 Cabo do Computador (VGA)  
 Datamaskinkabel (VGA)

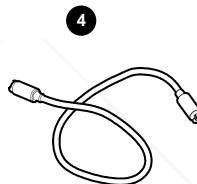

PS/2 Mouse Cable  
 PS/2 Maus kabel  
 PS/2 Câble souris  
 PS/2 Cable raton  
 PS/2 Cavo mouse  
 PS/2 Cabo de Mouse  
 PS/2 Musedkabel

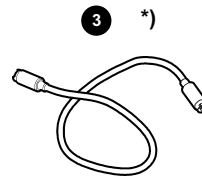

S-Video Cable  
 S-Video kabel  
 Câble S-Video  
 Cable de Video-S  
 Cavo S-Video  
 Cabo de S-Video  
 S-Video kabel

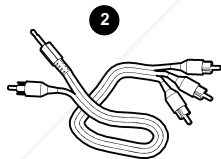

Audio/Video Cable  
 Audio/Video kabel  
 Câble audio/vidéo  
 Conexión de audio/video  
 Cavo audio/video  
 Cabo de Audio/Video  
 Audio/Video kabel

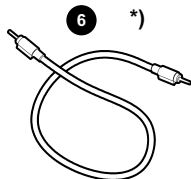

Audio Cable  
 Audiokabel  
 Câble audio  
 Cable de audio  
 Cavo audio  
 Cabo de Audio  
 Audiokabel

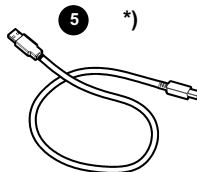

USB Mouse Cable  
 USB Maus kabel  
 Câble souris USB  
 Cable raton USB  
 Cavo mouse USB  
 Cabo de Mouse USB  
 USB-musedkabel

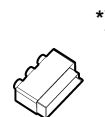

SCART adapter  
 SCART-Anschluß  
 Adaptateur SCART  
 Adaptador de SCART  
 Presa SCART  
 Adaptador SCART  
 SCART-adapter



FixYourDLP.com

Audio/Video Cable

Audio/Video kabel

Câble audio/vidéo

Conexión de audio/video

Cavo audio/video

Cabo de Audio/Video

Audio/Video kabel

Digitant-Merant.com (800) 242-360  
 THE TRUSTED SOURCE FOR PROJECTOR PARTS AND ACCESSORIES

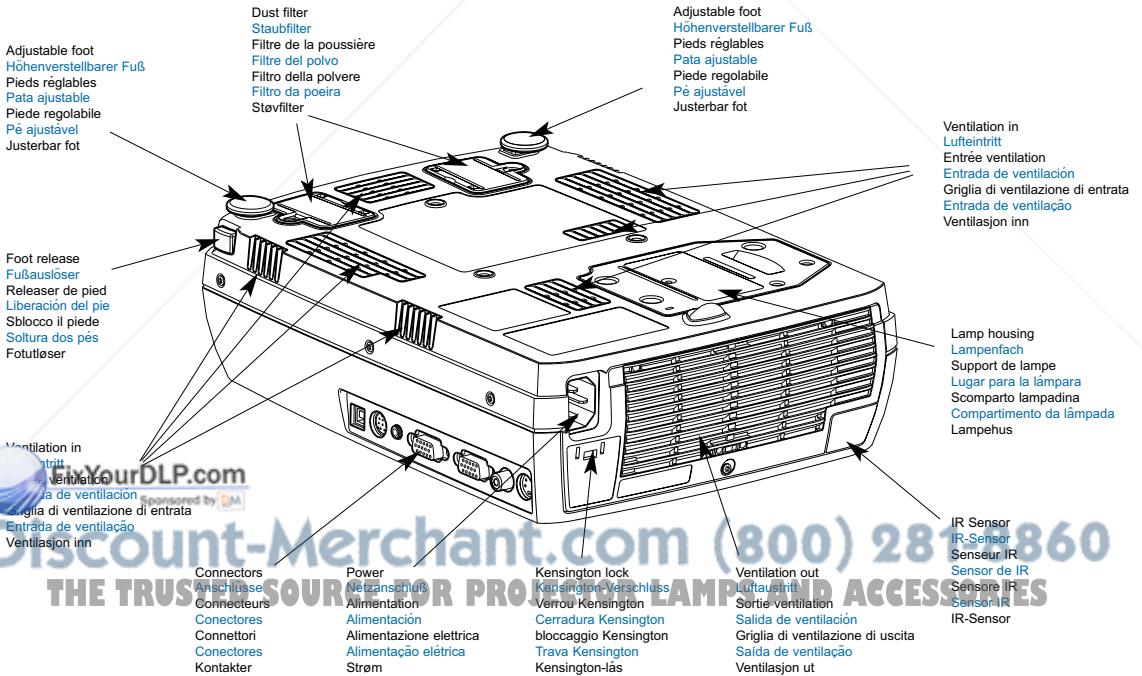
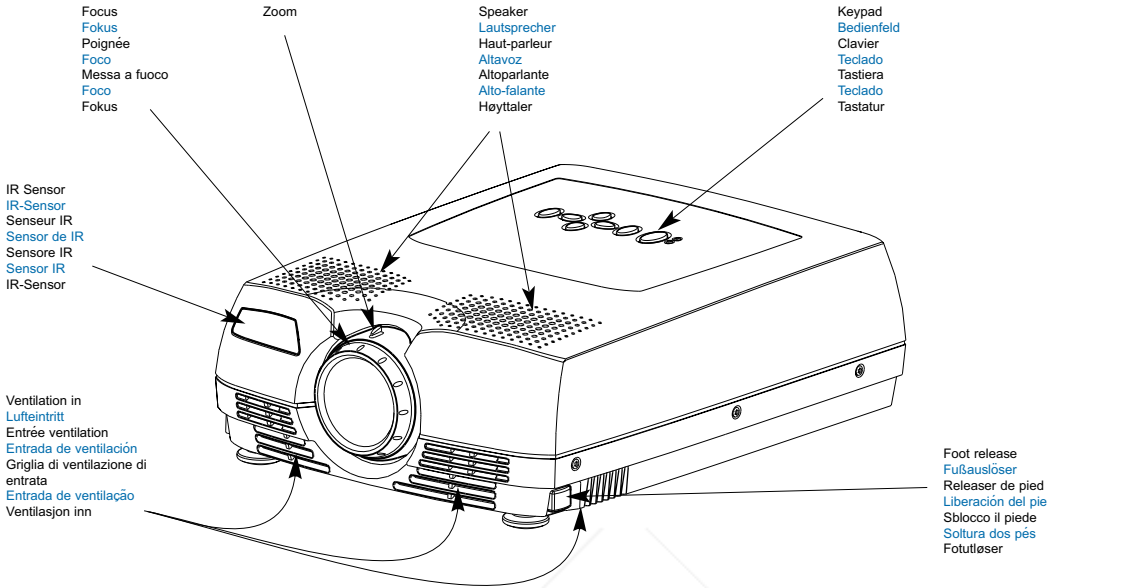

YourDLP.com
   
 Discount-Merchant.com
   
 THE TRUSTED SOURCE FOR PROJECTOR LAMP AND ACCESSORIES

1. Connect the projector to:
  - the Data source with the Computer Cable (VGA) (1)
  - the Video source with the Audio/Video Cable (2)
  - the S-Video source with the S-Video cable\* (3)
2. For mouse control, connect:
  - the PS2 cable (4) to the PS2/RS-232 or
  - the USB Mouse Cable\* (5) to USB
3. For computer sound connection, use the Audio Cable\* (6) to Audio in
4. Connect "Power Cord"\* (7) to the projector
5. Turn on the projector, then the source(s)

1. Anschließen des Projektors:
  - mit dem Computerkabel (VGA) (1) an die Datenquelle
  - mit dem Audio- / Videokabel (2) an die Videoquelle
  - mit dem S-Videokabel\* (3) an die S-Videoquelle
2. Für die Steuerung der Maus:
  - Anschluss des PS2 Kabels (4) an PS2/RS-232 oder
  - Anschluss des USB Maus Kabels\* (5) an USB
3. Für den Soundanschluss an den Computer verwenden Sie das Audiokabel\* (6) in Audio in
4. Anschließen des "Stromkabels"\* (7) an den Projektor
5. Schalten Sie den Projektor ein und danach die Quelle(n)

1. Brancher le projecteur à:
  - la source de données avec le câble de l'ordinateur (VGA) (1).
  - la source vidéo avec le câble audio/vidéo (2).
  - la source S-Vidéo avec le câble S vidéo\* (3).
2. Contrôle de la souris, brancher:
  - le câble de la souris PS2 (4) au port PS2/RS-232 ou
  - le câble de la souris USB\* (5) au port USB.
3. Pour brancher le son sur l'ordinateur, brancher le câble audio\* (6) sur Audio in
4. Brancher le projecteur avec le "cordon d'alimentation"\* (7).
5. Allumer d'abord le projecteur et brancher ensuite, la (ou les) source(s).

1. Conectar el proyector a:
  - la fuente de datos con el cable informático (VGA) (1)
  - la fuente de vídeo con el cable de audio/vídeo (2)
  - la fuente S-Video con el cable S-Video\* (3)
2. Para controlar el ratón, conecte:
  - el cable PS2 (4) al puerto PS2/RS-232 o
  - el cable de ratón USB\* (5) al puerto USB
3. Para la conexión del sonido en el ordenador, conecte el cable de audio\* (6) en Audio in
4. Conecte el cable de corriente\* (7) en el proyector
5. Encienda primero el proyector y después la fuente(s)

1. Collegare il proiettore a:
  - la fonte Dati con il Cavo Computer (VGA) (1)
  - la fonte Video con il cavo Audio/Video (2)
  - la fonte Video - S con il cavo\* S-Video (3)
2. Per il controllo del mouse, collegare:
  - il cavo PS2 (4) al PS2/RS-232 o
  - il cavo\* USB del Mouse (5) all' USB
3. Per il collegamento audio con il computer, impiegare il Cavo Audio\* (6) collegato a Audio in
4. Collegare il "Cavo di Alimentazione"\* (7) al proiettore
5. Accendere il proiettore, di seguito la fonte(i)

1. Ligue o projector:
  - à fonte de dados com o cabo do computador (VGA) (1)
  - à fonte de vídeo com o cabo de áudio/vídeo (2)
  - à fonte de S-Video com o cabo de S-Video\* (3)
2. Para controlo com o rato, ligue:
  - o cabo PS2 (4) à porta PS2/RS-232 ou
  - o cabo USB do rato\* (5) à porta USB
3. Para conexão de áudio no computador, utilize o cabo de áudio\* (6) em Audio in (Entrada De Áudio)
4. Conecte o cabo de alimentação\* (7) ao projector
5. Ligue o projector e as fontes

1. Koble projektoren til:
  - datakilden med Datamaskinkabelen (VGA) (1)
  - videokilden med Audio/Video-kabelen (2)
  - S-Videokilden med S-Videokabelen\* (3)
2. For musekontroll kobler du:
  - PS2-kabelen (4) til PS2/RS-232 eller
  - USB-musekabelen\* (5) til USB
3. Hvis du vil koble til lyd fra datamaskinen, kobles Audio-kabelen\* (6) til Audio in
4. Koble strømledningen\* (7) til projektoren
5. Slå på projektoren, og derefter kilden(e)



FixYourDLP.com

Sponsored by

Discount-Merch.com (800) 281-8860  
 THE USA PROJECTOR LAMPS AND ACCESSORIES

# SETTING UP PROCEDURE

ANSCHLUSS INSTALLATION PROCEDIMIENTO DE CONEXIÓN PROCEDIMENTO DI IMPOSTAZIONE INSTALACÃO OPPSETT

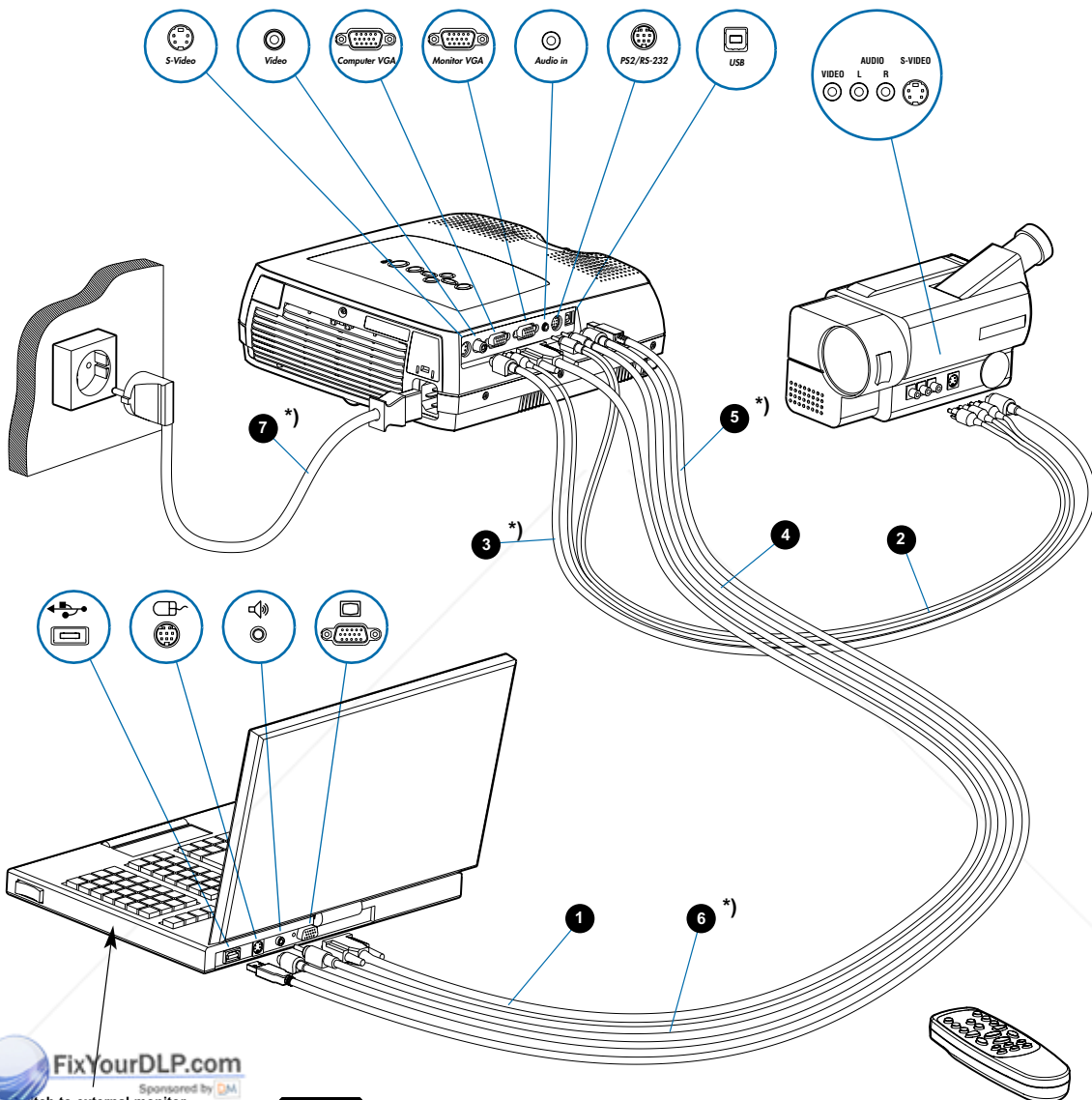

**FixYourDLP.com**  
Sponsored by 

**Switch to external monitor**  
Schalter für externen Monitor  
Commutateur pour écran autonome  
Enchufe para monitor externo  
Interruttore per monitor esterno  
Interruptor para monitor externo  
Bytt til ekstern skjerm



**Authorized Source for Projector Lamps and Accessories**  
**Merchant.com (800) 281-8860**

\*) Country dependent Länder abhängig Dépendant du pays Dependente del país Dipendentemente al paese di destinazione Dependendo do país Områdeavhengig

- ⚠** Ceiling mount (use M4 screw). Min. distance from ceiling/rear wall: 30/50 cm, 12/20 inch for proper ventilation  
**Deckenmontage (M4-Schrauben verwenden).** Mindestabstand von der Decke/rückwand 30/50 cm, damit eine korrekte Belüftung gewährleistet ist  
**Montage au plafond (utilisez un tournevis M4).** Distance minimum au plafond/mur arrière: 30/50 cm, pour garantir une ventilation adéquate  
**Soporte de techo (utilice un tornillo de M4).** Distancia mínima desde el techo/pared posterior: 30/50 cm, para que exista una ventilación correcta  
**Montaggio a soffitto (utilizzare viti da M4).** Distanza minima dal soffitto/muro posteriore 30/50 cm, per una ventilazione adeguata  
**Montagem de teto (use parafuso de M4).** Distância mín. teto/parede traseira: 30/50 cm, para uma ventilação adequada  
**Takbeslag (bruk M4 skruer).** Min. distanse fra tak/bakvegg: 30/50 cm, 12/20 tommer, for å få tilstrekkelig ventilasjon

- ⚠** To avoid personal injury, use only approved ceiling mount. Ref. Chap. L  
**Um Verletzungen zu vermeiden, nur autorisierte Deckenaufhängungen verwenden.** Siehe Kap. L  
**Utiliser exclusivement une fixation plafonnrière agréée afin de prévenir tout risque de dommage corporel.** Voir Chap. L  
**Para evitar daños personales, utilice únicamente el dispositivo de montaje en techo homologado.** Ref. Cap. L  
**Per evitare lesioni personali, utilizzare esclusivamente supporti per il montaggio al soffitto approvati.** Rif. Cap. L  
**Para evitar lesões pessoais, no tecto use apenas suporte autorizado.** Ref. Cap L  
**For å unngå personskader, bruk kun godkjent takbeslag.** Se Kap. L

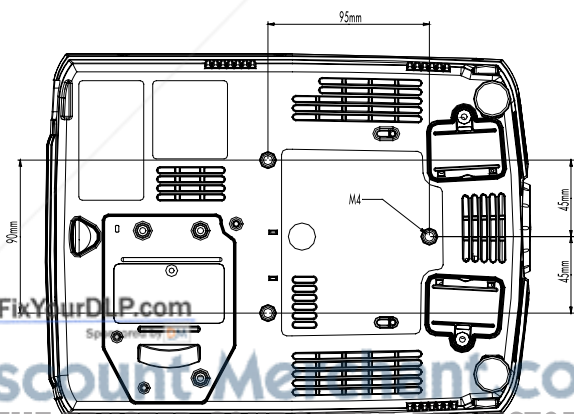
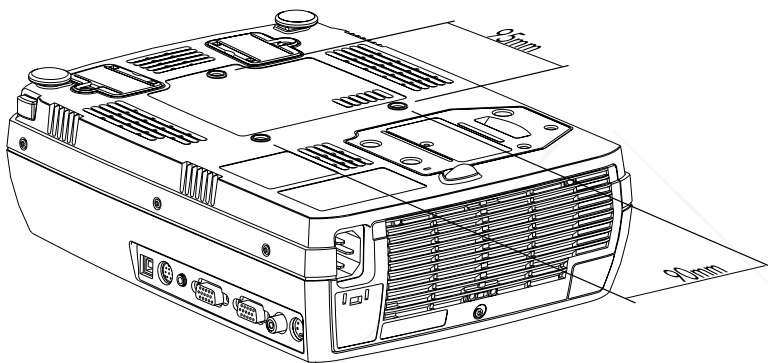



Install batteries  
Batterien einlegen  
Mettre des piles en place  
Colocar las baterías  
Inserimento pile  
Colocar as pilhas  
Sett inn batteriene

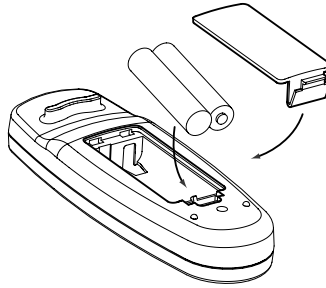

1

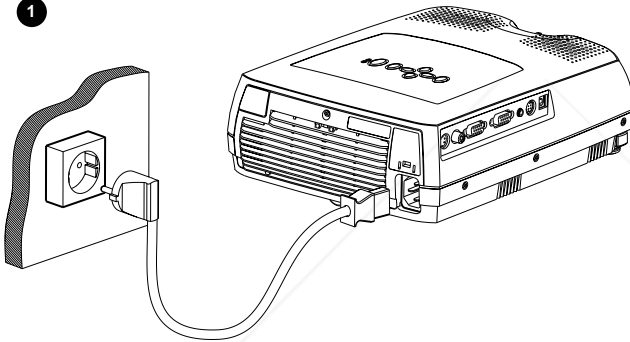

2

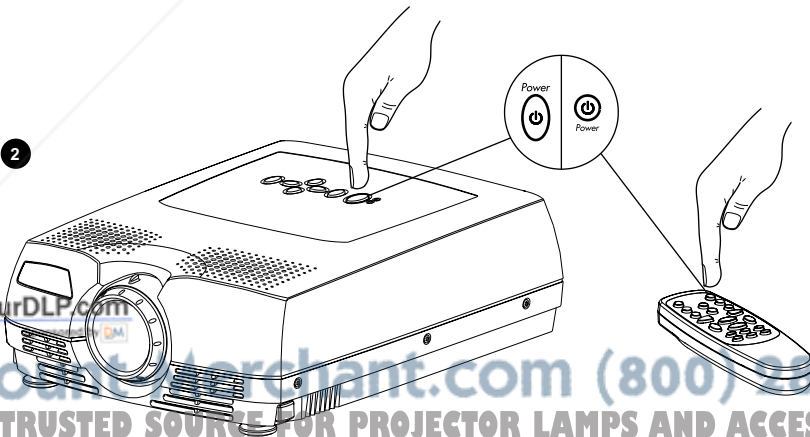

FixYourDLP.com

DiscountMerchant.com (800) 201-8860  
THE TRUSTED SOURCE FOR PROJECTOR LAMPS AND ACCESSORIES

1. Zoom: adjusts picture size  
 Zoom: Einstellen der Bildgröße  
 Zoom: règle les dimensions de l'image  
 Zoom: ajusta el tamaño de la imagen  
 Zoom: regola le dimensioni dell'immagine  
 Zoom: ajusta o tamanho da imagem  
 Zoom: justerer bildets størrelse

2. Focus: adjusts picture sharpness  
 Focus: Einstellen der Bildschärfe  
 Focus: règle la netteté de l'image  
 Focus: ajusta la claridad de la imagen  
 Focus: regola la messa a fuoco dell'immagine  
 Focus: ajusta a nitidez da imagem  
 Fokus: justerer bildets skarphet

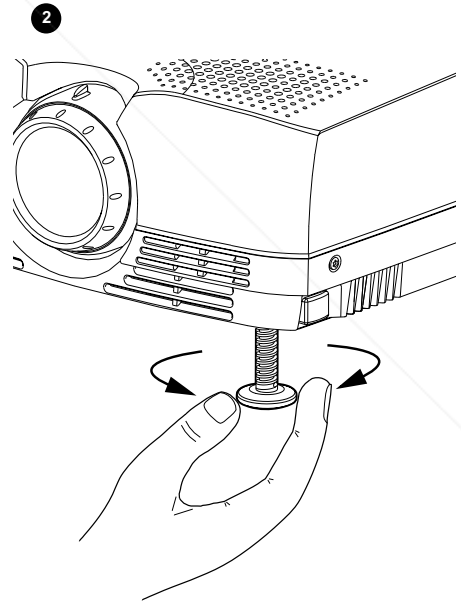
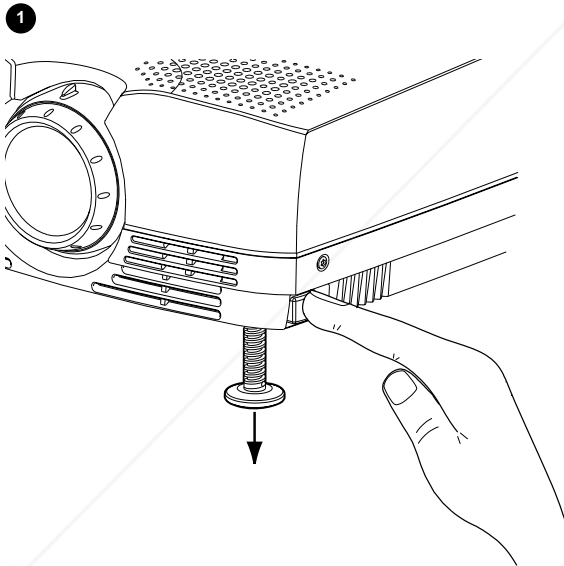
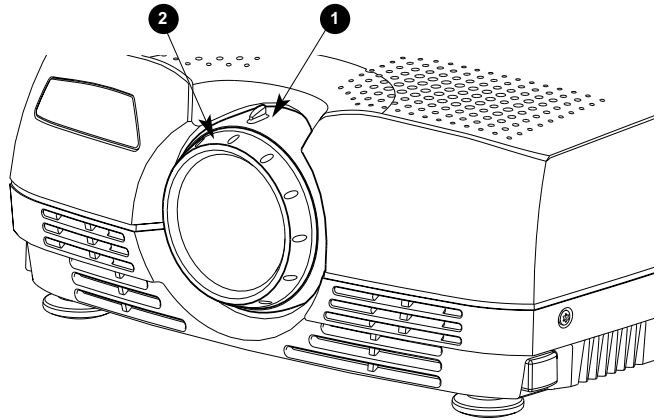

Release the projector's feet to adjust display angle (1) or manually adjust feet (2)

Fuß zur Einstellung des Projektionswinkels lösen (1) oder drehen (2)

Libérez les pieds du projecteur pour régler l'angle de projection (1) ou régler les pieds manuellement (2)

Libera la pata del proyector para ajustar el ángulo de presentación de imagen (1) o ajustar la pata manualmente (2)

Sblocca il piedi del proiettore per regolare l'angolazione dello schermo (1) o per regolare manualmente l'altezza dei piedi (2)

Solte os pés do projetor para ajustar o ângulo de exibição (1) ou ajuste os pés manualmente (2)

Frigjør projektorens føtter for å tilpasse visningsvinkelen (1), eller justere føttene manuelt (2)

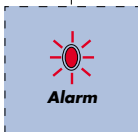
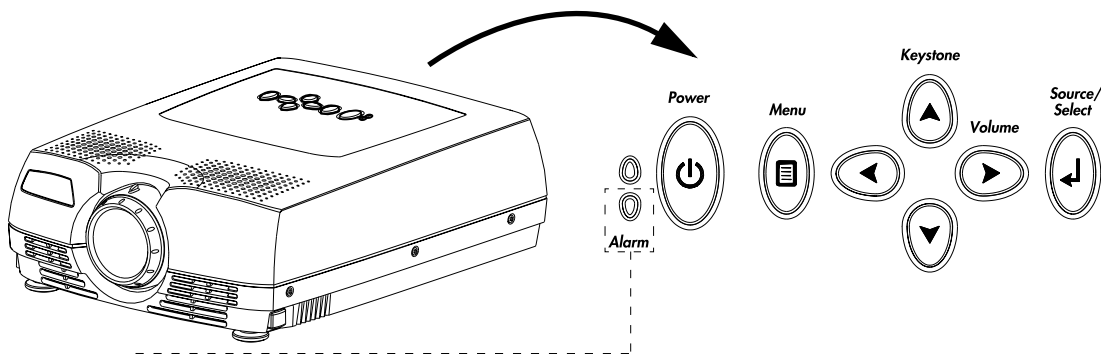

**RED light indicates lamp replacement required. Ref. O (LAMP REPLACEMENT)**

**Das ROTE Licht zeigt an, daß die Lampe ausgewechselt werden muß. Ref. O (LAMPENAUSTAUSCH)**

**La lumière ROUGE indique que la lampe doit être remplacée. Voir. O (REMPLACEMENT DE LA LAMPE)**

**La luz ROJA indica que se debe de reemplazar la bombilla. Ref. O (SUSTITUCIÓN DE LA BOMBILLA)**

**La luce ROSA indica che bisogna sostituire la lampadina. Rif. O (SOSTITUZIONE LAMPADINA)**

**A luz VERMELHA indica que a lâmpada deve ser substituída. Ref. O (SUBSTITUIÇÃO DA LÂMPADA)**

**RØDT lys angir at lampen må byttes ut. Se O (LAMPESKIFT)**

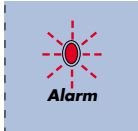

**RED FLASHING when the projector is overheated. Power off and let cool down**

**ROTES BLINKLICHT zeigt Überhitzung des Projektors an. Ausschalten und abkühlen lassen**

**Un CLIGNOTEMENT ROUGE signale la surchauffe du projecteur. Débrancher l'alimentation et laisser refroidir**

**LUZ ROJA PARPADEANTE cuando el proyector está sobrecalentado. Desconectar la alimentación y dejar enfriar**

**La luce ROSSA INTERMITTENTE indica che il proiettore si è surriscaldato. Scollegare l'alimentazione e lasciare raffreddare**

**A luz VERMELHA INTERMITENTE indica superaquecimento do projector. Desligar e deixar esfriar**

**RØDT BLINKENDE når projektoren er overopphetet. Slå av og la projektoren avkjøle seg**

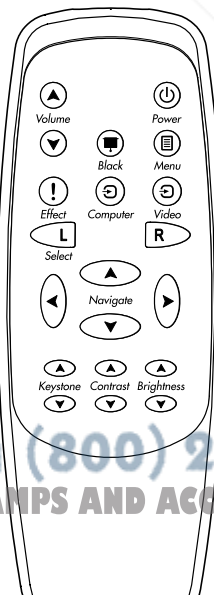
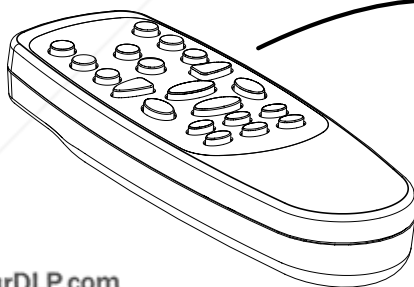

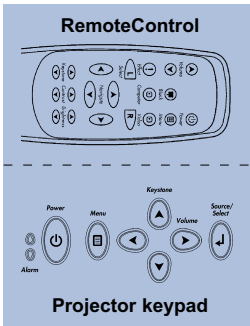

Activate by pressing actual key(s).  
**Zum Aktivieren jeweilige Taste(n) drücken.**  
**Aktiver en pressant la (les) touches correspondante(s).**  
**Activar pulsando la(s) tecla(s) indicativa(s).**  
**Attivare premendo il / i tasto / i attivi.**  
**Ativar pressionando a(s) tecla(s) correspondante(s).**  
**Aktiver ved å trykke på aktuell(e) tast(er).**

Turns the projector ON/OFF  
**Projektor ein-/ausschalten**  
**Allume (ON)/Eteint (OFF) le projecteur**  
**Encender (ON)/Apagar (OFF) el proyector**  
**Accensione del proiettore ON/OFF**  
**Liga e Desliga o projetor**  
**Slår projektoren PÅ/AV**

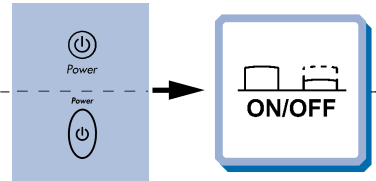
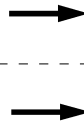

Adjust volume  
**Lautstärke einstellen**  
**Réglage du volumen**  
**Ajustar el volumen**  
**Regolazione del volume**  
**Ajusta o volume**  
**Juster lydstyrken**

Blackens the projected image  
**Bild verdunkeln**  
**Assombrir l'image**  
**Bajar la imagen proyectada a negro**  
**Oscuramento dell'immagine proiettata**  
**Preteja a imagem projetada**  
**Gjør bildet som vises sort**

Switch between connected sources  
**Zwischen angeschlossenen Geräten hin- und herschalten.**  
**Passage d'une source connectée à une autre source connectée.**  
**Commutar entre las fuentes conectadas**  
**Commutazione fra le sorgenti collegate**  
**Alterna entre as fontes conectadas**  
**Bytt mellom de tilkoblede kildene**

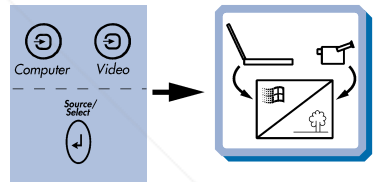
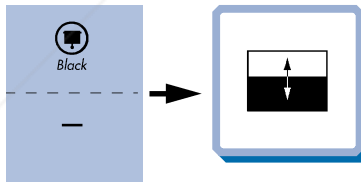
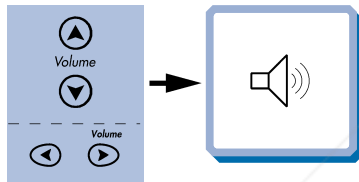

Adjust keystone angle  
**Winkel Trapezverzerrung einstellen**  
**Réglage de l'angle de la clef de voûte**  
**Ajustar el ángulo de distorsion de imagen**  
**Regolazione dell'angolo di distorsione**  
**Ajusta o ângulo trapezoidal**  
**Juster keystone-vinkelen**

Adjusts contrast range from 0-100  
**Kontrast von 0-100 einstellen**  
**Règle le contraste entre 0 et 100**  
**Ajusta el contraste entre 0-100**  
**Regolazione del contrasto da 0 a 100**  
**Ajusta o contraste de 0 a 100**  
**Justerer kontrasten innenfor området 0-100**

Adjusts brightness range from 0-100  
**Helligkeit von 0-100 einstellen**  
**Règle la luminosité entre 0 et 100**  
**Ajusta el brillo entre 0-100**  
**Regolazione della luminosità da 0 a 100**  
**Ajusta o brilho de 0 a 100**  
**Justerer lysstyrken innenfor området 0-100**

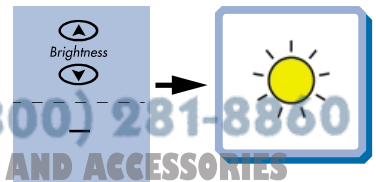
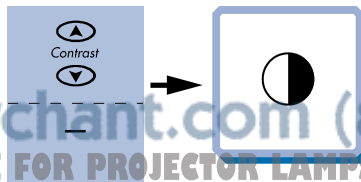

Activates/deactivates on screen menu (OSD)  
 Bildschirrmenu aktivieren/deaktivieren (OSD)  
 Active/Désactive le menu sur l'écran (OSD)  
 Activa/desactiva el menú en pantalla  
 Attivazione/disattivazione del menù sullo schermo  
 Ativa/desativa o menu da tela  
 Aktiverer/deaktiverer menyvisning på skjermen (OSD)

Scroll menu  
 Menüpunkte ansteuern  
 Menu déroulant  
 Desplegar menú  
 Scorrimento del menù  
 Desloque-se no menu  
 Gå gjennom menyen

Select on-screen menu function  
 Funktion des Bildschirrmenus aktivieren  
 Sélectionnez une fonction du menu sur l'écran  
 Seleccionar función de menú en pantalla  
 Selezione della funzione sul menu dello schermo  
 Selezione uma função no menu da tela  
 Velg aktuell funksjon i menyen på skjermen

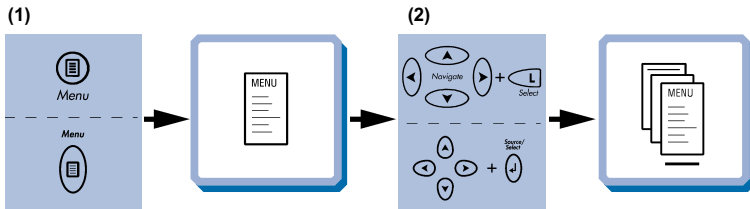
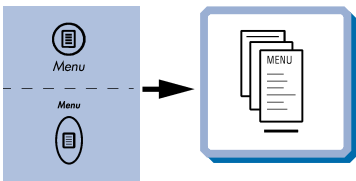

Mouse control (with PS2 Mouse Cable)  
 Steuerung der Maus (mit dem PS2 Maus kabel)  
 Contrôle de la souris (avec le câble de la souris PS2).  
 Control del ratón (con el cable para PS2)  
 Controllo del mouse (con Cavo Mouse PS2)  
 Controllo por rato (com cabo PS2)  
 Musekontroll (med PS2-musekabelen)

Press to instantly invoke the presentation effect assigned through the "Effects" menu  
 Drücken Sie, um unmittelbar den Präsentationseffekt aufzurufen, der über das Menü "Effects" eingestellt wurde  
 Appuyer pour faire apparaître les effets spéciaux disponibles assignés dans le menu "Effets"  
 Pulse para obtener, de forma inmediata, el efecto de presentación asignado mediante el menú "Efectos"  
 Premere per richiamare immediatamente l'effetto presentazione assegnato tramite il menu "Effetti"  
 Aperte para obter instantaneamente o efeito da apresentação determinado através do menu "Efeitos"  
 Trykkes når du vil ta i bruk presentasjonseffekten som er tilordnet ved hjelp av "Effekt" menyen

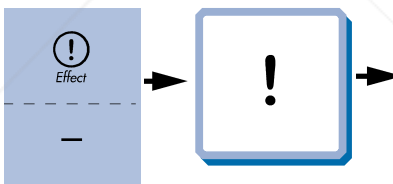
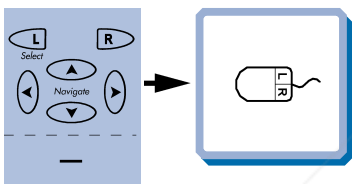

Press to zoom into picture (default setting)  
 Drücken, um Bild zu vergrößern (standardeinstellung)  
 Cliquez dans l'image pour faire un zoom (Paramètres par défaut)  
 Pulse para acercar la imagen (Configuración por defecto)  
 Premere per ingrandire l'immagine (impostazione di default)  
 Pressione para efetuar o "zoom" da imagem (Configuração predefinida)  
 Press for å forstørre bildet (standardinnstilling)

Press to pan  
 Drücken, um den Bildausschnitt zu wählen  
 Cliquez pour faire un panoramique  
 Pulse para panorámica  
 Premere per una panoramica  
 Pressione para "pan"  
 Press for å bevege bildet

Reset picture to full size  
 Zurück zur Originalgröße  
 Retour de l'image à ses dimensions  
 Restablecer la imagen a tamaño completo  
 Ripristino dell'immagine all dimensioni massime.  
 Reajuste a imagem a seu tamanho máximo.  
 Tilbakestill bildet til full størrelse

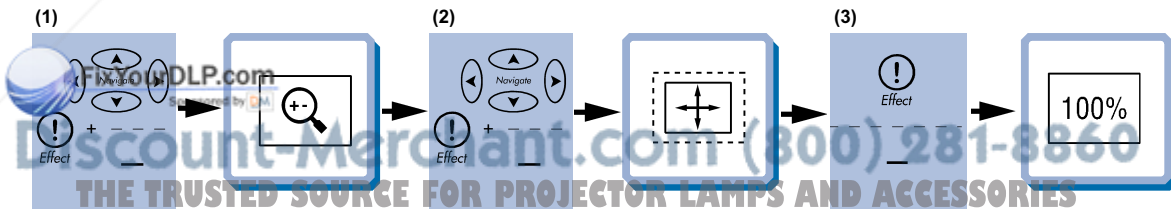

Activate/deactivate by:  
 Aktivieren/Deaktivieren mit:  
 Activer et désactiver à l'aide:  
 Activar/desactivar pulsando:  
 Attivare/disattivare premendo:  
 Ativa/Desativa com:  
 Aktiver/deaktiver med:

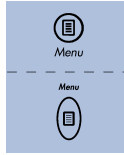

Navigate by:  
 Steuern mit:  
 Pour naviguer:  
 Navegar pulsando:  
 Spostasi premendo:  
 Navegar com:  
 Naviger med:

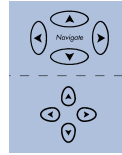

Choose function with:  
 Funktion wählen mit:  
 Choisissez la fonction avec:  
 Seleccionar función con:  
 Scegliere la funzione:  
 Escolha a função:  
 Velg funksjon med:

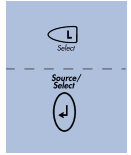

1.0

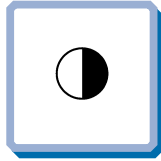
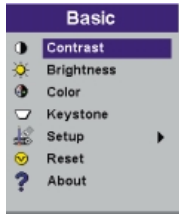

Adjusts contrast range from 0-100  
 Kontrast von 0-100 einstellen  
 Règle le contraste entre 0 et 100  
 Ajusta el contraste entre 0-100  
 Regolazione del contrasto da 0 a 100  
 Ajusta o contraste de 0 a 100  
 Justerer kontrasten innenfor området 0-100

4.0

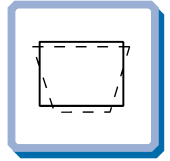
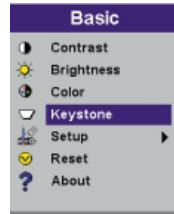

Adjust keystone from -63 to +64  
 Trapezentzerrung von -63 bis +64 einstellen  
 Règle la clé de voûte -63 et +64  
 Ajusta la distorsión de imagen desde -63 a +64  
 Regolazione della distorsione da -63 a +64  
 Ajusta o ângulo trapezoidal de -63 a +64  
 Justerer keystone-funksjonen fra -63 til +64

2.0



Adjusts brightness range from 0-100  
 Helligkeit von 0-100 einstellen  
 Règle la luminosité entre 0 et 100  
 Ajusta el brillo entre 0-100  
 Regolazione della luminosità da 0 a 100  
 Ajusta o brilho de 0 a 100  
 Justerer lysstyrken innenfor området 0-100

5.0

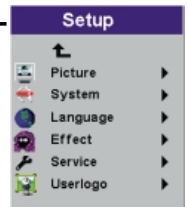
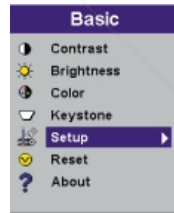

Adjusts brightness range from 0-100  
 Helligkeit von 0-100 einstellen  
 Règle la luminosité entre 0 et 100  
 Ajusta el brillo entre 0-100  
 Regolazione della luminosità da 0 a 100  
 Ajusta o brilho de 0 a 100  
 Justerer lysstyrken innenfor området 0-100

3.0

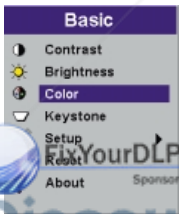

Adjusts colour intensity in video images from 0-100  
 Farbintensität von Videobildern von 0-100 einstellen  
 Règle l'intensité de la couleur des images vidéo entre 0 et 100  
 Ajusta la intensidad del color de la imagen vídeo entre 0-100  
 Regolazione dell'intensità del colore da 0 a 100 nelle immagini video  
 Ajusta a intensidade da cor em imagens de vídeo de 0 a 100  
 Justerer fargeintensiteten til videobilder fra 0-100

5.1

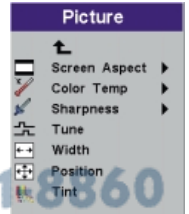
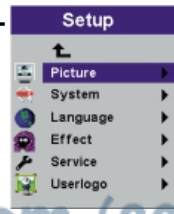

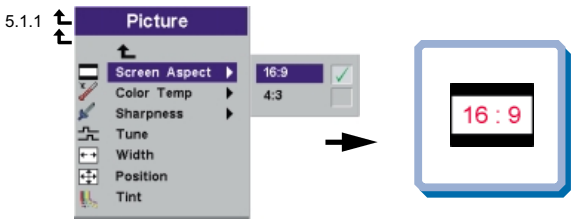

Select 16:9 widescreen image format  
[Auswahl Breitbildformat 16:9](#)  
 Sélectionner pour remettre toutes les options sur paramètres usine  
[Seleccionar el formato de imagen de pantalla ancha 16:9](#)  
 Selezione del formato panoramico 16:9  
[Seleciona o formato de imagem com largura de tela 16:9](#)  
 Velg vidvinkelformatet 16:9 for bildet

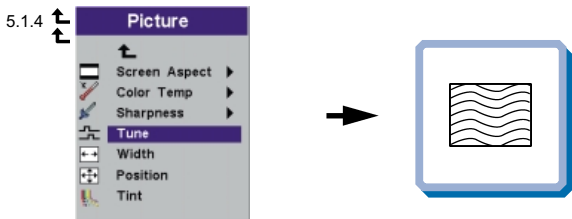

Adjusts horizontal phase/fine tunes computer analog image  
[Einstellung der Horizontalfrequenz/Feinabgleich für analoge Computerbilder](#)  
 Règle la phase horizontale/met au point l'image analogique de l'ordinateur  
[Ajusta la fase horizontal/sintoniza la imagen del ordenador analógico](#)  
 Regolazione della fase orizzontale/sintonizzazione fine dell'immagine analogica del computer  
[Ajusta as sintonias fase/fina horizontais da imagem analógica de computador](#)  
 Justerer den horisontale faser/finstiller datamaskinens analoge bilde

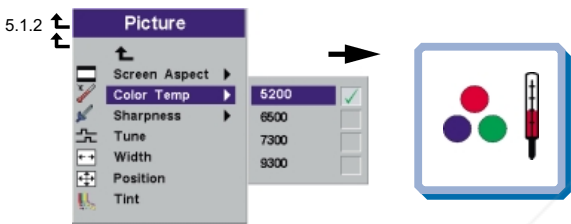

Modifies color temperature balance  
[Veränderung des Farbtemperaturwertes](#)  
 Modifie l'équilibre de la température couleur  
[Modifica el equilibrio de temperatura del color](#)  
 Modifica dell'equilibrio della temperatura di colore  
[Modifica o equilibrio da temperatura da cor](#)  
 Endrer balansen for fargetemperatur

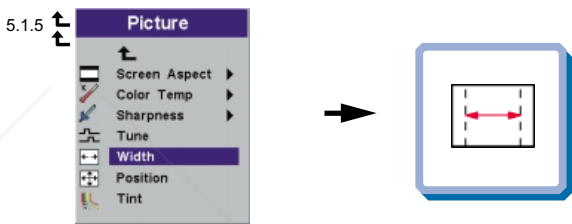

Adjusts width to computer analog image size  
[Anpassung der Breite auf Größe des analogen Computerbildes](#)  
 Règle la largeur à la dimension de l'image analogique de l'ordinateur  
[Ajusta el ancho al tamaño de la imagen del ordenador analógico](#)  
 Regolazione della larghezza alla dimensione dell'immagine analogica del computer  
[Ajusta a largura ao tamanho da imagem analógica de computador](#)  
 Justerer bredden på datamaskinens analoge bilde

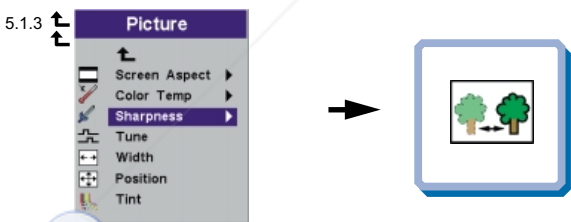

Adjusts sharpness in video images  
[Einstellung der Schärfe von Videobildern](#)  
 Règle la netteté des images vidéo  
[Ajusta la nitidez de la imagen de vídeo](#)  
 Regolazione della nitidezza dell'immagine video  
[Ajusta a nitidez nas imagens de vídeo](#)  
 Justerer skarpheten i videobilder.

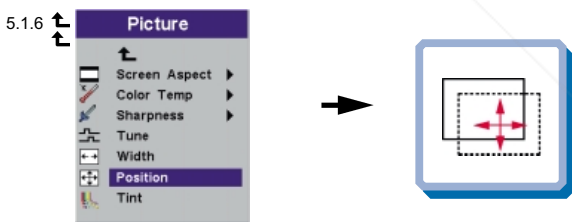

Adjusts position to computer analog and video image size  
[Anpassung der Position auf Größe Analog- und Videobildes](#)  
 Règle la position à la dimension de l'image analogique de l'ordinateur et de la vidéo.  
[Ajusta la posición al tamaño de la imagen del ordenador analógico y del vídeo](#)  
 Regolazione della posizione alle dimensioni dell'immagine analogica e video del computer  
[Ajusta a posição ao tamanho de imagem de computador analógica e de vídeo](#)  
 Justerer plasseringen på datamaskinens analoge bilde og videobilde

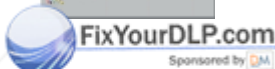

Direct-Merchant.com (800) 991-8860  
 SOURCE FOR PROJECTOR PARTS

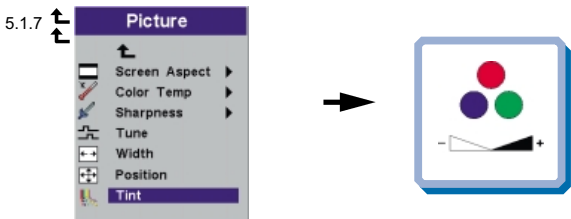

Varies the hue in video NTSC images from 0-100  
 Veränderung der Farbe von NTSC Videobildern von 0-100  
 Modifie le ton des images NTSC vidéo de 0 à 100  
 Varía la tonalidad de la imagen de vídeo NTSC entre 0-100  
 Variazione della tonalità cromaticada 0 a 100 nelle immagini video NTSC  
 Varia a tonalidade em imagens de vídeo NTSC de 0 a 100  
 Endrer fargenynansen til NTSC-videobilder innenfor området 0-100

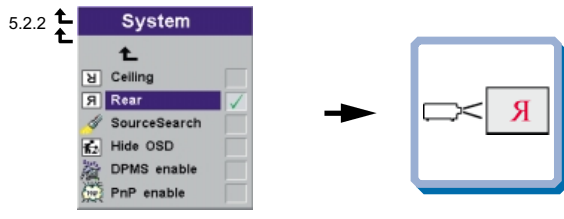

Select for rear projection  
 Markieren für Projektion von hinten  
 Sélectionner pour afficher l'information réparations  
 Seleccionar para proyección de transparencias  
 Selezione per la retroproiezione  
 Selezione para projeção de serviço automatizado  
 Velges hvis du vil bruke bakprosjeksjon

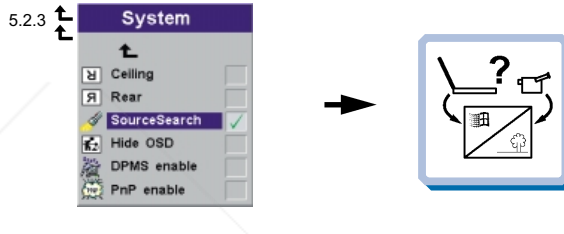
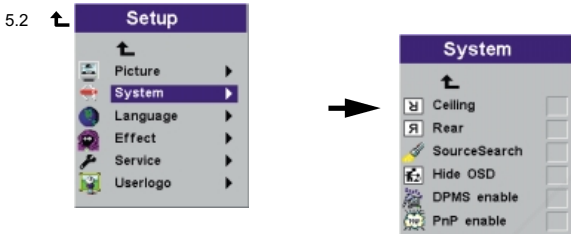

Select to activate / deactivate automatic source search  
 Entsprechend wählen, um automatische Quellensuche zu aktivieren  
 Sélectionnez "activer/désactiver" la recherche automatique de source  
 Seleccione para activar/desactivar la búsqueda automática del origen  
 Selezione per attivare/disattivare la ricerca della sorgente automatica  
 Selezione para ativar/desativar a busca automática  
 Velges om automatisk kildeøkning skal være aktiv/inaktiv

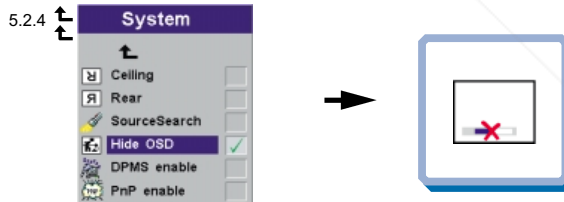
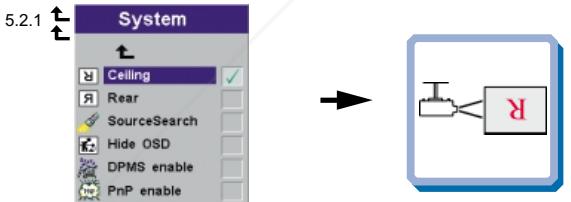

Select for ceiling mounted projection  
 Markieren für Projektion bei Deckenmontage  
 Sélectionner pour la projection appareil au plafond  
 Seleccionar para proyección montada en el techo  
 Selezione per la proiezione con montaggio al soffitto  
 Seleccione para projeção com montagem no teto  
 Velges hvis du vil bruke takmontert projeksjon

Select to hide On Screen Display (OSD)  
 Markieren, um Bildschirrmenu zu verbergen  
 Sélectionner pour effacer l'affichage sur l'écran  
 Seleccionar para ocultar la presentación en pantalla  
 Selezione per nascondere OSD  
 Selezione para ocultar a exibição na tela (OSD)  
 Velges hvis du vil slå av menyvisningen (OSD)

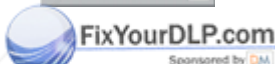

Discount-Merchant.com (800) 281-8860  
 THE BEST SOURCE FOR PROJECTOR PARTS AND ACCESSORIES



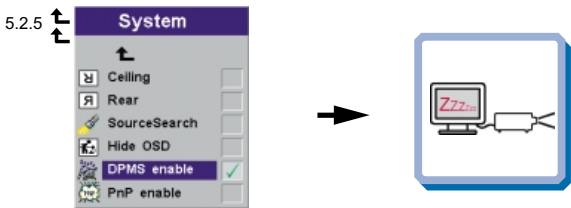

Select DPMS active/inactive. Ref. chapter J  
 DPMS aktivieren/deaktivieren. Siehe Kapitel J  
 Sélection DPMS actif/inactif. Voir chapitre J  
 Selecciona activar/desactivar DPMS. Consultar capítulo J  
 Selezione del DPMS attivo/inattivo. Vedere il capitolo J  
 Selezione DPMS ativo/inativo. Ref. capítulo J  
 Velg om DPMS-funksjonen skal være aktiv/inaktiv. Se kapittel J

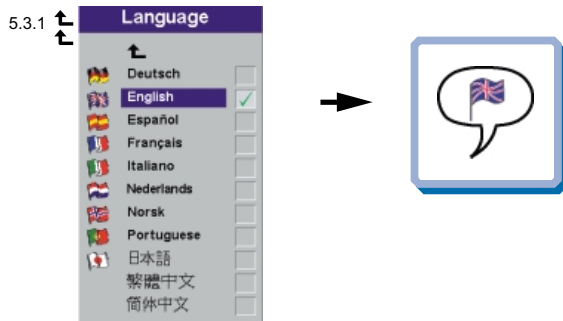

Select language  
 Sprache auswählen  
 Sélectionne la langue  
 Seleccionar lenguaje  
 Selezione della lingua  
 Selecciona o idioma  
 Velg språk

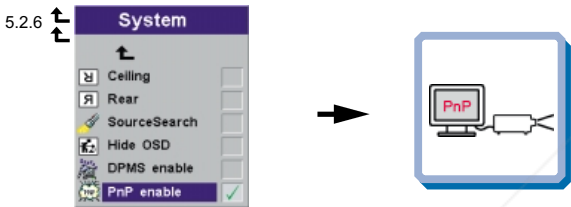

Select plug and play active/inactive  
 Plug and Play aktivieren/deaktivieren  
 Sélection "plug and play" actif/inactif  
 Selecciona activar/desactivar "plug & play" (enchufar y jugar)  
 Selezione del Plug & Play attivo/inattivo  
 Selezione plug and play ativo/inativo  
 Velg om plug and play skal være aktiv/inaktiv

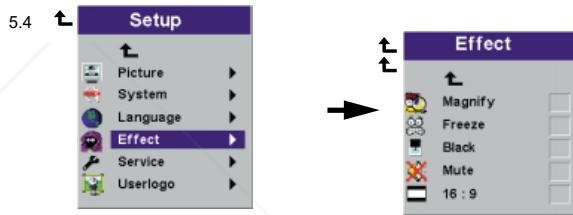

Tagged effect is assigned to the remote control's "Effect" key  
 Der eingestellte Effekt wird der "Effekt"-Taste an der Fernbedienung zugewiesen  
 L'effet annoté est assigné à la clé "Effet" contrôle à distance  
 El efecto de rótulos se asigna a la tecla "Efecto" del control remoto  
 L'effetto a tendina viene assegnato al tasto "Effetto" sul telecomando  
 O efeito Tagged é designado à tecla "Efeito" do controle remoto  
 Den avmerkede effekten tilordnes "Effect"-tasten på fjernkontrollen

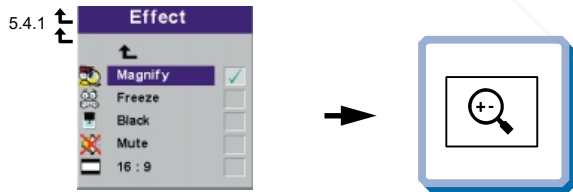
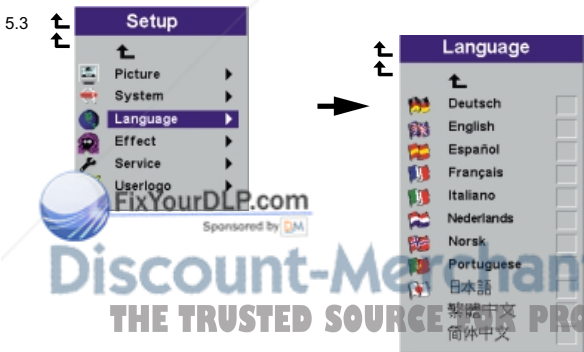

Assigns the "Effect" key's function to "magnify" (default setting)  
 Der "Effekt"-Taste wird als Funktion "Vergrößern" zugewiesen (StandardEinstellung)  
 Assigne la fonction de la clé "Effet" à "agrandir" (paramètres par défaut)  
 Configure la función "amplificar" en la tecla "Efecto" (configuración por defecto)  
 Assegna la funzione del tasto "Effetto" a "ingrandire" (impostazione di default)  
 Designa a função da tecla "Efeito" para "ampliar" (configuração predefinida)  
 Setter "Effect"-tastens virkemåte til "zoom" (standardinnstilling)

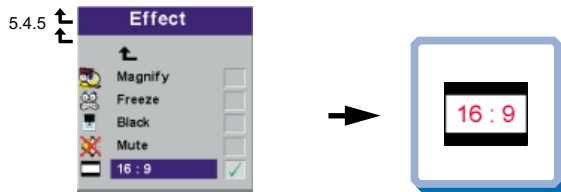
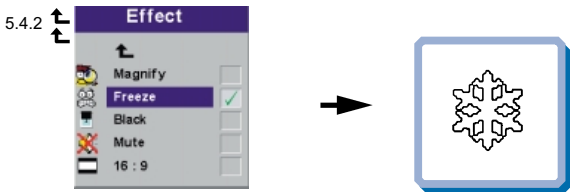

Assigns the "Effect" key's function to "freeze the projected image"  
 Der "Effekt"-Taste wird als Funktion "Projiziertes Bild einfrieren" zugewiesen  
 Assigne la fonction de la clé "Effet" à "arrêter sur image projetée"  
 Configure la función "congelar la imagen proyectada" en la tecla "Efecto"  
 Assegna la funzione del tasto "Effetto" a "fermo immagine"  
 Designa a função da tecla "Efeito" para "congelar a imagem projetada"  
 Setter "Effect"-tastens virkemåte til "frys det projiserte bildet"

Assigns the "Effect" key's function to "16:9 wide screen image format"  
 Der "Effekt" - Taste wird als Funktion "Breitbildformat 16:9" zugewiesen  
 Assigne la touche de fonction "Effets" à la "grande image sur écran 16:9"  
 Establezca la función de la tecla "Efecto" en el "formato de pantalla ancha 16:9"  
 Assegnare la funzione della tastiera "Effetto" al "formato panoramico 16:9"  
 Atribui a função da tecla de efeito ao "formato de imagem de tela ampla 16:9"  
 Setter "Effect"-tastens virkemåte til "vidvinkelformatet 16.9 for bildet"

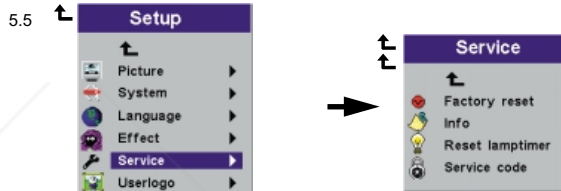
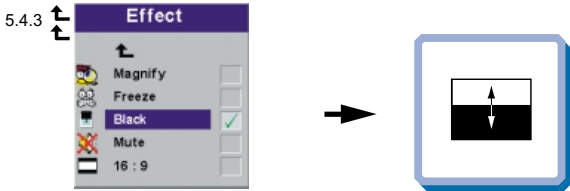

Assigns the "Effect" key's function to "Mask the projected image"  
 Der "Effekt"-Taste wird als Funktion "Projiziertes Bild verbergen" zugewiesen  
 Assigne la fonction de la clé "Effet" à "masquer l'image projetée"  
 Configure la función "ocultar la imagen proyectada" en la tecla "Efecto"  
 Assegna la funzione del tasto "Effetto" a "maschera dell'immagine proiettata"  
 Designa a função da tecla "Efeito" para "mascarar a imagem projetada"  
 Setter "Effect"-tastens virkemåte til "legg maske på det projiserte bildet"

Assigns the "Service" key's function to "Factory reset"  
 Der "Service"-Taste wird als Funktion "Werkseinstellung zurücksetzen" zugewiesen  
 Assigne la touche de fonction "Service" à "réinitialiser les paramètres usine"  
 Configure la función "restaurar a configuración original" en la tecla "Servicio"  
 Assegna la funzione del tasto "Servizio" a "ripristino di fabbrica"  
 Designa a função da tecla "Serviço" para "colocar ao som em modo"  
 Setter "Service"-tastens virkemåte til "tilbakestill fabrikkinnstillingene"

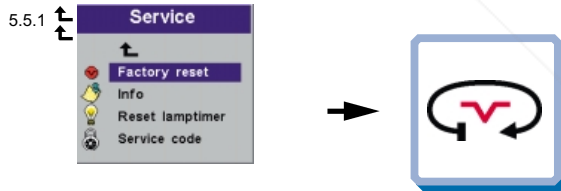
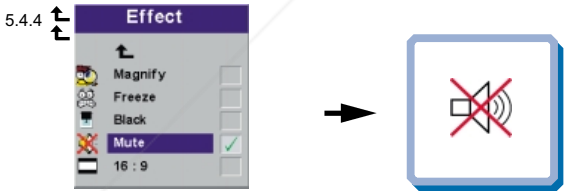

Assigns the "Effect" key's function to "mute the sound"  
 Der "Effekt"-Taste wird als Funktion "Ton abstellen" zugewiesen  
 Assigne la fonction de la clé "Effet" à "mettre la sourdine"  
 Configure la función "silenciar el sonido" en la tecla "Efecto"  
 Assegna la funzione del tasto "Effetto" a "disattivazione audio"  
 Designa a função da tecla "Efeito" para "colocar o som em modo"  
 Setter "Effect"-tastens virkemåte til "mute" (dvs. at lyden slås av)

Select to reset all options to factory settings  
 Aktivieren, um alle Optionen auf Werkseinstellung zu setzen  
 Sélectionner pour remettre toutes les options sur paramètres usine  
 Seleccionar para restablecer todas las opciones a la configuración original  
 Selezione per il ripristino di tutte le opzioni sulle impostazioni di fabbrica  
 Seleção para que as opções retornem à programação inicial de fábrica  
 Velges hvis du vil tilbake stille alle innstillinger til fabrikkinnstillingene



Discount-Merchant.com (800) 281-8860

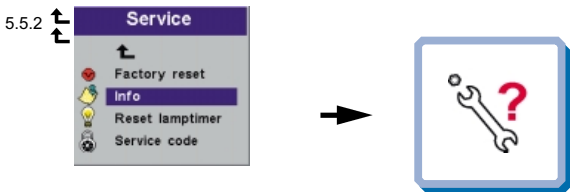

Select to display service information  
 Aktivieren, um Serviceinformationen anzuzeigen  
 Sélectionner pour afficher l'information réparations  
 Sólo para personal técnico  
 Selezione per visualizzare le informazioni sull'assistenza  
 Seleção para obter informação sobre a fonte selecionada  
 Velges hvis du vil vise serviceinformasjon

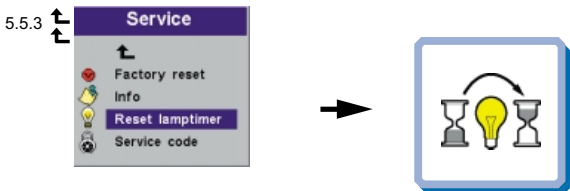
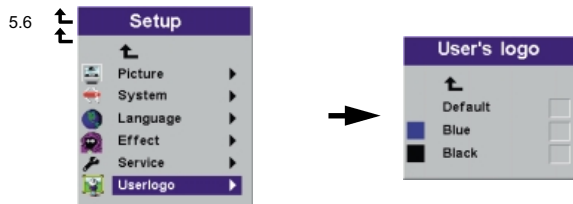

Select to reset lamp timer after lamp replacement  
 Aktivieren, um Lampenstundenzähler nach dem Austausch auf Null zu setzen  
 Sélectionner pour remettre l'horloge de la lampe à zéro après changement de lampe  
 Seleccionar para restablecer el temporizador de la bombilla tras la sustitución de la misma  
 Selezione per ripristinare il temporizzatore della lampadina dopo la sua sostituzione  
 Seleção para zerar o cronómetro da lâmpada após substituição da mesma  
 Velges for å tilbakestille telleverket for lampen etter lampeskift



Projects the default projector logo screen when no source is connected  
 Es wird die standardgemäß eingestellte Logo-Anzeige des Projektors gezeigt, wenn keine Quelle angeschlossen ist  
 Projette par défaut l'écran logo lorsque aucune source n'est branchée  
 Cuando no hay ninguna fuente conectada, se proyecta la pantalla por defecto con el logotipo del proyector  
 Proietta lo schermo con il logo predefinito del proiettore quando non ci sono sorgenti collegate  
 Projeta tela predefinida do logotipo do projetor quando nenhuma fonte está conectada  
 Projiserer standard logoskjembilde for projektoren når ingen kilde er tilkoblet.

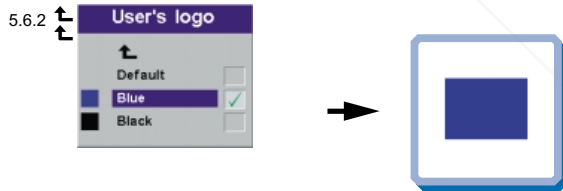
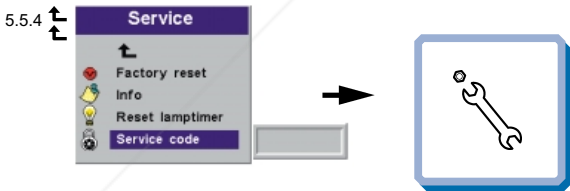

Projects a blue screen when no source is connected  
 Wenn keine Quelle angeschlossen ist, wird eine blaue Anzeige projiziert  
 Projette un écran bleu lorsque aucune source n'est branchée  
 Cuando no hay ninguna fuente conectada, se proyecta una pantalla azul  
 Proietta uno schermo blu quando non ci sono sorgenti collegate  
 Projeta uma tela azul quando nenhuma fonte está conectada  
 Projiserer et blått skjembilde når det ikke er tilkopleet noen kilde



Only for service personnel  
 Nur für Kundendienstpersonal  
 Pour le personnel technique uniquement  
 Sólo para personal técnico  
 Ad uso esclusivo dei tecnici di assistenza  
 Somente para serviço autorizado  
 Bare for servicepersonell

Discount-Merchant.com (800) 281-8860  
 THE TRUSTED SOURCE FOR PROJECTOR PARTS AND ACCESSORIES

5.6.3

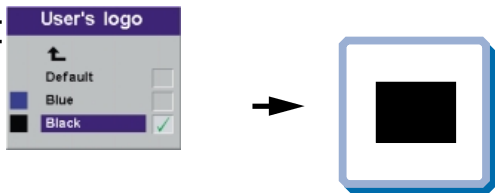

Projects a black screen when no source is connected  
 Wenn keine Quelle angeschlossen ist, wird eine schwarze Anzeige projiziert  
 Projette un écran noir lorsque aucune source n'est branchée  
 Cuando no hay ninguna fuente conecta, se proyecta una pantalla negra  
 Proietta uno schermo nero quando non ci sono sorgenti collegate  
 Projeta uma tela preta quando nenhuma fonte está conectada  
 Projiserer et svart skjerm bilde når det ikke er tilkoblet noen kilde

6.0

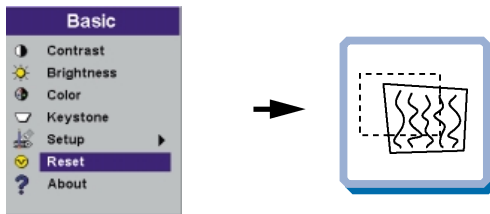

Synchronizes the projector settings to the active source  
 Synchronisiert die Projektoreinstellungen für die aktive Quelle  
 Synchronise les paramètres du projecteur avec la source active  
 Sincroniza las configuraciones del proyector con la fuente activa  
 Sincronizza le impostazioni del proiettore sulla sorgente attiva  
 Sincroniza a configuração do projetor com a fonte ativa  
 Synkroniserer projektorens innstillinger med den aktive kilden



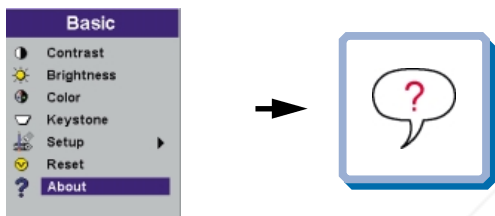

7.0







Indicates information about selected source  
 Zeigt Information über die aktive Quelle an  
 Renseigne sur la source sélectionnée  
 Proporciona información sobre fuentes seleccionadas  
 Informazioni sulla sorgente selezionata  
 Fornece informação sobre a fonte selecionada  
 Viser informasjon om den valgte kilden



**Discount-Merchant.com (800) 281-8860**  
**THE TRUSTED SOURCE FOR PROJECTOR LAMPS AND ACCESSORIES**

| <b>CONDITION</b><br><b>LEUCHTANZEIGE</b><br><b>ETAT</b><br><b>INDICACIÓN</b><br><b>CONDIZIONE</b><br><b>CONDICÃO</b><br><b>TILSTAND</b>   | <b>STATUS</b><br><b>ZUSTAND</b><br><b>STATUT</b><br><b>ESTADO</b><br><b>STATO</b><br><b>STATUS</b><br><b>STATUS</b>  | <b>EXPLANATION</b><br><b>ERLÄUTERUNG</b><br><b>EXPLICATION</b><br><b>EXPLICACIÓN</b><br><b>SPIEGAZIONE</b><br><b>EXPLICAÇÃO</b><br><b>FORKLARING</b>   |
|---|--|--|
| <p>Green<br/>Grün<br/>Vert<br/>Luz verde<br/>Verde<br/>Verde<br/>Grønt</p>  <p>Power<br/>Alarm</p>   | <p>Power ON (picture on the screen)<br/>EIN (Bild auf Leinwand)<br/>Position ON (image sur l'écran)<br/>Encendido (ON) (imagen en pantalla)<br/>Acceso (immagine sullo schermo)<br/>Ligado (imagem na tela)<br/>Strøm PÅ (bilde på skjermen)</p>   | <p>Normal mode.<br/>Betriebsmodus<br/>Mode normal<br/>Modo normal<br/>Modalità normale<br/>Modo normal<br/>Normal modus.</p>   |
| <p>Slow orange blinking.<br/>Orange (langsam blinkend).<br/>Orange pâle clignotant.<br/>Luz naranja parpadeando lentamente.<br/>Lampeggio arancione lento<br/>Laranja piscando lentamente<br/>Oransje, langsomt blinkende.</p>  <p>Power<br/>Alarm</p> | <p>Power OFF has been selected and OSD logo screen is displayed.<br/>Der Projektor wurde auf AUS gestellt, das OSD-Logo wird angezeigt.<br/>La position OFF a été sélectionnée et l'écran logo OSD est affiché<br/>Se ha seleccionado APAGADO y la (OFF) pantalla muestra el logotipo de OSD.<br/>É stato selezionato lo spegnimento OFF e viene proiettato sullo schermo il logo OSD<br/>A opção DESLIGAR foi selecionada e a tela do logotipo OSD é exibida.<br/>Strøm AV er valgt, og logoskjærmbildet for OSD vises.</p> | <p>The projector is going to standby.<br/>Projektor geht in Standby-Modus über<br/>Le projecteur passe en standby (attente)<br/>El projector se coloca en stndby<br/>Il proiettore sta entrando in stand-by<br/>O projetar está entrando em standby<br/>Projektoren går til ventemodus</p>   |
| <p>Orange<br/>Orange<br/>Orange<br/>Luz naranja<br/>Arancione<br/>Laranja<br/>Oransje</p>  <p>Power<br/>Alarm</p>  | <p>Standby mode<br/>Standby-Modus<br/>Mode standby (attente)<br/>Modo standby<br/>Modalità stand-by<br/>Modo standby<br/>Ventemodus</p>  | <p>The projector is in standby (sleep) mode.<br/>Der Projektor befindet sich in Standby-Modus<br/>Le projecteur est en mode standby (attente)<br/>El projector está en modo standby (sleep)<br/>Il proiettore è in modalità stand-by (sleep)<br/>O projetar está em modo standby (descanso)<br/>Projektoren er i ventemodus (dvalemodus)</p>   |
| <p>Red<br/>Rot<br/>Rouge<br/>Luz roja<br/>Rosso<br/>Armelho<br/>Rødt</p>  <p>Power<br/>Alarm</p>   | <p>Lamp life has expired, OSD message is displayed.<br/>Lampenwechsel ist fällig, OSD-Meldung erscheint.<br/>La durée de vie de la lampe est dépassée, un message OSD est affiché.<br/>Aparece un mensaje de OSD indicando que la bombilla se ha agotado.<br/>La vita utile della lampadina è giunta a termine, viene proiettato il messaggio OSD.<br/>A vida útil da lâmpada expirou, uma mensagem OSD é exibida.<br/>Lampens levetid er overskredet, OSD-melding vises.</p>  | <p>The lamp lifetime is overdue. Return the projector to qualified service personnel for lamp change.<br/>Die Lebensdauer der Lampe ist abgelaufen. Lassen Sie einen Lampenwechsel vonqualifiziertem Kundendienstpersonal durchführen.<br/>La durée de vie de la lampe est dépassée. Retournez le projecteur au personnel technique qualifié pour le changement de lampe.<br/>La vida útil de la bombilla se ha agotado. Lleve el proyector a un servicio técnico autorizado para cambiarla.<br/>È stata superata la durata della lampadina. Rendere il proiettore a tecnici di assistenza qualificati per la sostituzione della lampadina.<br/>A vida útil da lâmpada está ultrapassada. Leve o projetor a um serviço de assistência qualificado para troca de lâmpada.<br/>Lampens levetid er overskredet. Send projektoren til kvalifisert servicepersonell for lampeskift.</p> |

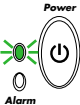
| <b>CONDITION</b><br><b>LEUCHTANZEIGE</b><br><b>ETAT</b><br><b>INDICACIÓN</b><br><b>CONDIZIONE</b><br><b>CONDICÃO</b><br><b>TILSTAND</b>   | <b>STATUS</b><br><b>ZUSTAND</b><br><b>STATUT</b><br><b>ESTADO</b><br><b>STATO</b><br><b>STATUS</b><br><b>STATUS</b>   | <b>EXPLANATION</b><br><b>ERLÄUTERUNG</b><br><b>EXPLICATION</b><br><b>EXPLICACIÓN</b><br><b>SPIEGAZIONE</b><br><b>EXPLICACÃO</b><br><b>FORKLARING</b>  |
|---|---|---|
| <p>Fast red blinking<br/> <b>Rot (schnell blinkend)</b><br/>                     Rouge à clignotement rapide<br/>                     Luz roja parpadeando rápidamente<br/>                     Lampeggio rosso rapido<br/>                     Vermelho piscando rapidamente<br/>                     Rødt, raskt blinkende</p>    | <p>High temperature, OSD message is displayed.<br/>                     Überhitzung,<br/>                     OSD-Meldung wird angezeigt.<br/>                     Température élevée,<br/>                     Un message OSD est affiché<br/>                     Aparece un mensaje de OSD que indica temperatura elevada.<br/>                     Temperatura elevata, viene proiettato il messaggio OSD.<br/>                     Temperatura alta. Uma mensagem OSD é exibida.<br/>                     OSD-melding om høy temperatur vises.</p> | <p>The projector temperature is above the critical limit. Please allow the projector to cool down by turning off the projector.<br/>                     Die Temperatur des Projektors befindet sich im kritischen Bereich. Schalten Sie den Projektor aus und lassen ihn abkühlen.<br/>                     La température du projecteur est trop élevée. Eteignez le projecteur et laissez-le refroidir.<br/>                     La temperatura del proyector ha alcanzado el punto crítico. Apague el proyector y deje que se enfríe.<br/>                     La temperatura del proiettore ha superato il limite critico. Spegner il proiettore e lasciarlo raffreddare<br/>                     A temperatura do projetor está acima do limite crítico. Por favor permita que o projetor esfrie desligando-o.<br/>                     Projektorens temperatur er over den kritiske grensen. slå projektoren av slik at den kan kjøle seg ned.</p> |
| <p>Red blinking (** - ** - **)<br/> <b>Rot blinkend (** - ** - **)</b><br/>                     Rouge à clignomente (** - ** - **)<br/>                     Luz roja parpadeando (** - ** - **)<br/>                     Lampeggio rosso (** - ** - **)<br/>                     Vermelho piscando (** - ** - **)<br/>                     Rødt blinkende (** - ** - **)</p>  | <p>Projector will shut down<br/>                     Der Projektor wird heruntergefahren<br/>                     Le projecteur s'éteindra<br/>                     El proyector se apagará<br/>                     Il proiettore si spegne<br/>                     O projetor apagará<br/>                     Prosjektoren vil slå seg av</p>   | <p>The fans are not connected / operating<br/>                     Die Ventilatoren sind nicht angeschlossen/in Betrieb<br/>                     Le ventilateur n'est pas branché/ne fonctionne pas<br/>                     Los ventiladores no están conectados o funcionando<br/>                     Le ventole non sono collegate/operative<br/>                     Os ventiladores não estão conectados/funcionando<br/>                     Viftene er ikke tilkoblet/i gang</p>  |

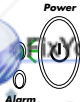
| <b>CONDITION</b><br><b>LEUCHTANZEIGE</b><br><b>ETAT</b><br><b>INDICACIÓN</b><br><b>CONDIZIONE</b><br><b>CONDICÃO</b><br><b>TILSTAND</b>   | <b>STATUS</b><br><b>ZUSTAND</b><br><b>STATUT</b><br><b>ESTADO</b><br><b>STATO</b><br><b>STATUS</b><br><b>STATUS</b>  | <b>EXPLANATION</b><br><b>ERLÄUTERUNG</b><br><b>EXPLICATION</b><br><b>EXPLICACIÓN</b><br><b>SPIEGAZIONE</b><br><b>EXPLICACÃO</b><br><b>FORKLARING</b>  |
|---|--|---|
| <p>Slow green blinking<br/> Grün (langsam blinkend)<br/> Vert à clignotement lent<br/> Luz verde parpadeando lentamente<br/> Lampeggio verde lento<br/> Verde piscando lentamente<br/> Grønt, langsomt blinkende</p>    | <p>DPMS Mode (black screen)<br/> DPMS-Modus (schwarze Leinwand)<br/> Mode DPMS (écran noir)<br/> Modo DPMS (pantalla en negro)<br/> Modalità DPMS (schermo nero)<br/> Modo DPMS (Tela preta)<br/> DPMS-modus (svart skjerm)</p>                                    | <p>No valid source detected<br/> Keine zulässige Quelle gefunden<br/> Aucune source adéquate détectée<br/> No se ha detectado ninguna fuente válida<br/> Non viene rilevata nessuna sorgente<br/> Nenhuma fonte válida foi detectada<br/> Ingen gyldig kilde funnet</p>   |
| <p>Slow green blinking<br/> Grün (langsam blinkend)<br/> Vert à clignotement lent<br/> Luz verde parpadeando lentamente<br/> Lampeggio verde lento<br/> Verde piscando lentamente<br/> Grønt, langsomt blinkende</p>    | <p>DPMS Mode (Lamp is off)<br/> DPMS-Modus (Lampe ist aus)<br/> Mode DPMS (La lampe est éteinte)<br/> Modo DPMS (la bombilla está apagada)<br/> Modalità DPMS (la lampadina è spenta)<br/> Modo DPMS (a lâmpada está desligada)<br/> DPMS-modus (lampen er av)</p> | <p>No valid source detected in the last 3 minutes. The projector will stay in this mode for 5 minutes. If you get a valid source within 5 minutes, the projector will turn on again.<br/> Nach Ablauf von 3 Minuten keine zulässige Quelle gefunden. Der Projektor bleibt 5 Minuten lang in diesem Zustand. Wenn Sie in dieser Zeit eine zulässige Quelle anschließen, schaltet sich der Projektor wieder ein.<br/> Aucune source adéquate détectée au cours des 3 dernières minutes. La projecteur restera sur ce mode pensant 5 minutes. Si vous lui fournissez une source adéquate dans les 5 minutes, il s'allumera de nouveau.<br/> Han transcurrido 3 minutos sin detectar ninguna fuente válida. El proyector permanecerá en este modo durante 5 minutos. Si dentro de ese plazo se le proporciona una fuente válida, volverá a ponerse en marcha.<br/> Non è stata rilevata nessuna sorgente valida negli ultimi tre minuti. Il proiettore rimarrà in questa modalità per 5 minuti. Se si trova una sorgente valida entro 5 minuti, il proiettore tornerà ad accendersi.<br/> Nenhuma fonte válida foi detectada nos últimos 3 minutos. O projetor permanecerá neste modo por 5 minutos. O projetor ligará novamente se obtiver uma fonte válida dentro de 5 minutos.<br/> Ingen gyldig kilde funnet i løpet av de siste 3 minuttene. Projektoren holder seg i denne modusen i 5 minutter. Hvis det blir funnet en gyldig kilde i løpet av 5 minutter, slår projektoren seg på igjen.</p> |
| <p>Slow green blinking<br/> Grün (langsam blinkend)<br/> Vert à clignotement lent<br/> Luz verde parpadeando lentamente<br/> Lampeggio verde lento<br/> Verde piscando lentamente<br/> Grønt, langsomt blinkende</p>  | <p>OSD logo screen is displayed<br/> OSD-Logo wird angezeigt<br/> L'écran logo OSD est affiché<br/> La pantalla muestra el logotipo de OSD<br/> Viene proiettato il logo OSD<br/> A tela do logotipo OSD é exibida<br/> Logoskjermbildet for OSD vises</p>         | <p>The projector will search until a valid source is detected<br/> Der projektor versucht eine zulässige Quelle zu finden<br/> Le projecteur cherchera jusqu'à détecter une source adéquate<br/> El proyector buscará hasta detectar una fuente válida<br/> Il proiettore cercherà fino a trovare una sorgente valida<br/> O projetor procurará até detectar uma fonte válida<br/> Projektoren vil søke til en gyldig kilde blir funnet</p>   |



**Discount-Merchant.com (800) 281-8860**  
**THE TRUSTED SOURCE FOR PROJECTOR LAMPS AND ACCESSORIES**



**No image on the screen**  
**Kein Bild auf der Leinwand**  
**Pas d'image sur l'écran**  
**Sin imagen en pantalla**  
**Assenza di immagine sullo schermo**  
**Não há imagem na tela**  
**Skjermen viser ikke bilde**

- Verify the power connections to the projector (check that the power light is on)  
**Stromanschluss des Projektors überprüfen (Power-Leuchtanzeige muss leuchten)**  
**Vérifiez les connexions de l'alimentation au projecteur (vérifiez que l'indicateur d'alimentation est allumé)**  
**Verifique las conexiones del proyector (compruebe que la luz de energía está encendida)**  
**Verificare la connessione dell'alimentazione del proiettore (controllare che la spia dell'alimentazione sia accesa)**  
**Verifique as conexões de alimentação elétrica do projetor (veja se a luz que indica o estado de ligado está acesa)**  
**Kontroller strømtilkoblingen for projektoren (sjekk at lyset for strøm er på)**
- Verify the settings on your laptop  
**Einstellungen am Laptop überprüfen**  
**Vérifiez les paramètres sur votre portable**  
**Verifique las configuraciones de su ordenador**  
**Verificare le impostazioni del computer**  
**Verifique as configurações no seu laptop**  
**Kontroller innstillingene på den bærbare datamaskinen**
- Verify that the black-button is not activated on the remote  
**Prüfen, dass "Black" (Verdunkeln) an der Fernbedienung nicht aktiviert ist**  
**Vérifiez que le bouton noir n'est pas activé sur la télécommande**  
**Verifique que el botón negro no esté activado para control remoto**  
**Verificare che il pulsante nero sul telecomando non sia attivato**  
**Assegure-se de que botão preto não esteja ativado no controle remoto**  
**Kontroller at Black-knappen på fjernkontrollen ikke er aktivert**
- Check if lens cap is mounted  
**Sicherstellen, dass die Linseabdeckung abgenommen ist**  
**Assurez-vous que la protection de la lentille n'est pas posée**  
**Compruebe que la tapa de la lente está montada**  
**Controllare che non sia montato il coperchio della lente**  
**Verifique se o protetor de lente está colocado**  
**Kontroller om linsedekselet er på**



**The projected image is not focused**  
**Das projizierte Bild ist nicht scharf**  
**L'image projetée n'est pas au point**  
**La imagen proyectada no está enfocada**  
**L'immagine proiettata non è a fuoco**  
**A imagem projetada está fora de foco**  
**Bildet som projiseres er ikke i fokus**

- Ensure that the distance from the projector to the screen is at least at the minimum specified  
**Überprüfen, ob der Abstand zwischen Projektor und Leinwand groß genug ist**  
**Vérifiez que la distance minimum indiquée entre le projecteur et l'écran est respectée**  
**Asegurese de que la distancia desde el proyector a la pantalla**  
**Assicurarsi che la distanza dal proiettore allo schermo non sia inferiore al minimo di specifica**  
**Certifique-se de que a distância entre o projetor e a tela esteja pelo menos no mínimo especificado**  
**Kontroller at avstanden fra projektoren til skjermen er minst angitt minimum**
- Adjust the focus ring on the projection lens  
**Fokusing an der Linse verstellen**  
**Réglez la bague de mise au point sur la lentille de projection**  
**Ajuste el aro de enfoque de la lente de proyección**  
**Regolare l'anello di messa a fuoco sulla lente di proiezione**  
**Ajuste o anel de foco a lente de projeção**  
**Vri på fokuseringsringen på projekjonslinsen**
- Ensure that the projection lens is clean  
**Prüfen, ob Linse sauber ist**  
**Vérifiez que la lentille de projection est propre**  
**Asegurese de que la lente de proyección está limpia**  
**Assicurarsi che la lente di proiezione sia pulita**  
**Assegure-se de que a lente de projeção**  
**Kontroller at projekjonslinsen er ren**
- Verify that the projector is correctly aligned with the projected screen  
**Prüfen, ob der Projektor richtig zur Leinwand ausgerichtet ist**  
**Vérifiez que le projecteur est correctement aligné avec l'écran**  
**Verifique que el proyector está correctamente alineado con la pantalla proyectada**  
**Verificare che il proiettore sia allineato correttamente con lo schermo**  
**Verifique se o projetor está corretamente alinhado com a tela de projeção**  
**Kontroller at projektoren er korrekt plassert i forhold til skjermen det projiseres**
- In Video: Check the sharpness setting in the "Set up/Picture" menu and adjust if necessary  
**Bei Video: Schärfefeinstellung im Menü "Set up/Picture" prüfen und bei Bedarf ändern**  
**Source Vidéo: Vérifiez le réglage de netteté de l'image dans le menu "Set up/Picture" et réglez si besoin est**  
**En vídeo: compruebe la configuración de la nitidez en el menú "Set up/Picture" ajústelo si fuera necesario**  
**In Video: Controllare la regolazione della nitidezza nel menu "Set up/Picture e regolarla se necessario**  
**No video: verifique a configuração da nitidez no menu "Set up/Picture" ajuste a se necessário**  
**I video-modus: Kontroller innstillingen for skarphet på menyen "Set up/Picture", og tilpass den om nødvendig**



**No sound**  
**Kein Ton**  
**Pas de son**  
**Sin soeno**  
**Nessun suono**  
**Não há som**  
**Ingen lyd**

- Check the audio input connections  
**Verbindung am Audioeingang überprüfen**  
**Vérifiez les connexions entrée audio**  
**Compruebe las conexiones de entrada de audio**  
**Controllare i collegamenti di ingresso audio**  
**Verifique as conexões de entrada de áudio**  
**Kontroller tilkoblingene for lydinnngangene**
- Adjust the volume  
**Lautstärke verstellen**  
**Réglez le volume**  
**Ajuste el volumen**  
**Regolare il volume**  
**Ajuste o volume**  
**Juster lydstyrken**
- Verify that the audio cable is OK  
**Prüfen, ob Audiokabel in Ordnung ist**  
**Vérifiez que le câble audio n'est pas endommagé**  
**Verifique que el cable de audio está bien**  
**Verificare che il cavo audio sia a posto**  
**Verifique se o cabo de áudio está conforme**  
**Kontroller at lyd-kablen er OK**
- Adjust the audio source  
**Einstellungen an der Audioquelle vornehmen**  
**Réglez la source audio**  
**Ajuste la fuente de audio**  
**Regolare la sorgente audio**  
**Ajuste a fonte de áudio**  
**Juster lyd-kilden**



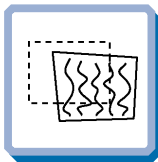

**The projected image is distorted**  
**Das projizierte Bild ist verzerrt**  
**L'imagen projectada est d'orsionada**  
**L'immagine proiettata è distorta**  
**A imagem projetada está distorcida**  
**Bildet som vises er forvrengt**

2. Select Menu on remote or on projector  
**Menü über Fernbedienung oder Bedienfeld wählen**  
 Sélectionnez Menu sur la télécommande ou sur le projecteur  
**Selecciona el Menú por control remoto o en el proyector**  
 Selezionare Menü sul telecomando o sul proiettore  
 Seleccione o Menu no controle remoto ou no projetor  
 Trykk på Menu på fjernkontrollen eller projektoren



1. Press the Power button and go to Reset  
**Auf Power drücken und Reset durchführen**  
 Appuyez sur le bouton "Power" et Remettez à zéro  
**Pulse el botón Power y vaya a Reset (restablecer)**  
 Premere il tasto Power e iniziare il Ripristino (reset)  
**Desligue e ligue novamente o projetor pressionando o botão LIG/DES LIG**  
 Trykk på Power-knappen og gå til Reset



Select "Picture"  
**"Picture" wählen**  
 Sélectionnez "Picture"  
**Selecione "Picture"**  
 Selezionare "Picture"  
 Seleccione "Picture"  
 Velg "Picture"



Go to "Set up"  
**Zu "Set up" gehen**  
 Choisissez "Set up"  
**Vaya a "Set up"**  
 Portarsi su "Set up"  
**Vá ao menu "Set up"**  
 Gå til "Set up"

Select Frequency or Tuning for image manual adjustments  
**Frequenz oder Tuning für manuelle Bildeinstellung wählen**  
 Sélectionnez Frequency ou Tuning pour le réglage manuel de l'image  
**Selecione Frequency o Tuning para ajustar manualmente la imagen**  
 Selezionare Frequency o Tuning per la regolazione manuale dell'immagine  
 Seleccione Freqüência ou Sintonia para ajustes manuais da imagem  
 Velg Frequency eller Tuning for å justere bildet manuelt

3. Verify that the projector is not tilted/elevated and that it is parallel with the projected screen  
**Sicherstellen, dass der Projektor nicht schief oder zu hoch steht und dass er parallel zur Leinwand ausgerichtet ist**  
 Vérifiez que le projecteur n'est pas incliné/surélévée et qu'il est parallèle à l'écran de projection  
**Verifique que el proyector no está inclinado/elevado y que está en paralelo con la imagen proyectada**  
 Verificare che il proiettore non sia inclinato/elevato e che sia parallelo allo schermo di proiezione  
**Verifique se o projetor não está inclinado/elevado e se está paralelo à tela projetada**  
 Kontroller at projektoren ikke er vippt opp- eller nedover eller hevet, og at den er parallell med skjermen det projiseres

4. Check if the digital keystone function is active. Adjust if necessary  
**Prüfen, ob Trapezverzerrung aktiv ist. Falls nötig, einstellen**  
 Regardez si la fonction keystone digitale est active. Réglez si besoin est  
**Compruebe si la función de distorsión digital está activada. Ajústela si fuera necesario**  
 Controllare che sia attiva la funzione di distorsione digitale. Regolarla se necessario  
**Veja se a função digital do ângulo trapezoidal está ativa. Ajuste se necessário**  
 Kontroller om den digitale keystone-funksjonen er aktiv. Juster den om nødvendig

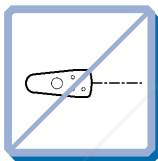

**Projector does not respond to remote control**  
**Die Fernbedienung funktioniert nicht**  
**La télécommande ne marche pas**  
**El proyector no responde al control remoto**  
**Il proiettore non risponde al telecomando**  
**O projetor não responde ao controle remoto**  
**Fjernkontrollen virker ikke**

1. Verify that working batteries are inserted in the remote  
**Prüfen, ob Batterien fehlen bzw. leer sind und ob die Fernbedienung eingeschaltet ist**  
 Vérifier que des piles sont installées dans la télécommande et qu'elles sont chargées  
**Compruebe que las pilas del mando están correctamente colocadas**  
 Verificare che le batterie del telecomando siano cariche  
**Verifique se as baterias de trabalho foram instaladas no controle remoto**  
 Kontroller om det er satt inn batterier som virker i fjernkontrollen



FixYourDLP.com

Check for other interfering IR sources in the room i.e. fluorescent light tubes, sunlight, active IR COM ports from laptops etc.

Nach anderen störenden Infrarotquellen im Raum suchen, z.B. Leuchtstoffröhren, Sonnenlicht, aktive Infrarot-Anschlüsse von Laptops, etc.

Recherchez dans la pièce d'autres sources IR pouvant interférer: tubes néons, lumière du soleil, ports COM IR actifs de portables, etc.

Compruebe otras posibles fuentes de interferencias de infrarrojos en la habitación, p.e. tubos fluorescentes, luz solar, puerto COM infrarrojo del ordenador activo, etc.

Controllare che nella stanza non vi siano altre sorgenti IR che possano interferire quali tubi luminosi fluorescenti, luce solare, PC portatili con porte COM attive ad IR, ecc.

Veja se há outras fontes de irradiação eletromagnética interferindo no local, ou seja, tubos de luz fluorescente, luz do sol, portas de comunicação a infravermelho de laptops etc.

Kontroller om det finnes andre forstyrrende infrarøde kilder i rommet, f.eks. lysstoffrør, sollys, aktive IR COM-porter på bærbare datamaskiner osv.

THE TRUSTED SOURCE FOR PROJECTOR LAMPS AND ACCESSORIES



| GENERAL CONDITIONS               | ALLGEMEINE DATEN                       | ENVIRONNEMENT                               | CONDICIONES GENERALES                               | CONDIZIONI GENERALI                              | CONDÇÕES GERAIS                              | GENERELLE KRAV                            |  |
|----------------------------------|--|---|---|--|--|---|--|
| Storage temperature, sealevel    | Lagertemperatur, Meeresspiegel         | Température de stockage au niveau de la mer | Temperatura de almacenamiento a nivel del mar       | Temperatura di conservazione, a livello del mare | Temperatura de armazenamento, a nível do mar | Temperatur ved lagring, havflaten         | -20 - 60 °C<br>-4 - 140 F  |
| Storage humidity, non-condensing | Lagerfeuchtigkeit, nicht kondensierend | Humidité de stockage, sans-condensation     | Humedad relativa de almacenamiento sin condensación | Umidità di conservazione, senza condensa         | Umidade de armazenamento, sem condensação    | Fuktighet ved lagring, ikke-kondenserende | 10 -90 % RH  |
| Operating temperature ambient    | Raumtemperatur für Betrieb             | Température ambiante de fonctionnement      | Temperatura ambiente de funcionamiento              | Temperatura di funzionamento ambiente            | Temperatura de funcionamento                 | Romtemperatur ved bruk                    | 5 - 35 °C at sea level<br>5 - 30 °C 3000m<br>41 - 95 F at sea level<br>41 - 86 F 10000 ft. |
| Operating humidity               | Betriebsfeuchtigkeit                   | Humidité de fonctionnement                  | Humedad relativa de funcionamiento                  | Umidità di funzionamento                         | Umidade de funcionamento                     | Fuktighet ved bruk                        | 20 - 80 % RH<br>Allow for slow acclimatization at high humidity                            |

| PROJECTOR UNIT      | PROJEKTOR          | PROJETEUR                               | PROYECTOR                          | UNITÀ DEL PROIETTORE                | PROJETOR                          | PROJEKTOR-ENHETEN   |   |
|---------------------|--------------------|---|------------------------------------|-------------------------------------|-----------------------------------|---------------------|---|
| Dimensions (HxWxL)  | Maße (HxBxL)       | Encombrement (HxPxL)                    | Dimensiones (Alto x Ancho x Largo) | Dimensioni (Alt. x Largh. x Lungh.) | Dimensões (Alt. x Larg. x Comp.)  | Størrelse (HxBxL)   | 84 x 215 x 285 mm<br>3.3 x 8.46 x 11.22 inch                            |
| Weight              | Gewicht            | Poids                                   | Peso                               | Peso                                | Peso                              | Vekt                | 2.4 kg / 5.3 lbs  |
| Ceiling mount       | Deckenmontage      | Montage au plafond                      | Soporte de techo                   | Montaggio a soffitto                | Montagem de teto                  | Takbeslag           | UL tested / listed ceiling mount with capacity of minimum 10kg / 22 lbs |
| Projection lens     | Linse              | Objectif                                | Lente de proyección                | Lente di proiezione                 | Lente de projeção                 | Projeksjonslinse    | 1.3 Zoom Ratio<br>f = 21.5 - 28 mm<br>F / 1.7 - 1.9                     |
| Projection distance | Projektionsabstand | Distance de projection                  | Distancia de proyección            | Distanza di proiezione              | Distância de projeção             | Projeksjonsavstand  | 1 - 7.8 m<br>3.6 - 26.2.ft.   |
| Keystone correction | Trapezentzerrung   | Compensation de distorsion trapézoïdale | Corrección de la clave             | Correzione della deformazione       | Correção da distorção trapezoidal | Keystone-korreksjon | 11.5 - 15.5 °Optical  |
| Projection lamp     | Projektionslampe   | Lampe de projection                     | Lámpara para proyección            | Lampadina di proiezione             | Lâmpada de projeção               | Projeksjonslampe    | 132 W UHP / 2000 hours  |
| Light output        | Lichtstrom         | lumineuse intensité                     | Salida de luz                      | Emissione luminosa                  | Saída de Luz                      | Lysstrøm            | 1000 (SVGA)<br>1100 (XGA) Ansi lumens                                   |
| Noise level         | Geräuschpegel      | Niveau sonore                           | Nivel de ruidos                    | Livello di rumore                   | Nivel de barulho                  | Støynivå            | <34 dB (A) (typ)  |
| Display             | Anzeige            | Affichage                               | Presentación en pantalla           | Display                             | Tela de exibição                  | Bildeprocessor      | 0.7" PolySilicon LCD x 3  |
| Pixels              | Auflösung          | Résolution                              | Pixels                             | Pixel                               | Resolução                         | Piksler             | SVGA: 800 x 600 x 3<br>XGA: 1024 x 768 x 3                              |
| Colors              | Farben             | Couleurs                                | Colores                            | Colori                              | Cores                             | Farger              | 16.7 MILLION  |
| Contrast            | Kontrast           | Contraste                               | Contraste                          | Contrasto                           | Contrase                          | Kontrast            | 400 : 1   |

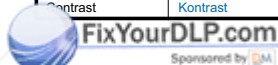

**Discount-Merchant.com (800) 281-8860**  
**THE TRUSTED SOURCE FOR PROJECTOR LAMPS AND ACCESSORIES**

Specifications are subject to change without prior notice Die technischen Daten können ohne Vorankündigung geändert werden Les spécifications peuvent être modifiées sans préavis  
 Las especificaciones podrán ser modificadas sin aviso previo Le specifiche sono passibili di modifica senza preavviso As especificações são sujeitas a mudanças sem aviso prévio  
 Spesifikasjonene kan endres uten varsel

| PROJECTOR UNIT  | PROJEKTOR/<br>GERÄT   | PROJETEUR   | PROYECTOR  | UNITÀ DEL<br>PROIETTORE  | PROJETOR  | PROJEKTOR-<br>ENHETEN   |  |
|---|---|---|--|--|---|---|--|
| Video frequency   | Videofrequenz   | Entrée ordinateur   | Frecuencia de video  | Frequenza video  | Frequência de vídeo   | Videofrekvens   | 12-140 MHz   |
| Horizontal sync.  | Horizontalfrequenz  | Sync. horizontale   | Sinc. horizontal   | Sinc. orizz  | HorizontalSinc.   | Horizontal synk.  | 15-100 KHz   |
| Vertical sync.  | Verticalfrequenz  | Sync. verticale   | Sinc. vertical   | Sinc. vert.  | VerticalSinc.   | Vertikal synk.  | 43.5-130 Hz  |
| Computer input  | Computereingang   | Entrée ordinateur   | Entrada de señal del ordenador   | Ingresso computer  | Entrada Computador  | Datamaskin-inngang  | 0.5 - 1 Vpp  |
| Audio input   | Audioeingang  | Entrée audio  | Entrada de audio   | Ingresso audio   | Entrada de áudio  | Lydinggang  | 1 VRMS   |
| Speakers  | Lautsprecher  | Haut-parleurs   | Altavoces*   | Altoparlanti   | Alto-falantes   | Høytalere   | 2 x 1 W  |
| Conformance   | Prüfzeichen   | Conformité  | Homologación   | Conformità   | Conformidade  | Oppfyller kravene til   | CE. UL. GOST R. CUL. FCC Class A Subpart J. Part 15  |
| Power supply  | Stromversorgung   | Alimentation électrique   | Suministro de corriente  | Alimentazione elettrica  | Fonte de alimentação  | Strømforsyning  | 90 - 264 VAC, 47 - 63 HZ 2.5 / 1 A   |
| Computer compatibility resized to native pixel resolution | Computer-kompatibilität. Resizing auf Originalauflösung (Pixel) | Compatibilité ordinateur au redimensionnement de la résolution d'origine (pixels) | Compatibilidad del ordenador ajustada a la resolución pixels. Resolución en pixels | Compatibilità computer (riclassificata in base alla risoluzione pixel orginaria) | Compatibilidade do computador ajustada à resolução de origem (pixels) | Datamaskin-kompatibilitet, størrelse endret til naturlig pikseloppløsning | 640x480<br>720x400<br>800x600<br>832x624<br>1024x768<br>1152x864<br>1152x870<br>1280x1024<br>1400x1050 |
| Supported color system                                    | Unterstütztes Farbsystem  | Système de télévision en couleurs supporté  | Sistema de color soportado   | Sistema di colore soportato  | Sistema de cores suportado  | Fargesystem som støttes   | PAL BHGI, N, combination N, M NTSC M, 4.43, Japan, SECAM, MESECAM                                      |

| PROJECTION DISTANCES | PROJEKTIONS-<br>ABSTÄNDE | DISTANCES DE<br>PROJECTION | DISTANCIAS DE<br>PROYECCIÓN | DISTANZE DI<br>PROIEZIONE | DISTÂNCIAS DE<br>PROJEÇÃO | PROJEKSJONS-<br>AVSTANDER |                 |
|----------------------|--------------------------|----------------------------|-----------------------------|---------------------------|---------------------------|---------------------------|-----------------|
| WIDE                 | WEITWINKEL               | GRAND ANGLAIRE             | GRAN ANGULAR                | GRANDANGOLO               | GRÃ ANGULAR               | VIDWINKEL                 |                 |
| 1200 mm              | 1200 mm                  | 1200 mm                    | 1200 mm                     | 1200 mm                   | 1200 mm                   | 1200 mm                   | 40° (Diagonal)  |
| 1500 mm              | 1500 mm                  | 1500 mm                    | 1500 mm                     | 1500 mm                   | 1500 mm                   | 1500 mm                   | 50° (Diagonal)  |
| 1800 mm              | 1800 mm                  | 1800 mm                    | 1800 mm                     | 1800 mm                   | 1800 mm                   | 1800 mm                   | 60° (Diagonal)  |
| 3000 mm              | 3000 mm                  | 3000 mm                    | 3000 mm                     | 3000 mm                   | 3000 mm                   | 3000 mm                   | 100° (Diagonal) |
| 4500 mm              | 4500 mm                  | 4500 mm                    | 4500 mm                     | 4500 mm                   | 4500 mm                   | 4500 mm                   | 150° (Diagonal) |
| 6000 mm              | 6000 mm                  | 6000 mm                    | 6000 mm                     | 6000 mm                   | 6000 mm                   | 6000 mm                   | 200° (Diagonal) |
| TELE                 | TELEOBJEKTIV             | TELEOBJECTIF               | TELEOBJETIVO                | TELEOBBIETTIVO            | TELEOBJETIVA              | TELE                      |                 |
| 1560 mm              | 1560 mm                  | 1560 mm                    | 1560 mm                     | 1560 mm                   | 1560 mm                   | 1560 mm                   | 40° (Diagonal)  |
| 1950 mm              | 1950 mm                  | 1950 mm                    | 1950 mm                     | 1950 mm                   | 1950 mm                   | 1950 mm                   | 50° (Diagonal)  |
| 2340 mm              | 2340 mm                  | 2340 mm                    | 2340 mm                     | 2340 mm                   | 2340 mm                   | 2340 mm                   | 60° (Diagonal)  |
| 3900 mm              | 3900 mm                  | 3900 mm                    | 3900 mm                     | 3900 mm                   | 3900 mm                   | 3900 mm                   | 100° (Diagonal) |
| 5850 mm              | 5850 mm                  | 5850 mm                    | 5850 mm                     | 5850 mm                   | 5850 mm                   | 5850 mm                   | 150° (Diagonal) |
| 7800 mm              | 7800 mm                  | 7800 mm                    | 7800 mm                     | 7800 mm                   | 7800 mm                   | 7800 mm                   | 200° (Diagonal) |



**Discount-Merchant.com (800) 281-8860**  
**THE TRUSTED SOURCE FOR PROJECTOR LAMPS AND ACCESSORIES**

Specifications are subject to change without prior notice Die technischen Daten können ohne Vorankündigung geändert werden Les spécifications peuvent être modifiées sans préavis  
 Las especificaciones podrán ser modificadas sin aviso previo Le specifiche sono passibili di modifica senza preavviso As especificações são sujeitas a mudanças sem aviso prévio  
 Spesifikasjonene kan endres uten varsel

| CONNECTORS   | ANSCHLÜSSE  | CONNECTEURS   | CONECTORES   | CONNETTORI   | CONECTORES   | KONTAKTER   |
|--|---|---|--|--|--|---|
|  |   |   |  |  |  |   |
| <b>S-Video</b><br>4 PIN MINIDIN FEMALE<br>1 GND<br>2 GND<br>3 Luma<br>4 Chroma | <b>Video</b><br>PHONO/RCA FEMALE<br>STEM: composite<br>SHIELD:GND | <b>Computer VGA</b><br>15 HIGH DENSITY DSUB FEMALE<br>1 Analog R in<br>2 Analog G in<br>3 Analog B in<br>4 AGND<br>5 AGND<br>6 Analog R GND in<br>7 Analog G GND in<br>8 Analog B GND in<br>9 Reserved<br>10 Sync GND in<br>11 AGND<br>12 DDC/SDA<br>13 HSync in<br>14 VSync in<br>15 DDC/SCL | <b>Monitor VGA</b><br>15 HIGH DENSITY DSUB FEMALE<br>1 Analog R in<br>2 Analog G in<br>3 Analog B in<br>4 AGND<br>5 AGND<br>6 Analog R GND in<br>7 Analog G GND in<br>8 Analog B GND in<br>9 Reserved<br>10 Sync GND in<br>11 AGND<br>12 DDC/SDA<br>13 HSync in<br>14 VSync in<br>15 DDC/SCL | <b>Audio in</b><br>3.5 MM JACK<br>TIP: right<br>RING: left<br>STEM: common | <b>PS2/RS-232</b><br>8 PIN MINIDIN FEMALE<br>1 Mac ADB<br>2 PS/2 clock<br>3 PS/2 data<br>4 RS 232 TXD<br>5 Not used<br>6 RS 232 RXD<br>7 RS 232 CTS<br>8 GND | <b>USB</b><br>DIGITAL USB<br>1 VCC<br>2 -Data<br>3 +Data<br>4 GND |
|  |   |   |  |  |  |   |

**⚠ This product contains no user serviceable parts. Attempts to modify mechanics or electronics inside the housing will violate any warranties, and may be hazardous.**

If for any reason the product fails to work properly, please contact your dealer for technical support. Prepare a list of the symptoms you observe to make diagnosing easier for your dealer.

Please also include the following:

- Serial number of the unit (SN)
- Part number of the unit (PN)
- Software revision (under main menu selection "SET UP/SERVICE/INFO")
- Connected source information (under main menu selection "BASIC/ABOUT")

**⚠ Dieses Gerät enthält keine Verschleißteile. Der Versuch, elektronische oder mechanische Komponenten im Gehäuse zu manipulieren führt zum Verlust der Garantie und kann eine Gefahr für den Benutzer darstellen.**

Sollte das Gerät aus welchem Grund auch immer nicht korrekt funktionieren, wenden Sie sich bitte an Ihren Händler. Bitte halten Sie die auftretenden Probleme schriftlich fest. Damit erleichtern Sie Ihrem Händler die Fehlerdiagnose.

Bitte halten Sie auch folgende Daten bereit:

- Seriennummer des Geräts (SN)
- Teilnummer des Geräts (PN)
- Versionsnummer der Software (im Hauptmenü unter "EINSTELLUNGEN/SERVICE/INFO")
- Information über angeschlossene Quelle (im Hauptmenü unter "GRUNDLEGENDES/ÜBER")

**⚠ Aucune des pièces de ce produit n'est réparable par l'utilisateur. Les tentatives de modification des parties mécaniques ou électroniques de l'appareil annuleront toute garantie et peuvent être dangereuses.**

Si le produit ne fonctionnait pas correctement, prenez contact avec votre concessionnaire. Préparez au préalable une liste des symptômes que vous avez observés pour que votre concessionnaire établisse plus aisément le diagnostic.

Veillez inclure les renseignements suivants:

- Numéro de série de l'unité (SN)
- Numéro de la pièce de l'unité (PN)
- Révision du logiciel (Sélectionnez "RÉGLAGE/SERVICE/INFO" dans le menu principal)
- Les renseignements concernant la source connectée (sélectionnez ESSENTIEL/À PROPOS dans le menu principal)

**⚠ Este producto no contiene ninguna pieza útil para el usuario. Cualquier intento de modificar la mecánica o electrónica incluida en la carcasa anulará la garantía, y puede resultar peligroso.**

Si por cualquier motivo el producto no funciona correctamente, póngase en contacto con su distribuidor para obtener asistencia técnica. Prepare una lista de los problemas que haya observado para facilitar su diagnóstico.

Incluya además los siguientes datos:

- Número de serie de la unidad (SN)
- Número de pieza de la unidad (PN)
- Revisión de software (consultar seleccionando "CONFIGURACIÓN/SERVICIO/INFORMACIÓN" en el menú principal)
- Información sobre fuentes conectadas (en BÁSICO/ACERCA del menú principal)

**⚠ Questo prodotto non contiene parti sostituibili dall'utente. Qualsiasi tentativo di modificare parti meccaniche o elettroniche interne alla scatola renderà nulla la garanzia e può risultare pericoloso.**

Se per qualsiasi motivo il prodotto non funziona adeguatamente, si prega di contattare il rivenditore per l'assistenza tecnica. Preparare una lista dei sintomi osservati per rendere più facile la diagnosi al rivenditore.

Si prega anche di includere le seguenti informazioni:

- Numero di serie dell'apparecchiatura (SN)
- Numero del pezzo dell'apparecchiatura (PN)
- Revisione del software (vedere nel menù principale alla selezione "IMPOSTAZIONI/SERVIZIO/INFORMAZIONI")
- Informazioni sulla sorgente collegata (vedere nel menù principale alla selezione INFORMAZIONI DI BASE/INFORMAZIONI SU)

**⚠ Este produto não contém peças úteis ao usuário. Tentativas de modificação da mecânica ou eletrônica interna violará qualquer garantia e pode ser perigoso.**

Se por qualquer razão o produto não funcionar corretamente, por favor contate o distribuidor para suporte técnico. Prepare uma lista dos sintomas observados a fim de facilitar o diagnóstico para o distribuidor.

Por favor também inclua o seguinte:

- Número de série da unidade (SN)
- Número da peça da unidade (PN)
- Revisão do software (no menu principal - seleção "CONFIGURACÃO/SERVICO/INFORMACÃO")
- Informação da fonte conectada (no menu principal - seleção BÁSICO/SOBRE)

Sponsored by

**⚠ Dette produktet inneholder ingen deler som brukerne kan utføre service på. Forsøk på å endre mekaniske eller elektroniske komponenter innenfor dekslet vil gjøre alle garantier ugyldige, og kan også være farlig.**

Hvis produktet av en eller annen grunn ikke virker som det skal, må du kontakte forhandleren for å få teknisk brukerstøtte. Lag en liste over symptomene du ser, slik at det blir lettere for forhandleren å finne ut hva problemet skyldes.

Ta også med følgende:

- Enhetens serienummer (SN)
- Enhetens delenummer (PN)
- Programvareversjon (under hovedmenyvalget "OPPSETT/SERVICE/INFO")
- Informasjon om tilkoblede kilder (under hovedmenyvalget "BASIC/OM")



**Disconnect power**

**Netzstecker ziehen**

**Débranchez l'appareil**

**Desconecte la corriente**

**Scollegare l'alimentazione**

**Desligue a alimentação**

**Trekk ut strømledningen**



1

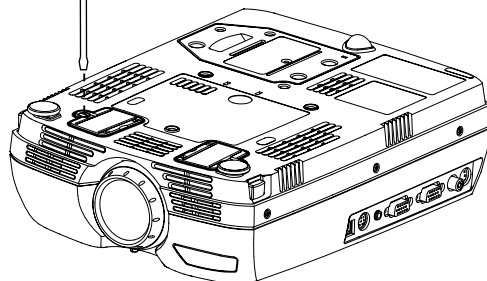

1. Remove screws to access the dust filter  
**Entfernen Sie die Schrauben, um Zugriff auf den Staubfilter zu haben**  
Dévisser les vis pour atteindre le filtre à poussière  
Extraiga los tornillos para acceder al filtro de polvo  
Togliere le viti per accedere al filtro antipolvere  
Retire os parafusos para obter acesso ao filtro de pó  
Fjern skruene for å komme til støvfilteret

2. Carefully remove the dustfilter  
**Staubfilter vorsichtig entfernen**  
Enlevez le filtre à poussière avec précautions  
**Retire con cuidado el filtro del polvo**  
Togliere attentamente il filtro della polvere  
**Remova cuidadosamente o filtro do po**  
Forsiktig fjern støvfilteret

3. Clean dustfilter  
**Staubfilter reinigen**  
Nettoyez le filtre à poussière  
**Limpie el filtro del polvo**  
Pulire il filtro della polvere  
**Limpe o filtro do pó**  
Rens støvfilteret

4. Replace clean dustfilter and tighten screws  
**Gereinigten Staubfilter wieder einlegen und die Schrauben festziehen**  
Remettez le filtre à poussière en place, et serrez les vis  
**Coloque de nuevo el filtro del polvo limpio, y apriete los tornillos**  
Sostituire il filtro della polvere pulito, e avvitare le viti  
**Coloque o filtro do pó limpo, e aperte os parafusos**  
Sett tilbake rent støvfilter, og stram festeskrueene

5. Clean all air intakes, ref. chap. B  
**Alle Lufteinlässe reinigen. Siehe Kap. B**  
Nettoyez toutes les entrées d'air. Voir Chap. B  
**Limpie todas las tomas de aire. Ref. Cap. B**  
Pulire tutte le prese d'aria. Rif. Cap. B  
**Limpe todas as entradas de admissão do ar. Ref. Cap. B**  
Rens alle luft innsug. Se Kap. B

2 & 4

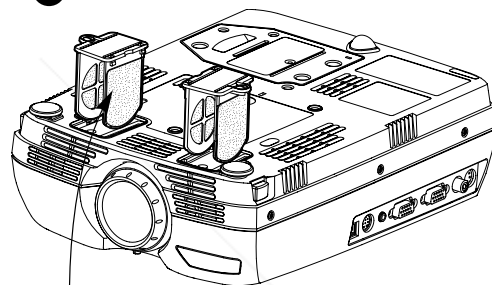

3

**Clean the air intakes regularly for sufficient air flow**

**Reinigen Sie die Eingangsschlitze für die Belüftung regelmäßig, um einen ausreichenden Luftstrom zu gewährleisten**

**Nettoyer la prise d'air régulièrement pour maintenir une aération suffisante**

**Limpie periódicamente las entradas de aire, para que haya suficiente caudal**

**Pulire le prese d'aria regolarmente per consentire un flusso di aria adeguato**

**Limpar regularment as entradas de ar para obter vazão de ar suficiente**

**Reiniger luftinntakene jevnlign for å sikre tilstrekkelig luftgjennomstrømming**



**FixYourDLP.com**

Sponsored by DLP



**Refer service to qualified personnel only**

**Reparaturen sind von Fachpersonal durchzuführen**

**Confier toute intervention à un professionnel qualifié**

**La asistencia técnica debe realizarse por personal cualificado**

**Eventuali riparazioni devono essere effettuate esclusivamente da personale qualificato**

**Remeta a assistência somente a pessoal qualificado**

**All service må overlates til kvalifisert personell**

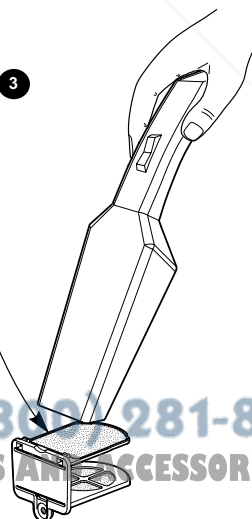



# LAMP REPLACEMENT

LAMPENAUSTAUSCH    REMPLACEMENT DE LA LAMPE

SUSTITUCIÓN DE LA BOMBILLA    SOSTITUZIONE LAMPADINA    SUBSTITUIÇÃO DA LÂMPADA    LAMPESKIFT

**Change lamp when lifetime expired. Replace expired lamp only with same type and rating**

**Lampe nach Ablauf der Lebensdauer austauschen. Nur Lampen gleicher Art und Stärke verwenden**

**Changez la lampe lorsque sa durée de vie arrive à expiration. Ne remplacez la lampe que par une lampe ayant les mêmes caractéristiques.**

**Cambie la lámpara al término de su vida útil. Sustituya siempre la lámpara gastada por otra del mismo tipo y capacidad**  
**Sostituire la lampada quando termina la sua vita utile. Sostituire la lampada utilizzando unicamente una della stesso tipo e caratteristiche**  
**Troque a lâmpada quando o tempo útil de vida expirar. Substitua a lâmpada gasta somente por outra do mesmo tipo e valor nominal**  
**Skift lampe når levetiden er overskredet. Bruk kun lampe av samme type og med samme effekt**



**Disconnect power. Wait 60 minutes before opening lamp housing**

**Netzstecker ziehen. Warten Sie 60 Minuten, bevor Sie die Lampentüre öffnen**

**Débrancher. Attendre 60 minutes avant d'ouvrir la porte du logement de la lampe**

**Desconecte la corriente. Espere 60 minutos antes de abrir la cubierta de la bombilla**

**Scolligare la corrente. Attendere 60 minuti prima di aprire la porta della lampadina**

**Desligue da força. Aguarde 60 minutos antes de abrir a porta da lâmpada**

**Trekk ut strømledningen. Vent 60 minutter før lampeholderen åpnes**



1 & 4

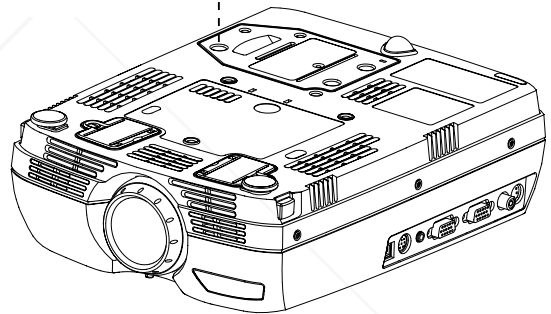

2 & 3

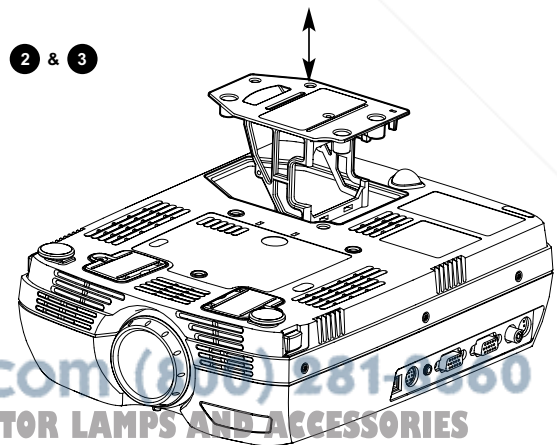

1. Open screws on lamp housing

Schrauben des Lampengehäuses öffnen

Dévissez les vis du logement de la lampe

Abra los tornillos del alojamiento de la lámpara

Svitare le viti della lampada

Desaperte os parafusos do alojamento da lâmpada

Løsne skruene til lampeholderen

2. Carefully pull out and remove lamp housing

Lampengehäuse vorsichtig herausnehmen

Tirez avec précautions sur le logement de la

lampe pour l'enlever

Extraiga cuidadosamente el alojamiento de la lámpara

Tirare attentamente verso fuori e togliere la sede

della lampada

Puxe cuidadosamente para fora e remova o alojamento da lâmpada

Forsiktig fjern lampeholderen

3. Insert new lamp housing

Neues Lampengehäuse einsetzen

Posez le nouveau logement de la lampe

Introduzca el nuevo alojamiento de la lámpara

Inserire la nuova sede della lampada

Insira um novo alojamento da lâmpada

Sett tilbake ny lampeholder

4. Tighten screws

Schrauben festziehen

Serrez les vis

Apriete los tornillos

Avvitare le viti

Aperte os parafusos

Stram skruene



lamp timer. Ref. Chapter H

Lebstundenzähler auf Null setzen. Siehe Kap. H

Remettez le compteur de la lampe à zéro. Voir Chap. H

Reinicie el temporizador de la lámpara. Ref. Cap. H

Azzerare il temporizzatore della lampada. Rif. Cap. H

Efetue o reinicio do temporizador da lâmpada. Ref. Cap. H

Tilbakesstill tellerverket for lampen. Se Kap. H



**FCC WARNING**

This equipment has been tested and found to comply with the limits for a Class A digital device, pursuant to part 15 of the FCC Rules. These limits are designed to provide reasonable protection against harmful interference when the equipment is operated in a commercial environment. This equipment generates, uses, and can radiate radio frequency energy and, if not installed and used in accordance with the instruction manual, may cause harmful interference to radio communications. Operation of this equipment in a residential area is likely to cause harmful interference in which case the user will be required to correct the interference at his own expense.

**EN 55022 WARNING**

This is a Class A product. In a domestic environment it may cause radio interference, in which case the user may be required to take adequate measures. The typical use is in a conference room, meeting room or auditorium.



**Discount-Merchant.com (800) 281-8860**  
**THE TRUSTED SOURCE FOR PROJECTOR LAMPS AND ACCESSORIES**





# Disclaimer

This user manual is provided as a free service by FixYourDLP.com. FixYourDLP is in no way responsible for the content of this manual, nor do we guarantee its accuracy. FixYourDLP does not make any claim of copyright and all copyrights remain the property of their respective owners.

About FixYourDLP.com

FixYourDLP.com (<http://www.fixyourdpl.com>) is the World's #1 resource for media product news, reviews, do-it-yourself guides, and manuals.

Informational Blog: <http://www.fixyourdpl.com>

Video Guides: <http://www.fixyourdpl.com/guides>

User Forums: <http://www.fixyourdpl.com/forum>

FixYourDLP's Fight Against Counterfeit Lamps:

<http://www.fixyourdpl.com/counterfeits>

## Sponsors:

RecycleYourLamp.org – Free lamp recycling services for used lamps:

<http://www.recycleyourlamp.org>

Lamp Research - The trusted 3rd party lamp research company:

<http://www.lampresearch.com>

Discount-Merchant.com – The worlds largest lamp distributor:

<http://www.discount-merchant.com>



**FixYourDLP.com**

Sponsored by 