



Disclaimer

This user manual is provided as a free service by FixYourDLP.com. FixYourDLP is in no way responsible for the content of this manual, nor do we guarantee its accuracy. FixYourDLP does not make any claim of copyright and all copyrights remain the property of their respective owners.

About FixYourDLP.com

FixYourDLP.com (<http://www.fixyourdlp.com>) is the World's #1 resource for media product news, reviews, do-it-yourself guides, and manuals.

Informational Blog: <http://www.fixyourdlp.com>

Video Guides: <http://www.fixyourdlp.com/guides>

User Forums: <http://www.fixyourdlp.com/forum>

FixYourDLP's Fight Against Counterfeit Lamps:

<http://www.fixyourdlp.com/counterfeits>

Sponsors:

RecycleYourLamp.org – Free lamp recycling services for used lamps:

<http://www.recycleyourlamp.org>

Lamp Research - The trusted 3rd party lamp research company:

<http://www.lampresearch.com>

Discount-Merchant.com – The worlds largest lamp distributor:

<http://www.discount-merchant.com>



FixYourDLP.com

Sponsored by 



Discount-Merchant.com (800) 281-8860

THE TRUSTED SOURCE FOR PROJECTOR LAMPS AND ACCESSORIES

Copyright © 2001 by Boxlight
Poulsbo, Washington. All rights reserved.

FCC Warning

This equipment has been tested and found to comply with the limits for a Class A digital device, pursuant to part 15 of the FCC Rules. These limits are designed to provide reasonable protection against harmful interference when the equipment is operated in a commercial environment. This equipment generates, uses, and can radiate radio frequency energy and, if not installed and used in accordance with the instruction manual, may cause harmful interference to radio communications. Operation of this equipment in a residential area is likely to cause harmful interference in which case the user will be required to correct the interference at his own expense.

Canada

This Class A digital apparatus complies with Canadian ICES-003.
Cet appareil numérique de la classe A est conforme à la norme NMB-003 du Canada.

Safety Certifications

UL, CUL, TÜV, NOM

EN 55022 Warning

This is a Class A product. In a domestic environment it may cause radio interference, in which case the user may be required to take adequate measures.



Discount-Merchant.com (800) 281-8860
THE TRUSTED SOURCE FOR PROJECTOR LAMPS AND ACCESSORIES

Declaration of Conformity

Manufacturer: Boxlight

19332 Powder Hill Place, Poulsbo, Washington, USA

We declare under our sole responsibility that the XD-10m projector conforms to the following directives and norms:

Directive 89/336/EEC, Amended by 93/68/EEC

EMC: EN 55022

EN 55024

EN 61000-3-2

EN 61000-3-3

Directive 73/23/EEC, Amended by 93/68/EEC

Safety: EN 60950: 1992 + A1 + A2 + A3 + A4: 1997

March, 2001

Trademarks

Apple, Macintosh, and PowerBook are trademarks or registered trademarks of Apple Computer, Inc. IBM and PS/2 are trademarks or registered trademarks of International Business Machines, Inc. Microsoft, PowerPoint, and Windows are trademarks or registered trademarks of Microsoft Corporation. Digital Light Processing is a trademark or registered trademark of Texas Instruments.



Discount-Merchant.com (800) 281-8860
THE TRUSTED SOURCE FOR PROJECTOR LAMPS AND ACCESSORIES



Discount-Merchant.com (800) 281-8860
THE TRUSTED SOURCE FOR PROJECTOR LAMPS AND ACCESSORIES

TABLE OF CONTENTS

Safety Instructions	iii
Introduction	I
Image Resolution	1
Compatibility	1
Unpacking the Projector	1
Usage Guidelines	3
If You Need Assistance	4
Warranty	4
Setting up the Projector	5
Connecting a Computer	7
Connecting a Video Player	8
Powering up the Projector and Adjusting the Image	9
Turning Off the Projector	9
Using the Projector	II
Basic Image Adjustment	11
Adjusting the Projector	11
Using the Remote Control	13
Using the Keypad and Remote Buttons	14
Using the On-Screen Menus	16
Display Menu	17
Image Menu for Computer Sources	19
Image Menu for Video Sources	21
Control Menu	22
Advanced Menu	23
Language Menu	24
Status Menu	25
Maintenance & Troubleshooting	27
Cleaning the Lens	27
Replacing the Projection Lamp	27
Replacing the Batteries in the Remote Control	31
Using the Security Lock	31
Troubleshooting	32

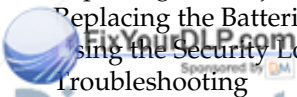

Discount-Merchant.com (800) 281-8860
THE TRUSTED SOURCE FOR PROJECTOR LAMPS AND ACCESSORIES

Appendix	35
Specifications	35
Accessories	36
Portable and Laptop Activation Chart	38
Using Video Mirroring with a PowerBook Computer	43
Projected Image Size	44
Index	45



Discount-Merchant.com (800) 281-8860
THE TRUSTED SOURCE FOR PROJECTOR LAMPS AND ACCESSORIES

SAFETY INSTRUCTIONS

Please read and follow all safety instructions provided BEFORE using your new projector. Failure to comply with safety instructions may result in fire, electrical shock, or personal injury and may damage or impair protection provided by equipment. Please save all safety instructions.

Safety Definitions:

- **Warning:** Statements identify conditions or practices that could result in personal injury.
- **Caution:** Statements identify conditions or practices that could result in damage to your equipment.

Safety Symbols:



Attention: For information about usage of a feature, please refer to the User's Guide.



Warning: Hot surface. Do not touch.



An arrow pointing to the lamp door on the projector.

Safety Terms:

- **Warning:** Don't look directly into the lens when the projector is turned on.



• **Warning:** To replace the lamp, turn the projector off and unplug the power cord. To avoid burns, wait 30 minutes before opening the lamp access grill. Follow all instructions provided in this User's Guide.



• **Warning:** Please use the power cord provided.



FixYourDLP.com

Warning: Refer all service to qualified service personnel. Servicing your own projector will void the warranty. See the following page for the customer service contact information.

- **Caution:** Don't block ventilation openings.

Discount-Merchant.com (800) 281-8860
THE TRUSTED SOURCE FOR PROJECTOR LAMPS AND ACCESSORIES

- **Caution:** Don't set liquids on the projector. Spilled liquids may damage your projector.
- **Caution:** Don't place the projector on a hot surface or in direct sunlight.
- **Caution:** Do not drop the projector. Transport the projector in a Boxlight-approved case; see page 37 for a list of cases.

Important Operating Considerations

Do not place the projector on a tablecloth or other soft covering that may block the vents. In the unlikely event of the bulb rupturing, thoroughly clean the area in front of the projector and discard any edible items placed in that area.

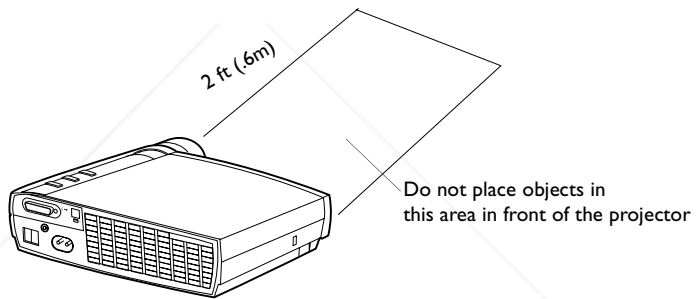

Customer Service

If you need assistance, call Boxlight at **1-800-762-5757** or **360-779-7901**.



Discount-Merchant.com (800) 281-8860
THE TRUSTED SOURCE FOR PROJECTOR LAMPS AND ACCESSORIES

INTRODUCTION

The Boxlight® XD-10m™ digital projector is specifically designed for the mobile presenter. It generates crisp, clear images using Digital Light Processing™ (DLP) technology, and features an M1-DA type DVI connector for easy, built-in digital/analog and USB connectivity. It is easy to connect, easy to use, easy to transport, and easy to maintain.

Image Resolution

The XGA resolution of the XD-10m's projected image is 1024x768. The projector is compatible with screen resolutions up to 1280x1024. If your computer's screen resolution is higher than 1280x1024, reset it to a lower resolution before you connect the projector.

Compatibility

The projector is compatible with a wide variety of computers and video devices, including:

- IBM-compatible computers, including laptops, up to 1280x1024 resolution.
- Apple® Macintosh® and PowerBook® computers up to 1280x1024 resolution.
- Most standard VCRs, DVD players, HDTV sources, camcorders and laser disc players.

Unpacking the Projector

The projector comes with the items shown in Figure 1. Check to make sure all are included. **Contact Boxlight immediately if anything is missing.**

If you are experienced in setting up presentation systems, use the *Quick Start* card that was included in the shipping box. For complete details on connecting and operating the projector, refer to this User's Guide.



NOTE: The projector automatically expands 640x480 and 800x600 images to 1024x768. You can display these images at their native resolutions using the *Resize* option in the *Image* menu. See page 19 for more information.



NOTE: The projector is compatible with 1080i and 720P HDTV formats.

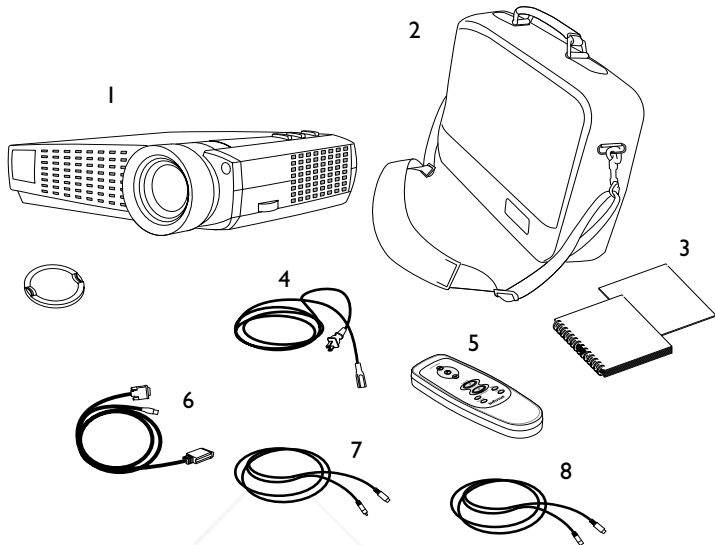

FIGURE I

Shipping box contents

- | | |
|--|--------------------------|
| 1. XD-10m digital projector + lens cap | 5. Remote control |
| 2. Soft carry case | 6. Analog computer cable |
| 3. User's Guide and Quick Start card | 7. Composite video cable |
| 4. Power cord | 8. S-video cable |

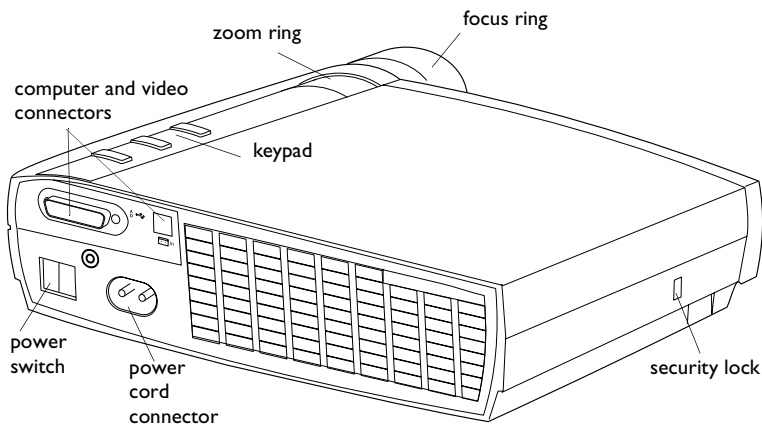

FIGURE 2

Side view of projector

Usage Guidelines

- Do not look directly into the projection lens when the projector is turned on. The bright light may harm your eyes.
- Do not block the grills on the projector. Restricting the air flow can cause it to overheat and turn off. If this happens, you must wait a minute before attempting to turn it back on.
- Handle the projector as you would any product with glass components. Be especially careful not to drop it.
- Avoid leaving the projector in direct sunlight or extreme cold for extended periods of time. If this happens, allow it to reach room temperature before use.
- Transport the projector in a vendor-approved hard or soft case.



Discount-Merchant.com (800) 281-8860
THE TRUSTED SOURCE FOR PROJECTOR LAMPS AND ACCESSORIES

If You Need Assistance

The first place to look for help is in this manual. Be sure to check the guidelines in “Troubleshooting” on page 32.

If this manual doesn’t answer your question, call Boxlight at **1-800-762-5757** or **360-779-7901**.

Warranty

This product is backed by a limited two-year warranty. The details of the warranty are printed at the back of this manual.



Discount-Merchant.com (800) 281-8860
THE TRUSTED SOURCE FOR PROJECTOR LAMPS AND ACCESSORIES

SETTING UP THE PROJECTOR

- 1 Place the projector on a flat surface.
 - The projector must be within 10 feet (3 m) of your power source and within 6 feet (1.8 m) of your computer.
 - If you want to project from behind a translucent screen, set up the projector behind your screen. See “Rear Projection” on page 23 to reverse the image.
- 2 Position the projector the desired distance from the screen.
 - If the image is too big or too small, use the zoom ring to adjust the size or move the projector forward or backward. Figure 3 shows three projected image sizes. For more information about image size, see “Projected Image Size” on page 44.

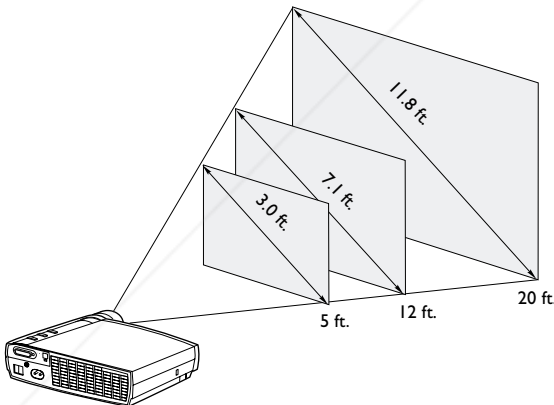

FIGURE 3

Projected image size at minimum zoom

- 3 Make sure the projector and the computer are turned off.



NOTE: Before you continue, make sure the projector and all other equipment is turned off. If you're connecting a computer, make sure the distance between it and the projector is 6 feet or less.

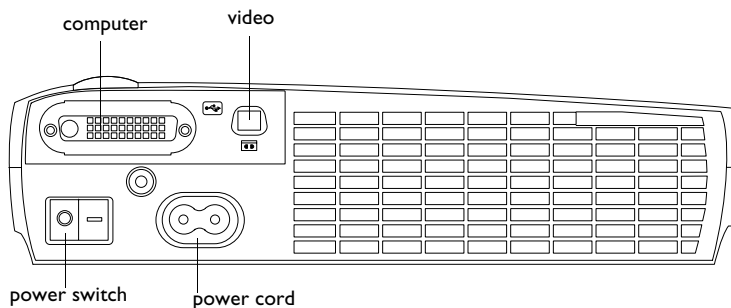

FIGURE 4

Connector panel



FIGURE 5

Computer cable



NOTE: If you are connecting an older Macintosh computer that does not have a 15-pin connector, you must use a Mac adaptor between the computer and the projector. See "Optional Accessories" on page 37.

DiscountMerchant.com (800) 281-8860
 THE TRUSTED SOURCE FOR PROJECTOR LAMPS AND ACCESSORIES

Connecting a Computer

The projector ships with an analog computer cable. If your computer has a digital output, you can order the optional digital computer cable. Using a digital source generates the highest quality and brightest image possible. See “Optional Accessories” on page 37.

- 1 Plug the end of the computer cable with one cable into the connector on the projector.
- 2 Plug the blue end of the computer cable into the video connector on your computer.
- 3 If you want to advance slides in a PowerPoint™ presentation using the remote, plug the USB cable into the USB mouse connector on your computer.

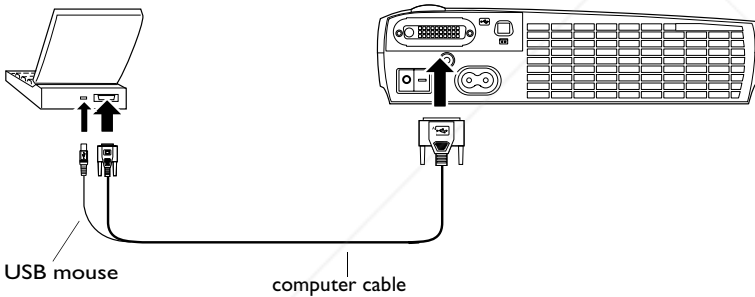

FIGURE 6

Connecting the projector to a computer

Now you're ready to power up the projector and your laptop. Skip to “Powering up the Projector and Adjusting the Image” on page 9.



Discount-Merchant.com (800) 281-8860
THE TRUSTED SOURCE FOR PROJECTOR LAMPS AND ACCESSORIES



NOTE: Many laptop computers do not automatically turn on their external video port when a secondary display device such as a projector is connected. Refer to your computer manual for the command that activates the external video port. Activation commands for some laptop computers are listed in the Appendix of this manual on page 38 and in the Service section of our website.



NOTE: The USB mouse is supported for use with Windows 98, Windows 2000, and Apple OS 8.5 and higher only.



NOTE: You do not need to restart your computer after connecting a USB mouse to use it



NOTE: HDTV sources must be connected to the projector using the computer cable (not the video cable). See the previous pages for details on connecting this cable.

Connecting a Video Player

If your video player uses a round, one-prong composite video connector, use the composite video cable. If your video player uses a round, four-prong S-video connector, use the S-video cable. S-video generates a higher quality image.

- 1 Plug the composite video cable's round yellow connector into the "video-out" connector on your video player (Figure 7). This connector may be labeled "To Monitor."

 - If you're using an S-video cable, connect the round black connector to the "S-video out" connector on the video player.

- 2 Plug the square yellow connector into the video connector on the projector.

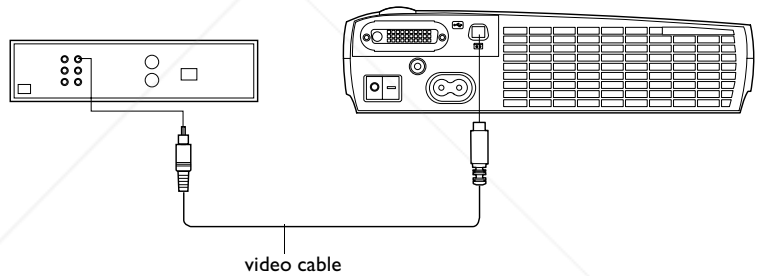

FIGURE 7

Connecting the projector to a video player



CAUTION: Your video player may also have a "Video Out" connector for a coaxial cable connection. DO NOT use this to connect to the projector.

The projector is compatible with these major broadcast video standards: NTSC, NTSC 4.43, PAL, PAL-M, PAL-N, PAL-60, and SECAM. It automatically adjusts to optimize its performance for the incoming video.



Discount-Merchant.com (800) 281-8860
THE TRUSTED SOURCE FOR PROJECTOR LAMPS AND ACCESSORIES

Powering up the Projector and Adjusting the Image

- 1 Remove the lens cap.
- 2 Plug the power cord into the back of the projector, then plug it into your electrical outlet. A surge-protected power strip is recommended.
- 3 Press the Power switch on the back of the projector.
 - The fans start to run, the LED on the top of the projector (Figure 11 on page 14) lights green, and the startup screen appears. It takes about one minute for the image to achieve full brightness.
- 4 If you connected a video player, turn it on.
 - The video image should display on the projection screen. If it doesn't, press the **source** button on the keypad (page 14) or the **video** button on the remote to display your video image.
- 5 Turn on your computer.
 - The computer image should display on the projection screen. If it doesn't, press the **source** button on the keypad or the **data** button on the remote to display your computer's image.
 - Make sure your laptop's external video port is activated; see "Portable and Laptop Activation Chart" on page 38 for details.
 - If necessary, make adjustments to the image using the projector's on-screen menus. To open the menus, press the **menu/select** button on the keypad or remote. For more information about the menus, see page 16.

Turning Off the Projector

To turn off the projector, press the Power switch. If you want to turn the lamp back on, you must allow 90 seconds for the lamp to cool. The lamp won't light if it's too hot.



NOTE: Always use the power cord that shipped with the projector.



NOTE: The first time you connect your computer to the projector, the computer may display a message stating that new hardware was found. The Add New Hardware Wizard may appear. Use the Wizard to load the correct driver (the computer considers the projector a Plug and Play Monitor).



NOTE: With some computers, the order in which you power up the equipment is very important. Most computers should be turned on last, after all other peripherals have been turned on. Refer to your computer's documentation to determine the correct order.



NOTE: To maximize lamp life, allow the projector to run for at least five minutes before turning it off.



FixYourDLP.com
Discount-Merchant.com (800) 281-8860
THE TRUSTED SOURCE FOR PROJECTOR LAMPS AND ACCESSORIES



Discount-Merchant.com (800) 281-8860
THE TRUSTED SOURCE FOR PROJECTOR LAMPS AND ACCESSORIES

USING THE PROJECTOR

This section describes how to use and make adjustments to the projector. It also provides a reference to the keypad and remote buttons and the options available from the on-screen menus.

Basic Image Adjustment

- 1 Make sure you have powered up your equipment in the right order (page 9).
- 2 If the image doesn't display completely, zoom the image (page 11), adjust the height of the projector (page 12) or center the image by adjusting its horizontal or vertical position (page 20). Be sure the projector is at a 90 degree angle to the screen.
- 3 If the image is out of focus, rotate the focus lens (page 11).
- 4 If the colors don't look right, adjust the brightness, contrast, tint, or color (page 17).

Adjusting the Projector

To focus the image, rotate the focus ring (Figure 8) until the image is clear. To zoom the image, rotate the zoom ring. This adjusts the image size.

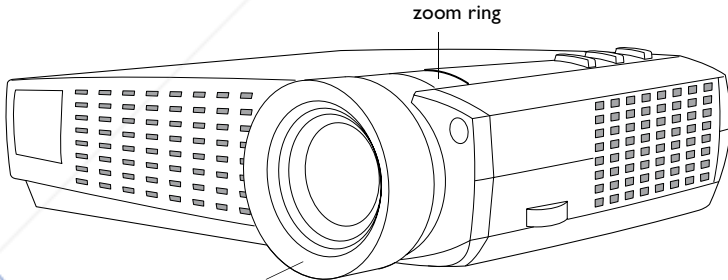

NOTE: To obtain the best overall focus quality, open the menu and focus on the text. This will ensure that the best overall image quality is achieved.

FIGURE 8

Focus ring and zoom ring

The projector is equipped with a self-locking, quick-release elevator foot and button.

To raise the projector:

- 1 Press and hold the elevator button (Figure 9).
- 2 Raise the projector to the height you want, then release the button to lock the elevator foot into position.

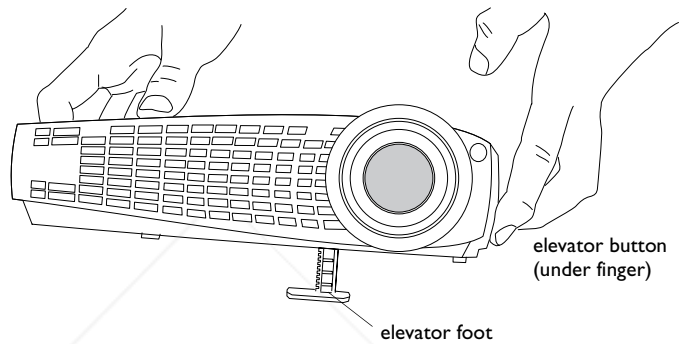

FIGURE 9

Adjusting the height of the projector

Using the Remote Control

To use the forward and back buttons on the remote to advance slides in PowerPoint, you must connect the USB mouse connector on the computer cable to the computer. See page 7 for details.

Point the remote control at the projection screen or at the front of the projector (not at the computer). The range for optimum operation is about 25 feet. If you point the remote at the projection screen, the distance to the screen and back to the projector must be less than or equal to 25 feet. For best results, point the remote directly at the projector.

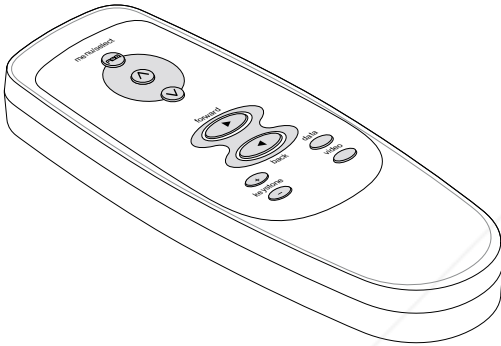

FIGURE 10

Remote control

Using the Keypad and Remote Buttons

While the menus are displayed, the **source** and **reset** buttons on the keypad and the up and down arrow buttons on the remote act as menu navigation and adjustment buttons and the **menu/select** button acts as a select button. See “Using the On-Screen Menus” on page 16 for details.

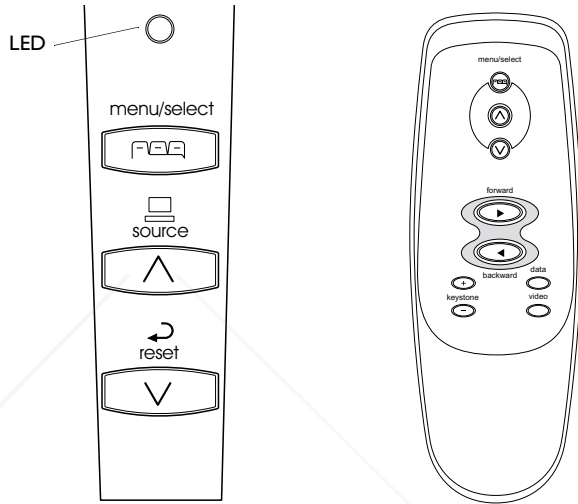

FIGURE 11
Keypad and remote buttons



NOTE: If you have turned Auto Source off (page 22), you may need to press the source button more than once to display an active source. The sources switch in this order: data analog, data digital, S-video, and composite video.

Menu/select

Press the **menu/select** button to open the on-screen menus. Press **menu/select** again (while Exit is highlighted) to close the menus. (The menus automatically close after 30 seconds if no buttons are pressed.) When you close the menus, the projector saves any changes you made. For more information about the on-screen menus, see page 16.

Source (keypad only) or Data and Video (remote only)

When you have more than one source (computer and video) connected to the projector, select between them by pressing the **source** button on the keypad or the **data** or **video** button on the remote.

Reset ↶ (keypad only)

Resets the options in the menus (except Language, Video Standard, and Rear Projection) to their original settings.

Keystone + - (remote only)

Use this feature to adjust the image vertically and make a squarer image.

- Press the **keystone +** button to reduce the upper part of the image, and press the **keystone -** button to reduce the lower part. You can also adjust keystone from the Display menu (see page 17 for details on the menu).

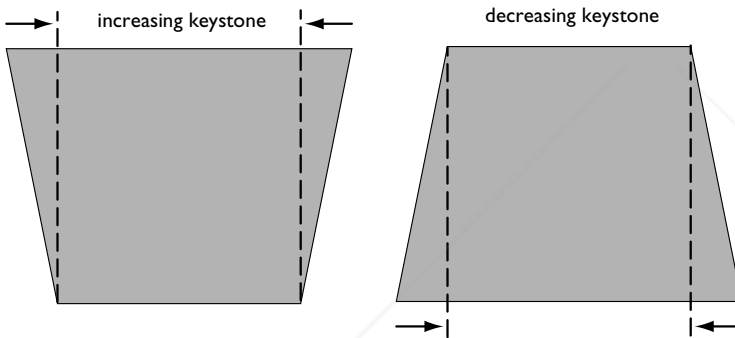

FIGURE 12

Adjusting the keystone

Forward/back buttons (remote only)

These buttons act like the page up and page down buttons on your computer's keyboard. You can use them to advance through a slide show in PowerPoint™ presentations. To use this feature, you must connect the USB mouse connector on the computer cable to your computer. See page 7 for details.

Up/down arrow buttons

Use these buttons to navigate through and make adjustments to the on-screen menus. See "Using the On-Screen Menus" on page 16 for details.



NOTE: Some menu items may be grayed out (dimmed) at certain times. This indicates the item is not applicable to your setup or the item is not enabled until another selection is made.

Using the On-Screen Menus

The projector has menus that allow you to make image adjustments and change a variety of settings. These adjustments aren't available directly from the keypad.

To open the on-screen menus, press the **menu/select** button on the keypad or remote. (The menus automatically close after 30 seconds if no buttons are pressed.) This displays the Main menu and changes the source and reset buttons on the keypad to menu navigation buttons. Press the **∨** button to move the cursor down and press the **∧** button to move the cursor up. The selected menu is highlighted.



FIGURE 13

Main menu

To change a menu setting, use the up and down arrow buttons to move the cursor up and down to the item you want to change (the selected item is highlighted), then press **menu/select**. When an item is selected, its button appears depressed to provide a visual indication of selection. Use the up and down arrows to adjust the setting or turn it on and off. Press **menu/select** when you are done. Press the up and down arrows to move to another setting. When you have completed your adjustments, navigate to Exit, then press **menu/select**. You are returned to the top of the Main menu. Press **menu/select** again to exit the Main menu, or navigate to another submenu.

Display Menu

To access the Display menu settings, press the **menu/select** button to display the Main menu, press the down arrow to highlight Display, then press **menu/select** again to access the Display menu.

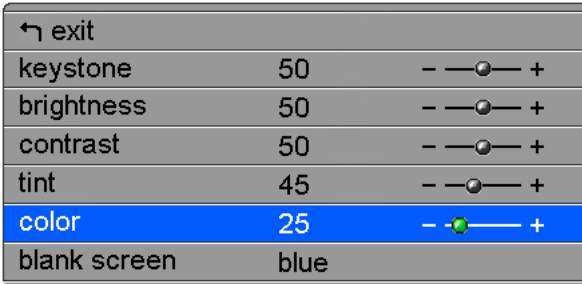

↵ exit		
keystone	50	--●--+
brightness	50	--●--+
contrast	50	--●--+
tint	45	--●--+
color	25	--●--+
blank screen	blue	

FIGURE 14

Display menu

Keystone

This option helps to keep the image square as the angle of projection is changed. Use this feature to adjust the image vertically and make a squarer image. See page 15 for details on keystone adjustments.

- I Press the down button to highlight Keystone, then press **menu/select**. Use the up and down arrows to adjust the keystone setting. Press **menu/select** to accept your changes.

Brightness

Adjusting the brightness changes the intensity of the image.

- I Use the up and down arrows to highlight Brightness, press **menu/select**, use the arrows to adjust the brightness, then press **menu/select** to accept your changes.



NOTE: *The color setting applies to video sources only. The tint setting applies to NTSC video sources only.*

Contrast

The contrast controls the degree of difference between the lightest and darkest parts of the picture. Adjusting the contrast changes the amount of black and white in the image.

- I Use the up and down arrows to highlight Contrast, press **menu/select**, use the arrows to adjust the contrast, then press **menu/select** to accept your changes.

Tint

The tint adjusts the red-green color balance in the projected image.

- I Use the up and down arrows to highlight Tint, press **menu/select**, use the arrows to adjust the tint, then press **menu/select** to accept your changes.

Color

The color setting adjusts a video image from black and white to fully saturated color.

- I Use the up and down arrows to highlight Color, press **menu/select**, use the arrows to adjust the color, then press **menu/select** to accept your changes.

Blank screen

Blank Screen determines what color is displayed when there is no active source and when the projector is in standby.

- I Use the up and down arrows to highlight Blank screen, press **menu/select**, use the arrows to cycle through the options blue, black, and white, then press **menu/select** to accept your selection.



Discount-Merchant.com (800) 281-8860
THE TRUSTED SOURCE FOR PROJECTOR LAMPS AND ACCESSORIES

Image Menu for Computer Sources

To access the Image menu settings, press the **menu/select** button to display the Main menu, press the down arrow to highlight Image, then press **menu/select** again to access the Image menu.

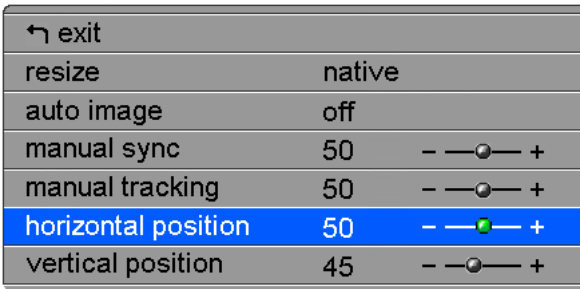

↶ exit		
resize	native	
auto image	off	
manual sync	50	- —●— +
manual tracking	50	- —●— +
horizontal position	50	- —●— +
vertical position	45	- —●— +

FIGURE 15

Image menu for computer sources

Resize

Resize allows you to select from among four different re-sizing options. The default is **Standard**, which resizes the image from its original version to fit a standard 4x3 aspect ratio screen. **Wide-screen Letterbox** preserves the 16x9 aspect ratio of the original theater version, but the image is placed in a 4x3 space, so black bars appear at the top and bottom of the image. **Enhanced Wide-screen** also preserves the aspect ratio of the original theater version and is designed to be used with content that is Enhanced for Widescreen TVs. This option yields more detail than Widescreen Letterbox. **Native** reduces the Standard size to match the height of Enhanced Widescreen.

Highlight **Resize**, press **menu/select**, use the up or down arrow buttons to cycle through the options, then press **menu/select** to select.



The projector automatically adjusts tracking, signal synchronization and vertical and horizontal position for most computers. If you want to adjust these features manually, you must turn off **Auto image** first.

Highlight **Auto image**, press **menu/select**, then press the up or down arrow buttons to turn this feature off and on.

Manual Sync

The projector adjusts signal synchronization automatically for most computers. But if the projected computer image looks fuzzy or streaked, try turning **Auto image** off then back on again. If the image still looks bad, try adjusting the signal synchronization manually:

- 1 Turn Auto Image off.
- 2 Highlight Manual sync, press **menu/select**, use the arrow buttons to adjust Manual sync until the image is sharp and free of streaks, then press **menu/select**.

Manual Tracking

The projector adjusts tracking automatically to match the video signal from your computer. However, if the display shows evenly spaced, fuzzy, vertical lines or if the projected image is too wide or too narrow for the screen, try turning **Auto Image** off then back on again. If the image is still bad, try adjusting the tracking manually:

- 1 Turn Auto image off.
- 2 Highlight Manual tracking, press **menu/select**, use the arrow buttons to adjust Manual tracking until the fuzzy vertical bars are gone, then press **menu/select**.

Horizontal Position

Follow these steps to manually adjust the horizontal position:

- 1 Turn Auto image off.
- 2 Highlight Horizontal position, press **menu/select**, use the arrow buttons to adjust the Horizontal position, then press **menu/select**.

Positioning adjustments are saved when you turn off the projector.

Vertical Position

Follow these steps to manually adjust the vertical position.

- 1 Turn Auto image off.
- 2 Highlight Vertical position, press **menu/select**, use the arrow buttons to adjust the Vertical position, then press **menu/select**.

Positioning adjustments are saved when you turn off the projector.



NOTE: The Manual Sync, Manual Tracking, Horizontal Position and Vertical Position

options are available only for analog computer sources. The projector sets these options automatically for digital computer and video sources, with no manual override.

Image Menu for Video Sources

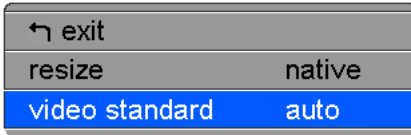

FIGURE 16

Image menu for video sources

Resize

Resize allows you to select from among four different re-sizing options. The default is **Standard**, which resizes the image from its original version to fit a standard 4x3 aspect ratio screen. **Wide-screen Letterbox** preserves the 16x9 aspect ratio of the original theater version, but the image is placed in a 4x3 space, so black bars appear at the top and bottom of the image. **Enhanced Wide-screen** also preserves the aspect ratio of the original theater version and is designed to be used with content that is Enhanced for Widescreen TVs. This option yields more detail than Widescreen Letterbox. **Native** reduces the Standard size to match the height of Enhanced Widescreen.

Highlight **Resize**, press **menu/select**, use the up or down arrows to cycle through the options, then press **menu/select**.

Video Standard (video sources only)

When Video is set to Auto, the projector attempts to pick the video standard (NTSC, NTSC 4.43, PAL, or SECAM) automatically based on the input signal it receives. (The video standard options may vary depending on your region of the world.) If the projector is unable to detect the correct standard, the colors might not look right or the image might appear “torn.” If this happens, manually select a video standard.

Highlight **Video standard**, press **menu/select**, use the up or down arrows to cycle through the options, then press **menu/select** to select.

Control Menu

To access the Control menu settings, press the **menu/select** button to display the Main menu, press the down arrow to highlight Control, then press **menu/select** again to access the Control menu.

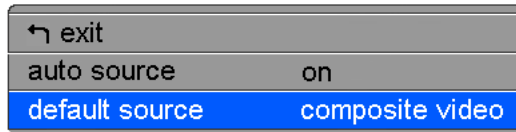

FIGURE 17

Control menu

Auto Source

When this feature is On, the projector automatically finds the active source, checking the default source first. When this feature is Off, the projector defaults to the source selected in Default Source. To display another source, you must manually select one by pressing the **source** button on the keypad or the **data** or **video** button on the remote.

Highlight **Auto source**, press **menu/select**, then press the up or down arrow buttons to turn this feature off and on.

Default Source

This determines which source the projector checks first for active video during power-up. Select among Data-Analog, Data-Digital, composite video, and S-Video.

Highlight **Default source**, press **menu/select**, use the up or down arrows to cycle through the options, then press **menu/select** to select.

Advanced Menu

To access the Advanced menu settings, press the **menu/select** button to display the Main menu, press the down arrow to highlight Advanced, then press **menu/select** again to access the Advanced menu.

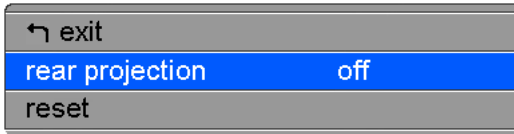

FIGURE 18

Advanced menu

Rear Projection

When you turn **Rear Projection** on, the projector reverses the image so you can project from behind a translucent screen. Highlight **Rear Projection**, press **menu/select**, then press the up or down arrow buttons to turn this feature off and on.

Reset

Highlight Reset then press **menu/select** to reset the options in the menus (except Language, Video Standard, and Rear Projection) to their original settings.

Language Menu



FIGURE 19

Language menu

You can display the on-screen menus in English, French, German, Spanish, Chinese or Japanese.

- 1 Press the **menu/select** button to display the Main menu, press the arrow buttons to highlight Language, then press **menu/select** again to access the Language menu.
- 2 Press the arrow buttons to highlight the desired language, then press **menu/select**. Press **menu/select** to exit this menu and return to the Main menu.

Status Menu

This is a read-only menu for informational purposes. To display the Status menu, highlight Status from the Main menu, then press **menu/select**.

↵ exit	
lamp hours used	39
computer resolution	1024 x 768 at 75Hz
source	data-analog
version	111111

FIGURE 20

Status menu

Lamp hours used

Indicates how many hours the current lamp has been in use. The counter starts at zero hours and counts each hour the lamp is in use. Replace the bulb when the brightness is no longer acceptable. See “Replacing the Projection Lamp” on page 27 for details.

Computer resolution

Shows your computer’s resolution setting. To change this, go to your computer’s Control Panel and adjust the resolution in the Display tab. See your computer’s user’s guide for details.

Source

Indicates the active source, Data-Analog, Data-Digital, Composite video, or S-video.

Version

Indicates the projector’s software version. This information is useful when contacting Technical Support.



Discount-Merchant.com (800) 281-8860
THE TRUSTED SOURCE FOR PROJECTOR LAMPS AND ACCESSORIES



Discount-Merchant.com (800) 281-8860
THE TRUSTED SOURCE FOR PROJECTOR LAMPS AND ACCESSORIES

MAINTENANCE & TROUBLESHOOTING

This section describes how to:

- clean the lens
- replace the projection lamp
- replace the batteries in the remote
- use the security lock feature
- troubleshoot the projector

Cleaning the Lens

Follow these steps to clean the projection lens:

- 1 Apply a non-abrasive camera lens cleaner to a soft, dry cloth.
 - Avoid using an excessive amount of cleaner, and don't apply the cleaner directly to the lens.
 - Abrasive cleaners, solvents or other harsh chemicals might scratch the lens.
- 2 Lightly wipe the cleaning cloth over the lens in a circular motion.
- 3 If you don't intend to use the projector immediately, replace the lens cap.

Replacing the Projection Lamp

The lamp hour counter in the Status menu counts the number of hours the lamp has been in use. Change the lamp when the brightness is no longer acceptable. You can order new lamp modules from Boxlight. See "Accessories" on page 36 for information.

Follow these steps to replace the projection lamp:

- 1 Turn off the projector and unplug the power cord.
- 2 Wait 30 minutes to allow the projector to cool thoroughly.
- 3 Insert a small screwdriver or other flat object into the slot near



WARNING: To avoid burns, allow the projector to cool for at least 30 minutes before you open the lamp access grill. Never extract the lamp module while the projector is operating.



WARNING: Be extremely careful when removing the lamp module. In the unlikely event that the bulb ruptures, small glass fragments may be generated. The lamp module is designed to contain these fragments, but use caution when removing the lamp module.

the front of the projector. Slide the screwdriver toward the back of the projector to disengage the lamp access grill, then slide the lamp access grill off (away from the lens).

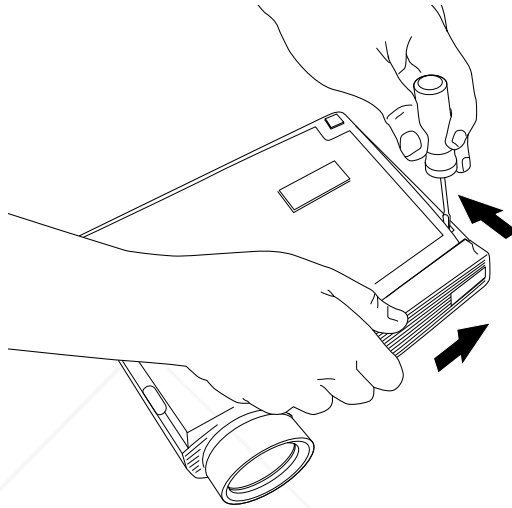

FIGURE 21

Disengaging and removing the lamp access grill



CAUTION: Never operate the projector with the lamp access grill removed. This disrupts the air flow and causes the projector to overheat.

4 Pull the yellow tab on the lamp module.

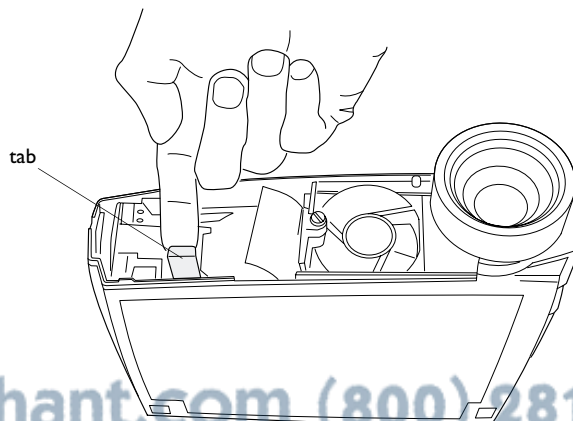

FIGURE 22

Pulling the tab on the lamp module

5 Loosen the captive screw on the lamp module.

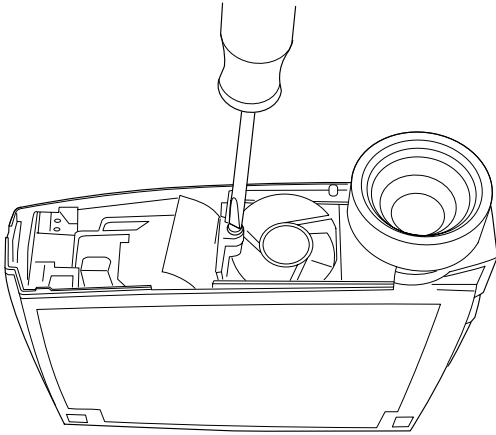

FIGURE 23

Loosening the screw on the lamp module

6 Grasp the pull tab to pull the lamp module out. Dispose of the lamp module in an environmentally proper manner.

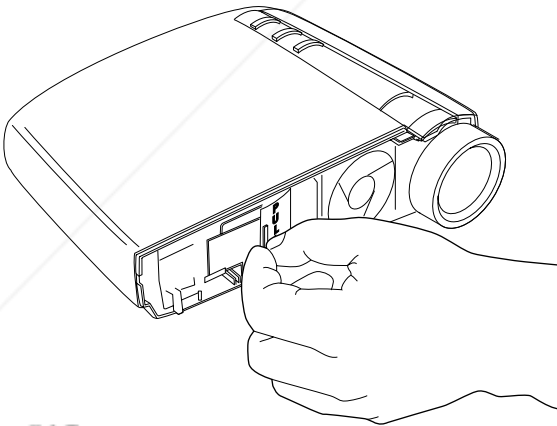

FIGURE 24

Removing the lamp module



WARNING: Do not drop the lamp module or touch the glass bulb! The glass may shatter and cause injury.

- 7 Install the new lamp module.
- 8 Tighten the screw on the outside of the module.
- 9 Press the yellow tab to reconnect the lamp module.
- 10 Replace the lamp access grill by lining up the ribs on the grill with the marks on the bottom case and sliding the grill in the direction of the arrows on the bottom case.
- 11 Plug in the power cord and press the Power switch to turn the projector back on.
- 12 To reset the lamp hour counter in the Status menu, press and hold the **reset** button, then press the **menu/select** button (while still holding down the **reset** button) for 10 seconds. Verify that the counter was reset by pressing the **menu/select** button and viewing the counter in the Status menu. See page 25 for details on the Status menu.



Discount-Merchant.com (800) 281-8860
THE TRUSTED SOURCE FOR PROJECTOR LAMPS AND ACCESSORIES

Replacing the Batteries in the Remote Control

The life of the batteries depends on how often and how long you use the remote. Symptoms of low battery charge include erratic responses when using the remote and a reduced range of operation.

Follow these steps to replace the batteries:

- 1 Turn the remote face down in your hand.
- 2 Push the tab on the battery door toward the top of the remote and lift the door off.
- 3 Remove the old batteries and dispose of them in an environmentally proper manner.
- 4 Install two new AAA alkaline batteries. Make sure you install each in the correct direction.
- 5 Insert the hooks on the battery door into the remote and press the tab to re-install the door.

Using the Security Lock

The projector has a security connector for use with a PC Guardian Cable Lock System (Figure 25). See “Optional Accessories” on page 37 for ordering information. Refer to the information that came with the lock for instructions on how to use it to secure the projector.



NOTE: The lamp cannot be removed while the security lock is attached.

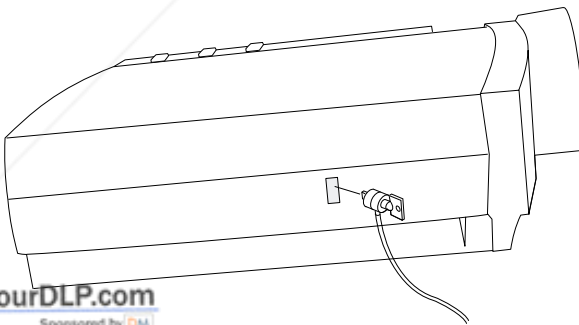

FixYourDLP.com
Sponsored by DM

Discount-Merchant.com (800) 281-8860
Installing the security lock
THE TRUSTED SOURCE FOR PROJECTOR LAMPS AND ACCESSORIES

Troubleshooting

Problem: The projector is not running

- Make sure that the power cord is properly connected to a fully functional AC electrical outlet. Make sure that the power cord is also properly connected to the projector.
- If the projector is plugged into a power strip, make sure the power strip is turned on.
- Make sure the projector is turned on.

Problem: Projector is running, but nothing appears on projection screen

- Make sure you have removed the lens cap on the projection lens at the front of the projector.
- Check the projector's lamp to ensure that it is securely connected in the lamp module. Make sure the lamp access grill is installed. See "Replacing the Projection Lamp" on page 27.

Problem: Only the start-up screen displays

- Verify that the cables are connected correctly. See page 7 for connection procedures.
- Make sure that the cables do not have any bent pins.
- Verify that the proper input source is connected. See "Source (keypad only) or Data and Video (remote only)" on page 14.
- You might need to turn everything off and power up the equipment again in the proper order. Refer to your computer's documentation to determine the correct order.
- Make sure your laptop's external video port is turned on. See the "Portable and Laptop Activation Chart" on page 38 or your computer's manual for details.
- Make sure your computer's video board is installed and configured correctly.
- Make sure your computer has a compatible video board. The projector isn't CGA or EGA compatible.

If you're using Windows 98:

- 1 Open "My Computer" icon, the Control Panel folder and then the Display icon.
- 2 Click the Settings tab.
- 3 Verify that the Desktop area is set to 1280x1024 or less.

Problem: Color or text not being projected

- You might need to adjust the brightness up or down until the text is visible. Refer to "Brightness" on page 17 for more information.

Problem: The screen resolution is not right

- Make sure the computer's video card is set for a resolution of no greater than 1280x1024.

Problem: Image isn't centered on the screen

- Move the projector to reposition the image.
- Reposition the image using the menu. Refer to "Horizontal Position" on page 20 and "Vertical Position" on page 20.
- Be sure the projector is at a 90 degree angle to the screen.

Problem: Image is too wide or narrow for screen

- Adjust the zoom or projector placement.
- Adjust the resolution of your video card if it's greater than 1280x1024.

Problem: Image is out of focus

- Turn the projection lens to focus the image.
- Make sure the projection screen is at least 5 feet (1.5 m) from the projector.
- Check the projection lens to see if it needs cleaning.

Problem: Image and menus are reversed left to right

- Rear projection mode is probably turned on. Turn Rear Projection off in the Controls menu. The image should immediately return to forward projection. See "Rear Projection" on page 23.

Problem: the projector displays vertical lines, “bleeding” or spots

- Adjust the brightness. See “Brightness” on page 17.
- Check the projection lens to see if it needs cleaning.

Problem: Image is “noisy” or streaked

Try these steps in this order.

- 1 Deactivate the screen saver on your computer.
 - 2 Turn **Auto Image** off and then back on again. See “Auto Image” on page 19.
 - 3 Turn **Auto Image** off and adjust the synchronization and tracking manually to find an optimal setting. See “Manual Sync” on page 20 and “Manual Tracking” on page 20.
- The problem could be with your computer’s video card. If possible, connect a different computer.

Problem: Projected colors don’t match the computer or video player’s colors

- Just as there are differences in the displays of different monitors, there are often differences between the computer image and the projected image. Adjust the brightness, tint and/or contrast from the Display menu. See “Brightness” on page 17, “Tint” on page 18 and “Contrast” on page 18.

Problem: Lamp seems to be getting dimmer

- The lamp begins to lose brightness when it has been in use for a long time. Replace the lamp as described in “Replacing the Projection Lamp” on page 27.

Problem: Lamp shuts off

- A minor power surge may cause the lamp to shut off. Unplug the projector, wait at least a minute, then plug it back in.
- Make sure the vents are not blocked.

Before calling Boxlight for assistance, please have the following information available:

- the projector’s serial number (located on the bottom label)
- the resolution of your computer.

Call Boxlight at **1-800-762-5757** or **360-779-7901**

APPENDIX

Specifications

The projector must be operated and stored within the temperature and humidity ranges specified.

Temperature

Operating	50 to 104° F (10 to 40° C) at sea level 50 to 95° F (10 to 35° C) at 10,000 feet
Non-operating	-4 to 158° F (-20 to 70° C)

Altitude

Operating	0 to 10,000 feet (3,048 meters)
Non-operating	0 to 20,000 feet (6,096 meters)

Humidity

Operating and non-oper.	10% to 95% relative humidity, non-condensing
-------------------------	--

Dimensions

6.25 x 8.25 x 2 inches (15.9 x 21.0 x 5.1 cm)

Weight

2.9 lbs. (1.33 kg) unpacked

Optics

Focus Range	4.9 - 13 feet (1.5-4 m)
-------------	-------------------------

Lamp

Type	120-watt UHP lamp
------	-------------------

Input Power Requirements

100-120VAC 2A;50/60Hz

100-240VAC 1A;50/60Hz

Sponsored by 

 Discount-Merchant.com (800) 281-8860
THE TRUSTED SOURCE FOR PROJECTOR LAMPS AND ACCESSORIES

Accessories

Standard Accessories (ship with the projector)

Quick Start card

User's Guide

Soft Case

Shipping Box

Analog Computer Cable 6 ft (1.8 m)

Composite RCA Video Cable 6 ft (1.8 m)

S-video Cable 6 ft (1.8 m)

Remote

Projection Lamp Module (included in projector)

Lens Cap



NOTE: Use only Boxlight-approved accessories. Other products have not been tested with the projector.

Power Cords (one ships with projector, type depends on country)

North American Power Cord

Australian Power Cord

UK Power Cord

European Power Cord

Japanese Power Cord



Discount-Merchant.com (800) 281-8860
THE TRUSTED SOURCE FOR PROJECTOR LAMPS AND ACCESSORIES

Optional Accessories

Deluxe Travel Case
Executive Leather Case
Hard Travel Elite Porter Case
Projection Lamp Module
Digital Computer Cable
Digital/Analog Interface Card
USB Ranger 400 System
Macintosh Adaptor
Executive Plus Remote
Full-Feature LaserPro Remote Control
GyroMouse Pro RF Remote (US, Mexico, Canada, UK only)
Executive Remote IR Receiver
Remote Point RF Remote with LaserPointer (US and Canada only)
GyroMouse Presenter RF Remote Control (US, Mexico, Canada, UK only)
PC Guardian Projector Cable Lock
40" Portable Projection Screen
50" Portable Projection Screen
60" Deluxe Insta-Theatre Screen
Portable Projector Stand
eBeam (Web Enabled Electronic Meeting Assistant)



Discount-Merchant.com (800) 281-8860
THE TRUSTED SOURCE FOR PROJECTOR LAMPS AND ACCESSORIES

Portable and Laptop Activation Chart

Many laptop computers do not automatically turn on their external video port when a projector is connected. Activation commands for some laptop computers are listed in the following table. (If your computer is not listed or the given command does not work, refer to the computer's documentation for the appropriate command.) On many laptops, the activation function key is labeled with an icon, for example  or the text CRT/LCD.



NOTE: Usually, pressing the key commands once activates the external video port, pressing it again activates both the external and internal ports, and pressing it a third time activates the internal port. Refer to your computer's documentation for details on your specific model.

Computer	Key command to activate port	Key command to de-activate port
Acer	Ctrl-Alt-Esc (for setup)	Ctrl-Alt-Esc (for setup)
AST* **	FN-D or Ctrl-D Ctrl-FN-D FN-F5 type from A:/VGA/CRT FN-F12	FN-D or Ctrl-D Ctrl-FN-D FN-F5 type from A:/VGA/CRT FN-F12
AMS	FN-F2	FN-F2
AMT	setup screen	setup screen
AT&T	FN-F3 FN-F6	FN-F3 FN-F6
Advanced Logic Research	Ctrl-Alt-V	Ctrl-Alt-V
Altima	Shift-Ctrl-Alt-C setup VGA/ Conf.Simulscan	Shift-Ctrl-Alt-L setup VGA/ Conf.Simulscan
Ambra**	FN-F12 FN-F5 F2/Choose Option/F5	FN-F12 FN-F5 F2/Choose Option/F5
Amrel* **	setup menu Shift-Ctrl-D	setup menu Shift-Ctrl-D
Apple	see Mac Portable and Mac PowerBook	
Aspen	automatic	automatic
Award	FN-F6	FN-F6
BCC*	automatic	reboot computer

Computer	Key command to activate port	Key command to de-activate port
Bondwell	LCD or CRT options after bootup	reboot for LCD or CRT options to appear
Chaplet**	setup screen FN-F6 FN-F4	setup screen FN-F6 FN-F4
Chembook	FN-F6	FN-F6
Commax	Ctrl-Alt-#6	Ctrl-Alt-#5
Compaq* **	Ctrl-Alt-< FN-F4 automatic mode/? (for setup option)	Ctrl-Alt-> FN-F4 automatic mode/? (for setup option)
Compuadd* **	automatic Alt-F for screen setup option	automatic Alt-F for screen setup option
Data General	Ctrl-Alt-Command	Ctrl-Alt-Command
Data General Walkabout	2 CRT/X at DOS prompt	reboot
Datavue	Ctrl-Shift-M	Ctrl-Shift-M
DEC**	FN-F5 FN-F4	FN-F5 FN-F4
Dell**	Ctrl-Alt-< Ctrl-Alt-F10 FN-F8 (CRT/LCD) FN-D FN-F12	Ctrl-Alt-> Ctrl-Alt-F10 FN-F8 FN-D FN-F12
Digital*	automatic FN-F2	reboot FN-F2
Dolch	dip switch to CRT	dip switch to LCD
Epson	dip switch to CRT	dip switch to LCD
Everex*	setup screen option	setup screen option
For-A	Ctrl-Alt-Shift-C	Ctrl-Shift-Alt-L
Fujitsu	FN-F10	

Computer	Key command to activate port	Key command to de-activate port
Gateway	FN-F3 FN-F1/FN-F1 again simultaneous	FN-F3 FN-F1
Grid* **	FN-F2, choose auto or simultaneous Ctrl-Alt-Tab	FN-F2 Ctrl-Alt-Tab
Hitachi	FN-F7	FN-F7
Honeywell	FN-F10	FN-F10
Hyundai	setup screen option	setup screen option
IBM 970*	automatic	warm reboot
IBM ThinkPad**	reboot, enter setup menu	FN-F2
	FN-F7, select choice from setup menu FN-F1, select choice FN-F5, select choice PS/2 SC select choice (CRT, LCD, etc.)	
Infotel	FN-F12	FN-F12
Kaypro	boot up, monitor plugged in	unplug monitor
Kris Tech	FN-F8	FN-F8
Leading Edge	FN-T	FN-T
Mac Portable 100	no video port: not compatible	
Mac PowerBook		
140, 145, 150, 170	no video port: requires a 3rd-party interface	
160, 165, 180, 520, 540, 5300	Control Panel folder; PowerBook Display folder; Activate Video Mirroring	warm reboot
210, 230, 250, 270, 280, 2300	requires Apple Docking Station or Mini Dock	
Magitronic	FN-F4	FN-F4
Mastersport	FN-F2	FN-F1



Discount-Merchant.com (800) 281-8860
 THE TRUSTED SOURCE FOR PROJECTOR LAMPS AND ACCESSORIES

Computer	Key command to activate port	Key command to de-activate port
Micro Express*	automatic	warm reboot
Micron	FN-F2	FN-F2
Microslate*	automatic	warm reboot
Mitsubishi	SW2 On-Off-Off-Off	SW2 Off-On-On-On
NCR	setup screen option	setup screen option
NEC* **	setup screen option CRT at the DOS prompt FN-F3	setup screen option LCD at the DOS prompt FN-F3
Olivetti*	automatic FN-O/*	automatic FN-O/*
Packard Bell* **	FN-F0 Ctrl-Alt-<	FN-F0 Ctrl-Alt->
Panasonic	FN-F2	FN-F2
Prostar	Ctrl-Alt-S at bootup	Ctrl-Alt-S at bootup
Samsung*	setup screen option	setup screen option
Sanyo	setup screen option	setup screen option
Sharp	dip switch to CRT	dip switch to LCD
Sun SPARC-Dataview	Ctrl-Shift-M	Ctrl-Shift-M
Tandy**	Ctrl-Alt-Insert setup screen option	Ctrl-Alt-Insert setup screen option
Tangent	FN-F5	FN-F5
Texas Instruments*	setup screen option	setup screen option
Top-Link* **	setup screen option FN-F6	setup screen option FN-F6
Toshiba* **	Ctrl-Alt-End FN-End FN-F5	Ctrl-Alt-Home FN-Home FN-F5
Twinhead*	FN-F7 FN-F5 Automatic	FN-F7 FN-F5 Automatic
WinBook	Ctrl-Alt-F10	Ctrl-Alt-F10



FixYourDLP.com

Sponsored by DM

DiscountMerchant.com (800) 281-8860
 THE TRUSTED SOURCE FOR PROJECTOR LAMPS AND ACCESSORIES

Computer	Key command to activate port	Key command to de-activate port
Wyse	software driven	software driven
Zenith**	FN-F10	FN-F10
	FN-F2	FN-F2
	FN-F1	FN-F1
Zeos**	Ctrl-Shift-D	Ctrl-Shift-D
	FN-F1	FN-F1

* These manufacturers have models that automatically send video to the external CRT port when some type of display device is attached.

** These manufacturers offer more than one key command depending on the computer model.



Discount-Merchant.com (800) 281-8860
THE TRUSTED SOURCE FOR PROJECTOR LAMPS AND ACCESSORIES

Using Video Mirroring with a PowerBook Computer

When you turn video mirroring (called SimulScan in newer PowerBooks—see below) on, the projector displays the same information that appears on your PowerBook's built-in screen. When video mirroring is off, the projector acts like a separate display.

To turn on video mirroring for the first time:

- 1 Open the Monitors control panel; click on Monitor 2.
- 2 Set the number of colors you want.
- 3 Open the Control Strip, then click on the monitor icon.
- 4 Select "Turn Video Mirroring On."

Now you can turn video mirroring on and off from the Control Strip without having to open the Monitors control panel again.

When using video mirroring and high color graphics such as slide shows, the projected image occasionally might turn black and white. If this happens, perform the following steps:

- 1 Turn off video mirroring.
- 2 Open the Monitors control panel.
- 3 Move the white menu bar to Monitor 2 to set the projector as the primary monitor.
- 4 Restart the PowerBook.

Using SimulScan

Some newer PowerBooks display images on an external monitor or projector differently than previous ones. When using SimulScan, the projector displays the same information that appears on your PowerBook

To select SimulScan:

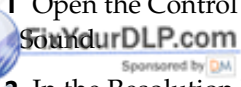
- 1 Open the Control Panel, then double-click Monitors and  Sponsored by DM
- 2 In the Resolution list, choose the SimulScan mode, then click OK.
- 3 If this changes your display settings, a dialog box appears. Click OK to confirm the change.

Discount-Merchant.com (800) 281-8860
THE TRUSTED SOURCE FOR PROJECTOR LAMPS AND ACCESSORIES



Projected Image Size

NOTE: Use the graph and table to help you determine projected image sizes.

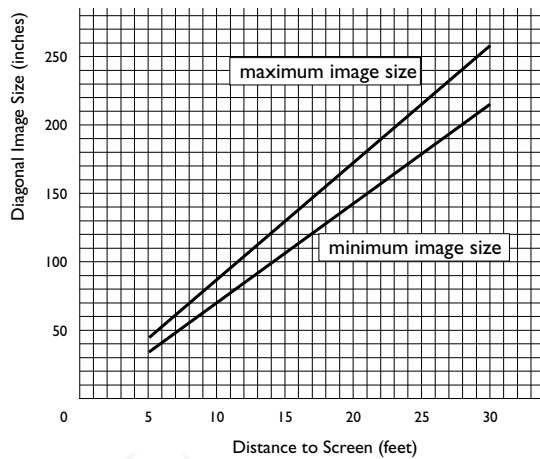

FIGURE 26
Projected image size

Table 1:
Range of distance to the screen for a given screen size

Diagonal Screen Size (inches)	Image Width (inches)	Distance to screen	
		Maximum distance (feet)	Minimum Distance (feet)
60	48	8.5	6.9
72	58	10.2	8.3
84	67	11.9	9.7
90	72	12.7	10.4
100	80	14.1	11.6
120	96	17.0	13.9
150	120	21.2	17.4



Discount-Merchant.com (800) 281-8860
THE TRUSTED SOURCE FOR PROJECTOR LAMPS AND ACCESSORIES

INDEX

A

- accessories, ordering 36, 37
- activation commands for laptop computers 38
- adjusting
 - brightness 17
 - color 18
 - contrast 18
 - height of the projector 12
 - keystone 17
 - tint 18
- Advanced menu options
 - Rear projection 23
 - Reset 23
- altitude limits 35
- assistance. See Technical Support
- auto image 19
- auto source 22

B

- brightness, adjusting 17
- buttons on keypad
 - Menu/select 14
 - Reset 15
 - Source 14

C

- cables
 - computer cable 2, 6, 7
 - ordering 36
 - power 36
 - video 8
- cases, ordering 36
- centering the image 12, 20
- cleaning the projection lens 27
- color, adjusting 18
- colors
 - don't match monitor colors 34
 - not displayed 33
- compatibility
 - IBM-compatible 1
 - Macintosh 1
- computer cable 2, 6, 7
- computers
 - compatible 1
 - connecting 7
- connecting
 - computer 7
 - power cord 9
 - video player 8
- contrast, adjusting 18
- Control menu options
 - Auto source 22
 - Default Source 22

D

- Default Source 22
- Display menu options
 - Blank screen 18
 - Brightness 17
 - Color 18
 - Contrast 18
 - Keystone 17
 - Tint 18
- displaying on-screen menus 14



Discount-Merchant.com (800) 281-8860
THE TRUSTED SOURCE FOR PROJECTOR LAMPS AND ACCESSORIES

E

elevator button/foot 12

F

focusing the image 11
 forward/back buttons 15
 fuzzy lines 20

H

HDTV 1, 8, 18
 height adjustment 12

I

IBM-compatible computers
 compatibility 1
 connecting 7
 image
 adjusting 9, 11
 centering 20
 colors don't match computer's 34
 focusing 11
 fuzzy lines 20
 has lines or spots 34
 not centered 33
 not displayed 32
 out of focus 33
 quality 33–34
 resolution 1
 reversed 23, 33
 size 5, 44
 streaked 34
 too wide or too narrow 33
 zooming 11

Image menu options

 Auto Image 19
 Horiz. Position 20
 Manual Sync 20
 Manual Tracking 20
 Resize 19
 Vert. Position 20
 Video Standard 21

K

keypad 14
 keystone adjustment 15

L

lamp
 ordering 36, 37
 replacing 27
 turns off unexpectedly 34
 lamp hour counter 25, 27, 30
 Language menu 24
 language, selecting for menus 24
 laptop computers
 activation sequence to allow
 secondary display 38
 compatibility 7
 connecting 7
 LED 9, 14
 lens
 cap 36
 cleaning 27

M

Macintosh computers
 compatibility 1
 connecting 6
 maintenance 27
 menus. See on-screen menus
 monitor, projected colors don't match
 34

N

NTSC video 21

O

on-screen menus
 changing language of 24
 displaying 16



P

- PAL video 21
- power cord
 - connecting 9
 - ordering 36
- power up sequence 9, 32
- PowerPoint slides, advancing 15
- project from behind the screen 23
- projector
 - cases 36
 - project from behind the screen 23
 - setting up 5
 - specifications 35
 - turning off 9
 - turning on 9

R

- rear projection 23
- remote control
 - advancing PowerPoint slides with 15
 - replacing the batteries 31
 - using 13, 14
- replacing projection lamp module 27
- re-positioning the image on the screen 20
- Reset button 15
- resetting adjustments 15, 23
- resetting the lamp hour counter 30
- resizing the image 19
- resolution 1

S

- safety guidelines iii
- security lock 31, 37
- shutting off the projector 9
- SimulScan, using with PowerBooks 43
- Source button 14
- specifications 35
- starting up the projector 9
- Status menu 25
- S-video, connecting 8

T

- Technical Support
 - information to have on hand before you call 34
- temperature limits 35
- text not visible 33
- tint, adjusting 18
- troubleshooting 32
- turning off the projector 9
- turning on the projector 9

V

- vertical lines displayed 20, 34
- video cable, connecting 8
- video mirroring on a PowerBook 43
- video resize 21
- video standard 21

W

- widescreen video 19, 21

Z

- zooming the image 11



Discount-Merchant.com (800) 281-8860
THE TRUSTED SOURCE FOR PROJECTOR LAMPS AND ACCESSORIES



Discount-Merchant.com (800) 281-8860
THE TRUSTED SOURCE FOR PROJECTOR LAMPS AND ACCESSORIES

LIMITED WARRANTY

Boxlight ("Boxlight") warrants that each XD-10m ("the Product") sold hereunder will conform to and function in accordance with the written specifications of Boxlight. Said limited warranty shall apply only to the first person or entity that purchases the Product for personal or business use and not for the purpose of distribution or resale. Said warranty shall continue for a period of two (2) years from the date of such purchase. The standard limited warranty excludes the lamps in projectors after 120 days and the accessories after one year. Boxlight does not warrant that the Product will meet the specific requirements of the first person or entity that purchases the Product for personal or business use. Boxlight's liability for the breach of the foregoing limited warranty is limited to the repair or replacement of the Product or refund of the purchase price of the Product, at Boxlight's sole option. Replacement Product may be re-furbished in "like-new" condition, at Boxlight's sole discretion. To exercise the Purchaser's rights under the foregoing warranty, the Product must be returned at the Purchaser's sole cost and expense, to Boxlight or to any authorized Boxlight service center provided, and the Product must be accompanied by a written letter explaining the problem and which includes (i) proof of date of purchase; (ii) the dealer's name; and (iii) the model and serial number of the Product. When sending your unit in for repair, please ship your unit in its original packing material or a Boxlight approved ATA Shipping Case, or have a professional packaging company pack the unit. Please insure your shipment for its full value. A return authorization number, issued by the Boxlight customer service department, must also be clearly displayed on the outside of the shipping carton containing the Product.

WARRANTY LIMITATION AND EXCLUSION

Boxlight shall have no further obligation under the foregoing limited warranty if the Product has been damaged due to abuse, misuse, neglect, accident, unusual physical or electrical stress, unauthorized modifications, tampering, alterations, or service other than by Boxlight or its authorized agents, causes other than from ordinary use or failure to properly use the Product in the application for which said Product is intended.

DISCLAIMER OF UNSTATED WARRANTIES

THE WARRANTY PRINTED ABOVE IS THE ONLY WARRANTY APPLICABLE TO THIS PURCHASE. ALL OTHER WARRANTIES, EXPRESS OR IMPLIED, INCLUDING, BUT NOT LIMITED TO, THE IMPLIED WARRANTIES OF MERCHANTABILITY AND FITNESS FOR A PARTICULAR PURPOSE ARE DISCLAIMED. THERE ARE NO WARRANTIES THAT EXTEND BEYOND THE FACE HEREOF AND THE FOREGOING WARRANTY SHALL NOT BE EXTENDED, ALTERED OR VARIED EXCEPT BY WRITTEN INSTRUMENT SIGNED BY BOXLIGHT. SOME STATES DO NOT ALLOW LIMITATIONS ON HOW LONG AN IMPLIED WARRANTY MAY LAST, SO SUCH LIMITATIONS MAY NOT APPLY TO YOU.

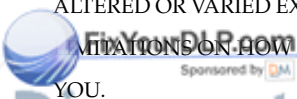

Discount-Merchant.com (800) 281-8860
THE TRUSTED SOURCE FOR PROJECTOR LAMPS AND ACCESSORIES

LIMITATION OF LIABILITY

IT IS UNDERSTOOD AND AGREED THAT BOXLIGHT'S LIABILITY WHETHER IN CONTRACT, IN TORT, UNDER ANY WARRANTY, IN NEGLIGENCE OR OTHERWISE SHALL NOT EXCEED THE RETURN OF THE AMOUNT OF THE PURCHASE PRICE PAID BY PURCHASER AND UNDER NO CIRCUMSTANCES SHALL BOXLIGHT BE LIABLE FOR SPECIAL, INDIRECT, INCIDENTAL OR CONSEQUENTIAL DAMAGES OR LOST PROFITS, LOST REVENUES OR LOST SAVINGS. THE PRICE STATED FOR THE PRODUCT IS A CONSIDERATION IN LIMITING BOXLIGHT'S LIABILITY. NO ACTION, REGARDLESS OF FORM, ARISING OUT OF THE AGREEMENT TO PURCHASE THE PRODUCT MAY BE BROUGHT BY PURCHASER MORE THAN ONE YEAR AFTER THE CAUSE OF ACTION HAS ACCRUED. SOME STATES DO NOT ALLOW THE EXCLUSION OR LIMITATION OF INCIDENTAL OR CONSEQUENTIAL DAMAGES SO THE ABOVE LIMITATION OR EXCLUSION MAY NOT APPLY TO YOU. THIS LIMITED WARRANTY GIVES YOU SPECIFIC LEGAL RIGHTS, AND YOU MAY ALSO HAVE OTHER RIGHTS WHICH VARY FROM STATE TO STATE.



Discount-Merchant.com (800) 281-8860
THE TRUSTED SOURCE FOR PROJECTOR LAMPS AND ACCESSORIES

Part Number 010-0270-00



Disclaimer

This user manual is provided as a free service by FixYourDLP.com. FixYourDLP is in no way responsible for the content of this manual, nor do we guarantee its accuracy. FixYourDLP does not make any claim of copyright and all copyrights remain the property of their respective owners.

About FixYourDLP.com

FixYourDLP.com (<http://www.fixyourdlp.com>) is the World's #1 resource for media product news, reviews, do-it-yourself guides, and manuals.

Informational Blog: <http://www.fixyourdlp.com>

Video Guides: <http://www.fixyourdlp.com/guides>

User Forums: <http://www.fixyourdlp.com/forum>

FixYourDLP's Fight Against Counterfeit Lamps:

<http://www.fixyourdlp.com/counterfeits>

Sponsors:

RecycleYourLamp.org – Free lamp recycling services for used lamps:

<http://www.recycleyourlamp.org>

Lamp Research - The trusted 3rd party lamp research company:

<http://www.lampresearch.com>

Discount-Merchant.com – The worlds largest lamp distributor:

<http://www.discount-merchant.com>



FixYourDLP.com

Sponsored by 