



# Disclaimer

This user manual is provided as a free service by FixYourDLP.com. FixYourDLP is in no way responsible for the content of this manual, nor do we guarantee its accuracy. FixYourDLP does not make any claim of copyright and all copyrights remain the property of their respective owners.

About FixYourDLP.com

FixYourDLP.com (<http://www.fixyourdpl.com>) is the World's #1 resource for media product news, reviews, do-it-yourself guides, and manuals.

Informational Blog: <http://www.fixyourdpl.com>

Video Guides: <http://www.fixyourdpl.com/guides>

User Forums: <http://www.fixyourdpl.com/forum>

FixYourDLP's Fight Against Counterfeit Lamps:

<http://www.fixyourdpl.com/counterfeits>

## Sponsors:

RecycleYourLamp.org – Free lamp recycling services for used lamps:

<http://www.recycleyourlamp.org>

Lamp Research - The trusted 3rd party lamp research company:

<http://www.lampresearch.com>

Discount-Merchant.com – The worlds largest lamp distributor:

<http://www.discount-merchant.com>



**FixYourDLP.com**

Sponsored by 

# Data Projector



## Operating Instructions

Before operating the unit, please read this manual thoroughly and retain it for future reference.

VPL-EX70

VPL-EX7

VPL-ES7

# WARNING

**To reduce the risk of fire or electric shock, do not expose this apparatus to rain or moisture.**

**To avoid electrical shock, do not open the cabinet. Refer servicing to qualified personnel only.**

## WARNING

**THIS APPARATUS MUST BE EARTHED.**

## IMPORTANT

The nameplate is located on the bottom.

## WARNING

When installing the unit, incorporate a readily accessible disconnect device in the fixed wiring, or connect the power plug to an easily accessible socket-outlet near the unit. If a fault should occur during operation of the unit, operate the disconnect device to switch the power supply off, or disconnect the power plug.

## CAUTION

Danger of explosion if battery is incorrectly replaced.

Replace only with the same or equivalent type recommended by the manufacturer. When you dispose of the battery, you must obey the law in the relative area or country.

## For the customers in the U.S.A.

This equipment has been tested and found to comply with the limits for a Class B digital device, pursuant to Part 15 of the FCC Rules. These limits are designed to provide reasonable protection against harmful interference to residential installation. This equipment generates, uses, and can radiate radio frequency energy and, if not installed and used in accordance with the instructions, may cause harmful interference to radio communications. However, there is no guarantee that interference will not occur in a particular installation. If this equipment does cause harmful interference to radio or television reception, which can be

determined by turning the equipment off and on, the user is encouraged to try to correct the interference by one or more of the following measures:

- Reorient or relocate the receiving antenna.
- Increase the separation between the equipment and receiver.
- Connect the equipment into an outlet on a circuit different from that to which the receiver is connected.
- Consult the dealer or an experienced radio/TV technician for help.

You are cautioned that any changes or modifications not expressly approved in this manual could void your authority to operate this equipment.

All interface cables used to connect peripherals must be shielded in order to comply with the limits for a digital device pursuant to Subpart B of Part 15 of FCC Rules.

If you have any questions about this product, you may call:

Sony Customer Information Service Center  
1-800-222-7669 or <http://www.sony.com/>

## Declaration of Conformity

Trade Name: SONY  
Model: VPL-EX70, VPL-EX7, VPL-ES7  
Responsible Party: Sony Electronics Inc.  
Address: 16530 Via Esprillo,  
San Diego, CA 92127 U.S.A.  
Telephone Number: 858-942-2230

This device complies with part 15 of the FCC Rules. Operation is subject to the following two conditions: (1) this device may not cause harmful interference, and (2) this device must accept any interference received, including interference that may cause undesired operation.

**WARNING: THIS WARNING IS APPLICABLE FOR USA ONLY.**  
If used in USA, use the UL LISTED power cord specified below.  
**DO NOT USE ANY OTHER POWER CORD.**

Plug Cap	Parallel blade with ground pin (NEMA 5-15P Configuration)
Cord	Type SJT, three 16 or 18 AWG wires
Length	Minimum 1.5m (4 ft .11 in.), Less than 4.5 m (14 ft .9 <sup>5</sup> / <sub>8</sub> in.)
Rating	Minimum 10A, 125V

Using this unit at a voltage other than 120V may require the use of a different line cord or attachment plug, or both.

To reduce the risk of fire or electric shock, refer servicing to qualified service personnel.

**WARNING: THIS WARNING IS APPLICABLE FOR OTHER COUNTRIES.**

1. Use the approved Power Cord (3-core mains lead) / Appliance Connector / Plug with earthing-contacts that conforms to the safety regulations of each country if applicable.
2. Use the Power Cord (3-core mains lead) / Appliance Connector / Plug conforming to the proper ratings (Voltage, Ampere).

If you have questions on the use of the above Power Cord /Appliance Connector /Plug, please consult a qualified service personnel.

**For the customers in Europe**

The manufacturer of this product is Sony Corporation, 1-7-1 Konan, Minato-ku, Tokyo, Japan.

The Authorized Representative for EMC and product safety is Sony Deutschland GmbH, Hedelfinger Strasse 61, 70327 Stuttgart, Germany. For any service or guarantee matters please refer to the addresses given in separate service or guarantee documents.

**For the State of California, USA only**

Perchlorate Material - special handling may apply. See

[www.dtsc.ca.gov/hazardouswaste/perchlorate](http://www.dtsc.ca.gov/hazardouswaste/perchlorate)

Perchlorate Material: Lithium battery contains perchlorate.

**Disposal of the used lamp**

**For the customers in the USA**

Lamp in this product contains mercury. Disposal of these materials may be regulated due to environmental considerations. For disposal or recycling information, please contact your local authorities or the Electronic Industries Alliance ([www.eiae.org](http://www.eiae.org)).

**Disposal of Old Electrical & Electronic Equipment (Applicable in the European Union and other European countries with separate collection systems)**



This symbol on the product or on its packaging indicates that this product shall not be treated as household waste. Instead it shall be handed over to the applicable collection point for the recycling of electrical and

electronic equipment. By ensuring this product is disposed of correctly, you will help prevent potential negative consequences for the environment and human health, which could otherwise be caused by inappropriate waste handling of this product. The recycling of materials will help to conserve natural resources. For more detailed information about recycling of this product, please contact your local city office, your household waste disposal service or the shop where you purchased the product.

**For the customers in Taiwan only**



廢電池請回收

**For kundene i Norge**

Dette utstyret kan kobles til et IT-strømfordelingssystem.

---

# Table of Contents

Precautions ..... 5  
Notes on Installation and Usage ..... 6

---

## Overview

Features ..... 9  
Location and Function of Controls .. 10  
    Top/Right Side/Front ..... 10  
    Rear/Bottom ..... 10  
    Control Panel ..... 12  
    Connector Panel ..... 14  
    Remote Commander ..... 15

---

## Projecting the Picture

Installing the Projector ..... 17  
Connecting the Projector ..... 18  
    Connecting a Computer ..... 18  
    Connecting a VCR ..... 19  
Projecting ..... 20  
Turning Off the Power ..... 22

---

## Convenient Functions

Selecting the Menu Language ..... 23  
Security Lock ..... 24  
Other Functions ..... 25  
    Direct Power On/Off Function ... 25  
    Off & Go Function ..... 25  
    Effective Tools for Your  
    Presentation ..... 25

---

## Adjustments and Settings Using a Menu

Using a MENU ..... 27  
The PICTURE SETTING Menu ..... 29  
The INPUT SETTING Menu ..... 31

About the Preset Memory No. ....32  
The SET SETTING Menu .....33  
The MENU SETTING Menu .....35  
The INSTALL SETTING Menu .....36  
The INFORMATION Menu .....38

---

## Maintenance

Replacing the Lamp .....40  
Cleaning the Air Filter .....42

---

## Others

Troubleshooting .....43  
    Messages List .....45  
Specifications .....47  
Installation Diagram .....52  
    Floor Installation (Front  
    Projection) .....52  
    Ceiling Installation (Front  
    Projection) .....54  
Dimensions .....56  
Index .....58



FixYourDiscount.com  
Sponsored by DM

Discount Merchant.com (800) 281-8860  
THE TRUSTED SOURCE FOR PROJECTOR LAMPS AND ACCESSORIES

---

# Precautions

---

## Safety

- Check that the operating voltage of your unit is identical with the voltage of your local power supply. If voltage adaptation is required, consult with qualified Sony personnel.
- Should any liquid or solid object fall into the cabinet, unplug the unit and have it checked by qualified personnel before operating it further.
- Unplug the unit from the wall outlet if it is not to be used for several days.
- To disconnect the cord, pull it out by the plug. Never pull the cord itself.
- The wall outlet should be near the unit and easily accessible.
- The unit is not disconnected to the AC power source (mains) as long as it is connected to the wall outlet, even if the unit itself has been turned off.
- Do not look into the lens while the lamp is on.
- Do not place your hand or objects near the ventilation holes. The air coming out is hot.
- Be careful not to get your fingers caught in the adjuster.
- Do not spread a cloth or paper under the unit.

---

## Illumination

- To obtain the best picture, the front of the screen should not be exposed to direct lighting or sunlight.
- Ceiling-mounted spot lighting is recommended. Use a cover over fluorescent lamps to avoid lowering the contrast ratio.
- Cover any windows that face the screen with opaque draperies.
- It is desirable to install the unit in a room where floor and walls are not of light reflecting material. If the floor and walls are of reflecting material, it is recommended that the carpet and wall paper be changed to a dark color.

---

## Preventing internal heat build-up

The unit is equipped with ventilation holes (intake) and ventilation holes (exhaust). Do not block or place anything near these holes, or internal heat build-up may occur, causing picture degradation or damage to the projector.

---

## Cleaning

### Before cleaning

Be sure to disconnect the AC power cord from the AC outlet.

### Cleaning the air filter

- Clean the air filter whenever you replace the lamp.
- Refer to the “Cleaning the Air Filter” on page 42 for the air filter cleaning.

### Cleaning the lens

The lens surface is especially treated to reduce reflection of light.

As incorrect maintenance may impair the performance of the projector, take care with respect to the following:

- Avoid touching the lens. To remove dust on the lens, use a soft dry cloth. Do not use a damp cloth, detergent solution, or thinner.
- Wipe the lens gently with a soft cloth such as a cleaning cloth or glass cleaning cloth.
- Stubborn stains may be removed with a soft cloth such as a cleaning cloth or glass cleaning cloth lightly dampened with water.
- Never use solvent such as alcohol, benzene or thinner, or acid, alkaline or abrasive detergent, or chemical cleaning cloth, as they will damage the lens surface.

### Cleaning the cabinet

- Clean the cabinet gently with a soft dry cloth. Stubborn stains may be removed with a cloth lightly dampened with mild detergent solution, followed by wiping with a soft dry cloth.
- Use of alcohol, benzene, thinner or insecticide may damage the finish of the cabinet or remove the indications on the cabinet. Do not use these chemicals.



FixProjector.com

Discontinued Projector Lamps and Accessories 1-860-860-860

THE TRUSTED SOURCE FOR PROJECTOR LAMPS AND ACCESSORIES

- If you rub on the cabinet with a stained cloth, the cabinet may be scratched.
- If the cabinet is in contact with a rubber or vinyl resin product for a long period of time, the finish of the cabinet may deteriorate or the coating may come off.

### LCD data projector

This LCD data projector is manufactured using high-precision technology. You may, however, see tiny black points and/or bright points (red, blue, or green) that appear continuously on the LCD data projector. This is a normal result of the manufacturing process and does not indicate a malfunction. When the images are projected onto the screens from multiple LCD data projectors, they may generate color distinctions because each projector has its own color balance even if the projectors are the same models.

## Notes on Installation and Usage

### Unsuitable Installation

Do not install the projector in the following situations. **Installation in these situations or locations may cause a malfunction or damage** to the unit.

### Poorly ventilated locations

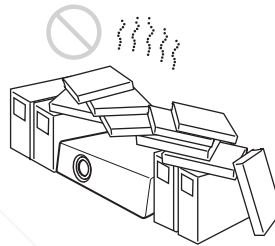

- Allow adequate air circulation to prevent internal heat build-up. Do not place the unit on surfaces (rugs, blankets, etc.) or near materials (curtains, draperies) that may block the ventilation holes. When internal heat builds up due to blockage of ventilation holes, the temperature sensor will function, and the power will be turned off automatically.
- Leave space of more than 30 cm (11 <sup>7</sup>/<sub>8</sub> inches) around the unit.
- Be careful not to allow the ventilation holes to inhale tiny objects such as pieces of paper or clumps of dust.



**Discount-Merchant.com (800) 281-8860**  
**THE TRUSTED SOURCE FOR PROJECTOR LAMPS AND ACCESSORIES**

---

## Hot and humid

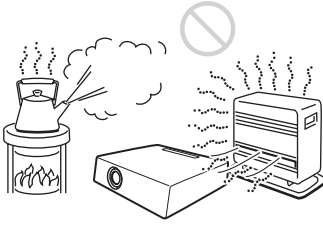

- Avoid installing the unit in a location where the temperature or humidity is very high, or the temperature is very low.
- To avoid moisture condensation, do not install the unit in a location where the temperature may rise rapidly.

---

## Locations subject to direct cool or warm air from an air-conditioner

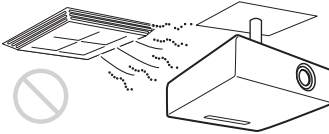

Installing the projector in such a location may cause a malfunction of the unit due to moisture condensation or a rise in temperature.

---

## Near a heat or smoke sensor

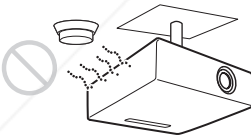

Malfunction of the sensor may occur.

---

## Very dusty, extremely smoky locations

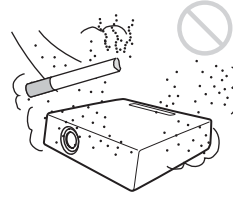

Avoid installing the unit in a very dusty or extremely smoky environment. Otherwise, the air filter will become obstructed, and this may cause a malfunction of the unit or damage it. Dust preventing the air passing through the filter may cause a rise in the internal temperature of the unit. Clean the air filter whenever you replace the lamp.

---

## Unsuitable Conditions

Do not use the projector under the following conditions.

---

### Do not stand the unit upright on one side

Avoid using the unit standing upright on its side. It may cause malfunction.

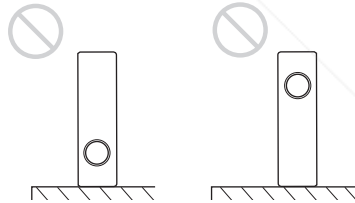

---

### Do not tilt the unit to the right or left

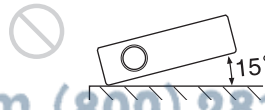

Avoid tilting the unit to an angle of 15°, and avoid installing the unit in any way other than placing it on a level surface or suspending from the ceiling. Such an installation may cause color shading or shorten the lamp life excessively.



---

## Do not block the ventilation holes

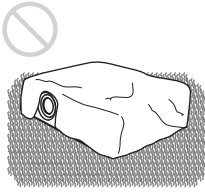

Avoid using a thick-piled carpet or anything that covers the ventilation holes (exhaust/intake); otherwise, internal heat may build up.

---

## Do not place a blocking object just in front of the lens

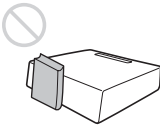

Do not place any object just in front of the lens that may block the light during projection. Heat from the light may damage the object. Use the PIC MUTING key to cut off the picture.

---

## Do not use the Security bar for transporting or installation

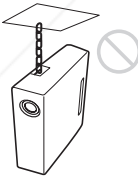

Use the Security bar at the rear of the projector for a purpose of preventing theft, by attaching a commercially available theft prevention cable, for example. If you lift the projector by holding the Security bar, or hang the projector by using this bar, it may cause the projector to fall or be damaged.

## Usage at High Altitude

When using the projector at an altitude of 1,500 m or higher, turn on “High Altitude Mode” in the INSTALL SETTING menu. Failing to set this mode when using the projector at high altitudes could have adverse effects, such as reducing the reliability of certain components.

## Notes on Use

### Note on carrying the projector

The unit is manufactured using high-precision technology. When transporting the unit stored in the carrying case, do not drop the unit or subject it to shock, as this may cause damage. When storing the unit in the carrying case, disconnect the AC power cord and all other connecting cables or cards, and store the supplied accessories in a pocket of the carrying case.

### Note on the screen

When using a screen with an uneven surface, a striped pattern may rarely appear on the screen depending on the distance between the screen and the projector or the zooming magnification settings used. This is not a malfunction of the projector.

---

# Features

---

## High brightness · High picture performance

### High brightness

Sony's unique optical system allows high efficiency.

### High picture performance

**VPL-EX70/EX7:** Three super-high-aperture 0.63-inch XGA panels with approximately 790,000 effective pixels produce a resolution of 1024 × 768 dots (horizontal/vertical) for RGB input, and 750 horizontal TV lines for video input.

**VPL-ES7:** Three super-high-aperture 0.63-inch SVGA panels with approximately 480,000 effective pixels produce a resolution of 800 × 600 dots (horizontal/vertical) for RGB input, and 500 horizontal TV lines for video input.

---

## Direct Power On/Power Off function

The AC power for the entire system can be turned on and off by means of a breaker or other switch without going through a standby mode.

---

## Simple maintenance

Even when the projector is mounted on the ceiling, you can clean the air filter easily because it is located at the side. Clean the filter at the same time as you replace the lamp.

---

## Short focal lens

The projection distance is very short, approximately 2.4 m (7.9 feet), when projecting an 80-inch image, which allows projection on a larger screen even in a limited space.

---

## Security Functions

### Security lock

This function makes it possible to prevent projection of a picture on the screen unless the required password is entered when the projector is turned on.

## Panel key lock

This function locks all the keys on the control panel of the projector, allowing use of the keys on the Remote Commander. This prevents the projector from operating incorrectly.

---

## Other Convenient Functions

- On-screen menu in 17 languages
- Picture muting
- Freeze
- Lamp mode switching function
- Low power consumption in standby
- Security bar

---

## About Trademarks

- Adobe Acrobat is a trademark of Adobe Systems Incorporated.
- Windows is a registered trademark of Microsoft Corporation in the United States and/or other countries.
- Kensington is a registered trademark of Kensington Technology Group.
- Macintosh is a registered trademark of Apple Inc.
- VESA is a registered trademark of the Video Electronics Standards Association.
- Display Data Channel is a trademark of the Video Electronics Standards Association.
- All other trademarks and registered trademarks are trademarks or registered trademarks of their respective holders. In this manual, <sup>TM</sup> and ® marks are not specified.



FixYourDLP.com  
Authorized by DMI

DiscountMerchant.com (800) 281-8860  
THE TRUSTED SOURCE FOR PROJECTOR LAMPS AND ACCESSORIES



**1 Ventilation holes (exhaust)****2 Lens**

Remove the lens cover before projection.

**3 Front remote control detector****4 Control panel**

For details, see “Control Panel” on page 12.

**5 Zoom ring**

Adjusts the picture size.

**6 Focus ring**

Adjusts the picture focus.

**7 Ventilation holes (intake)/Air filter cover****8 Adjusters (fore pad)****9 Lamp cover****10 Adjuster****11 Connector Panel**

For details, see “Connector Panel” on page 14.

**12 AC IN socket**

Connects the supplied AC power cord.

**13 Adjuster adjustment button**

For details, see “Using the adjuster” on page 21.

**14 Speaker****15 Security bar**

An anti-theft chain or wire (commercially available) can be connected to it.

If it is difficult to pull out, pull out the Security bar using a screwdriver.

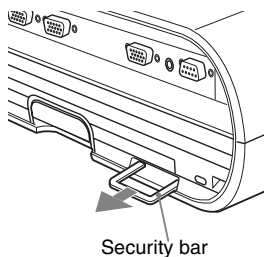
**16 Security lock**

Connects to an optional security cable (from Kensington).

Web page address:

<http://www.kensington.com/>

**Note**

To maintain optimal performance, **clean the air filter whenever you replace the lamp.**

For details, see “Cleaning the Air Filter” on page 42.

## Control Panel

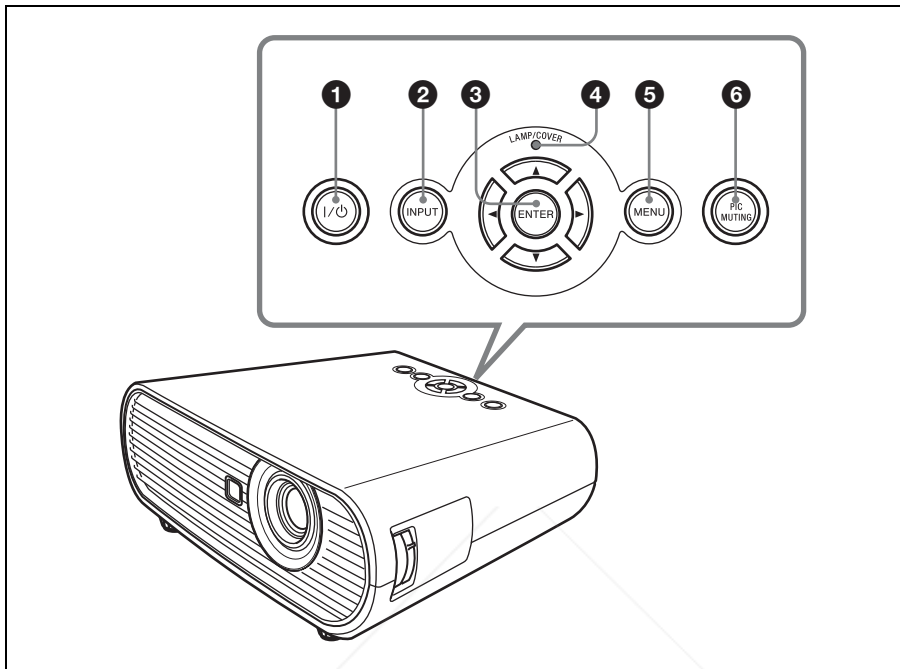

### 1 I/O (On/Standby) key

Turns on the projector when the projector is in standby mode. To turn off the power, press the I/O key twice according to the message or hold the I/O key for about one second.

Lights up or flashes under the following conditions:

- Lights in red when the AC power cord is plugged into a wall outlet. Once the projector is in standby mode, you can turn it on with the I/O key.

- Flashes in red when the temperature becomes high inside the projector, or when the projector fails to operate.

- Lights in green when the power is turned on, and when it is ready to operate.

- Flashes in green from the time when the projector is turned on until the projector is ready to operate. Also, flashes in green while the cooling fan is running after the power is turned off with the I/O key. The fan runs for

about 90 seconds after the power is turned off.

- Lights in orange when the power saving mode is on.

*For detail, see page 22.*

### 2 INPUT key

Selects an input signal. The input signal will change whenever you press the key.

### 3 ENTER/▲/▼/◀/▶ (Arrow) keys

Used to enter the settings of items in the menu system, select a menu, or make various adjustments.

### 4 LAMP/COVER indicators

Flashes in orange under the following conditions:

- A repetition rate of 2 flashes when the lamp cover or air filter cover is not secured firmly.
- A repetition rate of 3 flashes when the lamp has reached the end of its life or reaches a high temperature.

*For detail, see page 45.*

**5 MENU key**

Displays the on-screen menu. Press again to clear the menu.

**6 PIC MUTING key**

Cuts off the picture. Press again to restore the picture.



**Discount-Merchant.com (800) 281-8860**  
**THE TRUSTED SOURCE FOR PROJECTOR LAMPS AND ACCESSORIES**

## Connector Panel

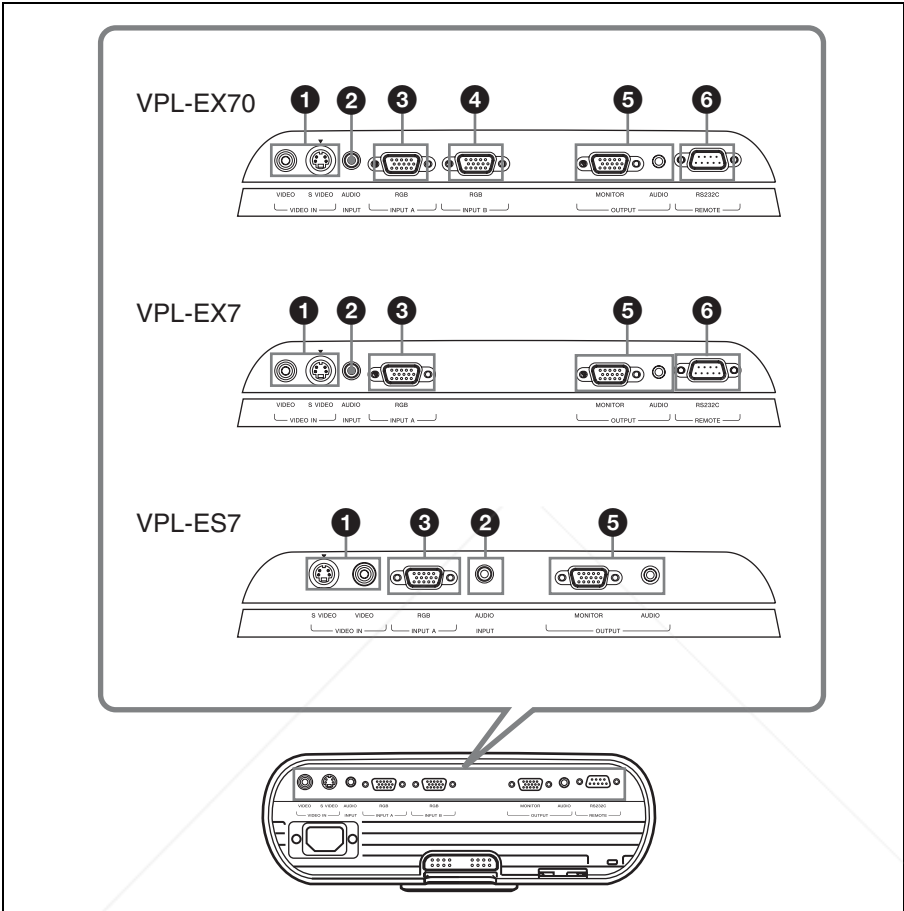

### 1 VIDEO IN connector

- **S VIDEO (mini DIN 4-pin):**  
Connects to the S video output of video equipment.
- **VIDEO (phone type):**  
Connects to the video output of video equipment.

### 2 AUDIO INPUT connector

Inputs audio signal attached to the image from INPUT A, INPUT B (VPL-EX70 only) or VIDEO.

### 3 INPUT A connector

#### RGB (HD D-sub 15-pin, female):

Inputs a computer signal, video GBR signal, component signal, or DTV signal depending on the connected equipment. Connects to the output connector of equipment using the supplied cable or an optional cable.

For details, see "Connecting a Computer" on page 18 and "Connecting a VCR" on page 19.

**4 INPUT B connector**

**RGB connector (HD D-sub 15-pin, female) (VPL-EX70 only):**

Inputs a computer signal.

Connects to the output connector of equipment using the supplied cable or an optional cable.

**5 OUTPUT connector**

• **MONITOR (HD D-sub 15-pin female):**

Connects to the input connector of the monitor. Only the computer signal on the current channel is output from among the signals connected to INPUT A or INPUT B (VPL-EX70 only).

• **AUDIO (stereo minijack):**

Connects to the active speaker. Adjust the volume with VOLUME +/- on the remote commander.

When VIDEO, S VIDEO or INPUT A is selected, the output audio is the signal input to AUDIO INPUT.

**6 REMOTE RS-232C connector (D-sub 9-pin female) (VPL-EX70/EX7 only)**

Connects to the connector of the computer when you operate the projector from the computer.

**Remote Commander**

The keys that have the same names as those on the control panel function identically.

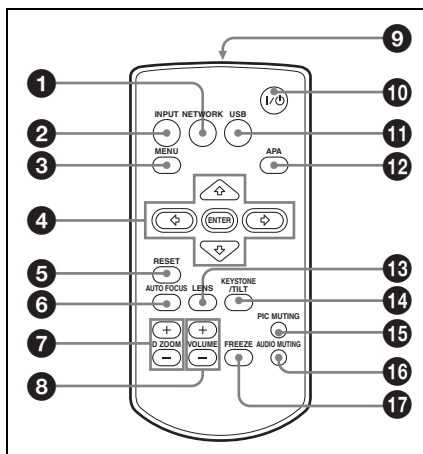
**1 NETWORK key**

This function is not provided in this projector.

**2 INPUT key****3 MENU key****4 ENTER/▲▼/◀▶ (Arrow) keys****5 RESET key**

Resets the value of an item to its factory preset value or returns the enlarged image with D ZOOM key to its original size. This key functions when the menu or a setting item is displayed on the screen.

**6 AUTO FOCUS key**

This function is not provided in this projector.

**7 D ZOOM (Digital Zoom) +/- key**

Enlarges the image at a desired location on the screen. (Digital Zoom function)

**8 VOLUME +/- key****9 Infrared transmitter****10 I/⏻ (On/Standby) key**



### 11 USB key

This function is not provided in this projector.

### 12 APA (Auto Pixel Alignment) key

Automatically adjusts a picture to its clearest while a signal is input from a computer.

For details, see "Smart APA" in "The SET SETTING Menu" on page 33.

### 13 LENS key

This function is not provided in this projector.

### 14 KEYSTONE (Trapezoidal distortion correction) /TILT key

Adjusts the vertical trapezoidal distortion of the image. Pressing this key, the adjustment menu are displayed. Use the arrow keys (▲/▼/◀/▶) for adjustment.

### 15 PIC MUTING key

Cuts off the picture. Press again to restore the picture.

### 16 AUDIO MUTING key

Cuts off the sound. Press again to restore the sound.

### 17 FREEZE key

Freezes the projected picture. To cancel the frozen picture, press the key again. This function is available when the PC signal is input.

## Before using the Remote Commander

Pull out the clear film from the lithium battery holder.

## To replace a battery

1 Pull out the battery cover by a thin stick inserting to a hole, as shown the illustration.

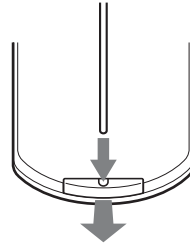

2 Install the lithium battery.

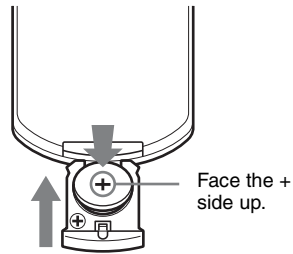

3 Put the lithium battery holder back into the Remote Commander.

## Notes on the lithium battery

- A button type lithium battery (CR2025) is used in the Remote Commander. Do not use batteries other than CR2025.
- Keep the lithium battery out of the reach of children.
- Should the battery be swallowed, immediately consult a doctor.

## Notes on Remote Commander operation

- Make sure that nothing obstructs the infrared beam between the Remote Commander and the remote control detector on the projector. Aim the Remote Commander at the front of the remote control detector or the screen.
- The operation range is limited. The shorter the distance between the Remote Commander and the remote control detector is, the wider the angle within which the commander can control the projector becomes.

# Installing the Projector

The distance between the lens and the screen varies depending on the size of the screen. Use the following table as a guide.

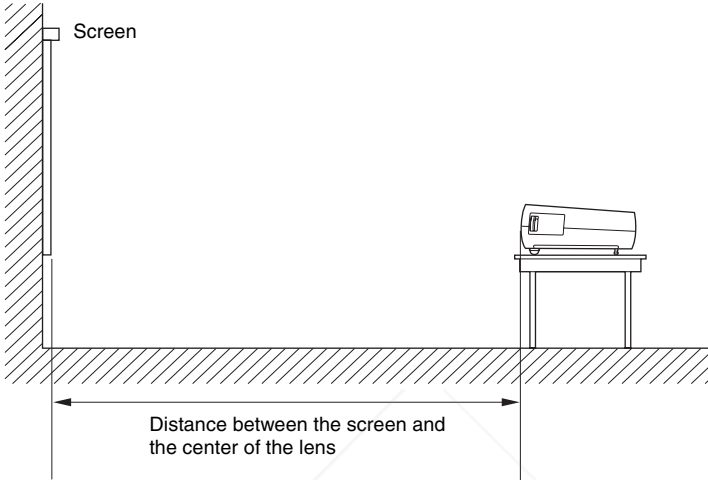

\* Adjuster not stretched, and the V Keystone function has been done.

Unit: m (feet)

Projected image size (diagonal) (inches)	40	80	100	150	200	250	300
<b>Minimum Distance</b>	1.1 (3.6)	2.3 (7.5)	2.9 (9.5)	4.4 (14.4)	5.8 (19.0)	7.3 (24.0)	8.8 (28.9)
<b>Maximum Distance</b>	1.4 (4.6)	2.8 (9.2)	3.5 (11.5)	5.2 (17.1)	7.0 (23.0)	8.8 (28.9)	10.5 (34.5)

There may be a slight difference between the actual value and the design value shown in the table above.



For details on installation, see "Installation Diagram" on page 52.

FIXYourDLP.com  
Sponsored by DM

**Discount-Merchant.com (800) 281-8860**  
THE TRUSTED SOURCE FOR PROJECTOR LAMPS AND ACCESSORIES

Projecting the Picture

# Connecting the Projector

## When you connect the projector, make sure to:

- Turn off all equipment before making any connections.
- Use the proper cables for each connection.
- Insert the cable plugs firmly; loose connections may increase noise and reduce performance of picture signals. When pulling out a cable, be sure to pull it out by the plug, not the cable itself.

## Connecting a Computer

This section describes how to connect the projector to a computer. For more information, refer to the computer's instruction manual.

## To connect a computer

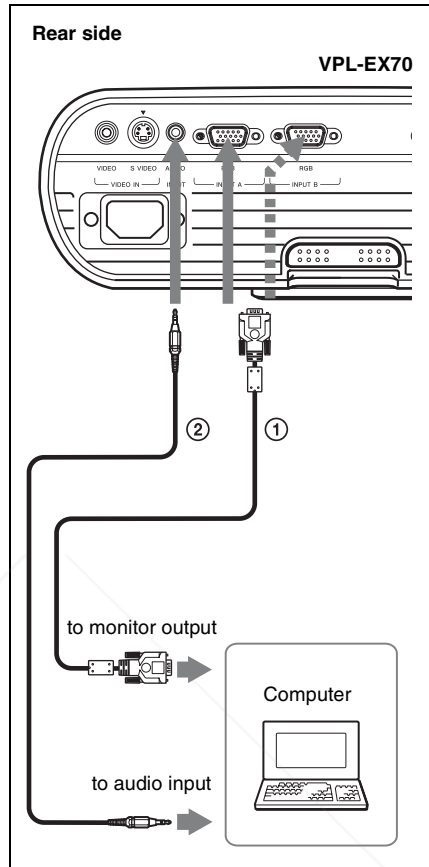

- ① HD D-sub 15-pin cable (supplied)
- ② Stereo audio connecting cable (not supplied)  
(Use a no-resistance cable.)

## Notes

- For stereo audio connection, connect the stereo audio connecting cable to the AUDIO INPUT connector.
- The projector accepts VGA, SVGA, XGA, SXGA, SXGA+, WXGA signals. However, we recommend that you set the output mode of your computer to SVGA (VPL-ES7) or XGA (VPL-EX70/EX7) mode for the external monitor.
- If you set your computer, such as a notebook computer, to output the signal to both your computer's display and the external monitor, the picture of the external monitor may not

appear properly. Set your computer to output the signal to only the external monitor.

For details, refer to the operating instructions supplied with your computer.

**Note**

To connect a Macintosh computer equipped with a video output connector of a type having two rows of pins, use a commercially available plug adaptor.

**Connecting a VCR**

This section describes how to connect the projector to a VCR. For more information, refer to the instruction manuals of the equipment you are connecting.

**To connect to a video or S video output connector**

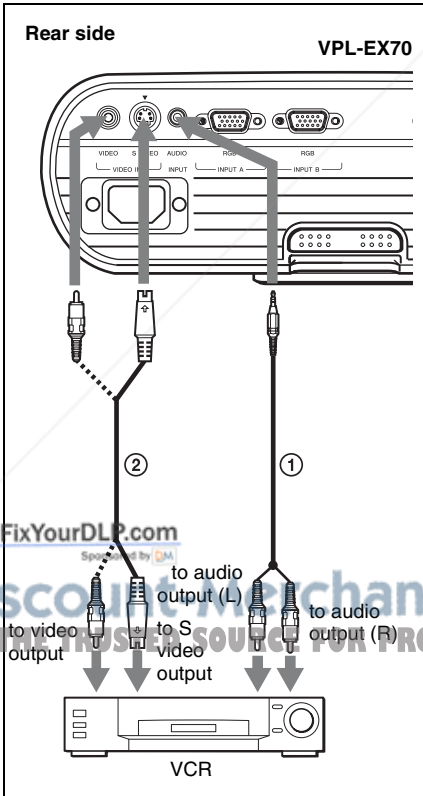

- ① Stereo audio connecting cable (not supplied) (Use a no-resistance cable.)
- ② Video cable (not supplied) or S-Video cable (not supplied)

**To connect to a video GBR/ Component output connector**

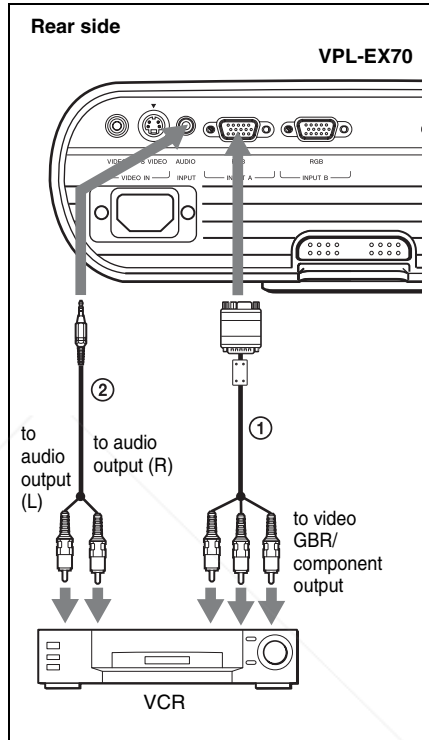

- ① Signal Cable (not supplied) HD D-sub 15-pin (male) ↔ 3 × phono jack
- ② Stereo audio connecting cable (not supplied) (Use a no-resistance cable.)

**Notes**

- For stereo audio connection, connect the stereo audio connecting cable to the AUDIO INPUT connector.
- Set the aspect ratio using “Aspect” on the INPUT SETTING menu according to the input signal.
- When you connect the projector to a video GBR output connector, select “Video GBR” or when you connect the projector to a component output connector, select “Component” with the “Input-A Signal Sel.” setting on the SET SETTING menu.

# Projecting

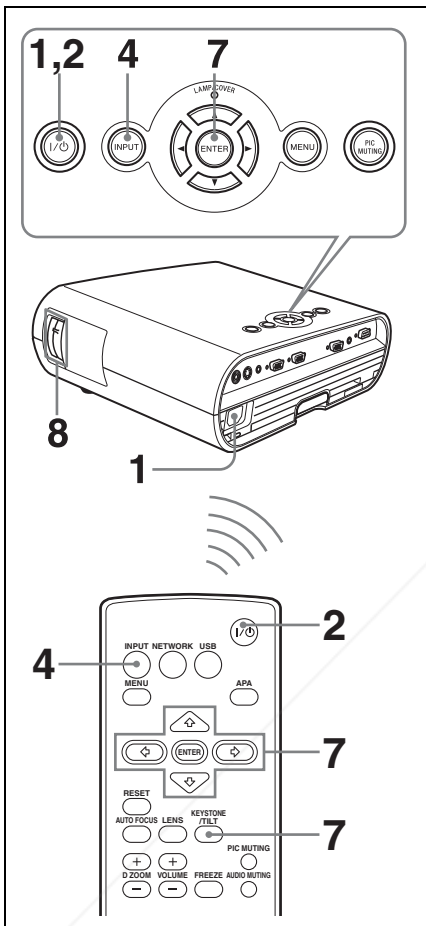

- 1 Plug the AC power cord into a wall outlet, and connect all equipment, then remove the lens cover.
- 2 Press the I/O key. The I/O key lights in red and the projector goes into standby mode.
- 3 Turn on the equipment connected to the projector.

- 4 Press the INPUT key to select the input source.

Each time you press the key, the input signal switches as follows:

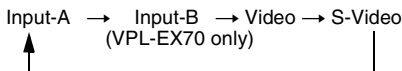

To input from	Press INPUT to display
Computer/Component connected to the INPUT A connector	Input-A
Computer connected to the INPUT B connector (VPL-EX70 only)	Input-B
Video equipment connected to the VIDEO input connector	Video
Video equipment connected to the S VIDEO input connector	S-Video

Smart APA (Auto Pixel Alignment) adjusts the picture of the connected equipment so that it is projected clearly.

## Notes

- If “Auto Input Search” is set to “On,” the projector searches for the signals from the connected equipment and displays the input channel where the input signals are found.
- For details, see “Auto Input Search” on page 33.
- The Smart APA feature is effective for the input analog signal from a computer only.

- 5 Switch the equipment connected to output to the projector. Depending on the type of your computer, for example a notebook, or an all-in-one LCD type, you may have to switch the computer to output to the projector by pressing certain keys (e.g., LCD/VGA, etc.), or by changing your computer’s settings.

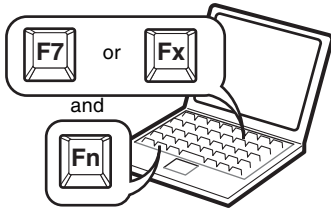

**Note**

The key used for switching the computer to output to the projector varies depending on the type of computer.

- 6 Adjust the upper or lower position of the picture.  
Use the adjuster to adjust the picture position.

**Using the adjuster**

Lift the projector while pressing the adjuster adjustment button, and adjust the tilt of the projector, then release the button to lock the adjuster.

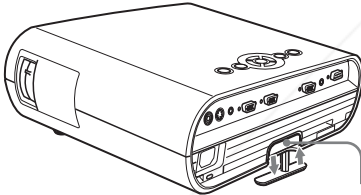

Adjuster adjustment button

**Notes**

- Be careful not to let the projector down on your fingers.
- Do not push hard on the top of the projector or do not drag it hard with the adjuster out. It may cause malfunction.

- 7 Adjust the trapezoidal distortion (▭ ▭) of the picture. (VPL-EX7/ES7 only)  
Press the KEYSTONE key on the Remote Commander to display the adjustment menu and adjust the tilt using the ▲/▼/◀/▶ keys.

**For VPL-EX70**

- When you adjust the tilt of the projector with the adjuster, the V keystone adjustment is performed at the same time. If you do not want to perform the automatic keystone adjustment, set the “V Keystone” to “Manual.” (See page 36.)
- If you set the “V Keystone” to “Auto,” the “V Keystone” correction is automatically adjusted. However, it may not be perfectly adjusted depending on the room temperature or the screen angle. In this case, adjust it manually. Press the KEYSTONE key to “V Keystone” displays on the screen, and adjust the value with the ▲/▼/◀/▶ keys.

- 8 Adjust the size of the picture and the focus.  
Adjust the picture size using the Zoom ring and adjust the picture focus using the Focus ring.

7xYourDL.com  
 Discount-Merchant.com (800) 281-8860  
 THE BEST SOURCE FOR PROJECTOR LAMPS AND ACCESSORIES

---

# Turning Off the Power

- 1 Press the I/⏻ key.  
“POWER OFF? Please press I/⏻ key again.” appears to confirm that you want to turn off the power.

## Note

The message disappears if you press any key other than the I/⏻ key, or if you do not press any key for five seconds.

- 2 Press the I/⏻ key again.  
The I/⏻ key flashes in green and the fan continues to run to reduce the internal heat. Also, the I/⏻ key flashes quickly for the first 60 seconds. During this time, you will not be able to light up the I/⏻ key again with the I/⏻ key.
- 3 Unplug the AC power cord from the wall outlet after the fan stops running and the I/⏻ key lights in red. (Except when using the Direct Power On/Off function or the Off & Go function.)



**Discount-Merchant.com (800) 281-8860**  
**THE TRUSTED SOURCE FOR PROJECTOR LAMPS AND ACCESSORIES**

## ► Convenient Functions

# Selecting the Menu Language

You can select one of seventeen languages for displaying the menu and other on-screen displays. The factory setting is English. To change the menu language, proceed as follows:

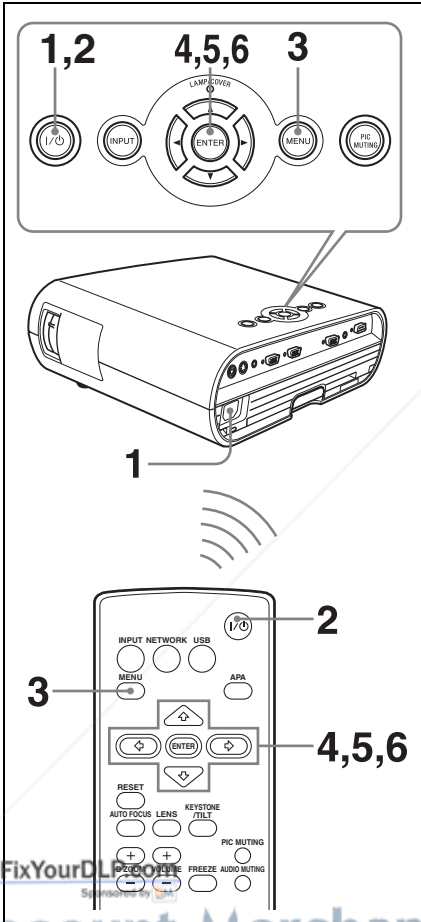

- 1 Plug the AC power cord into a wall outlet.
- 2 Press the I/O key to turn on the projector.
- 3 Press the MENU key. The menu appears.

The menu currently selected is shown as a yellow button.

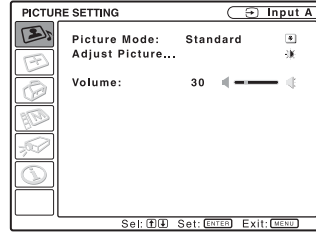

- 4 Press the ▲ or ▼ key to select the MENU SETTING menu, then press the ► or ENTER key. The selected menu appears.

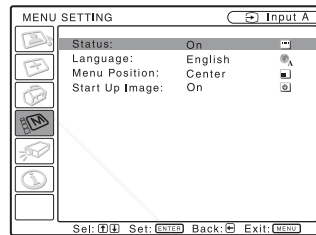

- 5 Press the ▲ or ▼ key to select "Language," then press the ► or ENTER key.

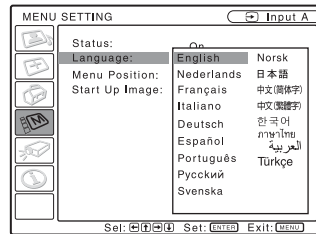

- 6 Press the ▲, ►, ◀ or ▼ key to select a language, then press the ENTER key. The menu changes to the selected language.

### To clear the menu

Press the MENU key.

The menu disappears automatically if a key is not pressed for one minute.



# Security Lock

The projector is equipped with a security lock function. When you turn the power of the projector on, you are required to input the previously set password. If you do not input the correct password, you will not be able to project the picture.

## Notes

- You will not be able to use the projector if you forget your password and the password administrator is not available. Be please aware that using the security lock can prevent valid usage in such cases.
- When you set the security lock being active, the password will be necessary only when the power is turned on after plugging the power cord.

## To use the security lock

- 1 Press the MENU key and then, on the INSTALL SETTING menu, turn on the “Security Lock” setting.
- 2 Enter the password.  
Use the MENU, ▲/▼/◀/▶, and ENTER keys to enter the four-digit password. (The default initial password setting is “ENTER, ENTER, ENTER, ENTER.” After this is entered you can put in your own password. Therefore, when you use this function for the first time, please input “ENTER” four times.)

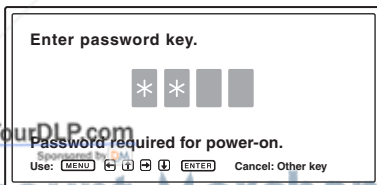

Next, the screen for entering the new password is displayed. (Enter the password on this screen even if you want to keep the current password.)

Enter the password on this screen.

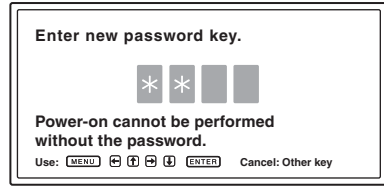

- 3 Enter the password again to confirm.

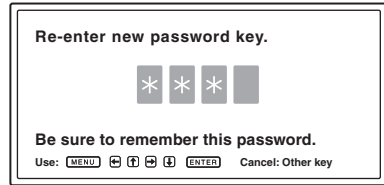

When the following message is displayed, the setting for security lock is completed.

Security Lock enabled!

If “Invalid Password!” is displayed on the screen, perform this procedure again from step 1.

Invalid Password!

- 4 Turn the main power off and disconnect the AC power cord.  
The security lock is set to on, then it becomes effective. The screen used for entering the password is displayed when the power is turned on the next time.

## Security certification

When the password screen is displayed, enter the password that was set. If you fail to enter the correct password after three times, the projector cannot be used. In this case, press the I/O key to turn off the power.

## To cancel the security lock

- 1 Press the MENU key, then turn off the “Security Lock” setting on the INSTALL SETTING menu.

- 2 Enter the password.  
Enter the password that was set.

#### Note

If you call the customer service center because you have forgotten the password, you will need to be able to verify the projector's serial number and your identity. (This process may differ in other countries/regions.) Once your identity has been confirmed, we will provide you with the password.

## Other Functions

### Direct Power On/Off Function

If you will be using a circuit breaker to turn the power for the entire system on and off, set the direct power on function to "On." You can turn the power on/off without pressing the power key on the projector.

### Off & Go Function

If you are leaving the conference room immediately, turn the projector off, and then, you can unplug the AC power cord.

#### Note

When you restart the power immediately after turning it off using the Off & Go function, the power may not come back on. In that case, wait a few minutes and turn on the power again.

### Effective Tools for Your Presentation

#### To enlarge the image (Digital Zoom function)

You can select a section of the image to enlarge. This function works when a signal from a computer is input. This function does not work when a video signal is input.

- 1 Project a normal image, and press the D ZOOM + key on the Remote Commander.

The digital zoom icon appears in the center of the image.

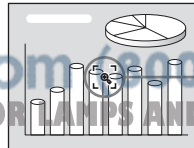

Digital zoom icon

**2** Move the icon to the point on the image you want to enlarge. Use the arrow key (▲/▼/◀/▶) to move the icon.

**3** Press the D ZOOM + key again. The portion of the image where the icon is located is enlarged. The enlargement ratio is displayed on the screen for a few seconds. By pressing the + key repeatedly, the image size (ratio of enlargement: max. 4 times) increases.

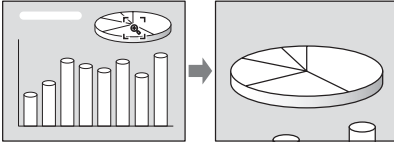

Use the arrow key (▲/▼/◀/▶) to scroll the enlarged image.

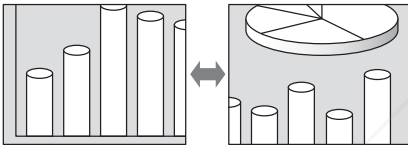

### To return the image to its original size

Press the D ZOOM – key.  
Just pressing the RESET key returns the image back to its original size immediately.

---

### To freeze the image projected (Freeze function)

Press the FREEZE key. “Freeze” appears when the key is pressed. This function works when a signal from a computer is input. To restore the original screen, press the FREEZE key again.



**Discount-Merchant.com (800) 281-8860**  
**THE TRUSTED SOURCE FOR PROJECTOR LAMPS AND ACCESSORIES**

## ► Adjustments and Settings Using a Menu

# Using a MENU

The projector is equipped with an on-screen menu for making various adjustments and settings.

### Display items

Input signal indicator

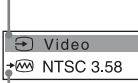

Input signal setting indicator

Picture adjustment menu



### Input signal indicator

Shows the selected input channel. X(→) is displayed when no signal is input. You can hide this indicator using “Status” on the MENU SETTING menu.

### Input signal setting indicator

**For Input-A:** Shows “Auto” or “Input-A Signal Sel.” setting on the SET SETTING menu.

**For Video/S-Video input:** Shows “Auto” or the “Color System” setting on the SET SETTING menu.

**1** Press the MENU key.

The menu appears.

The menu presently selected is shown as a yellow button in the column on the left.

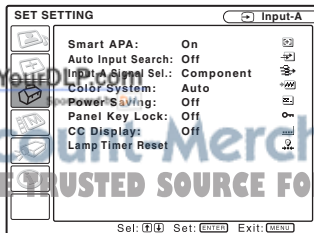

**2** Use the ▲ or ▼ key to select a menu, then press the ► or ENTER key.

The selected menu appears.

**3** Select an item.

Use the ▲ or ▼ key to select the item, then press the ► or ENTER key.

The setting items are displayed in a pop-up menu or in a sub menu.

### Pop-up menu

Menu Setting items Selected input signal

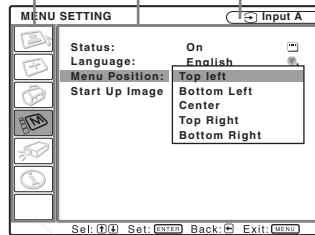

### Sub menu

Menu Setting items

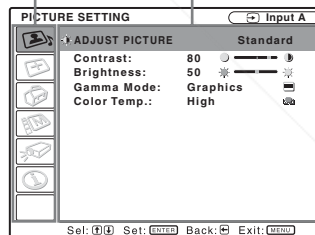

**4** Make the setting or adjustment of an item.

• **When changing the adjustment level:**

To increase the number, press the ▲ or ► key.

To decrease the number, press the ▼ or ◀ key.

Press the ENTER key to restore the previous screen.

• **When changing the setting:**

Press the ▲ or ▼ key to change the setting.

Press the ENTER or ◀ key to restore the previous screen.

---

### To clear the menu

Press the MENU key.

The menu disappears automatically if a key is not pressed for one minute.

---

### To reset items that have been adjusted

Select the item that you want to reset, and then press the RESET key on the Remote Commander.

“Complete!” appears on the screen and **the setting of the item that you have selected is reset to its factory preset value.**

Items that can be reset are:

- “Contrast,” “Brightness,” “Color,” “Hue” and “Sharpness” on the “Adjust Picture...” menu of the PICTURE SETTING menu
- “Dot Phase,” “H Size,” and “Shift” on the “Adjust Signal...” menu of the INPUT SETTING menu

---

### Storage of the settings

The settings are automatically stored in the projector memory when the ENTER key is pressed.

---

### If no signal is input

If there is no input signal, “Cannot adjust this item.” appears on the screen.

---

### Unadjustable items

Items that cannot be adjusted, depending on the input signal, are not displayed on the menu.

*For details, see page 39.*



**Discount-Merchant.com (800) 281-8860**  
**THE TRUSTED SOURCE FOR PROJECTOR LAMPS AND ACCESSORIES**

# The PICTURE SETTING Menu

The PICTURE SETTING menu is used for adjusting the picture or volume. Items that can be adjusted or set depend on the kind of input signals.

For details, see “Input signals and adjustable/setting items” on page 39.

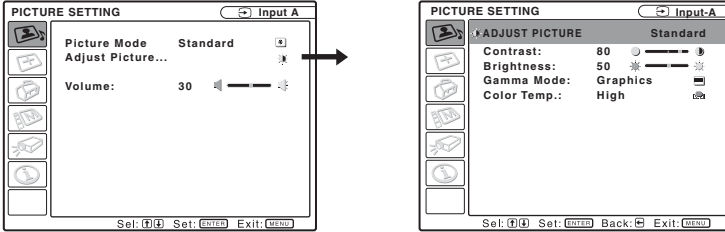

Setting items	Functions	Initial setting
Picture Mode	<p>Selects the picture mode.</p> <ul style="list-style-type: none"> <li>• <b>Dynamic:</b> Emphasizes the contrast to produce a “dynamic” picture.</li> <li>• <b>Standard:</b> Selects for the standard picture.</li> <li>• <b>Game:</b> Select for viewing game picture.</li> <li>• <b>Living:</b> Select for viewing sports, music, digital video camera picture.</li> <li>• <b>Cinema:</b> Select for viewing film-like picture.</li> <li>• <b>Presentation:</b> Makes the picture suitably bright for a presentation when the signal is input from a computer.</li> </ul>	Set according to the input signal
Adjust Picture...	The unit can store the setting values of the following sub menu items for each picture mode separately.	
Contrast	Adjusts the picture contrast.	80
Brightness	Adjusts the picture brightness.	50
Color	Adjusts color intensity.	50
Hue	Adjusts color tones. The higher the setting, the more greenish the picture becomes. The lower the setting, the more purplish the picture becomes.	50
Sharpness	Adjusts the picture sharpness. The higher the setting, the sharper the picture becomes. The lower the setting, the softer the picture becomes.	30
Gamma Mode	<p>Selects a gamma correction curve.</p> <ul style="list-style-type: none"> <li>• <b>Graphics:</b> Improves the reproduction of halftones. Photos can be reproduced in natural tones.</li> <li>• <b>Text:</b> Contrasts black and white. Suitable for images that contain lots of text.</li> </ul>	Graphics

Setting items	Functions	Initial setting
Color Temp.	Adjusts the color temperature. <ul style="list-style-type: none"> <li>• <b>High:</b> Makes white colors bluish.</li> <li>• <b>Middle:</b> Makes white part of the picture natural white.</li> <li>• <b>Low:</b> Makes white colors reddish.</li> </ul>	Set according to the input signal
DDE (Dynamic Detail Enhancer)	Selects the mode to play the input video signal according to the material. <ul style="list-style-type: none"> <li>• <b>Off:</b> Plays back the interlace format without conversion.</li> <li>• <b>Progressive:</b> Plays back the video picture of the interlace format converting to progressive.</li> <li>• <b>Film:</b> Plays back a smooth picture in a software of 2-2, 2-3 pull-down type like a movie. When other than the software of 2-2, 2-3 pull-down type is played back, it is automatically switched to "Progressive".</li> </ul>	Film
Volume	Adjusts the volume.	30



**Discount-Merchant.com (800) 281-8860**  
**THE TRUSTED SOURCE FOR PROJECTOR LAMPS AND ACCESSORIES**

# The INPUT SETTING Menu

The INPUT SETTING menu is used to adjust the input signal.

## When the signal is input from a computer

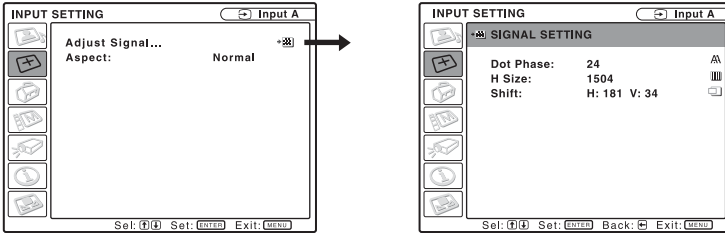

Setting items	Functions	Initial setting
Adjust Signal...		
Dot Phase	Adjusts the dot phase of the LCD panel and the signal output from a computer. Adjust the picture further for finer picture after the picture is adjusted by pressing the APA key.	Set according to the input signal
H Size	Adjusts the horizontal size of a picture output from a computer. Adjust the setting according to the dots of the input signal. For details, see page 50.	Set according to the input signal
Shift	Adjusts the position of the picture. H adjusts the horizontal position of the picture. V adjusts the vertical position of the picture. As the setting for H increases, the picture moves to the right, and as the setting decreases, the picture moves to the left. As the setting for V increases, the picture moves up, and as the setting decreases, the picture moves down. Use the ◀ or the ▶ key to adjust the horizontal position and the ▲ and ▼ key for the vertical position.	Set according to the input signal
Aspect (When the video signal is input)	You can set the aspect ratio of the picture to be displayed for the current input signal. This item is enabled only when an video signal (preset memory numbers 1 to 11) is input. <ul style="list-style-type: none"> <li>• <b>4:3</b>: Makes the aspect ratio 4:3.</li> <li>• <b>16:9</b>: Select to view a picture squeezed.</li> <li>• <b>Zoom</b>: Select to enlarge the original picture without distorting the aspect ratio. (Only when a preset memory number 1 to 6 is input.)</li> </ul>	Set according to the input signal



Setting items	Functions	Initial setting
Aspect (When the PC signal is input)	<p>You can set the aspect ratio of the picture to be displayed for the current input signal. This item is enabled only when an PC signal (preset memory numbers 21 to 63) is input.</p> <ul style="list-style-type: none"> <li>• <b>Full 1:</b> Displays a picture vertically or horizontally to fill the screen without changing the aspect ratio of the original picture.</li> <li>• <b>Full 2:</b> The original image is projected fully in the window.</li> <li>• <b>Normal:</b> Displays the picture while matching one pixel of input picture element to that of the LCD. The picture will be clear but the picture size will be smaller.</li> </ul>	Set according to the input signal

### Notes

- For Aspect, some of the “Aspect” setting items are not displayed on the screen according to the input signal.
- Note that if the projector is used for profit or for public viewing, modifying the original picture by switching to the wide mode may constitute an infringement of the rights of authors or producers, which are legally protected.

### About the Preset Memory No.

This projector has 45 types of preset data for input signals (the preset memory). When a preset signal is input, the projector automatically detects the signal type and recalls the data for the signal from the preset memory to adjust it to an optimum picture. The memory number and signal type of that signal are displayed on the INFORMATION menu (See page 38). You can also adjust the preset data through the INPUT SETTING menu.

*See the chart on page 50 to find if the signal is registered in the preset memory.*

### Note

When the aspect ratio of input signal is other than “Full 2”, a part of the screen may be displayed in black.



FixYourDLP.com  
Sponsored by D.M.

**Discount-Merchant.com (800) 281-8860**  
**THE TRUSTED SOURCE FOR PROJECTOR LAMPS AND ACCESSORIES**

# The SET SETTING Menu

The SET SETTING menu is used for changing the settings of the projector.

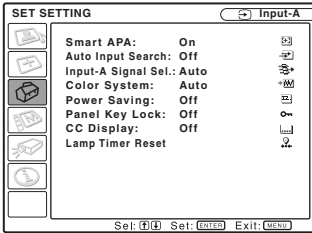

Setting items	Functions	Initial setting
Smart APA	<p>The APA (Auto Pixel Alignment) automatically adjusts “Dot Phase,” “H Size” and “Shift” on the INPUT SETTING menu for the input signal from a computer.</p> <ul style="list-style-type: none"> <li>• <b>On:</b> When a signal is input from a computer, the APA functions automatically so that the picture can be seen clearly. You can adjust the picture by pressing the APA key on the Remote Commander even if “Smart APA” set to “On.”</li> <li>• <b>Off:</b> The APA functions when you press the APA key on the Remote Commander.</li> </ul>	On
Auto Input Search	<p>When set to “On,” the projector detects input signals in the following order: Input-A/Input-B (VPL-EX70 only)/Video/S-Video. It indicates the input channel when the power is turned on or the INPUT key is pressed.</p>	Off
Input-A Signal Sel.	<p>Selects the type of signal input from the equipment connected to the INPUT A connector. Selects the type of signal input from the equipment by selecting “Input-A” with the INPUT key.</p> <ul style="list-style-type: none"> <li>• <b>Auto:</b> Selects the input signal type automatically.</li> <li>• <b>Computer:</b> Inputs the signal from a computer.</li> <li>• <b>Component:</b> Inputs the component signal from a DVD player/recorder, Blu-ray Disc player, digital tuner, etc.</li> <li>• <b>Video GBR:</b> Inputs the signal from a TV game or HDTV broadcast.</li> </ul>	Auto
Color System	<p>Selects the color system of the input signal. If you select “Auto,” the projector detects the color system of the input signal automatically. If the picture is distorted or colorless, select the color system according to the input signal.</p>	Auto

Setting items	Functions	Initial setting
Power Saving	<p>Selects the Power Saving mode.</p> <ul style="list-style-type: none"> <li>• <b>Lamp off:</b> The lamp goes off if no signal is input for 10 minutes. The lamp lights again when a signal is input or any key is pressed.</li> <li>• <b>Standby:</b> The projector goes into Standby mode if no signal is input for 10 minutes. To use it, turn on the power again.</li> <li>• <b>Off:</b> The projector does not go into Power Saving mode.</li> </ul>	Off
Panel Key Lock	<p>Locks all the control panel keys on the top panel of the projector so that the projector can be operated only with the Remote Commander.</p> <p>To lock the control panel keys, set to “On.”</p> <p>When it is set to “On,” keeping the I/⏻ key on the control panel pressed for 10 seconds turns the projector on when it is in standby mode, and turns the projector to standby mode when the power is on.</p> <p>If you press and hold the MENU key for about 10 seconds when the power is on, the lock will be released and “Panel Key Lock” is automatically set to “Off.”</p>	Off
CC Display	<p>Turns on or off the Closed Captions (CC) function.</p> <ul style="list-style-type: none"> <li>• <b>Off:</b> Turns off the Closed Captions (CC) function.</li> <li>• <b>CC1/CC2/CC3/CC4/TEXT1/TEXT2/TEXT3/TEXT4:</b> Selects a displayed version of the dialogue or sound channel of a program.</li> </ul>	Off
Lamp Timer Reset	When replacing the lamps, reset the lamp timer.	–

### Notes

- Press the APA key when the full image is displayed on the screen. If the projected image includes a black portion around it, the APA function will not work properly and some parts of the image may not be displayed on the screen.
  - You can cancel the adjustment by pressing the APA key again while “Adjusting” appears on the screen.
  - The picture may not be adjusted properly depending on the type of input signal.
  - Adjust the “Dot Phase,” “H Size,” and “Shift” items on the INPUT SETTING menu when you adjust the picture manually.
- If the input signal is not displayed correctly when the input A signal classifying is set to “Auto”, set it to conform the input signal.
- Closed Captioning is not displayed in the following cases:
  - while you are adjusting the volume with VOLUME +/- on the remote commander
  - while you are operating on-screen menus
  - while “Please replace the Lamp.” is displayed on the screen

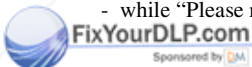

**Discount-Merchant.com (800) 281-8860**  
**THE TRUSTED SOURCE FOR PROJECTOR LAMPS AND ACCESSORIES**

# The MENU SETTING Menu

The MENU SETTING menu is used for changing the menu displays.

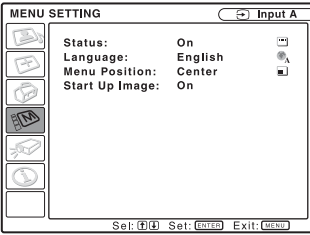

Setting items	Functions	Initial setting
Status (on-screen display)	Sets up the on-screen display. When set to “Off,” turns off the on-screen displays except for the menus, a message when the power is turned off, and warning messages.	On
Language	Selects the language used in the menu and on-screen displays. The languages available are: English, Nederlands, Français, Italiano, Deutsch, Español, Português, Русский, Svenska, Norsk, 日本語, 中文(简体字), 中文(繁體字), 한국어, ภาษาไทย, العربية and Türkçe.	English
Menu Position	Selects the display position of the menu from “Top Left,” “Bottom Left,” “Center,” “Top Right,” and “Bottom Right.”	Center
Start Up Image	<ul style="list-style-type: none"> <li>• <b>On:</b> Displays the Start Up Image in the window after turning on the power.</li> <li>• <b>Off:</b> Does not displays the Start Up Image in the window after turning on the power.</li> </ul>	On

# The INSTALL SETTING Menu

The INSTALL SETTING menu is used for changing the settings of the projector.

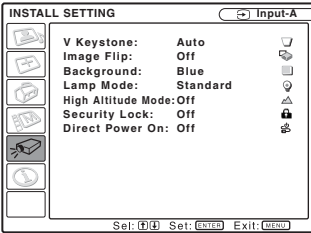

Setting items	Functions	Initial setting
V Keystone (VPL-EX70 only)	Corrects the trapezoidal distortion caused by the projection angle. Select “Auto” for automatic correction, or “Manual” for manual correction using the ▲/▼/◀/▶ keys. <b>When the bottom of the trapezoid is longer than the top</b> □ : Sets a lower value. <b>When the top of the trapezoid is longer than the bottom</b> □ : Sets a higher value.	Auto
V Keystone (VPL-EX7/ES7 only)	Corrects the trapezoidal distortion caused by the projection angle using the ▲/▼/◀/▶ keys on the Remote Commander. <b>When the bottom of the trapezoid is longer than the top</b> □ : Sets a lower value. <b>When the top of the trapezoid is longer than the bottom</b> □ : Sets a higher value.	0
Image Flip	Flips the image on the screen horizontally and/or vertically. • <b>HV</b> : Flips the image horizontally and vertically. • <b>H</b> : Flips the image horizontally. • <b>V</b> : Flips the image vertically. • <b>Off</b> : The image does not flip.	Off
Background	Selects the background color of the screen when no signal is input to the projector. Select “Black” or “Blue.” Normally, set to “Blue.”	Blue
Lamp Mode	Sets the lamp brightness used during the projection. • <b>High</b> : Illuminates the projected image brightly. • <b>Standard</b> : Reduces fan noise and power consumption. The brightness of the projected image will be lower compared with the “High” setting.	Standard
High Altitude Mode	Set to “On” when the projector is used at an altitude of 1,500 m or higher.	Off
Security Lock	Turns on the projector’s security lock function. When set to “On,” turns on the security lock function, which locks the projector once a password has been set. <i>For details, see “Security Lock” on page 24.</i>	Off
Direct Power On	Set to “On” if you are using a circuit breaker to turn the power on/off the entire system. You can turn the power on/off without pressing the power key on the projector.	Off

## Notes

- The picture quality may deteriorate when the V Keystone function is used, because it is an electrical correction.
- If you set “High Altitude Mode” to “On” at an altitude of under 1,500 m, the reliability of the lamp may be reduced.

## Notes on VPL-EX70

- The auto V Keystone adjustment may not correct the trapezoidal distortion perfectly, depending on the room temperature or the screen angle.
- If you need fine adjustment when V Keystone is set to “Auto”, press the KEYSTONE key on the control panel or the remote commander, and change the value. The setting mode will be temporarily changed to “Manual” from “Auto”.  
If you want restore the “Auto” setting, first switch the V Keystone setting to “Manual”, then return it to “Auto”.
- When you want to apply the fine adjustment value the next time, change the V Keystone setting to “Manual” from “Auto”.



**Discount-Merchant.com (800) 281-8860**  
**THE TRUSTED SOURCE FOR PROJECTOR LAMPS AND ACCESSORIES**

# The INFORMATION Menu

The INFORMATION menu displays the model name, serial number, the horizontal and vertical frequencies of the input signal and the cumulated hours of usage of the lamp.

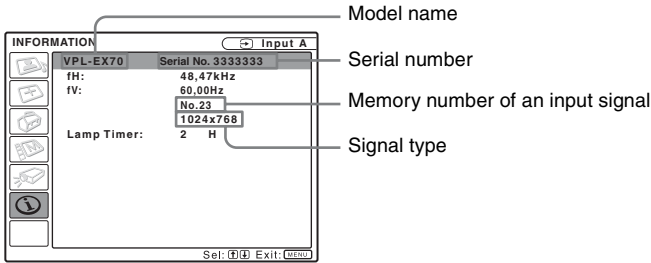

Setting items	Functions
fH	Displays the horizontal frequency of the input signal. The displayed value is approximate.
fV	Displays the vertical frequency of the input signal. The displayed value is approximate.
Lamp Timer	Indicates how long the lamp has been turned on.

**Note**

These are only displayed on the screen. You cannot alter the display, and these is no setting to be altered.



**Discount-Merchant.com (800) 281-8860**  
THE TRUSTED SOURCE FOR PROJECTOR LAMPS AND ACCESSORIES

## Input signals and adjustable/setting items

Some of the items in the menus cannot be adjusted depending on the input signal as indicated in the following tables.

The items that cannot be adjusted are not displayed in the menu.

### PICTURE SETTING menu

Item	Input signal			
	Video or S-Video (Y/C)	Component	Video GBR	Computer
Picture Mode	●	●	●	●
Adjust Picture...				
Contrast	●	●	●	●
Brightness	●	●	●	●
Color	●	●	●	—
Hue	● (NTSC 3.58/4.43 only)	●	●	—
Sharpness	●	●	●	—
Gamma Mode	—	—	—	●
Color Temp.	●	●	●	●*2
DDE	●	● (Interlace format only)*1	● (Interlace format only)*1	—
Volume	●	●	●	●

● : Adjustable/can be set

— : Not adjustable/cannot be set

\*1: Except for preset memory No. 7, 8

\*2: Cannot be set in the Presentation mode

### INPUT SETTING menu

Item	Input signal			
	Video/S-Video (Y/C)	Component	Video GBR	Computer
Aspect	●	●	●	●*3
Adjust Signal...				
Dot Phase	—	—	—	●
H size	—	—	—	●
Shift	—	●	●	●

● : Adjustable/can be set

— : Not adjustable/cannot be set

\*3. Can be set except preset memory number 49



## Replacing the Lamp

The lamp used as a light source is consumable product. Thus replace the lamp with a new one in the following cases.

- When the lamp has burnt out or dims
- “Please replace the Lamp.” appears on the screen
- The LAMP/COVER indicator lights up (repeats flashing three times)

The lamp life varies depending on conditions of use.

Use an LMP-E191 Projector Lamp as the replacement lamp.

Use of any other lamps than the LMP-E191 may cause damage to the projector.

### Notes

- **If the lamp breaks, ask qualified Sony personnel to replace the lamp and to check inside.**
- Pull out the lamp by holding the handle.
- When removing the lamp, make sure it remains horizontal, then pull straight up. Do not tilt the lamp. If you pull out the lamp while it is tilted and if the lamp breaks.

- 1 Turn off the projector, and disconnect the AC power cord from the AC outlet.

### Note

When replacing the lamp after using the projector, wait for at least an hour for the lamp to cool.

- 2 Place a protective sheet (cloth) beneath the projector. Turn the projector over so you can see its underside.

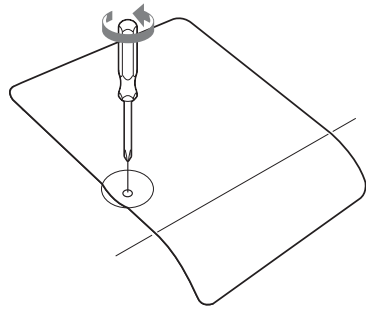

### Note

For safety reasons, do not loosen any other screws.

- 4 Loosen the two screws on the lamp unit with the Phillips screwdriver (1). Fold out the handle (2), then pull out the lamp unit by the handle (3).

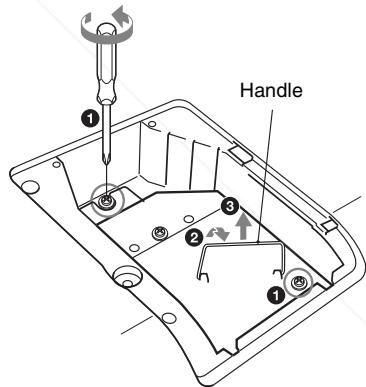

### Note

Be sure that the projector is stable after turning it over.

- 3 Open the lamp cover by loosening the screw with a Phillips screwdriver.

- 5 Insert the new lamp all the way in until it is securely in place (1). Tighten the two screws (2). Fold down the handle to replace it (3).

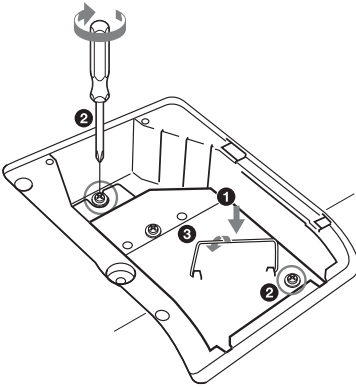

#### Notes

- Be careful not to touch the glass surface of the lamp.
- The power will not turn on if the lamp is not secured properly.
- Do not allow any liquid or other objects into the slot **to avoid electrical shock or fire.**

- 6 Close the lamp cover and tighten the screw.

#### Note

Be sure to attach the lamp cover securely as it was. If not, the projector cannot be turned on.

- 7 Turn the projector back over.

- 8 Connect the power cord.  
The I/⏻ key lights in red.

- 9 Press the I/⏻ key to turn the projector on.

- 10 Press the MENU key, and then select the SET SETTING menu.

- 11 Select “Lamp Timer Reset”, and then press the ENTER key.

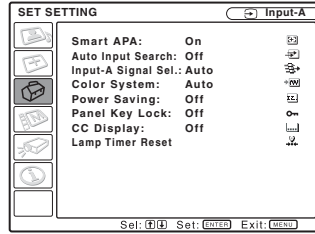

- 12 Select “Execute” with the ▼ key, and then press the ENTER key.

The Lamp Timer is initialized to 0, and “Change the Lamp and clean the Filter?” is displayed in the menu screen.

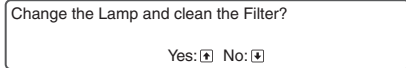

Refer to page 42 for “Cleaning the Air Filter”.

- 13 Select “Yes” with the ▲ key.

“Lamp Timer Reset Complete!” is displayed in the menu screen.

### Disposal of the used lamp

#### For the customers in the USA

Lamp in this product contains mercury. Disposal of these materials may be regulated due to environmental considerations. For disposal or recycling information, please contact your local authorities or the Electronic Industries Alliance ([www.eiae.org](http://www.eiae.org)).

# Cleaning the Air Filter

The air filter should be cleaned whenever you replace the lamp. Remove the air filter, and then remove the dust with a vacuum cleaner.

The time needed to clean the air filter will vary depending on the environment or how the projector is used.

When it becomes difficult to remove the dust from the filter with a vacuum cleaner, remove the air filter and wash it.

- 1 Turn the power off and unplug the power cord.
- 2 Draw out the air filter cover and remove it.

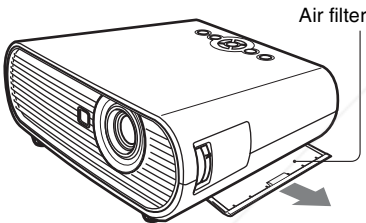

- 3 Remove the air filter.

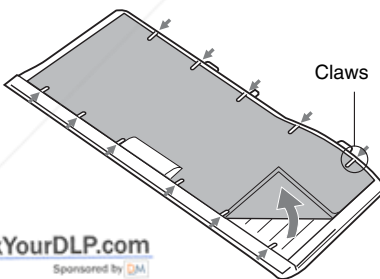

- 4 Wash the air filter with a mild detergent solution and dry it in a shaded place.
- 5 Attach the air filter so that it fits into the each claws on the air filter cover and replace the cover.

## Notes

- If you neglect to clean the air filter, dust may accumulate, clogging it. As a result, the temperature may rise inside the unit, leading to a possible malfunction or fire.
- Be sure to attach the air filter cover firmly; the power can not be turned on if it is not closed securely.
- The air filter has a face and a reverse side. Place the air filter so that it fits in a notch on the air filter cover.

# Troubleshooting

If the projector appears to be operating erratically, try to diagnose and correct the problem using the following instructions. If the problem persists, consult with qualified Sony personnel.

## Power

Symptom	Cause and Remedy
The power is not turned on.	<ul style="list-style-type: none"> <li>• The power has been turned off and on with the I/⏻ key at a short interval.                             <ul style="list-style-type: none"> <li>→ Wait for about 90 seconds before turning on the power (see page 22).</li> </ul> </li> <li>• The lamp cover is not secured.                             <ul style="list-style-type: none"> <li>→ Close the lamp cover securely (see page 41).</li> </ul> </li> <li>• The air filter cover is detached.                             <ul style="list-style-type: none"> <li>→ Attach the air filter cover securely (see page 42).</li> </ul> </li> </ul>

## Picture

Symptom	Cause and Remedy
No picture.	<ul style="list-style-type: none"> <li>• A cable is disconnected or the connections are wrong.                             <ul style="list-style-type: none"> <li>→ Check that the proper connections have been made (see page 18).</li> </ul> </li> <li>• The connections are wrong.                             <ul style="list-style-type: none"> <li>→ This projector is compatible with DDC2B (Digital Data Channel 2B). If your computer is compatible with DDC, turn the projector on according to the following procedures.                                     <ol style="list-style-type: none"> <li>1 Connect the projector to the computer.</li> <li>2 Turn the projector on.</li> <li>3 Start the computer.</li> </ol> </li> </ul> </li> <li>• Input selection is incorrect.                             <ul style="list-style-type: none"> <li>→ Select the input source correctly (see page 20).</li> </ul> </li> <li>• The picture is muted.                             <ul style="list-style-type: none"> <li>→ Press the PIC MUTING key to release the picture muting (see page 16).</li> </ul> </li> <li>• The computer signal is not set to output to an external monitor or set to output both to an external monitor and a LCD monitor of a computer.                             <ul style="list-style-type: none"> <li>→ Set the computer signal to output <b>only</b> to an external monitor (see page 18).</li> </ul> </li> </ul>
The picture is noisy.	Noise may appear on the background depending on the combination of the number of dots input from the computer and the numbers of pixels on the LCD panel. <ul style="list-style-type: none"> <li>→ Change the desktop pattern on the connected computer.</li> </ul>
The picture from the INPUT A connector is colored strangely.	The input signal cannot be received at “Auto” of “Input-A Signal Sel” on the SET SETTING menu, or the setting of “Input-A Signal Sel” is incorrect. <ul style="list-style-type: none"> <li>→ Selects “Computer”, “Video GBR” or “Component” correctly according to the input signal (see page 33).</li> </ul>

Symptom	Cause and Remedy
On-screen display does not appear.	<p>“Status” on the MENU SETTING menu has been set to “Off.”</p> <p>→ Set “Status” on the MENU SETTING menu to “On” (see page 35).</p>
Color balance is incorrect.	<ul style="list-style-type: none"> <li>• The picture has not been adjusted properly. <ul style="list-style-type: none"> <li>→ Adjust the picture (see page 29).</li> </ul> </li> <li>• The projector is set to the wrong color system. <ul style="list-style-type: none"> <li>→ Set “Color System” on the SET SETTING menu to match the color system being input (see page 33).</li> </ul> </li> </ul>
The picture is too dark.	<ul style="list-style-type: none"> <li>• Contrast or brightness has not been adjusted properly. <ul style="list-style-type: none"> <li>→ Adjust the contrast or brightness on the “Adjust Picture...” menu properly (see page 29).</li> </ul> </li> <li>• The lamp has burnt out or is dim. <ul style="list-style-type: none"> <li>→ Replace the lamp with a new one (see page 40).</li> </ul> </li> </ul>
The picture is not clear.	<ul style="list-style-type: none"> <li>• The picture is out of focus. <ul style="list-style-type: none"> <li>→ Adjust the focus (see page 21).</li> </ul> </li> <li>• Condensation has accumulated on the lens. <ul style="list-style-type: none"> <li>→ Leave the projector for about two hours with the power on.</li> </ul> </li> </ul>
The image extends beyond the screen.	<ul style="list-style-type: none"> <li>• The APA key has been pressed even though there are black edges around the image. <ul style="list-style-type: none"> <li>→ Display the full image on the screen and press the APA key.</li> <li>→ Adjust “Shift” on the INPUT SETTING menu properly (see page 31).</li> </ul> </li> <li>• This input signal cannot be projected as the frequency is out of the acceptable range of the projector. <ul style="list-style-type: none"> <li>→ Input a signal that is within the range of the frequency.</li> </ul> </li> <li>• The resolution setting of the output signal of the computer is too high. <ul style="list-style-type: none"> <li>→ Set the output setting to SVGA (VPL-ES7) or XGA (VPL-EX70/EX7) (see page 18).</li> </ul> </li> </ul>
The picture flickers.	<p>“Dot Phase” on the INPUT SETTING menu has not been adjusted properly.</p> <p>→ Adjust “Dot Phase” on the INPUT SETTING menu properly (see page 31).</p>

## Sound

Symptom	Cause and Remedy
No sound.	<ul style="list-style-type: none"> <li>• A cable is disconnected or the connections are wrong. <ul style="list-style-type: none"> <li>→ Check that the proper connections have been made (see page 18).</li> </ul> </li> <li>• The audio connecting cable used is incorrect. <ul style="list-style-type: none"> <li>→ Use a no-resistance stereo audio cable (see page 18).</li> </ul> </li> <li>• The sound is not adjusted properly. <ul style="list-style-type: none"> <li>→ Adjust the sound with the VOLUME +/- key on the Remote Commander or adjust “Volume” on the PICTURE SETTING menu (see page 30).</li> </ul> </li> </ul>



FixYourDLP.com  
Sponsored by DM

Discount-Merchants.com (800) 881-8860  
THE TRUSTED SOURCE FOR PROJECTOR LAMPS AND ACCESSORIES

## Remote Commander

Symptom	Cause and Remedy
The Remote Commander does not work.	The Remote Commander battery are dead. → Replace them with new battery (see page 16).

## Others

Symptom	Cause and Remedy
The control panel keys do not function.	The control panel keys are locked. → Unlock the control panel keys (see page 34).

## Indicators

Symptom	Cause and Remedy
The LAMP/COVER indicator flashes in orange. (Repetition rate of 2 flashes)	The lamp cover or the air filter cover is detached. → Attach the cover securely (see pages 41 and 42).
The LAMP/COVER indicator flashes in orange. (Repetition rate of 3 flashes)	<ul style="list-style-type: none"> <li>The lamp has reached the end of its life. → Replace the lamp (see page 40).</li> <li>The lamp has reached a high temperature. → Wait for 60 seconds to cool the lamp and then turn on the power again.</li> </ul>
I/⏻ key flashes in red. (Repetition rate of 2 flashes)	<ul style="list-style-type: none"> <li>The internal temperature is unusually high. → Check to see that nothing is blocking the ventilation holes.</li> <li>The projector is being used at a high altitude. → Ensure that “High Altitude Mode” in the INSTALL SETTING menu is set to “On.”</li> </ul>
I/⏻ key flashes in red. (Repetition rate of 4 flashes)	The fan is broken. → Consult with qualified Sony personnel.
I/⏻ key flashes in red. (Repetition rate of 6 flashes)	Unplug the AC power cord from the wall outlet after the I/⏻ key stops flashing, plug the power cord to the wall outlet, and then turn the projector on again. If the ON/STANDBY flashes in red and the problem persists, the electrical system has failed. → Consult with qualified Sony personnel.

Others

## Messages List

### Warning Messages

Use the list below to check the meaning of the messages displayed on the screen.

Message	Meaning and Remedy
Please replace the Lamp and clean the Filter.	<ul style="list-style-type: none"> <li>It is time to replace the lamp and clean the air filter. → Replace the lamp (see page 40) and clean the filter (see page 42).</li> <li>When this message appears even after replacing the lamp, the task has not been completed. → Perform the operation of steps <b>10</b> to <b>13</b> on page 41</li> </ul>

## Caution Messages

Use the list below to check the meaning of the messages displayed on the screen.

Message	Meaning and Remedy
Not applicable!	You have pressed the wrong key. → Press the appropriate key.
The panel keys are locked!	“Panel Key Lock” on the SET SETTING menu is set to “On.” → All the keys on the control panel of the projector are locked. Operate the projector with the keys on the Remote Commander (see page 34).



**Discount-Merchant.com (800) 281-8860**  
**THE TRUSTED SOURCE FOR PROJECTOR LAMPS AND ACCESSORIES**

# Specifications

## Optical characteristics

Projection system	3 LCD panels, 1 lens, projection system
LCD panel	VPL-EX70/EX7: 0.63-inch XGA panel, about 2,360,000 pixels (1024 × 768 × 3) VPL-ES7: 0.63-inch SVGA panel, about 1,440,000 pixels (800 × 600 × 3)
Lens	1.2 times zoom lens f 18.53 to 22.18 mm/F1.65 to 1.93
Lamp	190 W Ultra high pressure lamp
Projected picture size	40 to 300 inches
Light output <sup>1)</sup>	VPL-EX70: 2600 lm VPL-EX7/ES7: 2000 lm
<sup>1)</sup>	When the Lamp Mode is set to "High."

Throwing distance (When placed on the floor./ Adjuster not stretched, and the V Keystone function has been done.)

40-inch:	1.1 to 1.4 m (3.6 to 4.6 feet)
80-inch:	2.3 to 2.8 m (7.5 to 9.2 feet)
100-inch:	2.9 to 3.5 m (9.5 to 11.5 feet)
150-inch:	4.4 to 5.2 m (14.4 to 17.1 feet)
200-inch:	5.8 to 7.0 m (19.0 to 23.0 feet)
250-inch:	7.3 to 8.8 m (24.0 to 28.9 feet)
300-inch:	8.8 to 10.5 m (28.9 to 34.5 feet)

There may be a slight difference between the actual value and the design value shown above.

## Electrical characteristics

Color system	NTSC <sup>3.58</sup> /PAL/SECAM/ NTSC <sup>4.43</sup> /PAL-M/PAL-N/ PAL60 system, switched automatically/manually (NTSC <sup>4.43</sup> is the color system used when playing back a video recorded in NTSC on a NTSC <sup>4.43</sup> system VCR.)
Resolution	VPL-EX70/EX7: 750 horizontal TV lines (Video input) 1024 × 768 dots (RGB input)

VPL-ES7: 500 horizontal TV lines (Video input) 800 × 600 dots (RGB input) Acceptable computer signals <sup>2)</sup> fH: 19 to 92 kHz fV: 48 to 92 Hz (Maximum input signal resolution: SXGA+ 1400 × 1050 fV: 60 Hz)	
<sup>2)</sup>	Set the resolution and the frequency of the signal of the connected computer within the range of acceptable preset signals of the projector.

Applicable video signals	15 k RGB/component 50/60 Hz, Progressive component 50/60 Hz, DTV (480/60i, 575/50i, 480/60p, 575/50p, 720/60p, 720/50p, 1080/60i, 1080/50i), Composite video, Y/C video
Speaker	Monaural speaker system, 40 × 28.5 mm (1 <sup>5</sup> / <sub>8</sub> × 1 <sup>1</sup> / <sub>8</sub> inches)
Speaker output	1 W (max.) × 1

## Input/Output

VIDEO IN	VIDEO: phono type Composite video: 1 Vp-p ±2 dB sync negative (75 ohms terminated) S VIDEO: Y/C mini DIN 4- pintype Y (luminance): 1 Vp-p ±2 dB sync negative (75 ohms terminated) C (chrominance): burst 0.286 Vp-p ±2 dB (NTSC) (75 ohms terminated), burst 0.3 Vp-p ±2 dB (PAL) (75 ohms terminated)
INPUT A	RGB: HD D-sub15-pin (female) Analog RGB/component: R/R-Y: 0.7 Vp-p ±2 dB (75 ohms terminated) G: 0.7 Vp-p ±2 dB (75 ohms terminated) G with sync/Y: 1 Vp-p ±2 dB sync negative (75 ohms terminated) B/B-Y: 0.7 Vp-p ±2 dB (75 ohms terminated) HD: Horizontal sync input: TTL level, positive/negative VD: Vertical sync input: TTL level, positive/negative
INPUT B	RGB (VPL-EX70 only): HD D- sub15-pin (female) Analog RGB:

Others



R: 0.7 Vp-p  $\pm 2$  dB (75 ohms terminated)  
 G: 0.7 Vp-p  $\pm 2$  dB (75 ohms terminated)  
 B: 0.7 Vp-p  $\pm 2$  dB (75 ohms terminated)  
 HD: Horizontal sync input: TTL level, Positive/negative  
 VD: Vertical sync input: TTL level, positive/negative

HD D-sub 15 pin cable (1.8 m) (1)  
 (1-832-428-11, SONY)  
 Carrying case (1)  
 AC power cord (1)  
 Lens cap (1)  
 Operating Instructions (CD-ROM) (1)  
 Quick Reference Manual (1)  
 Safety Regulations (1)  
 Security Label (1)

#### AUDIO INPUT

Stereo minijack, 500 mVrms, input impedance 47 Kiloohms or more

#### OUTPUT

MONITOR OUT: HD D-sub15-pin (female)  
 R, G, B: Gain Unity: 75 ohms  
 HD, VD: 4 Vp-p (open), 1 Vp-p (75 ohms)  
 AUDIO OUT (variable out):  
 Stereo minijack  
 1 Vrms (When the volume is maximum and an input signal is 500 mVrms), output impedance 5 kilohms or less  
 REMOTE (VPL-EX70/EX7 only)  
 RS-232C: D-sub 9 pin

Design and specifications are subject to change without notice.

#### Note

Always verify that the unit is operating properly before use. SONY WILL NOT BE LIABLE FOR DAMAGES OF ANY KIND INCLUDING, BUT NOT LIMITED TO, COMPENSATION OR REIMBURSEMENT ON ACCOUNT OF THE LOSS OF PRESENT OR PROSPECTIVE PROFITS DUE TO FAILURE OF THIS UNIT, EITHER DURING THE WARRANTY PERIOD OR AFTER EXPIRATION OF THE WARRANTY, OR FOR ANY OTHER REASON WHATSOEVER.

### General

Dimensions 314  $\times$  109  $\times$  269 mm (12  $\frac{3}{8}$   $\times$  4  $\frac{3}{8}$   $\times$  10  $\frac{7}{8}$  inches) (w/h/d) (without projecting parts)  
 Mass VPL-EX70:  
 Approx. 3.0 kg (6 lb 10 oz)  
 VPL-EX7/ES7:  
 Approx. 2.9 kg (6 lb 6 oz)  
 Power requirements  
 VPL-EX70/EX7: AC 100 to 240 V, 2.6 to 1.1 A, 50/60 Hz  
 VPL-ES7: AC 100 to 240 V, 2.4 to 1.0 A, 50/60 Hz  
 Power consumption  
 VPL-EX70/EX7: Max.260 W (in standby: 3 W)  
 VPL-ES7: Max.240 W (in standby: 3 W)  
 Heat dissipation  
 884 BTU (VPL-EX70/EX7)  
 816 BTU (VPL-ES7)  
 Operating temperature  
 0°C to 35°C (32°F to 95°F)  
 Operating humidity  
 35% to 85% (no condensation)  
 Storage temperature  
 -20°C to +60°C (-4°F to +140°F)  
 Storage humidity  
 10% to 90%  
 Supplied accessories  
 Remote Commander (1)  
 Lithium battery CR2025 (1)

### Optional accessories

Projector Lamp  
 LMP-E191 (for replacement)

*Some of the items may not be available in some areas. For details, please consult your nearest Sony dealer.*



FixYourDLP.com

Discount-Merchant.com (800) 281-8860

THE TRUSTED SOURCE FOR PROJECTOR LAMPS AND ACCESSORIES

## Pin assignment

### INPUT A connector (HD D-sub 15-pin, female)

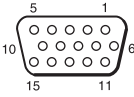

1	R/R-Y	9	Power supply input for DDC
2	G/Y	10	GND
3	B/B-Y	11	GND
4	RESERVE	12	DDC/SDA
5	GND	13	HD
6	GND (R)	14	VD
7	GND (G)	15	DDC/SCL
8	GND (B)		

### INPUT B connector (HD D-sub 15-pin, female) (VPL-EX70 only)

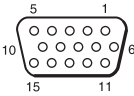

1	R	9	Power supply input for DDC
2	G	10	GND
3	B	11	GND
4	RESERVE	12	DDC/SDA
5	GND	13	HD
6	GND (R)	14	VD
7	GND (G)	15	DDC/SCL
8	GND (B)		

### RS-232C connector (D-sub 9 pin, female) (VPL-EX70/EX7 only)

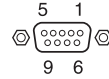

1	NC	6	NC
2	RXDA	7	RTS
3	TXDA	8	CTS
4	DTR	9	NC
5	GND		

Others



**Discount-Merchant.com (800) 281-8860**  
**THE TRUSTED SOURCE FOR PROJECTOR LAMPS AND ACCESSORIES**

## Preset signals

Memory No.	Preset signal		fH (kHz)	fV (Hz)	Sync
1	Video 60 Hz	60 Hz	15.734	59.940	–
2	Video 50 Hz	50 Hz	15.625	50.000	–
3	480/60i	480/60i	15.734	59.940	S on G/Y
4	575/50i	575/50i	15.625	50.000	S on G/Y
5	480/60p	480/60p (Progressive component NTSC)	31.470	60.000	S on G/Y
6	575/50p	575/50p (Progressive component PAL)	31.250	50.000	S on G/Y
7	1080/60i	1035/60i, 1080/60i	33.750	60.000	S on G/Y
8	1080/50i	1080/50i	28.130	50.000	S on G/Y
10	720/60p	720/60p	45.000	60.000	S on G/Y
11	720/50p	720/50p	37.500	50.000	S on G/Y
21	640 × 350	VGA mode 1	31.469	70.086	H-pos, V-neg
22		VGA VESA 85 Hz	37.861	85.080	H-pos, V-neg
23	640 × 400	PC-9801 Normal	24.823	56.416	H-neg, V-neg
24		VGA mode 2	31.469	70.086	H-neg, V-pos
25		VGA VESA 85 Hz	37.861	85.080	H-neg, V-pos
26	640 × 480	VGA mode 3	31.469	59.940	H-neg, V-neg
27		Macintosh 13"	35.000	66.667	H-neg, V-neg
28		VGA VESA 72 Hz	37.861	72.809	H-neg, V-neg
29		VGA VESA 75 Hz	37.500	75.000	H-neg V-neg
30		VGA VESA 85 Hz	43.269	85.008	H-neg V-neg
31		800 × 600	SVGA VESA 56 Hz	35.156	56.250
32	SVGA VESA 60 Hz		37.879	60.317	H-pos, V-pos
33	SVGA VESA 72 Hz		48.077	72.188	H-pos, V-pos
34	SVGA VESA 75 Hz		46.875	75.000	H-pos, V-pos
35	SVGA VESA 85 Hz		53.674	85.061	H-pos, V-pos
36	832 × 624	Macintosh 16"	49.724	74.550	H-neg, V-neg
37	1024 × 768	XGA VESA 60 Hz	48.363	60.004	H-neg, V-neg
38		XGA VESA 70 Hz	56.476	70.069	H-neg, V-neg
39	1152 × 864	XGA VESA 75 Hz	60.023	75.029	H-pos, V-pos
40		XGA VESA 85 Hz	68.677	84.997	H-pos, V-pos
41		SXGA VESA 70 Hz	63.995	70.019	H-pos, V-pos
42	1152 × 864	SXGA VESA 75 Hz	67.500	75.000	H-pos, V-pos
43		SXGA VESA 85 Hz	77.487	85.057	H-pos, V-pos
44	1152 × 900	Sunmicro LO	61.795	65.960	H-neg, V-neg

Memory No.	Preset signal		fH (kHz)	fV (Hz)	Sync
45	1280 × 960	SXGA VESA 60 Hz	60.000	60.000	H-pos, V-pos
46		SXGA VESA 75 Hz	75.000	75.000	H-pos, V-pos
47	1280 × 1024	SXGA VESA 60 Hz	63.974	60.013	H-pos, V-pos
48		SXGA VESA 75 Hz	79.976	75.025	H-pos, V-pos
49		SXGA VESA 85 Hz	91.146	85.024	H-pos, V-pos
50	1400 × 1050	SXGA+ 60 Hz	65.317	59.978	H-neg, V-pos
55	1280 × 768	WXGA 60Hz	47.776	59.870	H-neg, V-pos
56	1280 × 720	WXGA 60Hz	44.772	59.885	H-neg, V-pos
60	1360 × 768	1360 × 768/60	44.720	59.799	H-neg, V-pos
61	1440 × 900	1440 × 900/60	55.935	59.887	H-neg, V-pos
63	1280 × 800	1280 × 800/60	49.702	59.810	H-neg, V-pos

**Notes**

- When a signal other than the preset signals shown above is input, the picture may not be displayed properly.
- When an SXGA+ signal is input, the image may extend beyond the edges of the screen. In this case, input a signal with no black edges around the image, and disconnect and reconnect the cable or select the input signal by pressing the INPUT key.
- If the resolution of the input signal is different from the panel resolution, the input signal is not displayed in its own resolution, and letters or lines may be uneven.

Others



**Discount-Merchant.com (800) 281-8860**  
**THE TRUSTED SOURCE FOR PROJECTOR LAMPS AND ACCESSORIES**

# Installation Diagram

## Floor Installation (Front Projection)

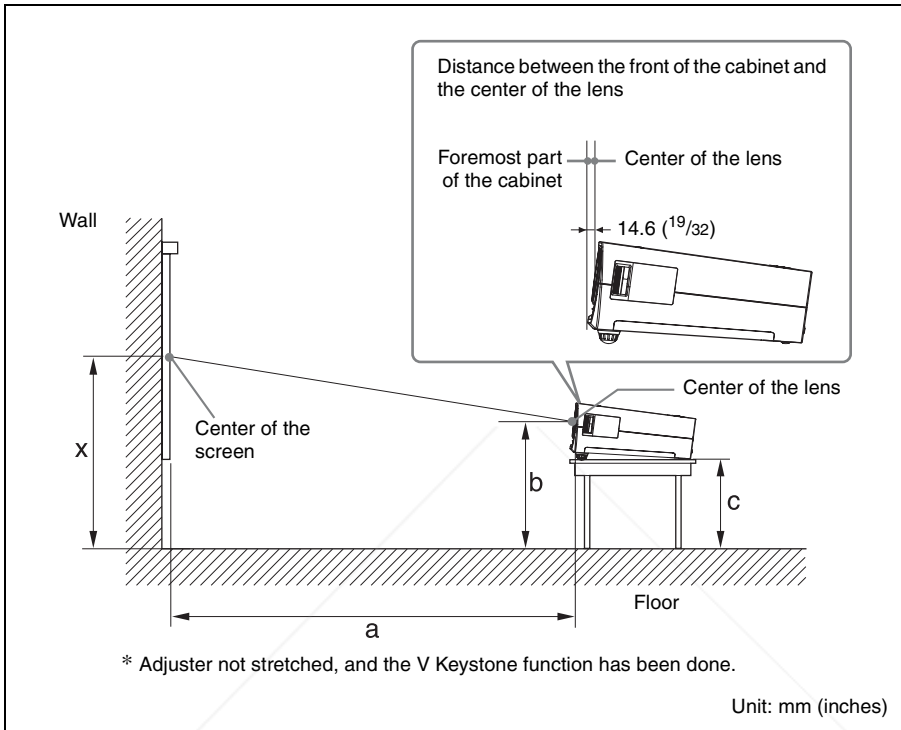

This section describes the examples of installing the projector on a desk, etc.

See the chart on page 53 concerning the installation measurements.

The alphabetical letters in the illustration indicate the distances below.

- a:** distance between the screen and the center of the lens
- b:** distance between the floor and the center of the lens
- c:** distance between the floor and the bottom of the adjusters of the projector
- x:** distance between the floor and the center of the screen (free)

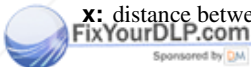

**Discount-Merchant.com (800) 281-8860**  
THE TRUSTED SOURCE FOR PROJECTOR LAMPS AND ACCESSORIES

PS		40	60	80	100	120	150	180	200	250	300
a	N	1180 (46 <sup>1</sup> / <sub>2</sub> )	1780 (70 <sup>1</sup> / <sub>8</sub> )	2390 (94 <sup>1</sup> / <sub>8</sub> )	2990 (117 <sup>3</sup> / <sub>4</sub> )	3600 (141 <sup>3</sup> / <sub>4</sub> )	4510 (177 <sup>5</sup> / <sub>8</sub> )	5410 (213 <sup>1</sup> / <sub>8</sub> )	6020 (237 <sup>1</sup> / <sub>8</sub> )	7530 (296 <sup>1</sup> / <sub>2</sub> )	9050 (356 <sup>3</sup> / <sub>8</sub> )
	M	1330 (52 <sup>3</sup> / <sub>8</sub> )	2020 (79 <sup>5</sup> / <sub>8</sub> )	2700 (106 <sup>3</sup> / <sub>8</sub> )	3380 (133 <sup>1</sup> / <sub>8</sub> )	4070 (160 <sup>3</sup> / <sub>8</sub> )	5090 (200 <sup>1</sup> / <sub>2</sub> )	6110 (240 <sup>5</sup> / <sub>8</sub> )	6800 (267 <sup>3</sup> / <sub>4</sub> )	8500 (334 <sup>3</sup> / <sub>4</sub> )	10210 (402 <sup>1</sup> / <sub>8</sub> )
b	Based on the calculation formula given below.										
c	Based on the calculation formula given below.										

$$a (N) = \{ (PS \times 29.376) \times 1.03 \} - 31.7$$

$$a (M) = \{ (PS \times 35.202) \times 0.97 \} - 31.7$$

$$b = x - \{ PS \times 5.055 + (a + 31.7) \times 0.1405 - 4.5 \}$$

$$c = x - \{ PS \times 5.055 + (a + 31.7) \times 0.1405 - 4.5 + 90.5 \}$$

The alphabetical letters in the charts and calculation methods indicate the following.

**PS:** projected image size measured diagonally (inches)

**a:** distance between the screen and the center of the lens

**b:** distance between the floor and the center of the lens

**c:** distance between the floor and the adjusters of the projector

**x:** free

**N:** minimum

**M:** maximum

## Ceiling Installation (Front Projection)

The unit is set so that the bottom is parallel to the ceiling. The V Keystone function has been done.

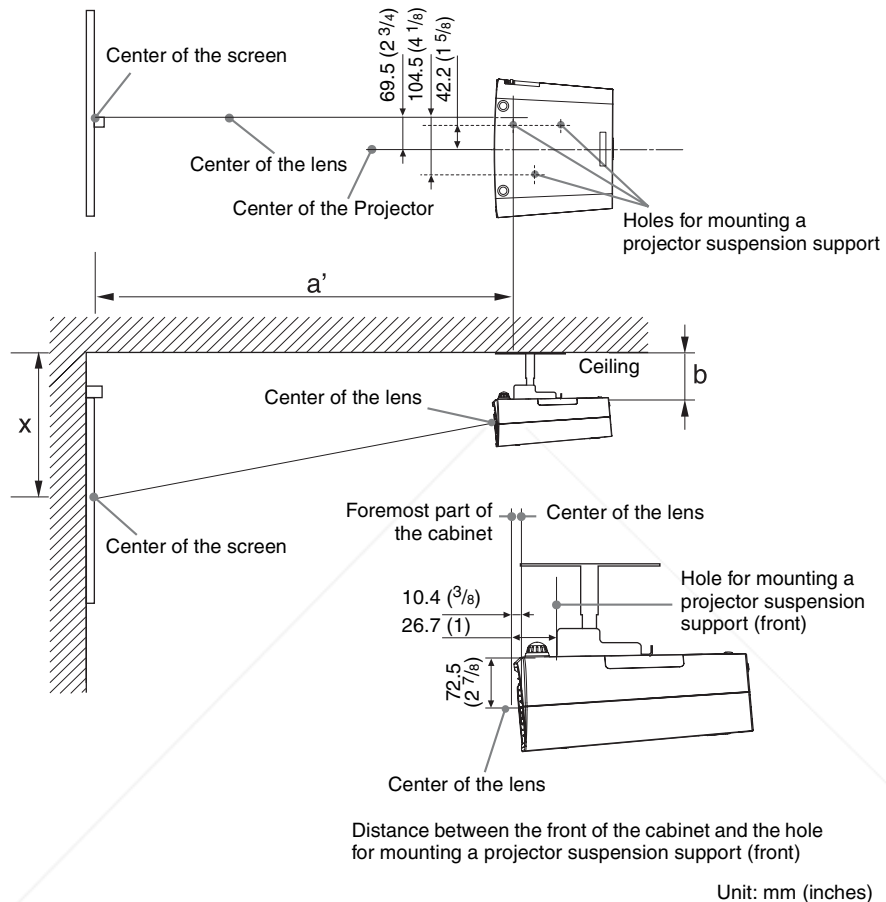

This section describes the examples for installing the projector on the ceiling.

When installing the projector on the ceiling, use a Projector Suspension Support recommended

by Sony.

For ceiling installation, ask for qualified Sony personnel.

See the chart on page 55 concerning the installation measurements.

The alphabetical letters in the illustrations indicate the distances below.

- a'**: distance between the hole (front) for mounting a projector suspension support on bottom surface of this projector and the center of the screen
- b**: distance between the hole (front) for mounting a projector suspension support on bottom surface of this projector and the ceiling
- x**: distance between the ceiling and the center of the screen

PS		40	60	80	100	120	150	180	200	250	300
a'	N	1200 (47 1/4)	1800 (70 7/8)	2410 (95)	3010 (118 5/8)	3620 (142 5/8)	4530 (178 3/8)	5440 (214 1/4)	6040 (237 7/8)	7560 (297 3/4)	9070 (357 1/4)
	M	1350 (53 1/4)	2040 (80 3/8)	2720 (107 1/8)	3410 (134 3/8)	4090 (161 1/8)	5120 (201 5/8)	6140 (241 7/8)	6830 (269)	8540 (336 3/8)	10250 (403 5/8)
x	Based on the calculation formula given below.										
b	Free										

$$a'(N) = \{(PS \times 29.415) \times 1.03\} - 32.0 + 16.4$$

$$a'(M) = \{(PS \times 35.283) \times 0.97\} - 32.0 + 16.4$$

$$x = b + \{PS \times 5.073 + (a' + 32.0 - 16.4) \times 0.07344 - 2.3 + 72.5\}$$

The alphabetical letters in the charts and calculation methods indicate the following.

**PS:** projected image size measured diagonally (inches)

**a':** distance between the hole (front) for mounting a projector suspension support on bottom surface of this projector and the center of the screen

**b:** distance between the projector suspension support mounting surface on bottom of this projector and the ceiling

**x:** distance between the center of the screen and the ceiling

**N:** minimum

**M:** maximum



# Dimensions

## Front

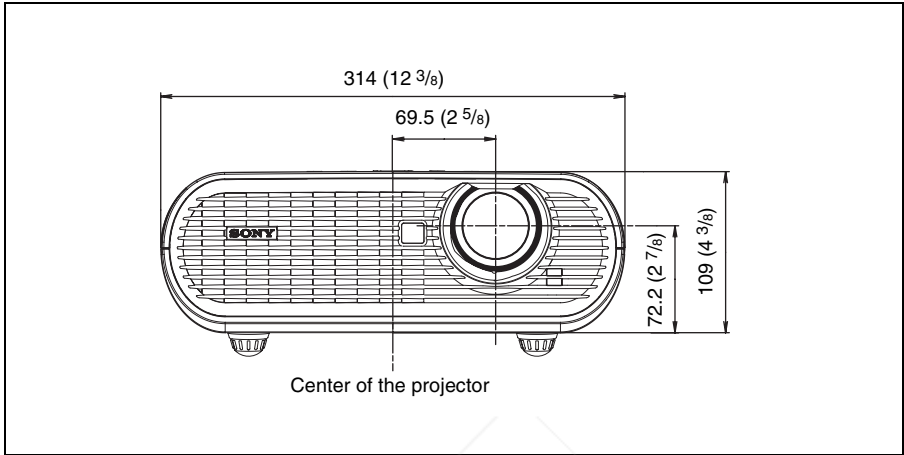

Unit: mm (inches)

## Side

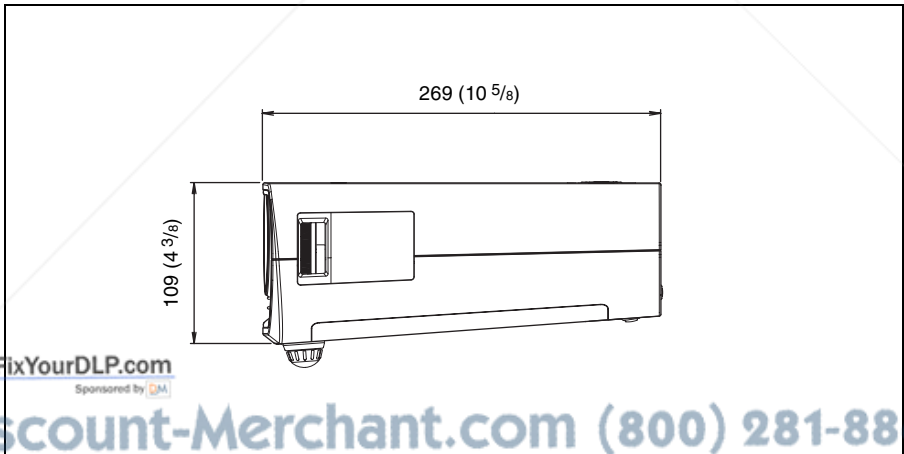

Unit: mm (inches)

FixYourDLP.com  
Sponsored by DM

Discount-Merchant.com (800) 281-8860

THE TRUSTED SOURCE FOR PROJECTOR LAMPS AND ACCESSORIES

Top

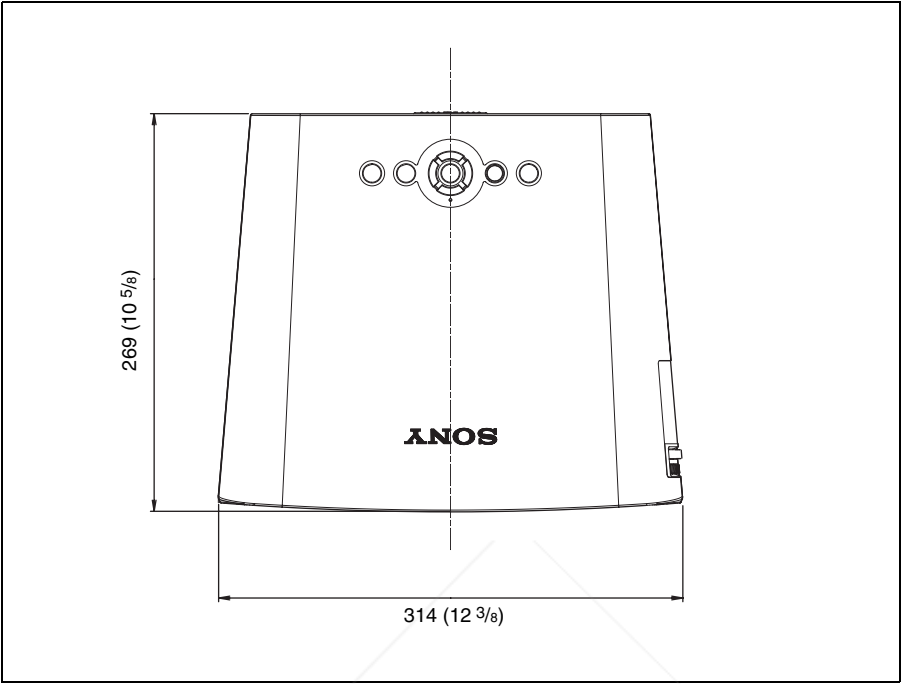

Unit: mm (inches)

Others

 **FixYourDLP.com**  
Sponsored by 

**Discount-Merchant.com (800) 281-8860**  
**THE TRUSTED SOURCE FOR PROJECTOR LAMPS AND ACCESSORIES**

# Index

## A

Adjust Picture .....	29
Air filter .....	42
Aspect .....	31, 32
Auto Input Search .....	33

## B

Background .....	36
Batteries .....	16
Brightness .....	29

## C

CC Display .....	34
Color .....	29
Color System .....	33
Color Temp. ....	30
Connecting a computer .....	18
Connecting a VCR .....	19
Contrast .....	29

## D

DDE .....	30
Digital Zoom function .....	25
Direct Power On .....	36
Direct power On/Off function .....	25
Dot Phase .....	31

## F

fH (Horizontal Frequency) .....	38
fV (Vertical Frequency) .....	38

## G

Gamma Mode .....	29
------------------	----

## H

H Size .....	31
High Altitude Mode .....	36
Hue .....	29

## I

Image Flip .....	36
Input-A Signal Sel. ....	33
Installation .....	17
notes .....	6
unsuitable conditions .....	7

unsuitable installation .....	6
-------------------------------	---

## L

Lamp Mode .....	36
Lamp replacement .....	40
Lamp Timer .....	38
Lamp Timer Reset .....	34
Language .....	35
selecting the menu language .....	23
Lens .....	11
Location and function of controls	
connector panel .....	14
control panel .....	12
rear/bottom .....	10
Remote Commander .....	15
top/right side/front .....	10

## M

Menu	
clearing the menu display .....	28
INFORMATION Menu .....	38
INPUT SETTING menu .....	31
INSTALL SETTING menu .....	36
MENU SETTING menu .....	35
PICTURE SETTING menu .....	29
SET SETTING menu .....	33
using a menu .....	27
Menu Position .....	35
Message List	
caution .....	46
warning .....	45

## O

Optional accessories .....	48
----------------------------	----

## P

Panel Key Lock .....	34
Picture Mode .....	29
Pin assignment .....	49
Power	
turn on .....	20
Power Saving .....	34
Presentation .....	25
Preset Memory No. ....	32
Projecting .....	20

## R

Remote Commander .....	15
front remote control detector .....	10
location and function of controls .....	15

Reset  
 resetting an item .....28  
 RS-232C connector .....49

**S**

Screen size ..... 17  
 Security bar ..... 11  
 Security Lock ..... 24, 36  
 Security lock ..... 11  
 Sharpness .....29  
 Shift ..... 31  
 Smart APA .....33  
 Specifications .....47  
 Start Up Image .....35  
 Status .....35  
 Supplied accessories .....48

**T**

Troubleshooting .....43

**V**

V Keystone .....36  
 Volume .....30

Others



**Discount-Merchant.com (800) 281-8860**  
**THE TRUSTED SOURCE FOR PROJECTOR LAMPS AND ACCESSORIES**



**Discount-Merchant.com (800) 281-8860**  
**THE TRUSTED SOURCE FOR PROJECTOR LAMPS AND ACCESSORIES**



# Disclaimer

This user manual is provided as a free service by FixYourDLP.com. FixYourDLP is in no way responsible for the content of this manual, nor do we guarantee its accuracy. FixYourDLP does not make any claim of copyright and all copyrights remain the property of their respective owners.

About FixYourDLP.com

FixYourDLP.com (<http://www.fixyourdpl.com>) is the World's #1 resource for media product news, reviews, do-it-yourself guides, and manuals.

Informational Blog: <http://www.fixyourdpl.com>

Video Guides: <http://www.fixyourdpl.com/guides>

User Forums: <http://www.fixyourdpl.com/forum>

FixYourDLP's Fight Against Counterfeit Lamps:

<http://www.fixyourdpl.com/counterfeits>

## Sponsors:

RecycleYourLamp.org – Free lamp recycling services for used lamps:

<http://www.recycleyourlamp.org>

Lamp Research - The trusted 3rd party lamp research company:

<http://www.lampresearch.com>

Discount-Merchant.com – The worlds largest lamp distributor:

<http://www.discount-merchant.com>



**FixYourDLP.com**

Sponsored by 