



Disclaimer

This user manual is provided as a free service by FixYourDLP.com. FixYourDLP is in no way responsible for the content of this manual, nor do we guarantee its accuracy. FixYourDLP does not make any claim of copyright and all copyrights remain the property of their respective owners.

About FixYourDLP.com

FixYourDLP.com (<http://www.fixyourdpl.com>) is the World's #1 resource for media product news, reviews, do-it-yourself guides, and manuals.

Informational Blog: <http://www.fixyourdpl.com>

Video Guides: <http://www.fixyourdpl.com/guides>

User Forums: <http://www.fixyourdpl.com/forum>

FixYourDLP's Fight Against Counterfeit Lamps:

<http://www.fixyourdpl.com/counterfeits>

Sponsors:

RecycleYourLamp.org – Free lamp recycling services for used lamps:

<http://www.recycleyourlamp.org>

Lamp Research - The trusted 3rd party lamp research company:

<http://www.lampresearch.com>

Discount-Merchant.com – The worlds largest lamp distributor:

<http://www.discount-merchant.com>



FixYourDLP.com



Sponsored by 

EPSON®

User's Guide







MM PROJECTOR
ULTI EDIA

EMP-S3

 FixYourDLP.com
Sponsored by 

Discount-Merchant.com (800) 281-8850
THE TRUSTED SOURCE FOR PROJECTOR LAMPS AND ACCESSORIES



	Indicates procedures which may result in damage or injury if sufficient care is not taken.
	Indicates additional information and points which may be useful to know regarding a topic.
	Indicates a page where useful information regarding a topic can be found. Click on the page number to display that page.
	Indicates that an explanation of the underlined word or words in front of this symbol appears in the glossary of terms. Click the underlined word or words to display the corresponding entry in the "Glossary" section of the "Appendices".  p.67
	Indicates operating methods and the order of operations. The procedure indicated should be carried out in the order of the numbered steps.
[(Name)]	Indicates the name of the buttons on the control panel or the remote control. Example: [Esc] button
" (Menu Name) "	Indicates configuration menu items. Example: "Image" - "Brightness"

When "unit" or "projector" appears in the text of this *User's Guide*, it may refer to items which are accessories or optional equipment in addition to the main projector unit itself.

Projector Features.....	4
Part Names and Functions.....	6
Front/Top	6
Control Panel	7
Rear	8
Base.....	9
Remote Control.....	10

Adjusting and changing the image

Adjusting the Image Quality	12
Adjusting Computer Images and RGB Video Images.....	12
Selecting the Projection Quality (Color Mode)	14
Adjusting the Projection Position (Image Shift)	16
Adjusting the Volume	17
Changing the Projected Image (Source Search).....	18
Automatically Detect Incoming Signals and Change the Projected Image (Source Search).....	18
Changing Directly from the Remote Control.....	18

Useful Functions

Functions for Enhancing Projection	20
Pausing the Image and Sound (A/V Mute)	20
Freezing the Image (Freeze).....	20
Changing the Aspect Ratio (Resizing)	21
Displaying the Pointer (Pointer).....	21
Enlarging Part of the Image (E-Zoom)	22
Using the Remote Control to Operate the Mouse Pointer (Wireless Mouse).....	23
Security functions.....	26
Preventing theft (Password Protect).....	26
Operation Button Lock Function.....	29

Configuration Menu

Using the Configuration Menu	32
List of Functions.....	33
"Image" Menu	33
"Signal" Menu	34
"Settings" Menu	35
"Extended" Menu	36
"Info" Menu.....	38
"Reset" Menu	39

Troubleshooting

Using the Help	41
Problems Solving	43
Reading the Indicators.....	43
When the Indicators Provide No Help	46



Appendices

Installation	55
Setting Up the Projector	55
Maintenance	56
Cleaning	56
Replacing Consumables	57
Saving a User's Logo	63
Checking Projected Images on an External Monitor (Monitor Output)	65
Optional Accessories and Consumables	66
Glossary	67
List of ESC/VP21 Commands	69
Command List	69
Cable Layouts	69
USB Connection Setup	70
List of Supported Monitor Displays	71
Specifications	72
Appearance	73
Index	74

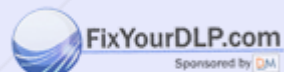

Discount-Merchant.com (800) 281-8860
THE TRUSTED SOURCE FOR PROJECTOR LAMPS AND ACCESSORIES



Colour Mode

You can enjoy images of "Photos", "Presentations", "Games", and so on, in the optimum colour tone by choosing the most suitable mode for your surroundings. [p.14](#)

Direct Power On & Instant Off

The direct power on function means you can turn the projector on simply by plugging the power cable into the electrical outlet. [p.37](#)
Also, with the instant-off function you can finish quickly by unplugging the power cable immediately after use.

Ease of Use

■ Source search allows you to easily choose the image to project. Simply by pressing the "Source Search" button, the connected picture signal is automatically detected and projected.

■ Easy to use, big button control panel

For ease of use, buttons are classified and arranged according to their projection and adjustment functions. [p.7](#)

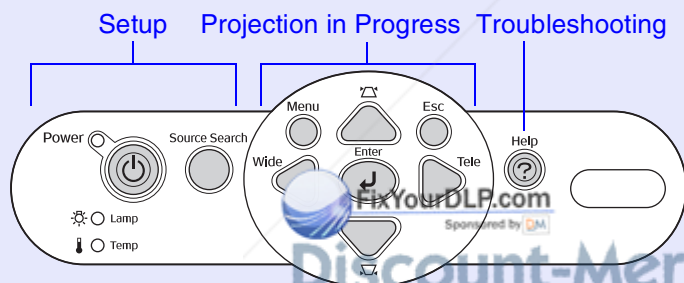

■ A single foot design means you do not have to make any difficult leveling adjustments

You can easily make height adjustments with one hand. [Setup Guide](#)

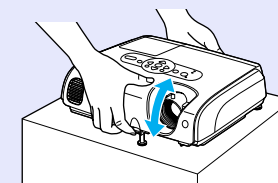

■ The help performs problem solving in a dialog format. Check the answer to the question to solve your projection problems.

[p.41](#)

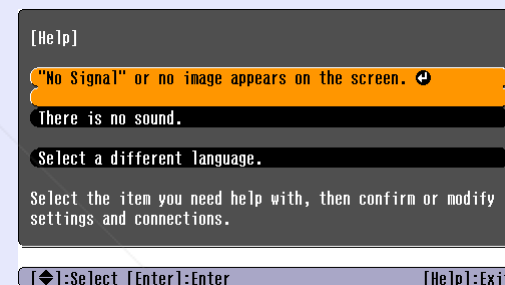

■ When you turn the projector power on and off a "Beep" sounds. A "Beep" sounds when the power is turned ON, after the cooling down period has finished the confirmation buzzer beeps twice. Once you hear the confirmation buzzer beep twice, you can unplug the power cable.

Image Shift

When you cannot setup this projector directly in front of the screen, the projection position can be finely tuned without moving this projector.

 [p.16](#)

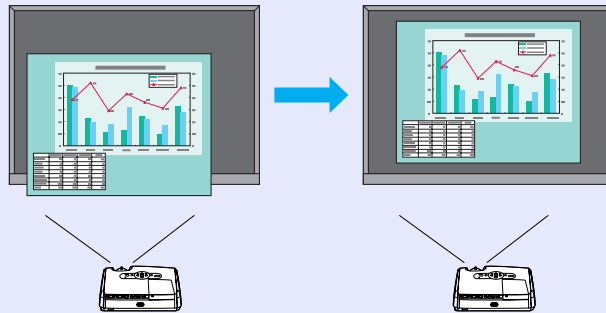

Security Function

■ Manage users with password protect

You can set up a password to restrict the use of the projector.  [p.26](#)

■ Operation lock stops the use of all control panel buttons except for the Power button

This can prevent your settings being changed by accident or on purpose, when using the projector at an event, at a school, and so on.  [p.29](#)

Front/Top

- **Lamp cover**  [p.58](#)

Open this cover when replacing the projector's lamp.

- **Air exhaust vent**

CAUTION Do not touch the exhaust vent immediately after projecting, or while projecting, since it becomes hot.

- **Front adjustable foot**

 [Setup Guide](#)

Extend and retract to adjust the projection angle when the projector is placed on a surface such as a shelf.

- **Foot adjust lever**

 [Setup Guide](#)

Pull out the foot lever to extend and retract the front foot.

- **Security lock**  [p.67](#)

- **Control panel**  [p.7](#)

- **Focus ring**  [Setup Guide](#)

Adjusts the image focus.

- **Remote control light-receiving area**  [Setup Guide](#)

Receives signals from the remote control.

- **Lens cover**

Attach when not using the projector to prevent the lens from becoming dirty or damaged.

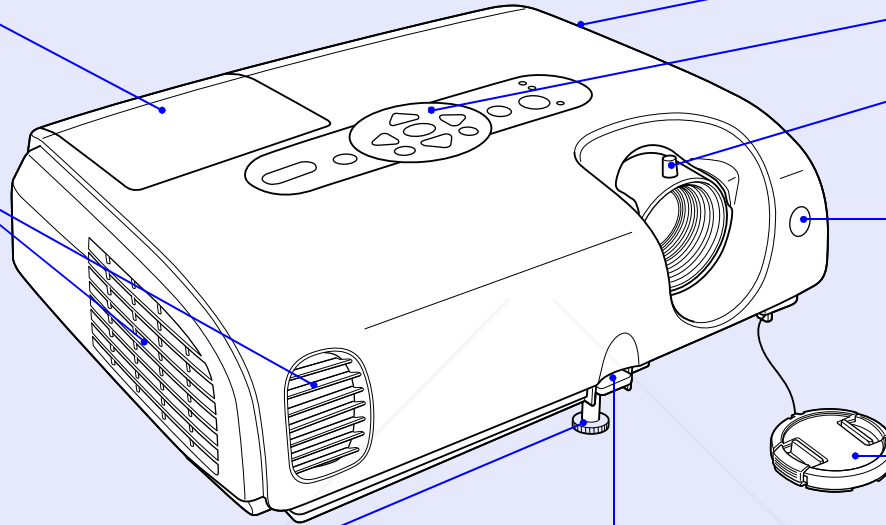

Control Panel

- **[Menu] button** [p.32](#)

Displays and closes the configuration menu.

- **[Power] button** [Setup Guide](#)

Turns the projector power on or off.

- **Indicator states** [p.43](#)

The colour of the indicators and whether they are flashing or lit shows the state of this projector.

Lamp
 Temp

- **[Source Search] button** [p.18](#)

The input source is automatically searched for in the following order, and the input image from the connected equipment is projected.

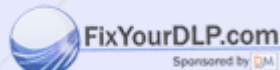
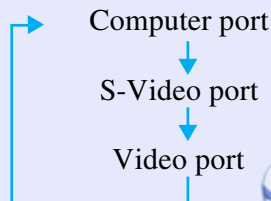

Discount-Merchants.com (800) 281-8860
 THE TRUSTED SOURCE FOR PROJECTOR LAMPS AND ACCESSORIES

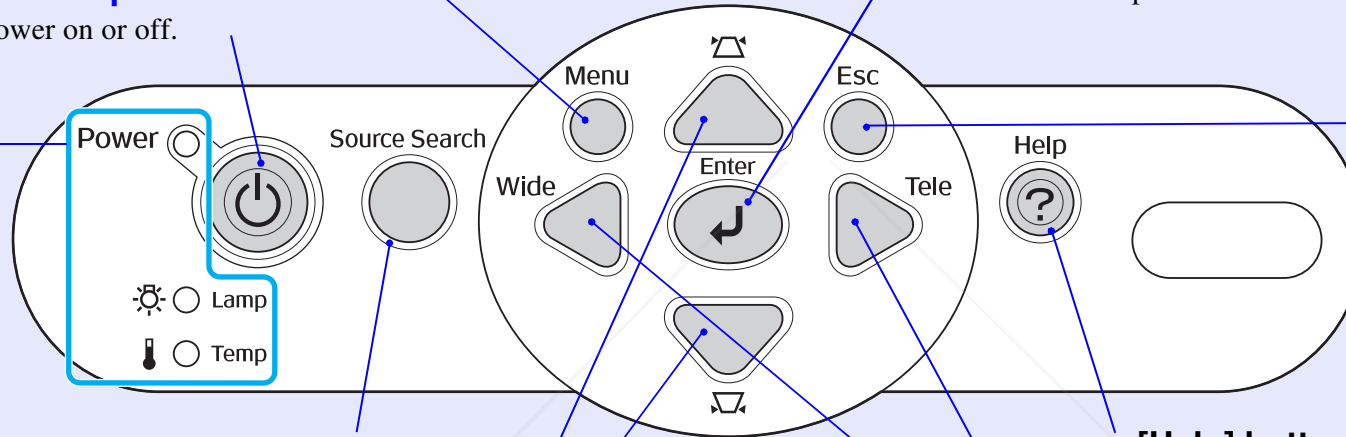

- **[Enter] button** [p.12, p.32](#)

Automatically adjusts analogue RGB images from computers and RGB video images to the optimum images.
 If a configuration menu or help screen is displayed, it accepts and enters the current selection.

- **[Esc] button** [p.32](#)

Stops the current function. Displays the previous screen or menu while viewing a configuration menu.

- **[Help] button** [p.41](#)

Displays and closes the help, which shows solutions if a problem occurs.

- **[Wide] [Tele] button** [Setup Guide, p.32](#)

Adjusts the image size. If a configuration menu or help screen is displayed, it selects menu items and setting values.

- **[△] [▽] button** [Setup Guide, p.32](#)

Press to correct keystone distortion. If a configuration menu or help screen is displayed, it selects menu items and setting values.

Rear

- **Computer port**  [Setup Guide](#)

Inputs analogue RGB video signals from a computer and RGB video signals and [component video](#) signals from other video sources.

- **Monitor Out port**  [p.65](#)

Outputs the projected computer's analogue RGB signals or RGB video signals to an external monitor from the source that is connected to the Computer port. This feature is not available for video equipment signals.

- **Power inlet**  [Setup Guide](#)

Connects to the power cable.

- **Rear adjustable foot**

- **S-Video port**  [Setup Guide](#)

Inputs [S-Video](#) signals to the projector from other video sources.

- **Video port**  [Setup Guide](#)

Inputs [composite video](#) signals to the projector from other video sources.

- **USB port**  [p.23, p.69](#)

Connects the projector to a computer via the [USB](#) cable when using the wireless mouse function.

Computer images cannot be projected by using the USB cable to connect the computer.

- **Remote control light-receiving area**  [Setup Guide](#)

Receives signals from the remote control.

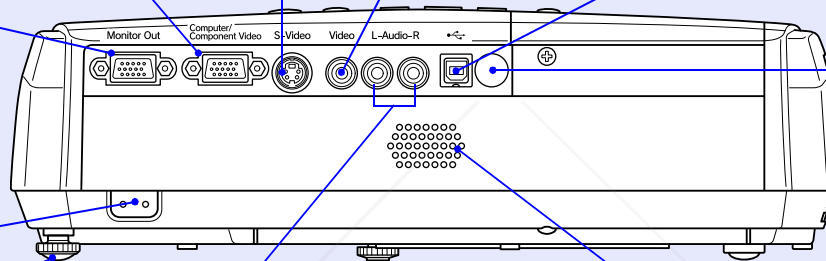

- **Audio input**  [Setup Guide](#)

Input audio signals from connected external equipment.

When you are connecting two or more pieces of external equipment that use the same input port, you need to disconnect one before connecting the other, or use an audio selector.





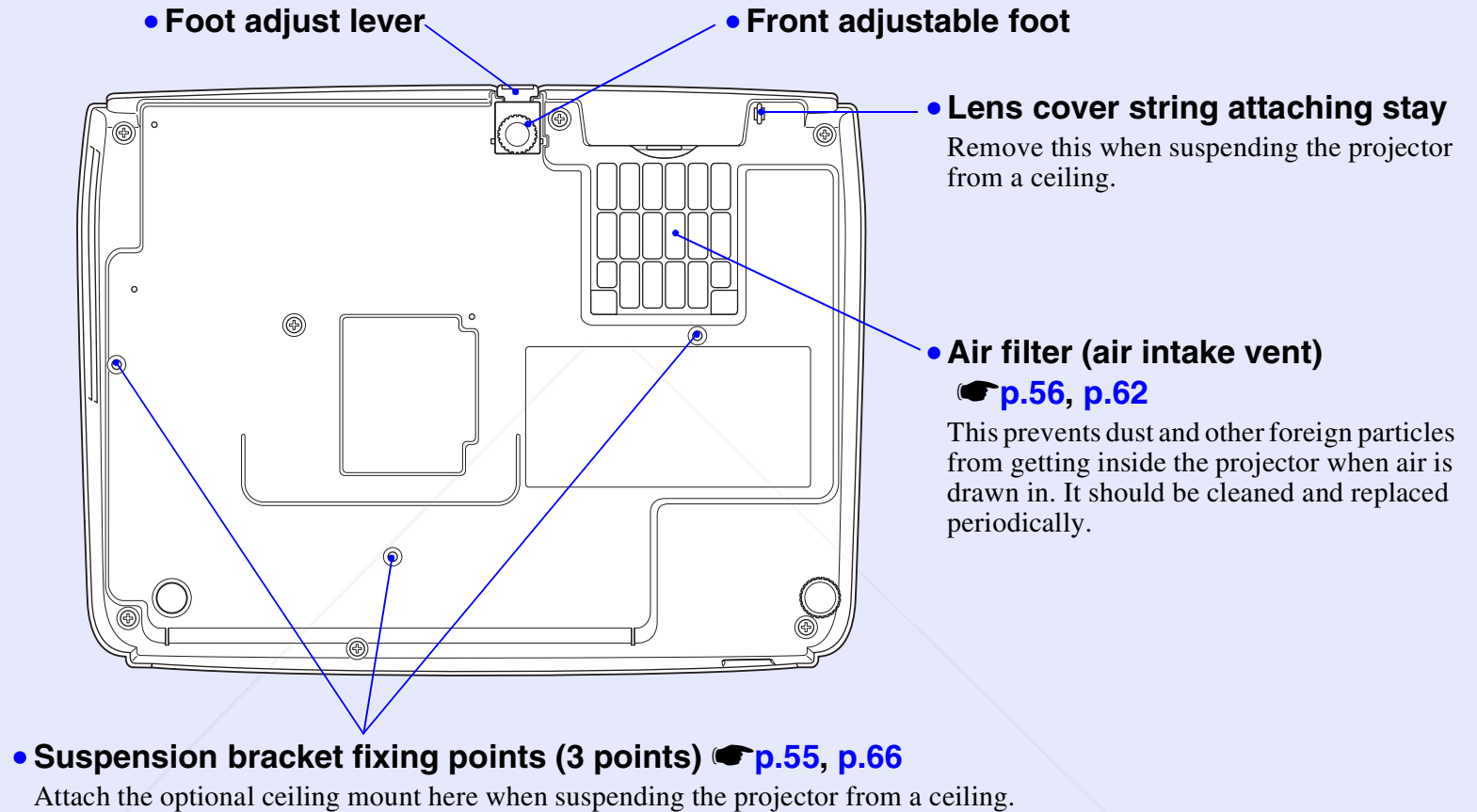





- **Speaker**

Base













Remote Control

If you position the  over the button icon or button name, a description of that button will appear.

- [Page down] [Page up] buttons  [p.24](#)
- [E-Zoom] button (⊕) (⊖)  [p.22](#)
- [Enter] button  [p.24, p.32](#)
- [Esc] button  [p.24, p.32](#)
- [Pointer] button  [p.21](#)
- [A/V Mute] button  [p.20](#)
- [Computer] button  [p.18](#)
- [S-Video] button  [p.18](#)
- [Video] button  [p.18](#)
- [Auto] button  [p.12](#)



- Remote control light-emitting area  [Setup Guide](#)
- [Power] button  [Setup Guide](#)
- [⊕/⊖] buttons  [p.24, p.32](#)
- [Freeze] button  [p.20](#)
- [Num] button  [p.26](#)
- [Color Mode] button  [p.14](#)
- [Menu] button  [p.32](#)
- [Resize] button  [p.21](#)
- [Help] button  [p.41](#)
- [Volume] buttons  [p.17](#)
- [Search] button  [p.18](#)
- Numeric buttons  [p.26](#)

Adjusting and changing the image

This chapter explains how to adjust the quality of the image, the volume, the colour mode selection and so on, and also how to change the image.

Adjusting the Image Quality	12	Adjusting the Projection Position (Image Shift)	16
• Adjusting Computer Images and RGB Video Images.....	12	Adjusting the Volume.....	17
• Automatic Setup	12	Changing the Projected Image (Source Search).....	18
• Adjusting the Tracking	12	• Automatically Detect Incoming Signals and Change the Projected Image (Source Search).....	18
• Adjusting the Sync.....	13	• Changing Directly from the Remote Control.....	18
• Selecting the Projection Quality (Color Mode)	14		

Adjusting Computer Images and RGB Video Images

Automatic Setup

Automatic setup detects analogue RGB signals coming from a connected computer, and automatically adjusts these signals so that the optimum images can be obtained.

Automatic setup involves adjustment of the following three items: [Tracking](#), Position and [Sync \(synchronisation\)](#).

If "Auto Setup" in the "Signal" menu is set to "OFF", automatic setup is not carried out. In this case, press the [Auto] button on the remote control or the [Enter] button on the projector's control panel to make the adjustment while computer or RGB video images are being projected.

Using the remote control

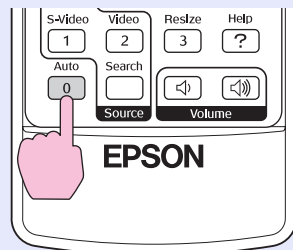

Using the control panel

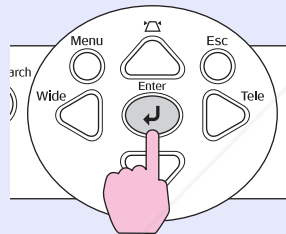

TIP

- If you press the [Auto] button on the remote control, or the [Enter] button on the control panel, while performing other functions such as E-zoom or Freeze, these functions are canceled and then the adjustment is made.
- Sometimes the signal may not be adjusted correctly depending on the type of computer or RGB video signals being input. In such cases, use the configuration menu commands to adjust the tracking and sync settings manually. [p.13](#)

Adjusting the Tracking

If vertical stripes appear in the projected computer or RGB video images, and this cannot be fixed using automatic setup, you will need to adjust the [Tracking](#) manually using the following procedure.

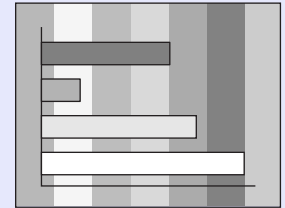

PROCEDURE



Select "Signal" from the configuration menu, and then select "Tracking".

For details on this operation, refer to "Using the Configuration Menu". [p.32](#)

Check the buttons you can use and the operations they perform in the guide at the bottom of the screen.

Using the remote control

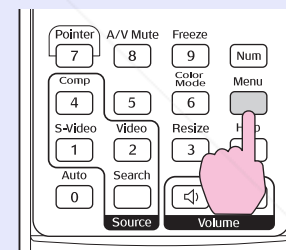

Using the control panel

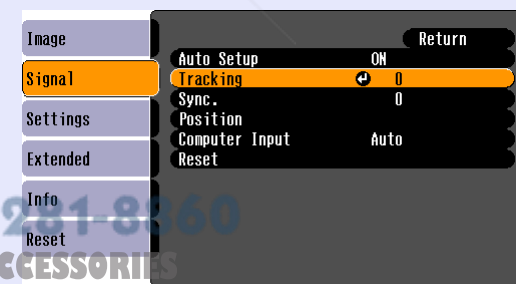
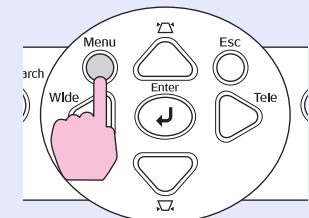

[Esc]:Return [◀]:Select [Enter]:Enter [Menu]:Exit



- Adjust the tracking until the vertical stripes disappear from the image.

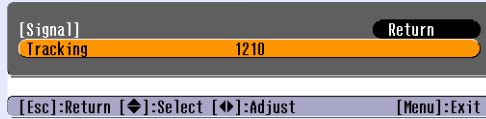

Using the remote control

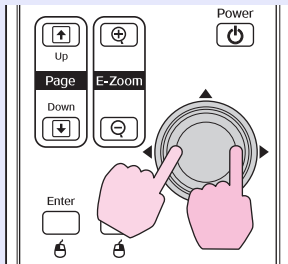

Using the control panel

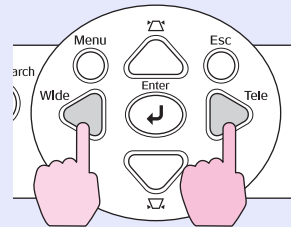

The tracking value increases or decreases each time a button is pressed.

- Press the [Menu] button to exit the configuration menu.



The image will flash when continuous tracking adjustment is carried out, but this is normal.

Adjusting the Sync

If flickering, fuzziness or interference appear in computer or RGB video images, and this cannot be fixed using automatic setup, you will need to adjust the [Sync \(synchronisation\)](#) manually using the following procedure.

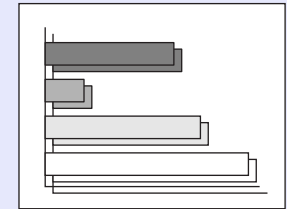

PROCEDURE

- Select "Signal" from the configuration menu, and then select "Sync."

For details on this operation, refer to "Using the Configuration Menu". [p.32](#)

Check the buttons you can use and the operations they perform in the guide at the bottom of the screen.

Using the remote control

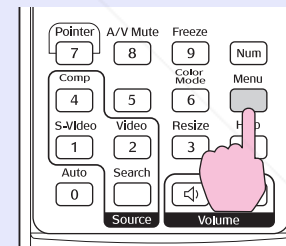

Using the control panel

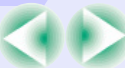
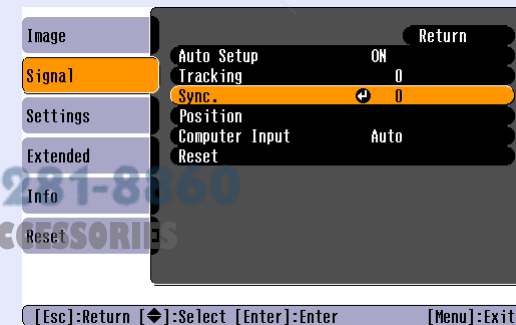
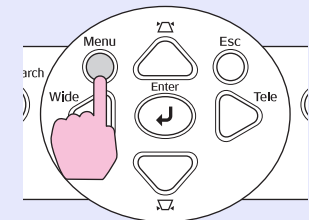

- 2 Adjust the synchronization until the horizontal noise disappears from the image.

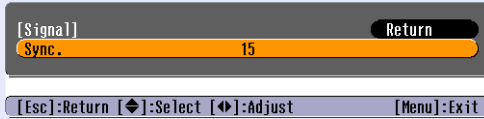

Using the remote control

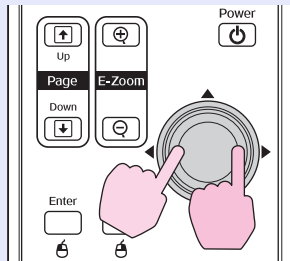

Using the control panel

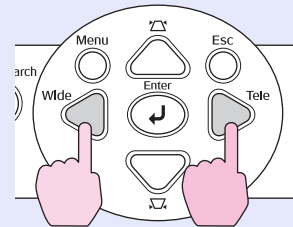

The sync value increases or decreases each time a button is pressed.

- 3 Press the [Menu] button to exit the configuration menu.



TIP

- If you adjust the sync without adjusting the **tracking** first, it will not be possible to get the best adjustment results. Incorrect tracking adjustment may not be noticeable with some types of picture. However, pictures with lots of lines and shading will tend to show incorrect tracking adjustments more clearly, so check the tracking adjustment first.
- Flickering and fuzziness may also occur when the brightness, **contrast**, sharpness, zoom, and keystone correction settings are adjusted.

Selecting the Projection Quality (Color Mode)

The following seven preset colour modes are available for use depending on the characteristics of the images that are being projected. You can easily obtain the optimum image quality simply by selecting the colour mode that corresponds to the projected images. The brightness of the images will vary depending on which colour mode is selected.

Mode	Application
Photo	(When computer and RGB video images are being input) The images are vivid and brought into contrast. Ideal for projecting still pictures, such as photos, in a bright room.
Sports	(When component video, S-video, or composite video images are being input) The images are vivid and brought to life. Ideal for watching TV programmes and so on in a bright room.
Presentation	Ideal for giving presentations in a bright room
Theatre	Gives images a natural tone. Ideal for watching films in a dark room.
Game	Excels at emphasising dark gradations. Ideal for playing video games in a bright room.
sRGB	Ideal for images that conform to the sRGB colour standard
Blackboard	Even if you are projecting onto a blackboard (green board), this setting gives your images a natural tint, just like when projecting onto a screen

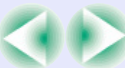

PROCEDURE

Remote control

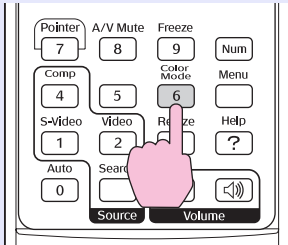

Each time you press the button, the colour modes change in the following order.

The current setting appears in the top-right corner of the screen each time the colour mode is changed. While the colour mode name is displayed on the screen, it does not change to the next colour mode setting unless you press the button.

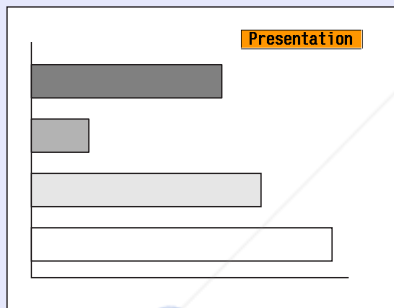
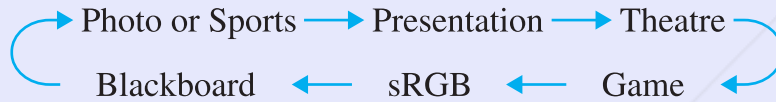

TIP

The colour mode can also be set using the "Color Mode" command in the "Image" menu. [p.33](#)



FixYourDLP.com

Sponsored by DM

DiscountMerchant.com (800) 281-8860
THE TRUSTED SOURCE FOR PROJECTOR LAMPS AND ACCESSORIES



Adjusting the Projection Position (Image Shift)



When you cannot setup this projector directly in front of the screen, the projection position can be finely tuned without moving this projector.

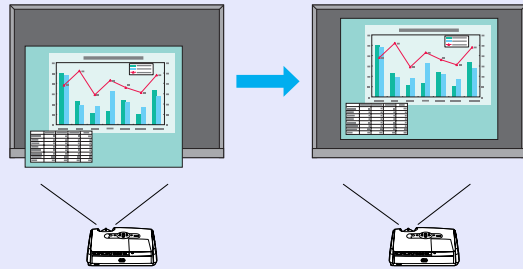

PROCEDURE

- 1 Using the button on the projector, perform zoom adjustment or keystone correction.

👉 [Setup Guide](#)

The Image Shift adjustment screen is displayed after you finish making adjustments.

- 2 Adjust projection position.

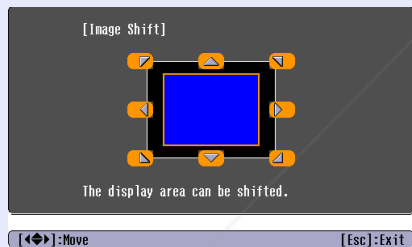

Using the Remote Control

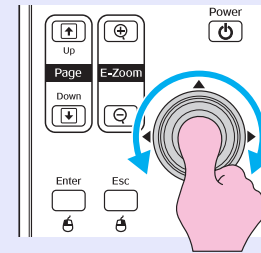

Using the Control Panel

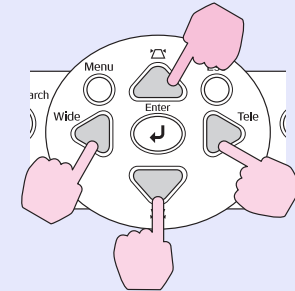

- 3 Press the [Esc] button to close the adjustment screen.

The screen closes automatically if no operations are performed for about 10 seconds.



TIP

- *The projection position cannot be adjusted when zoom is set to maximum "wide".*
- *Even if you turn the power supply off, the "Image Shift" settings you make are kept. When either the projector position or the angle of the projector is changed, you can readjust or perform the following operations.*

Control Panel

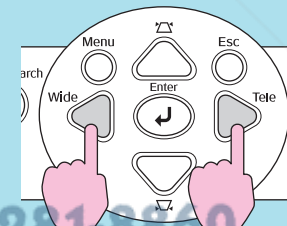

Press and hold down the [Wide] and [Tele] buttons for more than one second.

- *You can also make adjustments from the configuration menu. 👉 p.35*

The volume of the projector's built-in speaker can be adjusted as follows.

PROCEDURE

Remote control

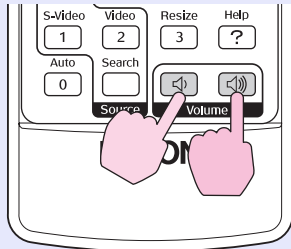

When the button is pressed to the [🔊] side, the volume increases, and when it is pressed to the [🔊] side, the volume decreases. The volume gauge appears on the screen when the volume is being adjusted.



TIP

- *If the value displayed in the gauge on the screen stops changing when the volume is being adjusted, it indicates that the limit for volume adjustment has been reached.*
- *The volume can also be adjusted using the configuration menu. [p.35](#)*

Automatically Detect Incoming Signals and Change the Projected Image (Source Search)

The picture signal input from the connected equipment is automatically detected and projected.

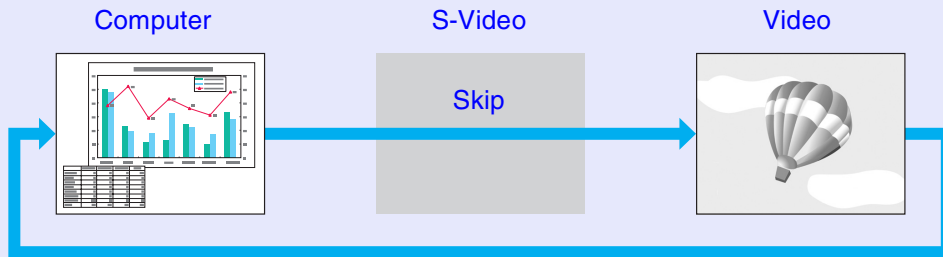

PROCEDURE

1 Perform the Source Search.

Using the Remote Control

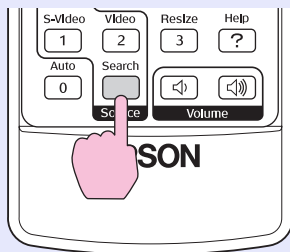

Using the Control Panel

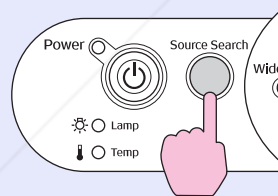

2 The screen being searched for is displayed, and then the image is projected.

When two or more pieces of equipment are connected, press the [Source Search] button until the target image is projected.



TIP

- When your video equipment is connected, start playback.
- The following screen is displayed when only the picture signal projected now is input, or when no picture signal is input. You can choose the input source from this screen.

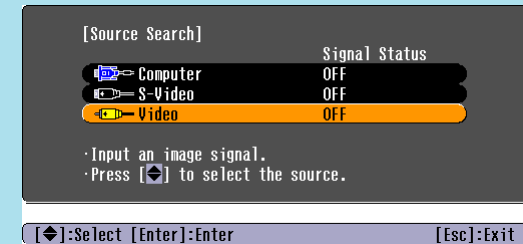

Changing Directly from the Remote Control

You can use the remote control to change directly to the target input source.

Remote Control

Changes to the image from the Computer port.

Changes to the image from the S-Video port.

Changes to the image from the Video port.

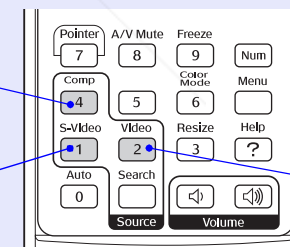



Useful Functions

This chapter explains useful functions for giving presentations and so on, and the security functions.

Functions for Enhancing Projection	20
• Pausing the Image and Sound (A/V Mute)	20
• Freezing the Image (Freeze)	20
• Changing the Aspect Ratio (Resizing)	21
• Displaying the Pointer (Pointer)	21
• Enlarging Part of the Image (E-Zoom)	22
• Using the Remote Control to Operate the Mouse Pointer (Wireless Mouse)	23

Security functions	26
• Preventing theft (Password Protect)	26
• When Password Protect is Enabled	26
• Setting Password Protect	27
• Operation Button Lock Function	29

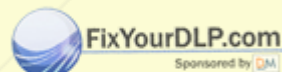

Discount-Merchant.com (800) 281-8860
THE TRUSTED SOURCE FOR PROJECTOR LAMPS AND ACCESSORIES

Pausing the Image and Sound (A/V Mute)

For example, this can be used if you want to pause the projection for a moment and focus the audience's attention on what you are saying. Or if you are making a computer presentation and you do not want to show details, such as selecting different files.

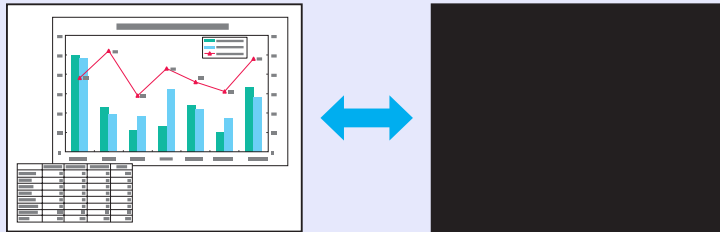

PROCEDURE

Remote control

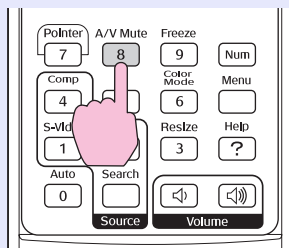

You can turn this function on or off by pressing the [A/V Mute] button.



- If you use this function when projecting moving images, the images and sound will still continue to be played back by the source, and you cannot return to the point where the A/V mute function was activated.
- The screen display in A/V mute can be chosen from black, blue, or a logo by using "Extended" "Display" "Background Color" in the configuration menu.

Freezing the Image (Freeze)

The source image continues to project even when the screen is frozen. You can still perform operations such as changing files, without projecting any images.

PROCEDURE

Remote control

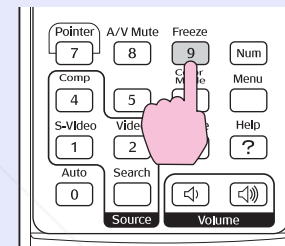

You can turn this function on or off by pressing the [Freeze] button.



- Sound does not stop.
- Even though the image on the screen is frozen, the image source continues to project, and so it is not possible to resume projection from the point where it was paused.
- Pressing the [Freeze] button also clears configuration menu displays and help messages.
- The freeze function still works while the E-Zoom function is being used.

Changing the Aspect Ratio (Resizing)

This function changes the [aspect ratio](#) of images from 4:3 to 16:9 when [component video](#), [S-Video](#), or [composite video](#) images are being projected.

Images which have been recorded in digital video or onto DVDs can be viewed in 16:9 wide-screen format.

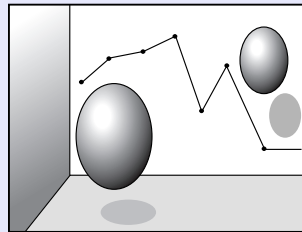

When images in [Squeeze mode](#) are projected at 4:3

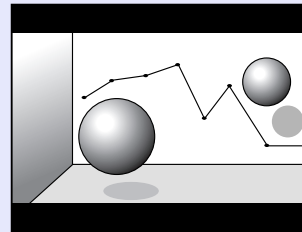

When images in squeeze mode are projected at 16:9

PROCEDURE

Remote control

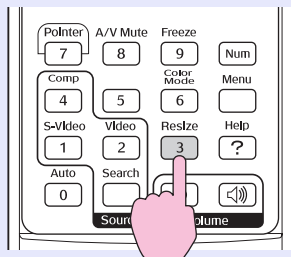

The display is changed whenever you press the button.

Displaying the Pointer (Pointer)

This allows you to move a pointer icon on the projected image, and helps you draw attention to the area you are talking about.

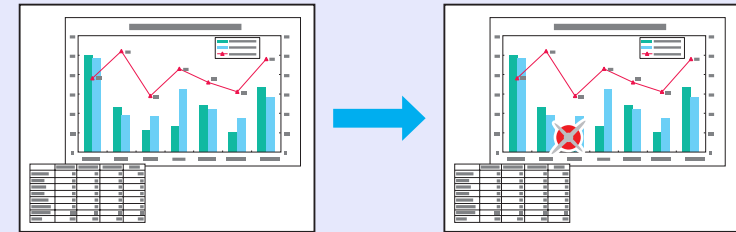

PROCEDURE



1 Display the pointer.

Remote control

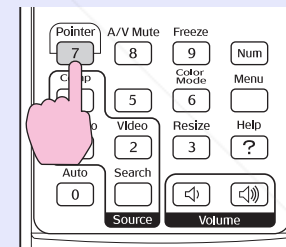

Each time you press the button the pointer appears or disappears.



TIP

You can also make this setting using the "Resize" command in the "Signal" menu.



2 Move the pointer icon.

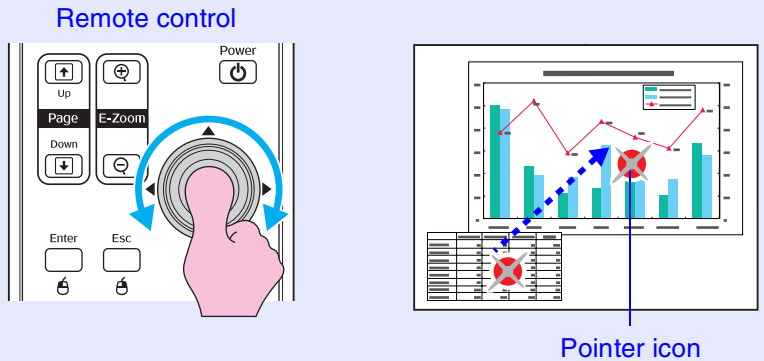

Enlarging Part of the Image (E-Zoom)

This is useful when you want to see images in greater detail, such as graphs and details in a table.

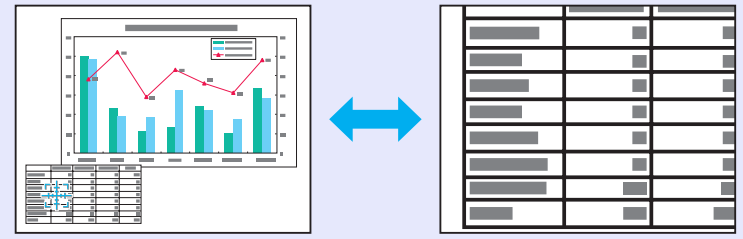

TIP You can use the "Pointer Shape" command in the "Settings" menu to change the shape of the pointer to one of three different shapes. [p.35](#)

PROCEDURE

1 Start E-Zoom.

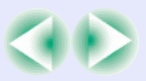
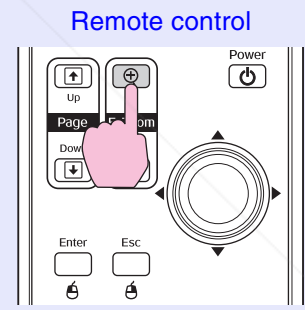

2 Move the cross to the area of the image that is to be enlarged or reduced.

Remote control

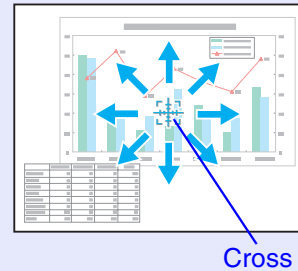
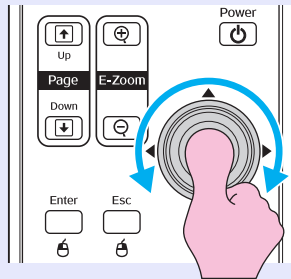

Using the Remote Control to Operate the Mouse Pointer (Wireless Mouse)

If the USB terminal of a computer and the USB terminal on the back of this projector are connected by a commercially available USB A-B cable, you can use the projector's remote control like a wireless mouse to control the computer's mouse pointer.

Computer

Windows 98/2000/Me/XP Home Edition/XP Professional
Macintosh (OS 8.6–9.2/10.0–10.3)

3 Enlarge.

Remote control

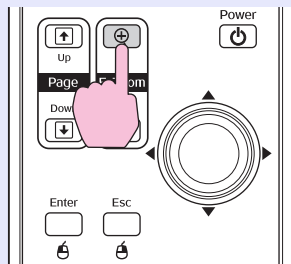

You can reduce the enlarged image by pressing the [-] button. To cancel the E-Zoom, press the [Esc] button.

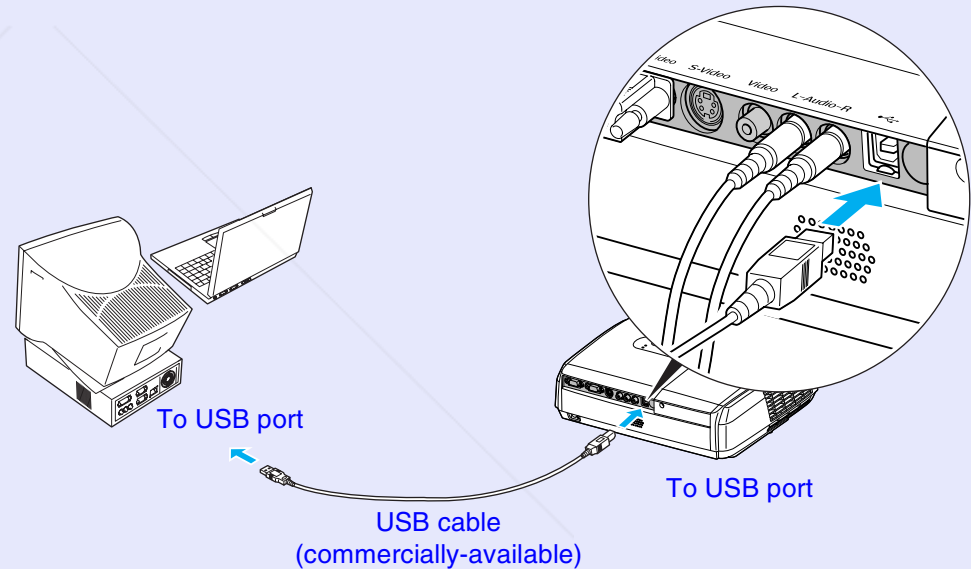

TIP

- The enlargement ratio will appear on the screen.
- You can scroll the screen by tilting the [E-Zoom] button.
- The selected area can be enlarged to between 1- 4 times, in 25 incremental steps.

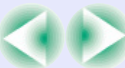



- *The USB cable can only be connected to computers with a standard USB interface. If using a computer which is running Windows, the computer must have had a full version of Windows 98/2000/Me/XP Home Edition/XP Professional installed. If the computer is running a version of Windows 98/2000/Me/XP Home Edition/XP Professional that has been upgraded from an earlier version of Windows, correct operation cannot be guaranteed.*
- *It may not be possible to use the mouse function under some versions of both the Windows and Macintosh operating systems.*
- *Some computer settings may have to be changed in order for the mouse function to be used. Consult the documentation for the computer for further details.*

Once the connection has been made, the mouse pointer can be operated as follows.

Moving the mouse pointer

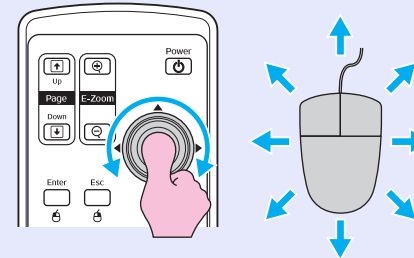

Mouse clicks

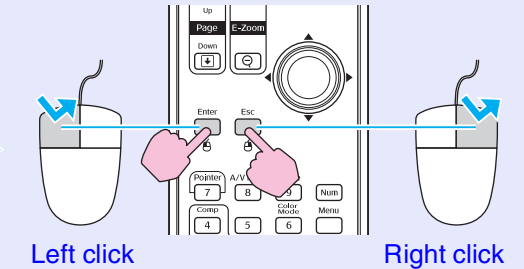

Left click

Right click

Double-click: Press twice in rapid succession.

Drag and drop

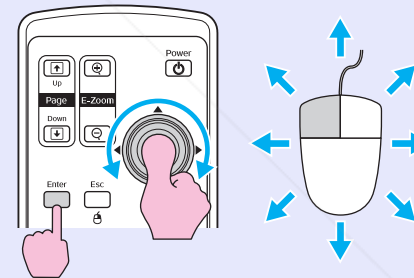

1. Hold down the [Enter] button and tilt and drag the [⊙] button.
2. Release the [Enter] button to drop at the desired location.

This is useful for displaying the previous or next slide in a PowerPoint slideshow.

To previous slide

To next slide

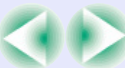
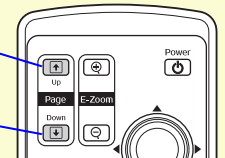



TIP

- *If the mouse button settings are set to reverse on the computer, the operation of the remote control buttons will also be reversed.*
- *The wireless mouse function cannot be used while the following functions are being used.*
 - *While a configuration menu is being displayed*
 - *While a help menu is being displayed*
 - *While the E-Zoom function is being used*
 - *While a user's logo is being captured*
 - *Pointer function*
 - *While adjusting sound volume*
 - *While Image Shift is being used*



FixYourDLP.com

Sponsored by 

Discount-Merchant.com (800) 281-8860

THE TRUSTED SOURCE FOR PROJECTOR LAMPS AND ACCESSORIES



Preventing theft (Password Protect)

When the Password Protect function is activated, people who do not know the password will not be able to use the projector to project images, if the power has been disconnected since the password was last entered correctly.

Furthermore, the user's logo that is displayed on the background of the screen cannot be changed. This is effective against theft. At the time of purchase, the password protection function is not enabled.

■ When Password Protect is Enabled

■ When "Power ON Protect" is enabled (ON)

When the power is turned on for the first time after the projector's power cable is connected to an electrical outlet, or when Direct Power On is carried out, the following password entry screen will be displayed.

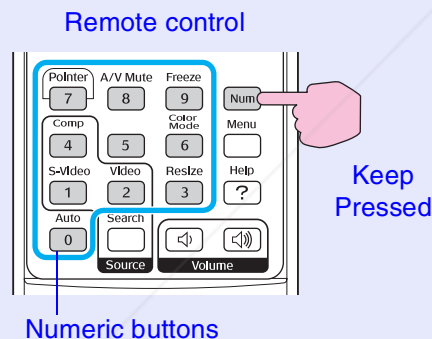
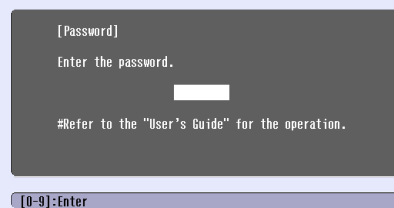

While holding down the [Num] button, press the numeric keypad buttons to enter the password. If the password is entered correctly, projection will start.

If you leave the power cable connected to the electrical outlet and turn the projector's power on when it is in standby mode, projection will start without the password entry screen appearing. The password entry screen will only be displayed when the power is turned on for the first time after the power cable has been disconnected and then reconnected. If Direct Power On is set to "ON" and you are using a circuit breaker or similar to centrally control the power, the password entry screen will be displayed the first time the projector is turned on after the power supply is restored.



TIP

• *If an incorrect password is entered three times in succession, the message "The projector's operation will be locked." will be displayed for approximately five minutes, and then the projector will switch to standby mode. If this happens, disconnect the power plug from the electrical outlet and then reinsert it and turn the projector's power back on. A window requesting you to enter the password will be displayed, so enter the correct password.*

If you happen to forget the password, make a note of the "Request Code: xxxxx" number that appears in the Password screen and contact the nearest address provided in the "International Warranty Conditions" section of the Safety Instructions/World-Wide Warranty Terms booklet.

• *If you continue to repeat the above operation and input the wrong password thirty times, the following message will be displayed and the projector will not accept password entries any more.*

"The projector's operation will be locked. Contact the nearest address provided in the "International Warranty Conditions" section of the Safety Instructions/World Wide Warranty Terms booklet."



■ When "Password Timer" is set to "ON" and "Timer" is used
The password entry screen will not be displayed at all when the power is turned on until the length of time that has been set has elapsed. When the set length of time has elapsed, the password entry screen will be displayed each time the power is turned on. The length of time referred to here is the total illumination time for the projector's lamp from the point when the projector's menu is closed.

If "Password Timer" is set to "OFF", the password entry screen will be displayed each time the power plug is disconnected and reinserted from the electrical outlet. If the projector's power is on when it is in standby mode, the password entry screen will not be displayed.

■ When "User's Logo Protect" is enabled (ON)

If an attempt is made to carry out any of the following user logo operations, a message is displayed and the setting cannot be changed. To change the setting, set "User's Logo Protect" to "OFF" first.  p.28

- Capturing a user's logo
- When the "Extended" - "Display" - "Background Color" menu is changed from "Logo" to "Black" or "Blue", or changed from "Black" or "Blue" to "Logo".
- When the "Extended" - "Display" - "Startup Screen" menu ("ON" or "OFF") is changed.

■ Setting Password Protect

Use the following procedure to set Password Protect.

PROCEDURE

-  **Hold down the [Freeze] button for approximately 5 seconds.**

The "Password Protect" menu will be displayed.

Remote control

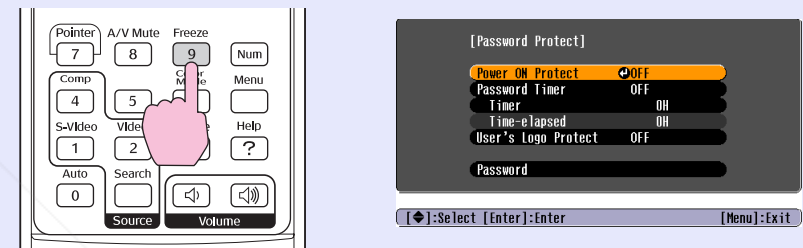

TIP

- *If Password Protect has already been enabled, the "Password" screen will be displayed.*
- *If the password has been entered correctly, the "Password Protect" menu will be displayed.*
- *"When Password Protect is enabled" p.26*
- *If Password Protect is set to "ON", attach the accessory Password Protect sticker to your preferred position on the projector as a theft-prevention measure.*

-  **Turn "Power ON Protect" on.**

- (1) Select "Power ON Protect", and then press the [Enter] button.
- (2) Select "ON", and then press the [Enter] button.
- (3) Press the [Esc] button.

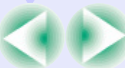

3 Turn "Password Timer" on.

If you don't use this setting, proceed to step 4.

- (1) Select "Password Timer", and then press the [Enter] button.
- (2) Select "ON", and then press the [Enter] button.
- (3) Press the [Esc] button.
- (4) Select "Timer" and then press the [Enter] button.
- (5) While holding down the [Num] button, use the numeric keypad buttons to enter the setting time within the range of 1 to 9999 hours and then press the [Enter] button.
If you make a mistake entering the time, press the [Esc] button and re-enter the time.
When you have finished using the "Password Protect" menu, the countdown for the elapsed time will start.

4 Turn "User's Logo Protect" on.

- (1) Select "User's Logo Protect", and then press the [Enter] button.
- (2) Select "ON", and then press the [Enter] button.
- (3) Press the [Esc] button.

5 Enter the password.

- (1) To set a password, select "Password" and then press the [Enter] button.
- (2) The message "Change the password?" will be displayed, so select "Yes" and then press the [Enter] button. The default setting for the password is "0000", but you should change this to your own desired password. If you select "No", the screen shown at step 1 will be displayed again.
- (3) While holding down the [Num] button, use the numeric keypad buttons to enter a 4-digit number. The number entered will be displayed as "* * * *". Once four digits have been entered, the confirmation screen will be displayed.
- (4) Re-enter the password.
The message "The new password is stored." will be displayed. If you enter the password incorrectly, a message will be displayed prompting you to re-enter the password.



Operation Button Lock Function

This function locks the buttons on the projector's control panel. This function is useful at times such as during show events so that only projection is carried out deactivating all buttons operation, or in places such as schools to limit the range of buttons that can be operated.

PROCEDURE

- 1 From the configuration menu, select "Settings" - "Operation Lock".

For details on this operation, refer to "Using the Configuration Menu". [p.32](#)

Check the buttons you can use and the operations they perform in the guide at the bottom of the screen.

Using the remote control

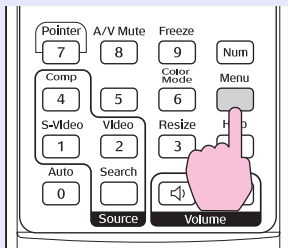

Using the control panel

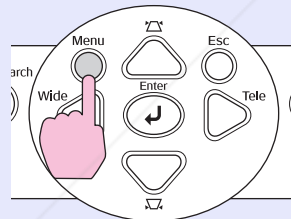

- 2 Set to "ON".

If set to "ON", none of the buttons on the control panel except the [Power] button can be operated.

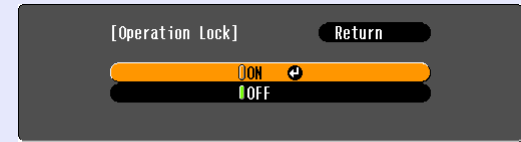

Using the remote control

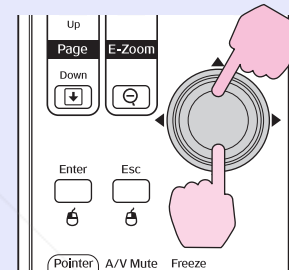

Using the control panel

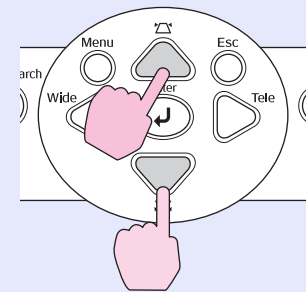

3 When the confirmation message is displayed, select "Yes".

The control panel buttons will be locked in accordance with the selected setting.



TIP

There are two methods to cancel the projector's control panel lock.

- *Using remote control, change the "Settings" - "Operation Lock" in the configuration menu to "OFF" .*
- *Hold down the projector's [Enter] button continuously for about 7 seconds, a message will be displayed and the lock will be cancelled.*



FixYourDLP.com

Sponsored by **Discount-Merchant.com (800) 281-8860****THE TRUSTED SOURCE FOR PROJECTOR LAMPS AND ACCESSORIES**

Configuration Menu

This chapter explains how to use the configuration menu and its functions.

Using the Configuration Menu.....	32
List of Functions	33
• "Image" Menu.....	33
• "Signal" Menu.....	34
• "Settings" Menu.....	35
• "Extended" Menu	36
• "Info" Menu	38
• "Reset" Menu	39

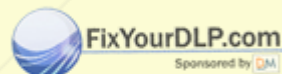

Discount-Merchant.com (800) 281-8860
THE TRUSTED SOURCE FOR PROJECTOR LAMPS AND ACCESSORIES

1 Selecting from the top menu

Top menu

guide

[Left Arrow]:Select [Enter]:Enter [Menu]:Exit

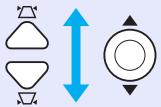

[Left Arrow]:Select [Enter]:Enter [Menu]:Exit

2 Selecting from the sub menu

Sub menu (Settings)

Enter Enter

Esc Esc

[Esc]:Return [Left Arrow]:Select [Enter]:Enter [Menu]:Exit

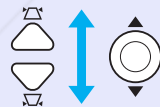

Enter Enter

Esc Esc

[Esc]:Return [Left Arrow]:Select [Enter]:Enter [Menu]:Exit

3 Changing the selected item

[Esc]:Return [Left Arrow]:Select [Right Arrow]:Adjust [Menu]:Exit

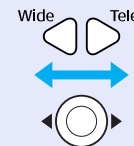

[Esc]:Return [Left Arrow]:Select [Enter]:Set [Menu]:Exit

[Esc]:Return [Left Arrow]:Select [Enter]:Set [Menu]:Exit

Buttons used

Using the control panel

Using the remote control

Select the setting to change.

[Esc]:Return [Left Arrow]:Select [Enter]:Set [Menu]:Exit

Discount-Merchant.com (800) 281-8860
THE TRUSTED SOURCE FOR PROJECTOR LAMPS AND ACCESSORIES

"Image" Menu

The items that can be set will vary depending on the input source that is currently being projected. Setting details are saved separately for each source.

Computer/RGB video

[Component video](#) / [Composite video](#) / [S-Video](#)

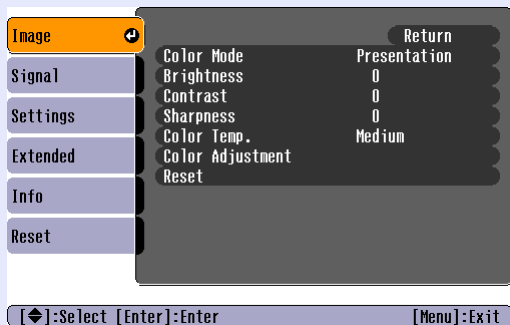

Sub-menu	Function
Color Mode	Select the quality of the image to suit your surroundings. p.14
Brightness	Adjusts the image brightness.
Contrast	Adjusts the difference between light and shade in the images.
Color Intensity	Adjusts the colour intensity for the images.
Tint	(Adjustment is only possible when component video or NTSC signals are being input.) Adjust the image tint.
Sharpness	Adjusts the image sharpness.
Color Temp.	You can adjust the overall tint of images. If you select "High", images appear bluish, and if you select "Low", images appear reddish. (This item cannot be selected if " sRGB " has been selected as the "Color Mode" setting in the "Image" menu.)
Color Adjustment	Adjusts the red, green, and blue colour strength of the image. Red: Adjust the intensity of the red component. Green: Adjusts the intensity of the green component. Blue: Adjusts the intensity of the blue component. (This item cannot be selected if " sRGB " has been selected as the "Color Mode" setting in the "Image" menu.)
Reset	Resets all adjustment values for the "Image" menu functions to their default settings. If you would like to return all menu items to their default, see "Reset All" p.39

"Signal" Menu

The items that can be set will vary depending on the input source that is currently being projected. Setting details are saved separately for each source.

Computer/RGB video

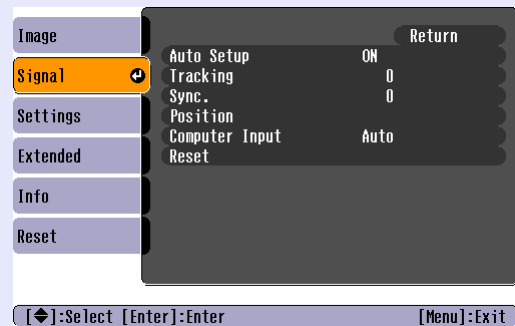

Component video»

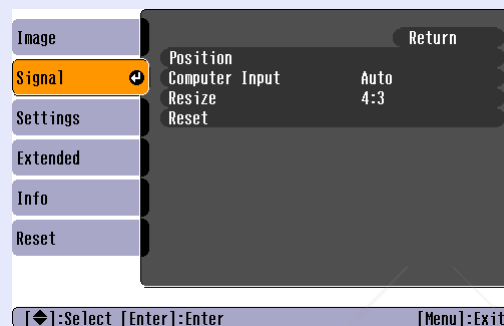



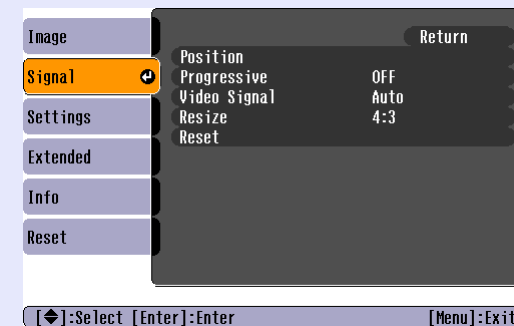





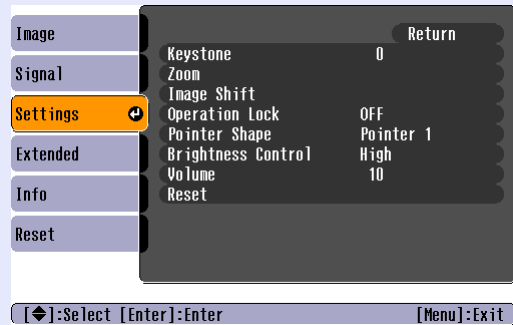



Composite video»/ S-Video»



Sub-menu	Function
Auto Setup	Selects whether the automatic adjustment function for automatically optimising images when the input source is changed is turned "ON" or "OFF". p.12
Tracking»	Adjusts computer images when vertical stripes appear in the images. p.12
Sync.»	Adjusts computer images when flickering, fuzziness or interference appear in the images. p.13
Position	Moves the image display position vertically and horizontally.
Progressive	(Adjustment is only possible when composite Video/S-Video/Component video signals are being input.) OFF: IP conversion is carried out for each field in the screen. This is ideal for using when viewing images with a large amount of movement. ON: Interlaced» (i) signals are converted into progressive» (p) signals. This is ideal for using when viewing still images.
Computer Input	Selects the input signal in accordance with the equipment that is connected to the Computer port. If set to "Auto" the input signal is set automatically in accordance with the connected equipment. If the colours do not appear correctly when you select "Auto", select the appropriate signal for the connected equipment manually.
Video Signal	(Adjustment is only possible when composite video/S-Video signals are being input.) Sets the video signal. With the "Auto" function, image signals are recognized automatically. If interference appears in the projected images or no images appear when you select "Auto", select the appropriate signal manually.
Resize	Sets the aspect ratio» for projected images. p.21
Reset	All the adjustment values on the "Signal" menu, except "Computer Input", are returned to their default values. Press the [Enter] button on the remote control or on the projector's control panel. If you would like to return all menu items to their default, see "Reset All". p.39

"Settings" Menu



Sub-menu	Function
Keystone	Corrects vertical keystone distortion in images.  Setup Guide
Zoom	Adjusts the size of the projected image.  Setup Guide Wide: Larger Tele: Smaller
Image Shift	Adjusts the projection position.  p.16
Operation Lock	When set to "ON", the operation of all buttons on the projector's control panel except for the [Power] button will be disabled.  p.29
Pointer Shape	The shape of the pointer can be selected.  p.21 Pointer 1:  Pointer 2:  Pointer 3: 
Brightness Control	This lets you set the lamp brightness to one of two settings. Select "Low" if the images being projected are too bright such as when projecting images in a dark room or onto a small screen. When "Low" is selected, the brightness of the images is reduced, the amount of electricity consumed and noise produced during projection are reduced and the lamp's operating life is extended. (Electrical consumption: about an 18 W decrease, lamp life: about 1.5 times longer)
Volume	Adjusts the volume.  p.17
Reset	Adjustment values for the "Settings" menu functions are returned to their default settings, except for "Image Shift" and "Zoom". If you would like to  turn all menu items to their default, see "Reset All".  p.39

Sponsored by  FixYourDLP.com

Discount-Merchant.com (800) 281-8860

THE TRUSTED SOURCE FOR PROJECTOR LAMPS AND ACCESSORIES

"Extended" Menu



Sub-menu	Function
Display	<p>This lets you make settings related to the projector's display.</p> <p>Message: Sets whether the input source name or colour mode name or a message is displayed on the screen ("ON") or not displayed ("OFF") at times such as when the input source or colour mode is changed or when no image signals are being input.</p> <p>Background Color: Sets the screen status when the [A/V Mute] button on the remote control is being pressed or when no image signals are being input to "Black", "Blue" or "Logo".</p> <p>Startup Screen: The startup screen (the image projected when starting the projector) is displayed when starting (ON)/ or not displayed when starting (OFF). The setting is enabled after turning the power supply off and then back on.</p>
User's Logo	Change the user's logo that is displayed as a background and displayed during A/V Mute. p.63
Projection	<p>Sets the projection position for the projector. p.55</p> <p>"Front" "Front / Ceiling" "Rear" "Rear / Ceiling"</p> <p>By holding down the [A/V Mute] button for about 5 seconds, you can change the projection setup in the following ways.</p> <p>Front ↔ Front Ceiling Rear ↔ Rear Ceiling</p>

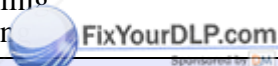

Sub-menu	Function
Operation	<p>Direct Power ON: Sets whether direct power on is enabled ("ON") or disabled ("OFF"). When you set to "ON" and leave the power cable connected to a wall socket, be aware of that sudden surges of electricity that may occur when power comes back on after a power outage may cause the projector to turn on automatically.</p> <p>Sleep Mode: Sets whether projection stops automatically ("ON") or not ("OFF") when no operations are carried out for approximately 30 minutes while no image signals are being input.</p> <p>Fan Speed: When using above an altitude of about 1500m, set to "High".</p>
Link 21L	<p>Sets whether the EMP Link 21L utility software is being used or not. To enable the EMP Link 21L, turn the projector's power off and wait until the cool down period has finished.</p>
Language	<p>Sets the language for message displays.</p>
Reset	<p>Returns "Display" and "Operation" settings in the "Extended" menu (except for "Fan Speed") to their default settings. If you would like to return all menu items to their default, see "Reset All".  p.39</p>



"Info" Menu

Lets you check the status of the image signals being projected and the status of the projector. (Display only)

Computer/RGB Video/[Component video](#)

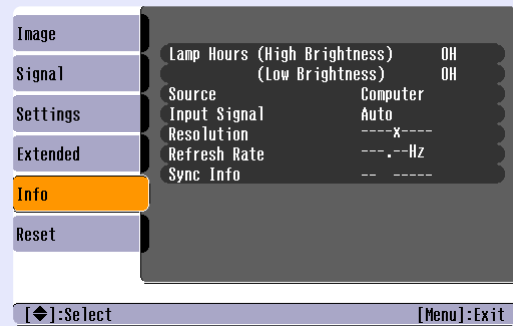

[Composite video](#)/[S-Video](#)

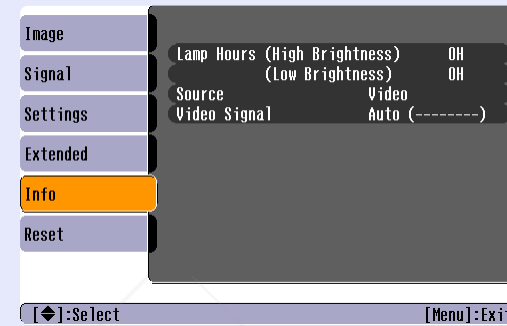

Sub-menu	Function
Lamp Hours	Shows the cumulative lamp operating time. If it reaches the lamp warning time, the characters are displayed in yellow. The cumulative operating time from 0 to 10 hours will be displayed as "0H". From "10H" onwards, the display will be in units of 1 hour.
Source	Displays the input source which is currently being projected.
Input Signal	Displays the input signal settings. (Does not appear when the input source is composite video or S-video.)
Resolution	Displays the input resolution. (Does not appear when the input source is composite video or S-video.)
Video Signal	Shows the video signal format. (Not displayed for computer, RGB video, or component video images.)
Refresh Rate	Displays the refresh rate. (Does not appear when the input source is composite video or S-video.)
Sync Info	Information from this menu may be required when you ask for service from your dealer or from the nearest address provided in the "International Warranty Conditions" section of the <i>Safety Instructions/World Wide Warranty Terms</i> booklet. (Does not appear when the input source is composite video or S-video.)

"Reset" Menu

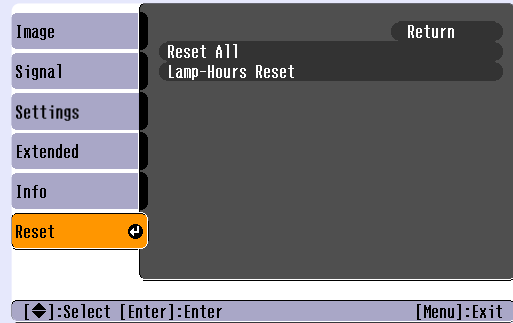

Sub-menu	Function
Reset All	Resets all items in all menus to their default settings. <ul style="list-style-type: none"> •The "Computer Input", "Zoom", "Image Shift", "User's Logo", "Lamp Hours" and "Language" settings will not be reset to their defaults.
Lamp-Hours Reset	Clear the cumulative lamp operating time and reset to "0H". Perform this procedure when you replace the lamp.



Troubleshooting

This chapter describes how to identify problems and what to do if a problem is found.

Using the Help.....	41
Problems Solving.....	43
• Reading the Indicators.....	43
• Power indicator lights red	43
• Lamp or Temp indicator flashes orange	44
• When the Indicators Provide No Help	46
• Problems relating to images	47
• Problems when projection starts.....	52
• Other problems	52

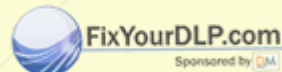

Discount-Merchant.com (800) 281-8860
THE TRUSTED SOURCE FOR PROJECTOR LAMPS AND ACCESSORIES

If a problem occurs with the projector, the Help function uses on-screen displays to assist you in solving the problem. It uses a series of menus in a question and answer format.

PROCEDURE

1 Display the Help menu.

Using the remote control

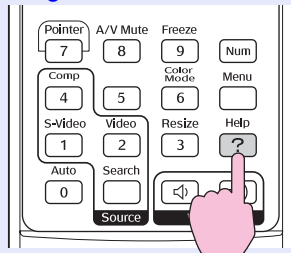

Using the control panel

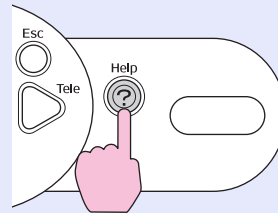

2 Select a menu item.

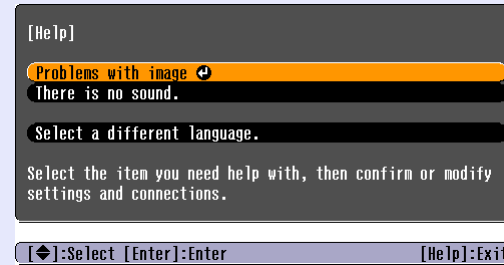

Using the remote control

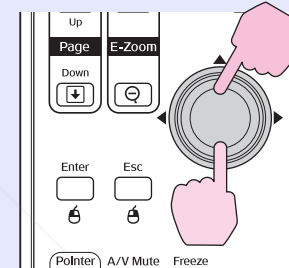

Using the control panel

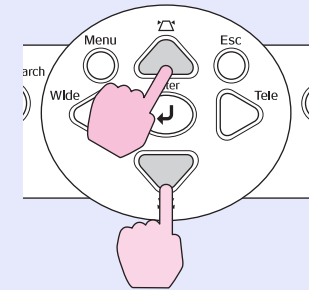

3 Confirm the selection.

Using the remote control

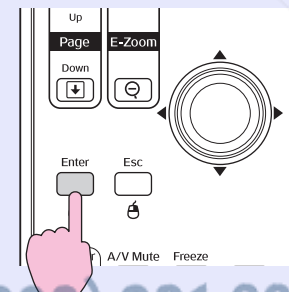

Using the control panel

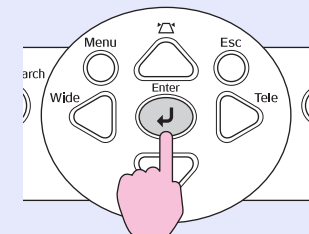

- 4 Repeat the operations in steps 2 and 3 to proceed through the menu to more detailed items.

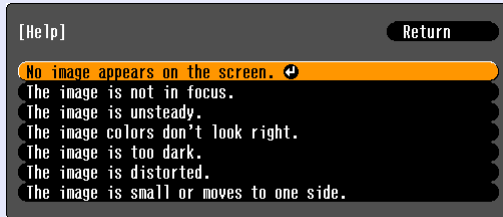

[Esc]:Return [↓]:Select [Enter]:Enter [He lp]:Exit

- 5 Press the [Help] button to exit the help menu.



TIP

If the Help function does not provide a solution to the problem, refer to "Problem Solving" [p.43](#)



FixYourDLP.com

Sponsored by **Discount-Merchant.com (800) 281-8860****THE TRUSTED SOURCE FOR PROJECTOR LAMPS AND ACCESSORIES**

If you are having a problem with the projector, first check the projector's indicators and refer to "Reading the Indicators" below. If the indicators do not show clearly what the problem might be, refer to "When the Indicators Provide No Help". [p.46](#)

Reading the Indicators

The projector is provided with the following three indicators which indicate the operating status of the projector.

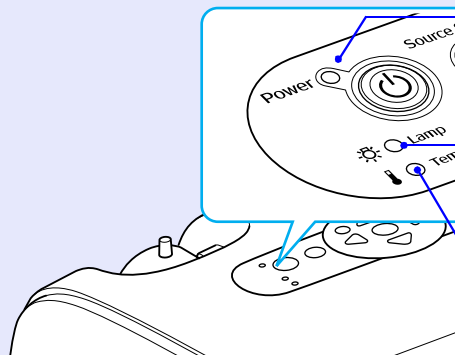

- Indicates the operating status of the projector.
 - Orange: Standby condition
Projection starts again when the [Power] button is pressed.
You can disconnect the power plug from the electrical outlet when the status light is in this condition.
 - Green : Warm-up in progress
Warm-up time is approximately 30 seconds. After warm-up is complete, the indicator will stop flashing.
 - Green : Projection in progress
- Indicates the projection lamp status.
- Indicates the internal temperature status.

The following tables show what the indicators mean and how to remedy problems that they indicate. If all indicators are switched off, check that the power cable is connected correctly and that power is being supplied normally.

Power indicator lights red **Abnormal**

● : lit ● (with radiating lines) : flashing ○ : off

Status	Cause	Remedy or Status
Power ● Red ● (with radiating lines) Red ● (with radiating lines) Red	Internal error	Stop using the projector, disconnect the power cable from the electrical outlet, and contact your dealer or the nearest address provided in the "International Warranty Conditions" section of the <i>Safety Instructions/World-Wide Warranty Terms</i> booklet.
Power ● Red ● (with radiating lines) Red ● (with radiating lines) Red	Fan related error/ Sensor error	Stop using the projector, disconnect the power cable from the electrical outlet, and contact your dealer or the nearest address provided in the "International Warranty Conditions" section of the <i>Safety Instructions/World-Wide Warranty Terms</i> booklet.

THE TRUSTED SOURCE FOR PROJECTOR LAMPS AND ACCESSORIES



● : lit ☀ : flashing ○ : off

Status	Cause	Remedy or Status
Power ● Red ☀ ○ 🌡 ● Red	Internal temperature error (overheating)	The lamp will turn off automatically and projection will stop. Wait for about 5 minutes. After about 5 minutes the projector will switch to standby mode, so check the following two points. After checking, press the [Power] button to turn the power back on. •Check that the air filter and air exhaust vent are clear, and that the projector is not positioned against a wall. •If the air filters are blocked, clean or replace them. p.56, p.62 If this does not solve the problem and the projector continues to overheat or the indicators continue to show a problem when the power is turned on, stop using the projector, disconnect the power cable from the wall outlet, and contact your dealer or the nearest address provided in the "International Warranty Conditions" section of the <i>Safety Instructions/World-Wide Warranty Terms</i> booklet.
Power ● Red ☀ ● Red 🌡 ○	Lamp timer failure/ Lamp out	Take out the lamp and check if it is broken. p.58 If the lamp is not broken, put it back in and then turn the power on. If the lamp still does not turn on, replace it with a new lamp. If this does not solve the problem, stop using the projector and disconnect the power cable from the electrical outlet. Then contact your dealer or the nearest address provided in the "International Warranty Conditions" section of the <i>Safety Instructions/World-Wide Warranty Terms</i> booklet If the lamp is broken replace it with a new lamp, or contact your local dealer for further advice. If replacing the lamp yourself, be careful to avoid pieces of broken glass. (Projection cannot be carried out until the lamp is replaced.) Check that the lamp and the lamp cover are securely installed. If the lamp or lamp cover is not securely installed, the lamp will not switch on.

■ Lamp or Temp indicator flashes orange **Warning**

● : lit ☀ : flashing ○ : off

Status	Cause	Remedy or Status
Power ● Red ☀ ○ 🌡 ☀ Orange	High-speed cooling in progress	(This is not an abnormality, but if the temperature rises too high again, projection will stop automatically.) •Check that the air filters and air exhaust vent are clear and that they are not up against a surface such as a wall. •If the air filters are clogged, clean or replace them. p.56, p.62

Discount-Merchand.com (800) 281-8860

 THE TRUSTED SOURCE FOR PROJECTOR LAMPS AND ACCESSORIES

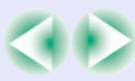

● : lit ☀ : flashing ○ : off

Status	Cause	Remedy or Status
Power ● ☀ Orange 🔧 ○	Lamp replacement notification	Replace the lamp with a new one. p.58 If you continue to use the lamp after it has passed the replacement period, the possibility that the lamp may break will increase. Replace the lamp with a new one as soon as possible. The Power indicator status will vary depending on the projector status at the time.



TIP

- *If the projector is not operating properly even though the indicators are all showing normal, refer to "When the Indicators Provide No Help" on the following page.*
- *If an indicator is showing a status which does not appear in the previous tables, contact your dealer or the nearest address provided in the "International Warranty Conditions" section of the Safety Instructions/World-Wide Warranty Terms booklet.*

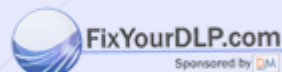











Discount-Merchant.com (800) 281-8860
 THE TRUSTED SOURCE FOR PROJECTOR LAMPS AND ACCESSORIES



When the Indicators Provide No Help

If any of the following problems occur and the indicators do not offer a solution, refer to the pages given for each problem.



Problems relating to images

- No images appear  [p.47](#)
Projection does not start, the projection area is completely black, the projection area is completely blue, etc.
- Projection stops automatically  [p.47](#)
- The message "Not Supported." is displayed  [p.48](#)
- The message "No Signal." is displayed  [p.48](#)
- Images are fuzzy or out of focus  [p.49](#)
- Interference or distortion appear in images  [p.49](#)
Problems such as interference, distortion or black & white checked patterns appear.
- Image is truncated (large) or small  [p.50](#)
Only part of the image is displayed.
- Image colours are not right  [p.51](#)
The whole image appears purplish or greenish, images are black & white, colours appear dull, etc.
(Computer monitors and LCD screens have different colour reproduction performance, so that the colours projected by the projector and the colours appearing on the monitor may not necessarily match, but this is not a sign of a problem.)
- Images appear dark  [p.51](#)
- Nothing appears on the external monitor  [p.51](#)

Problems when projection starts

- Power does not turn on  [p.52](#)



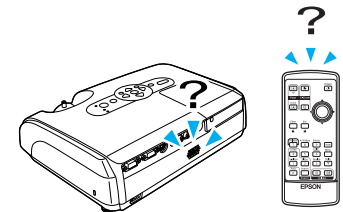

Other problems

- No sound can be heard or the sound is faint  [p.52](#)
- The remote control does not work  [p.53](#)



■ Problems relating to images



■ No images appear

Check	Remedy
Was the [Power] button pressed?	Press the [Power] button to turn the power on.
Are the indicators switched off?	The power cable is not connected correctly or power is not being supplied normally. Connect the projector's power cable correctly.  Setup Guide Check that your power supply socket is working.
Is A/V Mute mode active?	Press the [A/V Mute] button on the remote control to cancel the mute.  p.20
Have the configuration menu settings been made correctly?	Reset all of the settings. "Reset" - "Reset All"  p.39
Is the projected image completely black? Only when projecting computer images	Some input images, such as screen savers, may be completely black.
Are the image signal format settings correct? Only when projecting images from a video source	If a composite video or S-Video source is connected to the projector, use the "Video Signal" menu command to select the signal format. "Signal" - "Video Signal"  p.34





■ Projection stops automatically

Check	Remedy
Is "Sleep Mode" set to "ON"?	When the "Sleep Mode" menu command has been set to "ON", the lamp turns off automatically if no operations are carried out for about 30 minutes while no video signal is being input. The Power indicator is lit orange at this time. Press the [Power] button to turn the power on. If you do not want sleep mode to be used, change the "Sleep Mode" setting to "OFF". "Extended" - "Operation" - "Sleep Mode"  p.37

■ The message "Not Supported." is displayed



Check	Remedy
<p>Are the image signal format settings correct?</p> <p>Only when projecting images from a video source</p>	<p>If a composite video or S-Video source is connected to the projector, use the "Video Signal" menu command to select the signal format. "Signal" - "Video Signal"  p.34</p>
<p>Does the mode match the frequency and resolution of the image signals?</p> <p>Only when projecting computer images</p>	<p>Refer to the documentation provided with your computer for details on changing the resolution and frequency of the image signals being output from the computer. "List of Supported Monitor Displays"  p.71</p>

■ The message "No Signal." is displayed





Check	Remedy
<p>Are the cables connected correctly?</p>	<p>Check that all of the cables required for projection are securely connected.  Setup Guide</p>
<p>Has the correct video input port been selected?</p>	<p>Press the [Computer], [S-Video] or [Video] button on the remote control or the [Source Search] button on the remote control or the projector's control panel to change the image.  p.18</p>
<p>Is the power for the computer or video source turned on?</p>	<p>Turn the power on for the devices.</p>
<p>Are the image signals being output to the projector?</p> <p>Only when projecting images from a laptop computer or computer with a built-in LCD screen</p>	<p>If the image signals are only being output to the computer's LCD monitor or to the accessory monitor, you need to change the output to an external destination as well as the computer's own monitor. For some computer models, when the image signals are output externally, they no longer appear on the LCD monitor or accessory monitor.</p> <p> Computer documentation, under a title such as "External output" or "Connecting an external monitor"</p> <p>If the connection is made while the power is already turned on, the function [Fn] key that switches the computer's video signal to external output may not work. Turn the power for the projector and the computer off and then back on again.  Setup Guide</p>



■ Images are fuzzy or out of focus

Check	Remedy
Has the focus been adjusted correctly?	Turn the focus ring on the projector to adjust the focus.
Is the lens cover still attached?	Remove the lens cover.
Is the projector at the correct distance?	The recommended projection distance ranges from 87cm to 1212cm.  Setup Guide
Is the keystone adjustment value too large?	Decrease the projection angle to reduce the amount of keystone correction.  Setup Guide
Is the zoom adjustment value too small?	Enlarge the zoom adjustment value.  Setup Guide
Has condensation formed on the lens?	If the projector is suddenly taken from a cold environment to a warm environment or if sudden ambient temperature changes occur, condensation may form on the surface of the lens, and this may cause the images to appear fuzzy. Set the projector up in the room approximately one hour before it is to be used. If condensation forms on the lens, turn the power off and wait for the condensation to disappear.







■ Interference or distortion appear in images

Check	Remedy
Are the image signal format settings correct? <div style="background-color: black; color: white; padding: 5px; display: inline-block;">Only when projecting images from a video source</div>	If a composite video or S-Video source is connected to the projector, use the "Video Signal" menu command to select the signal format. "Signal" - "Video Signal"  p.34
Are the cables connected correctly?	Check that all of the cables required for projection are securely connected.  Setup Guide
Is an extension cable being used?	If an extension cable is used, electrical interference may affect the signals. Use the accessory cables and check if this helps.
Has the correct resolution been selected? <div style="background-color: black; color: white; padding: 5px; display: inline-block;">Only when projecting computer images</div>	Set the computer so that the signals that are output are compatible with this projector. "List of Supported Monitor Displays"  p.71  Computer documentation
Have the " Sync " and " Tracking " settings been adjusted correctly? <div style="background-color: black; color: white; padding: 5px; display: inline-block;">Computer and RGB video signals only</div>	Press the [Auto] button on the remote control or the [Enter] button on the projector's control panel to carry out automatic adjustment. If the images have not been adjusted correctly after using automatic adjustment, you can make the adjustments using the "Sync" and "Tracking" functions.  p.12 , p.13





■ Image is truncated (large) or small

Check	Remedy
<p>Has the "Aspect ratio" been set correctly?</p>	<p>Press the [Resize] button on the remote control. p.21</p>
<p>Is the image still being enlarged by the E-Zoom function?</p>	<p>Press the [Esc] button on the remote control to cancel the E-Zoom function. p.22</p>
<p>Has the "Position" setting been adjusted correctly?</p>	<p>If analogue RGB images from a computer or RGB video images are being projected, press the [Auto] button on the remote control or the [Enter] button on the projector's control panel to carry out automatic adjustment. If the images have not been correctly adjusted after using the automatic setup function, adjust the setting manually using the "Position" menu command. If signals other than analogue RGB images from a computer or RGB video images are being input, adjust the setting manually using the "Position" menu command. "Signal" - "Position" p.34</p>
<p>Has the computer been set for dual display? Only when projecting computer images</p>	<p>If dual display has been activated in the Display Properties of the computer's Control Panel, the projector will only project about half of the image on the computer screen. To display the whole of the image on the computer screen, turn off the dual display setting. Computer video driver documentation</p>
<p>Has the correct resolution been selected? Only when projecting computer images</p>	<p>Set the computer so that the signals that are output are compatible with this projector. "List of Supported Monitor Displays" p.71 Computer documentation</p>

■ Image colours are not right

Check	Remedy
Do the input signal settings match the signals from the connected device?	If a composite video or S-Video source is connected to the projector, use the "Video Signal" menu command to select the video signal format. "Signal" - "Video Signal"  p.34
Has the image brightness been adjusted correctly?	Use the "Brightness" menu command to adjust the brightness. "Image" - "Brightness"  p.33
Are the cables connected correctly?	Check that all of the cables required for projection are securely connected.  Setup Guide
Has the image contrast been adjusted correctly?	Use the "Contrast" menu command to adjust the contrast. "Image" - "Contrast"  p.33
Has the colour been adjusted correctly?	Use the "Color Adjustment" menu command to adjust the colour. "Image" - "Color Adjustment"  p.33
Have the colour intensity and tint been adjusted correctly?	Use the "Color Intensity" and "Tint" menu commands to adjust the colour and tint. "Image" - "Color Intensity", "Tint"  p.33
Only when projecting images from a video source	

■ Images appear dark

Check	Remedy
Have the image brightness and luminance been adjusted correctly?	Use the "Brightness" and "Brightness Control" menu commands to adjust the brightness and luminance. "Image" - "Brightness"  p.33 "Settings" - "Brightness Control"  p.35
Has the image contrast been adjusted correctly?	Use the "Contrast" menu command to adjust the contrast. "Image" - "Contrast"  p.33
Is the lamp due for replacement?	When the lamp is nearly due for replacement, the images will become darker and the colour quality will become poorer. When this happens, the lamp should be replaced with a new one.  p.58

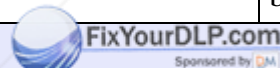

■ Nothing appears on the external monitor

Check	Remedy
Are images from a port other than the Computer port being projected?	The only images that can be displayed on an external monitor are those from the Computer port. You cannot output video equipment images to an external monitor.  p.65



■ Problems when projection starts

■ Power does not turn on



Check	Remedy
Have you pressed the [Power] button?	Press the [Power] button to turn the power on.
Are all of the indicators switched off?	The power cable is not connected correctly or power is not being supplied. Connect the power cable to the projector correctly.  Setup Guide Alternatively, check the circuit breaker to see if power is being supplied.
Do the indicators turn off and on when the power cable is touched?	There is probably a poor contact in the power cable, or the power cable may be defective. Reinsert the power cable. If this does not solve the problem, stop using the projector, disconnect the power cable from the wall outlet and contact the nearest address provided in the "International Warranty Conditions" section of the <i>Safety Instructions/World-Wide Warranty Terms</i> booklet.

■ Other problems

■ No sound can be heard or the sound is faint

Check	Remedy
Is the audio source connected correctly?	Check that the cable is connected to the Audio port.
Has the volume been adjusted to the minimum setting?	Adjust the volume so that sound can be heard.  p.17
Is A/V Mute mode active?	Press the [A/V Mute] button on the remote control to cancel the A/V mute function.  p.20

■ The remote control does not work

Check	Remedy
Is the remote control light-emitting area facing towards the remote control light-receiving area when it is operated?	Face the remote control towards the remote control light-receiving area. The operating angle for the remote control is approximately $\pm 30^\circ$ horizontally and approximately $\pm 15^\circ$ vertically.  Setup Guide
Is the remote control too far from the projector?	The operating range for the remote control is approximately 6m.  Setup Guide
Is direct sunlight or strong light from fluorescent lamps shining onto the remote control light-receiving area?	Set the projector up in a location where strong light will not shine onto the remote control light-receiving area.
Are the batteries dead, or have the batteries been inserted correctly?	Insert new batteries, while making sure that they are inserted the correct way around.  p.57
Has a remote control button been pressed for more than 30 seconds?	If any of the buttons on the remote control are pressed down for more than 30 seconds, the remote control stops sending signals (remote control's sleep mode) . The purpose of this is to prevent the batteries from being consumed due to something being placed on top of the remote control. When the button is released, normal remote control operation will resume.

Appendices

This chapter provides information on maintenance procedures to ensure the best level of performance from the projector.

Installation	55	Optional Accessories and Consumables	66
• Setting Up the Projector	55	• Optional Accessories	66
Maintenance	56	• Consumables	66
• Cleaning	56	Glossary	67
• Cleaning the Projector's Surface	56	List of ESC/VP21 Commands	69
• Cleaning the Lens	56	• Command List	69
• Cleaning the Air Filters and Air Intake Vent	56	• Cable Layouts	69
• Replacing Consumables	57	• USB connection	69
• Replacing the batteries	57	• USB Connection Setup	70
• Lamp Replacement Period	58	List of Supported Monitor Displays	71
• Replacing the Lamp	58	• Computer/RGB Video	71
• Resetting the Lamp Operating Time	61	• Component Video/RGB Video	71
• Replacing the Air Filter	62	• Composite Video/S-Video	71
Saving a User's Logo	63	Specifications	72
Checking Projected Images on an External Monitor (Monitor Output)	65	Appearance	73
		Index	74



Setting Up the Projector

The projector supports the following four different projection methods, allowing you to choose the best method for displaying your images.

CAUTION

- *Before setting up the projector, make sure you read the separate Safety Instructions/World-Wide Warranty Terms first.*
- *Do not set this projector up on its side to carry out projection, otherwise malfunctions may occur.*

- Front projection (Front projection)

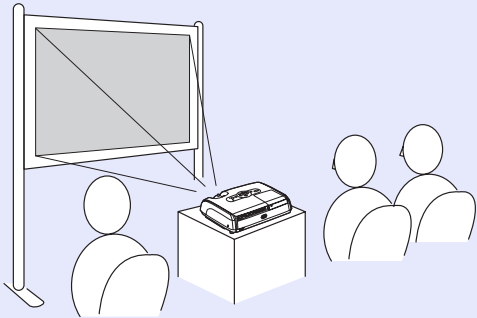

- Rear projection using a translucent screen (Rear projection)

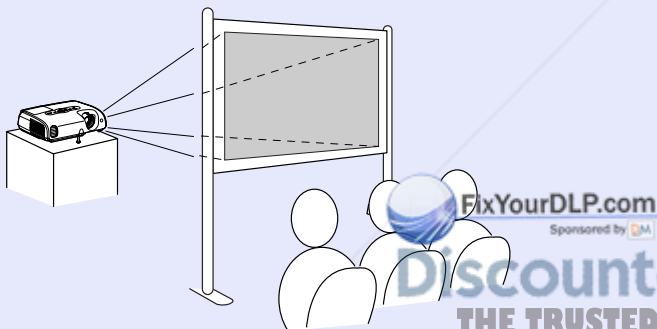

- Front/ceiling projection (Front/Ceiling projection)

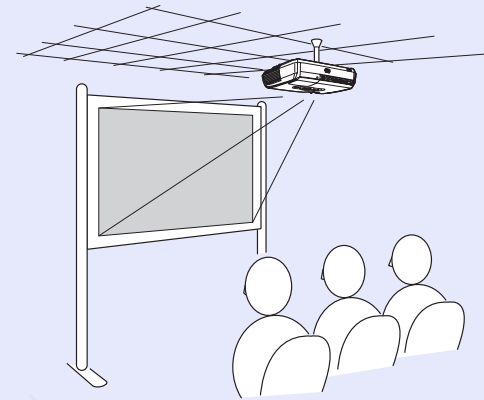

- Rear/ceiling projection using a translucent screen (Rear/Ceiling projection)

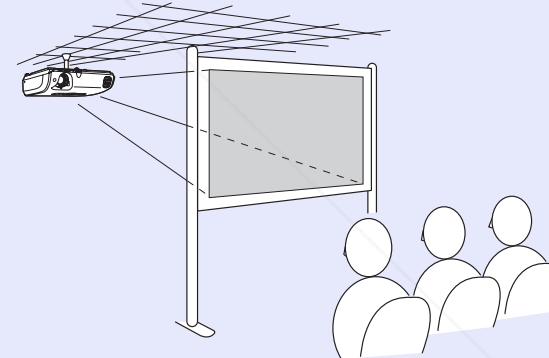

- * A special method of installation is required for suspending the projector from a ceiling. Please contact your supplier if you would like to use this installation method. The optional ceiling mount is required when installing the projector on a ceiling. [p.66](#)



When using ceiling projection or projection using a translucent screen, set the "Projection" command in the "Extended" menu to match the installation method.

[p.36](#)

This section describes maintenance tasks such as cleaning the projector and replacing consumable parts.

Cleaning

You should clean the projector if it becomes dirty or if the quality of projected images starts to deteriorate.

CAUTION *Make sure you read the separate Safety Instructions/ World-Wide Warranty Terms before cleaning.*

Cleaning the Projector's Surface

Clean the projector's surface by wiping it gently with a soft cloth. If the projector is particularly dirty, moisten the cloth with water containing a small amount of neutral detergent, and then firmly wring the cloth dry before using it to wipe the projector's surface. Then wipe it again with a soft, dry cloth.

CAUTION *Do not use volatile substances such as wax, alcohol or thinner to clean the projector's surface. These can cause the projector to warp and make the coating finish peel off.*

Cleaning the Lens

Use a commercially-available air blower, or use a lens cleaning paper to gently wipe the lens.

CAUTION *Do not rub the lens with harsh materials or subject the lens to shocks, as it can easily become damaged.*

Cleaning the Air Filters and Air Intake Vent

If dust collects on the air filter or the air outlet, it can cause the internal temperature of the projector to rise, and this can lead to problems with operation and shortening of the optical engine's service life. It is recommended that you clean these parts at least once every three months. Clean them more often than this if using the projector in particularly dusty environments.

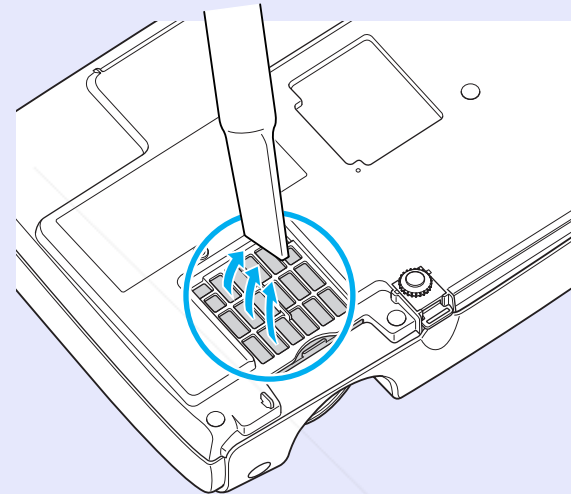

TIP

If the air filters are broken or if the warning message reappears after they have been cleaned, they should be replaced. Replace with a new air filter. See "Replacing the Air Filter". [p.62](#)



FixYourDLP.com

Sponsored by

Discount-Merchant.com (800) 281-8860

THE TRUSTED SOURCE FOR PROJECTOR LAMPS AND ACCESSORIES

Replacing Consumables

This section explains how to replace the remote control batteries, the lamp, and the air filters.

Replacing the batteries

If delays in the responsiveness of the remote control occur or if it does not operate after it has been used for some time, it probably means that the batteries are becoming flat. Replace the batteries. Have two spare AAA-size alkali batteries ready to use when required.

CAUTION

Make sure you read the Safety Instructions/World-Wide Warranty Terms before handling the batteries.

PROCEDURE

1 Remove the battery cover.

While pushing the catch of the battery compartment cover, lift the cover up.

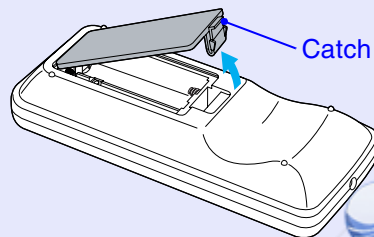

2

Insert the batteries.

Check the positions of the (+) and (-) marks inside the battery holder to ensure that the batteries are inserted the correct way.

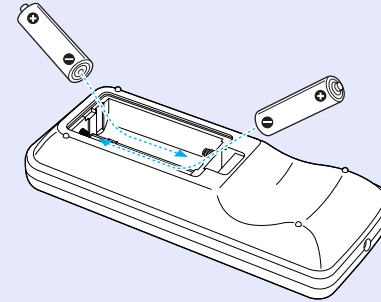

3

Replace the battery cover.

Press the battery compartment cover until it clicks into place.

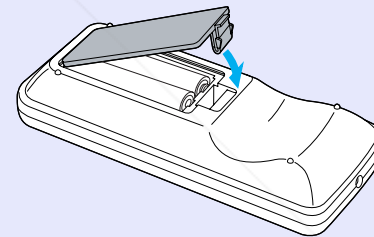

Lamp Replacement Period

It is time to replace the lamp when:

- The message "Replace the Lamp." appears on the screen when projection starts

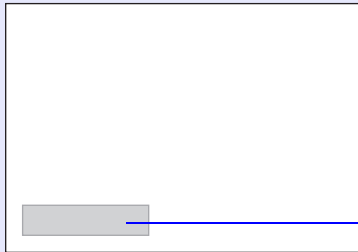

A message will be displayed.

- When the Lamp indicator is flashing orange

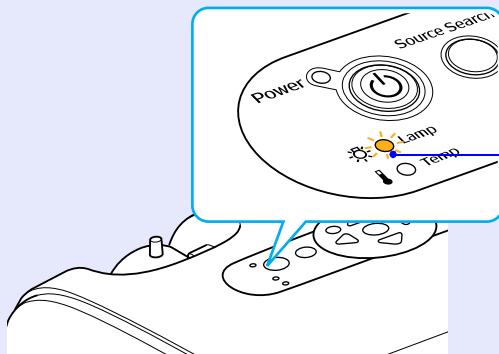

Flashing orange

- The projected image gets darker or starts to deteriorate



TIP

- *The lamp replacement message is set to appear after the following periods of time in order to maintain the initial brightness and quality of the projected images. "Brightness Control" p.35*
 - *When used continuously at high brightness: Approx. 1900 hours*
 - *When used continuously at low brightness: Approx. 2900 hours*
- *If you continue to use the lamp after this period, the possibility of the lamp breaking becomes greater. When the lamp replacement message appears, replace the lamp with a new one as soon as possible, even if it is still working.*
- *Depending on the characteristics of the lamp and on the way it has been used, the lamp may become darker or stop working before the lamp warning message appears. You should always have a spare lamp ready in case it is needed.*
- *Contact your dealer for a spare lamp.*

Replacing the Lamp

CAUTION

- *If you are replacing the lamp because it has stopped working, it is possible that the lamp is broken. If replacing the lamp of a projector which has been installed on a ceiling, you should always assume that the lamp is broken and be extremely careful when removing the lamp cover.*
- *Wait until the lamp has cooled down sufficiently before removing the lamp cover. To give the lamp enough time to cool down after turning off the power, wait for about one hour.*



PROCEDURE

- 1 After you turn off the projector's power, and the confirmation buzzer beeps twice, disconnect the power cable.

- 2 Wait until the lamp has cooled down, then remove the lamp cover from the base of the projector.

Loosen the lamp cover fixing screw with the screwdriver that is supplied with the spare lamp (or your own cross head screwdriver).

Then slide the lamp cover straight forward and lift it to remove.

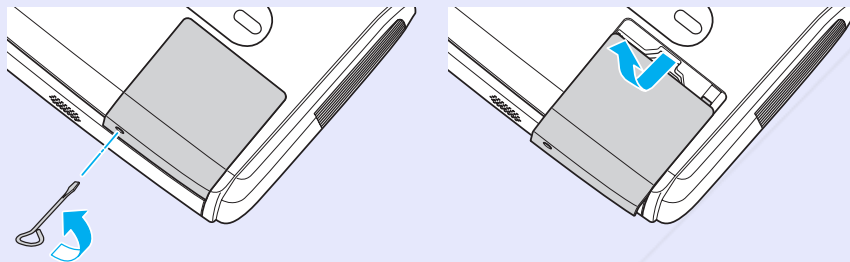

- 3 Loosen the two lamp fixing screws.

Loosen the two lamp fixing screws with the screwdriver that is supplied with the spare lamp (or your own cross head screwdriver).

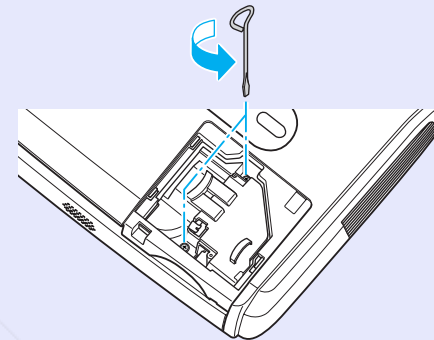

- 4 Take out the lamp.

Hold the lamp as shown in the illustration below and lift it up and out of the projector. If the lamp is broken replace it with a new lamp, or contact your local dealer for further advice. If replacing the lamp yourself, be careful to avoid pieces of broken glass.

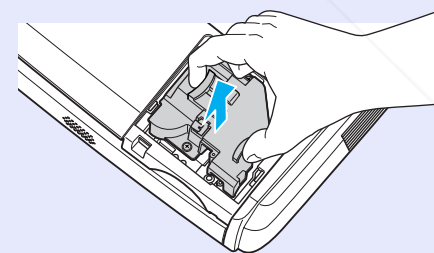

5 Install the new lamp.

Insert the new lamp so that the lamp fits in place correctly and once it is fully inserted, tighten the two screws.

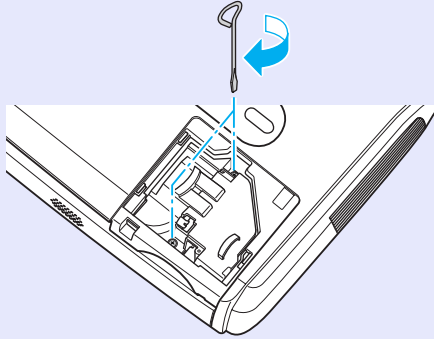
**6** Install the lamp cover.

Slide the lamp cover and tighten the cover fixing screws.

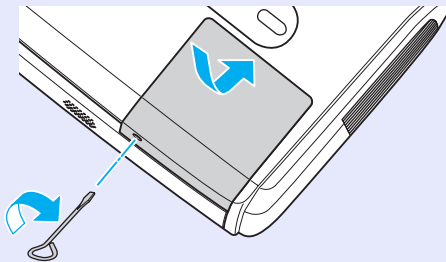

TIP

- *Install the lamp securely. If the lamp cover is removed, the lamp turns off automatically as a safety precaution. Moreover, the lamp will not turn on if the lamp or the lamp cover is not installed correctly.*
- *The lamp contains mercury. Dispose of used lamps properly in accordance with your local regulations.*

DiscountMerchant.com (800) 281-8860
THE TRUSTED SOURCE FOR PROJECTOR LAMPS AND ACCESSORIES



Resetting the Lamp Operating Time

The projector has a built-in counter which keeps track of the lamp operating time. When the cumulative operating time reaches a certain point, it causes the replacement warning message to be displayed. Therefore, the counter needs to be reset after the lamp has been replaced with a new one. You can do this using the configuration menu.



TIP

Do not reset the lamp operating time except after the lamp has been replaced, otherwise the lamp replacement period will not be indicated correctly.

PROCEDURE

1 Connect the power cable and turn on the projector.

2

Select "Reset" from the configuration menu, and then select "Lamp-Hours reset".

For details on this operation, refer to "Using the Configuration Menu".  p.32

Check the buttons you can use, and the operations they perform, in the guide at the bottom of the screen.

Using the remote control

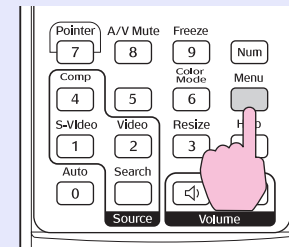

Using the control panel

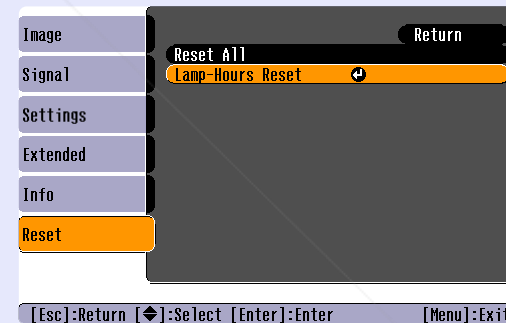
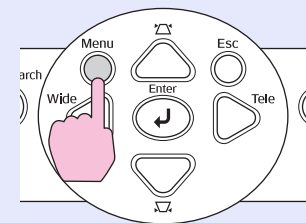

3

When "Execute?" appears, select "Yes".

The lamp operating time will then be reset.

■ Replacing the Air Filter

If the air filters are broken or if the warning message reappears after they have been cleaned, they should be replaced.

The air filter can be replaced even if the projector is installed on a ceiling.

PROCEDURE

1 After you turn off the projector's power, and the confirmation buzzer beeps twice, disconnect the power cable.

2 Remove the air filter.
Put your finger into the recess of the air filter and slide it forward to remove it.

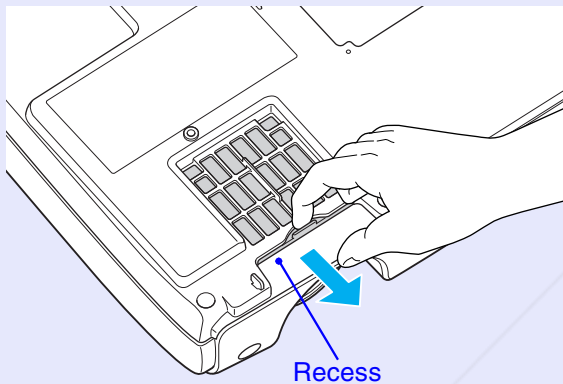

3 Install the new air filter.
Slide the air filter covers in from the outside and push them in until they click into place.

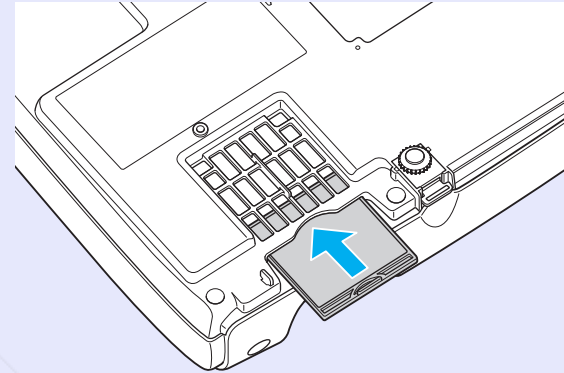

TIP

Dispose of used air filters properly in accordance with your local regulations.

*Air filter frame: Polycarbonate, ABS plastic
Filter: Polyurethane foam*

You can record the image that is currently being projected as a user's logo.



When a user's logo is recorded, the previous user's logo will be erased.

PROCEDURE

- 1 Project the image you would like to use as the user's logo, and then display the configuration menu.

Using the remote control

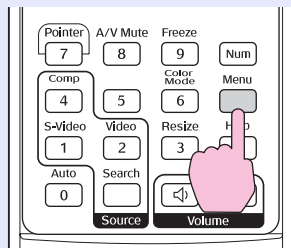

Using the control panel

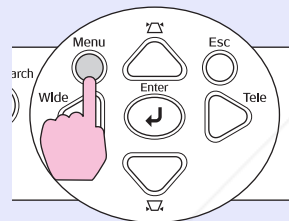

- 2 Select "Extended" from the configuration menu, and then select "User's Logo".

For details on this operation, refer to "Using the Configuration Menu". [p.32](#)

Check which buttons on the remote control or the control panel you can use, and the operations they perform, in the guide at the bottom of the screen.

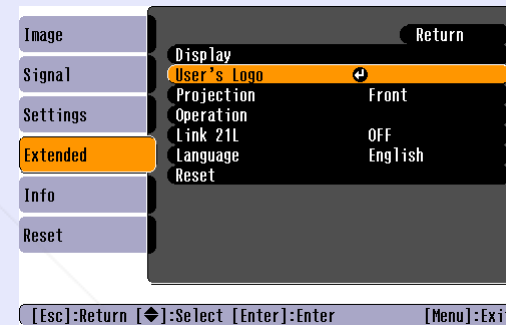

- If the "User's Logo Protect" function of "Password Protect" is set to "ON", a message is displayed and the user's logo can not be recorded. To record a user's logo, set "User's Logo Protect" to "OFF" first. [p.28](#)
- If keystone correction, Zoom adjustment, or E-Zoom and so on, have been carried out, the function currently being performed is cancelled when the "User's Logo" menu is selected.



- When "Choose this image as the User's Logo?" appears, select "Yes".



TIP

When you press the [Enter] button on either the remote control or the projector's control panel, the image signal will be displayed at their original resolution, so if a signal with a resolution that is different from the panel resolution of the projector is projected, or if a video image is being projected, the display size will change.

- The image to be recorded and a selection marquee box will be displayed. Move the marquee box to select the part of the image to use.



Using the remote control

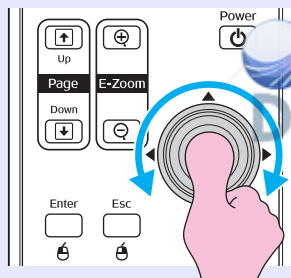

Using the control panel

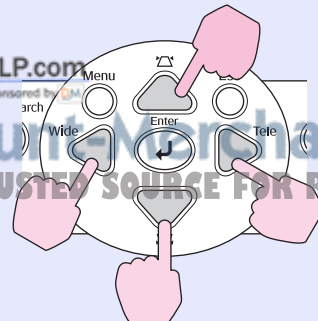

TIP

User's logos can be saved at up to 400 × 300 dots in size.

- When "Select this image?" appears, select "Yes".
- Select the zoom rate from the Zoom rate setting screen.

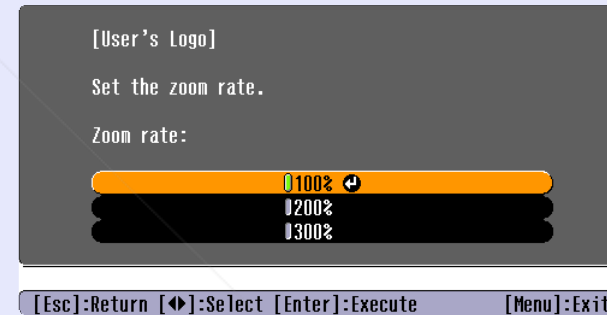

- When "Save this image?" is displayed, select "Yes". The image will then be saved. Once the image has been saved, the message "Completed." will be displayed.



TIP

- Saving the user's logo may take a few moments (about 15 seconds). Do not use the projector or any other sources which are connected to the projector while the user's logo is being saved, otherwise it may result in errors in projector operation.
- Once a user's logo has been saved, the logo setting cannot be returned to the factory default.

While performing presentations and so on, you can check analogue RGB images and RGB video images from a computer being input to the "Computer/Component Video" terminal by connecting an external monitor to this projector.

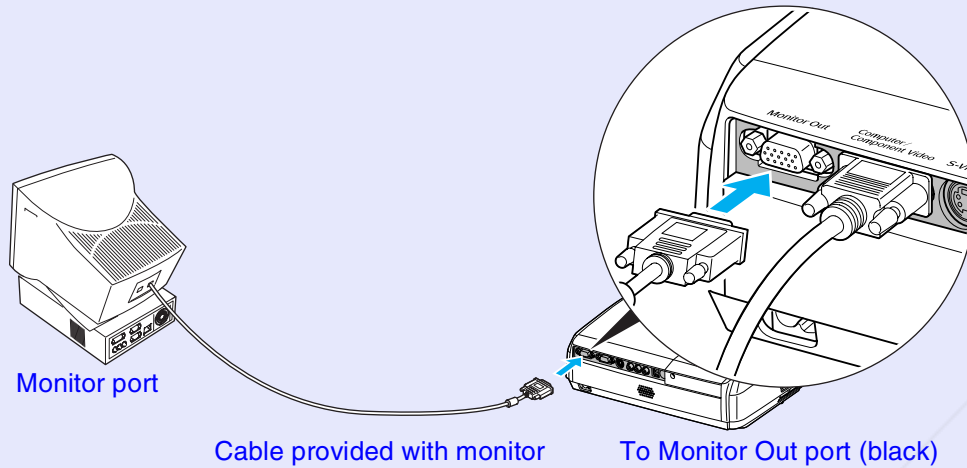

TIP

- *Component video, S-Video, and component video images cannot be output to an external monitor.*
- *The setting gauge for keystone correction and the configuration menus and help menus are not output to the external monitor.*



FixYourDLP.com

Sponsored by 

Discount-Merchant.com (800) 281-8860

THE TRUSTED SOURCE FOR PROJECTOR LAMPS AND ACCESSORIES

The following optional accessories are available for purchase if required. This list of optional accessories is current as of April, 2005. Details of accessories are subject to change without notice. Varies depending on country of purchase.

■ Optional Accessories

Soft carrying case ELPKS16

Use this case if you need to carry the projector by hand.

60" screen ELPSC07

80" screen ELPSC08

100" screen ELPSC10

Portable roll-type screens. ([Aspect ratio](#)▶▶ 4:3)

50" portable screen ELPSC06

A compact screen which can be carried easily. (Aspect ratio 4:3)

VGA-HD15 PC cable ELPKC02

(1.8 m (6 ft.) - for mini D-Sub 15-pin/mini D-Sub 15-pin)

This is the same as the computer cable supplied with the projector.

VGA-HD15 PC cable ELPKC09

(3 m (9.8 ft.) - for mini D-Sub 15-pin/mini D-Sub 15-pin)

VGA-HD15 PC cable ELPKC10

(20 m (65.6 ft.) - for mini D-Sub 15-pin/mini D-Sub 15-pin)

Use one of these longer cables if the computer cable supplied with the projector is too short.

Component video cable ELPKC19

(3 m (9.8 ft.) - for mini D-Sub 15-pin/RCA male × 3)

Use to connect a [component video](#)▶▶ source.

Ceiling mount * ELPMB18

Use when installing the projector on a ceiling.

Ceiling plate* ELPFC03

Pipe 370 (370 mm (14.57 in.)/silver)* ELPFP04

Pipe 570 (570 mm (22.44 in.)/silver)* ELPFP05

Pipe 770 (770 mm (30.31 in.)/silver)* ELPFP06

Use when installing the projector on a high ceiling or a ceiling with veneer panels.

* A special method of installation is required in order to suspend the projector from a ceiling. Please contact your dealer if you would like to use this installation method.

■ Consumables

Spare lamp ELPLP33

Use as a replacement for used lamps.

Filter kit ELPAF08

(2 air filters)

Use as a replacement for used air filters.

The following is an explanation of some of the terms used in this guide which may be unfamiliar or which are not explained in the text of this guide itself. Further information can be obtained by referring to other commercially-available publications.

Aspect ratio	The ratio between an image's length and its height. HDTV images have an aspect ratio of 16:9 and appear elongated. The aspect ratio for standard images is 4:3.
Color Temp.	The temperature of an object that is emitting light. If the colour temperature is high, the colours take on a bluish tinge. If the colour temperature is lower, the colours take on a reddish tinge.
Component video	Video signals which have the video brightness signals and colour signals separated, in order to provide better image quality. In high-definition TV (HDTV), it refers to images which consist of three independent signals: Y (luminance signal), and Pb and Pr (colour difference signals).
Composite video	Video signals which have the video brightness signals and colour signals mixed together. The type of signals commonly used by household video equipment (NTSC, PAL and SECAM formats). The carrier signal Y (luminance signal) and chroma (colour) signal which are contained in the colour bar are overlapped to form a single signal.
Contrast	The relative brightness of the light and dark areas of an image can be increased or decreased in order to make text and graphics stand out more clearly, or to make them appear softer. Adjusting this particular property of an image is called "contrast adjustment".
Dolby Digital	A sound format developed by Dolby Laboratories. Normal stereo is a 2-channel format which uses two speakers. Dolby Digital is a 6-channel (5.1-channel) system which adds to this a centre speaker two rear speakers and a sub-woofer.
HDTV	An abbreviation for High-Definition Television. It refers to high-definition systems which satisfy the following conditions. <ul style="list-style-type: none"> • Vertical resolution of 750p or 1125i or greater (p = progressive, i = interlaced) • Screen aspect ratio of 16:9 • Dolby Digital audio reception and playback (or output)
Interlaced	A method of image scanning whereby the image data is divided into fine horizontal lines which are displayed in sequence starting from left to right and then from the top to the bottom of the screen. The even-numbered lines and odd-numbered lines are displayed alternately.
Progressive	A method of image scanning whereby the image data from a single image is scanned sequentially from top to bottom to create a single image.
Refresh rate	The light-emitting element of a display maintains the same luminosity and colour for an extremely short time. Because of this, the image must be scanned many times per second in order to refresh the light-emitting element. The number of refresh cycles per second is called the "refresh rate", and is expressed in hertz (Hz).
SDTV	An abbreviation for Standard Definition Television. It refers to standard television systems which do not satisfy the conditions for High-Definition Television.
Security lock	A device consisting of a projector case with a hole in it that a commercially-available theft-prevention cable can be passed through in order to secure the device to a table or pillar. This projector is compatible with the Microsaver Security System manufactured by Kensington.



Squeeze mode	In this mode, wide-screen images in 16:9 mode are compressed in the horizontal direction so that they are stored on the recording medium as 4:3 images. When these images are played back by the projector in squeeze mode, they are restored to their original 16:9 format.
sRGB	An international standard for colour intervals that was formulated so that colours which are reproduced by video equipment can be handled easily by computer operating systems (OS) and the Internet. If the connected source has a sRGB mode, set both the projector and the connected signal source to sRGB.
SVGA	A type of video signal with a resolution of 800 (horizontal) × 600 (vertical) dots which is used by IBM PC/AT-compatible computers.
S-Video	A video signal which has the luminance component and colour component separated in order to provide better image quality. It refers to images which consist of two independent signals: Y (luminance signal), and C (colour signal).
SXGA	A type of video signal with a resolution of 1280 (horizontal) × 1024 (vertical) dots which is used by IBM PC/AT-compatible computers.
Sync (synchronisation)	The signals output from computers and RGB video equipment have a specific frequency. If the projector frequency does not match this frequency, the resulting images will not be of a good quality. The process of matching the phases of these signals (the relative position of the crests and troughs in the signal) is called "synchronisation". If the signals are not synchronized, problems such as flickering, blurriness and horizontal interference can occur.
Tracking	The signals output from computers and RGB video equipment have a specific frequency. If the projector frequency does not match this frequency, the resulting images will not be of a good quality. The process of matching the frequency of these signals (the number of crests in the signal) is called "tracking". If tracking is not carried out correctly, wide vertical stripes will appear in the projected images.
USB	An abbreviation for Universal Serial Bus. USB is an interface for connecting personal computers to peripheral devices which only support relatively low data transmission speeds.
VGA	A type of video signal with a resolution of 640 (horizontal) × 480 (vertical) dots which is used by IBM PC/AT-compatible computers.
XGA	A type of video signal with a resolution of 1024 (horizontal) × 768 (vertical) dots which is used by IBM PC/AT-compatible computers.



Command List

When a power on command is sent to the projector, the power will turn on and the projector will change to warm-up mode. When the power has turned on, a colon ":" (3Ah) will be returned.

When the projector executes a command, it returns a ":" and waits for the next command to be sent.

If command processing terminates with an error, the projector outputs an error message and then returns the ":" code.

	Item	Command
Power ON/OFF	ON	PWR ON
	OFF	PWR OFF
Signal selection	Computer (Auto)	SOURCE 1F
	Computer	SOURCE 11
	Component Video	SOURCE 14
	Video	SOURCE 41
	S-Video	SOURCE 42
A/V Mute ON/OFF	ON	MUTE ON
	OFF	MUTE OFF
A/V Mute Selection	Black	MSEL 00
	Blue	MSEL 01
	User's Logo	MSEL 02

* When issuing any of the above commands, tack a Carriage Return (CR) code (0Dh) on to the end.

Cable Layouts

■ USB connection

Connector shape: USB (type B)

<At the projector>

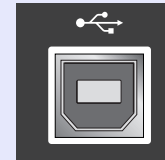

(type B)

<At the computer>

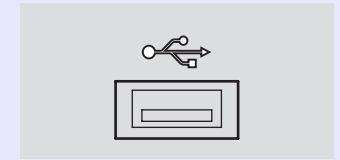

USB Connection Setup

In order to control the projector using ESC/VP21 commands via a USB connection, the following preparations must be carried out.

PROCEDURE

- 1 Download the USB driver (USB-COM Driver) from the EPSON website to your computer.**
The URL is as follows.
<http://www.epson.co.uk/support/download/index.htm>
- 2 Install the downloaded USB driver onto your computer.**
Read the instructions displayed on the download screen.
- 3 Change the "Link21L" setting in the "Extended" menu to "ON".**
- 4 Turn the projector's power off.**
- 5 Turn off this projector after the confirmation buzzer beeps twice.**

Once the projector's power has turned back on, communication via a USB Connection will then be possible.

CAUTION

If you disconnect the power cable before the confirmation buzzer beeps twice, the communication port is not changed.

FixYourDLP.com

Sponsored by

uscount.com (800) 281-8860
THE TRUSTED SOURCE FOR PROJECTOR LAMPS AND ACCESSORIES

■ Computer/RGB Video

Signal	Refresh rate▶ (Hz)	Source Resolution (dots)	Projected Resolution*2 (dots)	
			Aspect ratio▶	Aspect ratio
VGA▶	60	640×480	800×600	
VGAEGA		640×350	800×438	
VESA	60/72/75/85,iMac*1	640×480	800×600	
SVGA▶	56/60/72/75/85,iMac*1	800×600	800×600	
XGA▶	60/70/75/85,iMac*1	1024×768	800×600	
SXGA▶	70/75/85	1152×864	800×600	
SXGA	60/75/85	1280×960	800×600	
SXGA	60/75/85	1280×1024	750×600	
MAC13"		640×480	800×600	
MAC16"		832×624	800×600	
MAC19"		1024×768	800×600	
MAC19"	60	1024×768	800×600	
MAC21"		1152×870	794×600	
SDTV▶ (625i)	50	720×576	800×600	
SDTV(525i)	60	720×480	800×600	
SDTV(525p)	60	640×480	800×600	
HDTV▶ (750p)	60	1280×720	800×450	
HDTV(1125i)	60	1920×1080	800×450	

*1:Connection is not possible if the equipment does not have a VGA output port.

*2:Maximum Zoom

The projection of some signals not listed in the table may still be possible. However, not all functions may be supported.

■ Component Video/RGB Video

Signal	Refresh rate▶ (Hz)	Resolution (dots)*2	
		Aspect ratio▶	Aspect ratio
SDTV▶ (525i) (D1)	60	800×600	800×450
SDTV (625i)	50	800×600	800×450
SDTV (525p) (D2)	60	800×600	800×450
HDTV▶ (750p) 16:9 (D4)	60	800×600	800×450
HDTV (1125i) 16:9 (D3)	60	800×600	800×450

■ Composite Video/S-Video

Signal	Refresh rate▶ (Hz)	Resolution (dots)*2	
		Aspect ratio▶	Aspect ratio
TV (NTSC)	60	800×600	800×450
TV (PAL, SECAM)	50	800×600	800×450

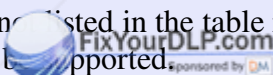

Product name	Multimedia Projector EMP-S3		
Dimensions	327 (W) × 86 (H) × 246 (D) mm (not including feet)		
Panel size	0.5 inches		
Display method	Polysilicon TFT active matrix		
Resolution	SVGA 480,000 pixels (800 (W) × 600 (H) dots) × 3		
Focus adjustment	Manual		
Zoom adjustment	Electronic (approx. 1:1.35)		
Lamp (light source)	UHE lamp, 135 W, Model No.: ELPLP33		
Max. audio output	1W monaural		
Speaker	1		
Power supply	100-240VAC 50/60Hz 2.2-1.0A Power Consumption Operating: 200W(100 to 240 V area) Standby : 4.8W(100 to 240 V area)		
Operating temperature	+5°– +35°C (41°–95°F) (No condensation)		
Storage temperature	-10°– +60°C (14°–140°F) (No condensation)		
Weight	Approx. 2.5 kg		
Connectors	Computer	1	Mini D-Sub 15-pin (female) Blue
	S-Video	1	Mini DIN 4-pin
	Video	1	RCA pin jack
	Audio Input	1	RCA pin jack×2 (L,R)
	USB*	1	USB connector (B series)
	Monitor Out	1	Mini D-Sub 15-pin (female) Black

* The USB interface complies with the USB 1.1 standard.
The USB connector is not guaranteed to operate correctly with all USB-compatible devices.



Pixelworks DNX™ ICs are used in this Projector.

Angle of tilt

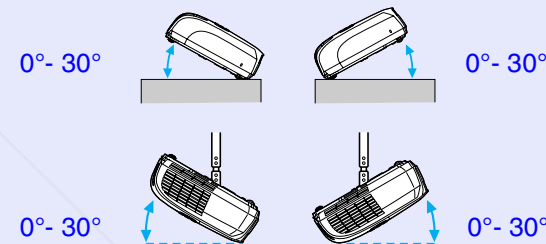

If you set the projector higher than 30°, it could damage the projector and cause an accident.

Safety

USA
UL60950 Third Edition
Canada
CSA C22.2 No.60950
European Community
The Low Voltage Directive (73/23/EEC)
IEC60950 3rd Edition

EMC

USA
FCC Part 15B Class B (DoC)
Canada
ICES-003 Class B
European Community
The EMC Directive (89/336/EEC)
EN55022, 1998 Class B
EN55024, 1998
IEC/EN61000-3-2
IEC/EN61000-3-3

Australia/New Zealand
AS/NZS CISPR 22:2002 Class B

FixYourPC.com
Discount-Mechant.com (800) 281-8860
THE TRUSTED SOURCE FOR PROJECTOR LAMPS AND ACCESSORIES

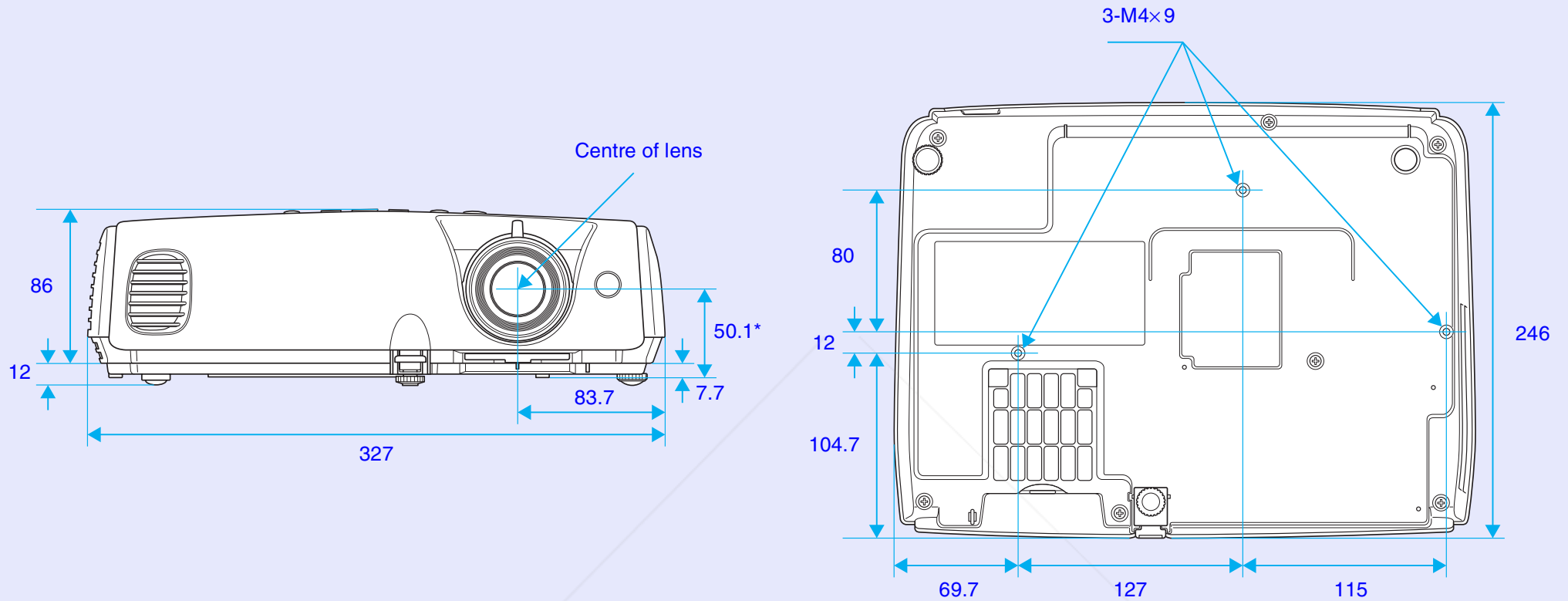

*Distance from center of lens to suspension bracket fixing point

Units: mm

A

- Air exhaust vent..... 6
- Air filter 9
- Air intake vent 9
- Angle of tilt..... 72
- Aspect ratio..... 21
- Audio input..... 8
- Auto Setup 12, 34
- A/V Mute..... 20

B

- Background Color 36
- Blackboard..... 14
- Brightness 33
- Brightness Control..... 35

C

- Cleaning the Air Filter 56
- Cleaning the Lens 56
- Cleaning the Projector Surface.... 56
- Color Intensity 33
- Color Mode..... 14, 31
- Color Temp..... 33
- Computer Input..... 34
- Computer port..... 8
- Configuration Menu 32
- Connectors..... 8

- Consumables 66
- Contrast 33
- Control Panel..... 7
- Cross..... 23

D

- DirectPower ON..... 37
- Display 36

E

- ESC/VP21 69
- "Extended" Menu 36
- E-Zoom 22

F

- Fan Speed 37
- Focus ring..... 6
- Freeze 20
- Front adjustable foot 6

G

- Glossary..... 67

H

- HDTV 71

- Help function 41

I

- "Image" Menu..... 33
- Image Shift..... 16, 35
- Indicator 43
- "Info" Menu 38
- Input Signal..... 38

K

- Keystone 35

L

- Lamp cover 6
- Lamp Hours 38
- Lamp-Hours Reset 39, 61
- Lamp indicator..... 44
- Lamp replacement period 58
- Language..... 37
- Lens cover..... 6
- Link 21L 37
- Low 35

M

- Menu 32
- Message 36

- Monitor Out port 8
- Mouse pointer..... 24

N

- Numeric buttons 10

O

- Operating temperature..... 72
- Operation..... 37
- Operation Lock..... 29, 35
- Optional accessories..... 66
- Overheating 44

P

- Part Names and Functions..... 6
- Password Protect 26
- Password Protect stickers 27
- Photo..... 14
- Pointer 21
- Pointer Shape..... 35
- Position..... 12, 34
- Power indicator 43
- Power inlet..... 8
- Power ON Protect..... 26
- Presentation 14
- Problem Solving..... 43
- Progressive 34

FixYourDLP.com
Sponsored by 
Discount-Merchant.com (800) 281-8860
THE TRUSTED SOURCE FOR PROJECTOR LAMPS AND ACCESSORIES



Projection..... 36

R

Rear adjustable foot..... 8

Refresh Rate 38

Remote control 10, 23

Remote control light-emitting
area..... 10

Remote control light-receiving
area..... 6, 8

Replacing the Air Filter 62

Replacing the batteries 57

Replacing the Lamp..... 58

Request code..... 26

Reset All 39

"Reset" Menu..... 39

Resolution..... 38, 71

S

Search 10

Security lock..... 6

"Settings" Menu..... 35

Setting Up the Projector 51

Sharpness..... 33

"Signal" Menu 34

Sleep Mode..... 37

Source 38

Source Search 7, 18

Speaker..... 8

Specifications 72

Sports..... 14

Squeeze mode..... 21

sRGB 14

Startup Screen 36

Storage temperature 72

Sub menu..... 32

Supported Monitor Displays 71

Suspension bracket
fixing point 9, 73

S-Video port 8

Sync..... 13, 34

Sync. Info 38

T

Temp indicator 44

Theatre..... 14

Tint 33

Top menu 32

Tracking 12, 34

Translucent screen..... 55

U
Sponsored by 

USB connection 70

USB port..... 8

User's Logo..... 63

User's Logo Protect..... 27

V

Video port 8

Video Signal 34, 38

Volume 17, 35

W

Wide-screen Projection..... 21

Wireless Mouse 23

Z

Zoom..... 35



FixYourDLP.com
Sponsored by 

Discount-Merchant.com (800) 281-8860

THE TRUSTED SOURCE FOR PROJECTOR LAMPS AND ACCESSORIES



DECLARATION of CONFORMITY

According to 47CFR, Part 2 and 15
Class B Personal Computers and Peripherals; and/or
CPU Boards and Power Supplies used with Class B
Personal Computers

We :EPSON AMERICA, INC.
Located at :3840 Kilroy Airport Way
MS: 3-13
Long Beach, CA 90806
Tel :562-290-5254

Declare under sole responsibility that the product identified herein, complies with 47CFR Part 2 and 15 of the FCC rules as a Class B digital device. Each product marketed, is identical to the representative unit tested and found to be compliant with the standards. Records maintained continue to reflect the equipment being produced can be expected to be within the variation accepted, due to quantity production and testing on a statistical basis as required by 47CFR 2.909. Operation is subject to the following two conditions : (1) this device may not cause harmful interference, and (2) this device must accept any interference received, including interference that may cause undesired operation.

Trade Name :EPSON
Type of Product :Projector
Model :EMP-S3



Discount-Merchant.com (800) 281-8860
THE TRUSTED SOURCE FOR PROJECTOR LAMPS AND ACCESSORIES

**FCC Compliance Statement
For United States Users**

This equipment has been tested and found to comply with the limits for a Class B digital device, pursuant to Part 15 of the FCC Rules. These limits are designed to provide reasonable protection against harmful interference in a residential installation. This equipment generates, uses, and can radiate radio frequency energy and, if not installed and used in accordance with the instructions, may cause harmful interference to radio or television reception. However, there is no guarantee that interference will not occur in a particular installation. If this equipment does cause interference to radio and television reception, which can be determined by turning the equipment off and on, the user is encouraged to try to correct the interference by one or more of the following measures.

- Reorient or relocate the receiving antenna.
- Increase the separation between the equipment and receiver.
- Connect the equipment into an outlet on a circuit different from that to which the receiver is connected.
- Consult the dealer or an experienced radio/TV technician for help.

WARNING

The connection of a non-shielded equipment interface cable to this equipment will invalidate the FCC Certification or Declaration of this device and may cause interference levels which exceed the limits established by the FCC for this equipment. It is the responsibility of the user to obtain and use a shielded equipment interface cable with this device. If this equipment has more than one interface connector, do not leave cables connected to unused interfaces. Changes or modifications not expressly approved by the manufacturer could void the user's authority to operate the equipment.

All rights reserved. No part of this publication may be reproduced, stored in a retrieval system, or transmitted in any form or by any means, electronic, mechanical, photocopying, recording, or otherwise, without the prior written permission of SEIKO EPSON CORPORATION. No patent liability is assumed with respect to the use of the information contained herein. Neither is any liability assumed for damages resulting from the use of the information contained herein.

Neither SEIKO EPSON CORPORATION nor its affiliates shall be liable to the purchaser of this product or third parties for damages, losses, costs, or expenses incurred by the purchaser or third parties as a result of: accident, misuse, or abuse of this product or unauthorized modifications, repairs, or alterations to this product, or (excluding the U.S.) failure to strictly comply with SEIKO EPSON CORPORATION's operating and maintenance instructions.

SEIKO EPSON CORPORATION shall not be liable against any damages or problems arising from the use of any options or any consumable products other than those designated as Original EPSON Products or EPSON Approved Products by SEIKO EPSON CORPORATION.

General Notice:

EPSON is a registered trademark of SEIKO EPSON CORPORATION. Macintosh, Mac, and iMac are registered trademarks of Apple Computer, Inc.

IBM is a registered trademark of International Business Machines Corporation.

Windows and Windows NT are trademarks of Microsoft Corporation in the United States of America.

Dolby is a registered trademark of Dolby Laboratories.

Pixelworks and DNX are trademarks of Pixelworks, Inc.

Other product names used herein are also for identification purposes only and may be trademarks of their respective owners. EPSON disclaims any and all rights in those marks.

This product uses open source software.

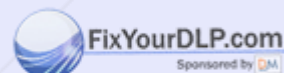

Discount-Merchant.com (800) 281-8860
THE TRUSTED SOURCE FOR PROJECTOR LAMPS AND ACCESSORIES



Disclaimer

This user manual is provided as a free service by FixYourDLP.com. FixYourDLP is in no way responsible for the content of this manual, nor do we guarantee its accuracy. FixYourDLP does not make any claim of copyright and all copyrights remain the property of their respective owners.

About FixYourDLP.com

FixYourDLP.com (<http://www.fixyourdpl.com>) is the World's #1 resource for media product news, reviews, do-it-yourself guides, and manuals.

Informational Blog: <http://www.fixyourdpl.com>

Video Guides: <http://www.fixyourdpl.com/guides>

User Forums: <http://www.fixyourdpl.com/forum>

FixYourDLP's Fight Against Counterfeit Lamps:

<http://www.fixyourdpl.com/counterfeits>

Sponsors:

RecycleYourLamp.org – Free lamp recycling services for used lamps:

<http://www.recycleyourlamp.org>

Lamp Research - The trusted 3rd party lamp research company:

<http://www.lampresearch.com>

Discount-Merchant.com – The worlds largest lamp distributor:

<http://www.discount-merchant.com>



FixYourDLP.com

Sponsored by 