



# Disclaimer

This user manual is provided as a free service by FixYourDLP.com. FixYourDLP is in no way responsible for the content of this manual, nor do we guarantee its accuracy. FixYourDLP does not make any claim of copyright and all copyrights remain the property of their respective owners.

About FixYourDLP.com

FixYourDLP.com (<http://www.fixyourdpl.com>) is the World's #1 resource for media product news, reviews, do-it-yourself guides, and manuals.

Informational Blog: <http://www.fixyourdpl.com>

Video Guides: <http://www.fixyourdpl.com/guides>

User Forums: <http://www.fixyourdpl.com/forum>

FixYourDLP's Fight Against Counterfeit Lamps:

<http://www.fixyourdpl.com/counterfeits>

## Sponsors:

RecycleYourLamp.org – Free lamp recycling services for used lamps:

<http://www.recycleyourlamp.org>

Lamp Research - The trusted 3rd party lamp research company:

<http://www.lampresearch.com>

Discount-Merchant.com – The worlds largest lamp distributor:

<http://www.discount-merchant.com>



**FixYourDLP.com**

Sponsored by 

# EPSON®

## Owner's Manual

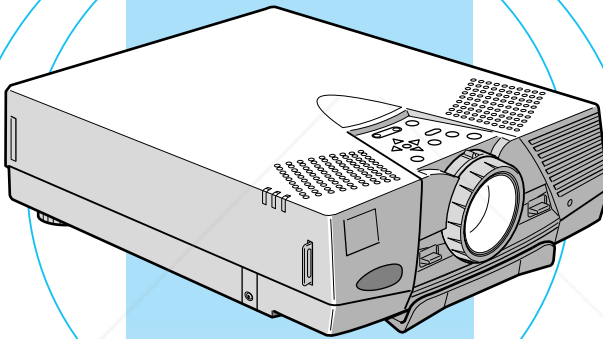

 **FixYourDLP.com**  
Sponsored by 

**Discount-Merchant.com (800) 281-8860**

THE TRUSTED SOURCE FOR PROJECTOR LAMPS AND ACCESSORIES

# EMP-7500/5550/5500™

**MM PROJECTOR**  
ULTI EDIA EMP-7500/5550/5500

**DECLARATION of CONFORMITY/DICHIARAZIONE di CONFORMITÀ/  
KONFORMITÄSERKLÄUNG/DECLARACIÓN de CONFORMIDAD/DECLARATION  
de CONFORMITE**

according to ISO/IEC Guide 22 and EN 45014/secondo la Guida ISO/IEC 22 e EN 450014/entsprechend ISO/  
CEI Anleitung 22 und EN 45014/De acuerdo con ISO/IEC Guide 22 y EN 45014/selon les normes ISO/IEC  
Guide 22 et EN45014

Manufacturer/Produttore/Hersteller/Fabricante/Constructeur  
SEIKO EPSON CORPORATION

Address/Indirizzo/Adresse/Dirección/Adresse  
3-5, Owa 3-chome, Suwa-shi, Nagano-ken 392-8502 Japan

Representative/Rappresentante/Vertreten durch/Representante/Représentant  
EPSON EUROPE B.V.

Address/Indirizzo/Adresse/Dirección/Adresse  
Prof. J.H.Bavincklaan 5 1183 AT Amstelveen  
The Netherlands

Declares that the Product/Dichiara che il prodotto/Erklärt hiermit, daß das Produkt/Declara  
que el producto/Déclare que le produit

Product name/Nome prodotto/Produktbezeichnung/Nombre del producto/Nom  
du produit LCD Projector

Model name/Nome modello/Modellbezeichnung/Nombre del modelo/Nom du  
modèle EMP-7500/5550/5500

Conforms to the following directives and Norms/Conforme alle seguenti direttive e  
Norme/Erfüllt die folgenden Direktiven und Normen/De acuerdo con las directrices y  
normas siguientes/Conforme aux directives et normes suivantes

**Directive 89/336/EEC**

- : EN 55022 Class B
- : EN 61000-3-2
- : EN 61000-3-3
- : EN 50082-1

**Directive 73/23/EEC**

EN 60950

Sponsored by 



July/Julii/Juillet/Juli/Luglio 1998

**Discount-Merchant.com (800) 281-8860**

**UNMATCHED SOURCE FOR PROJECTOR LAMPS AND ACCESSORIES**

H. HORIUCHI  
President of/Presidente della/Der Generaldirektor von/Presidente de/Président de  
Directeur van EPSON EUROPE B.V.

### **FCC Compliance Statement For United States Users**

This equipment has been tested and found to comply with the limits for a Class B digital device, pursuant to Part 15 of the FCC Rules. These limits are designed to provide reasonable protection against harmful interference in a residential installation. This equipment generates, uses, and can radiate radio frequency energy and, if not installed and used in accordance with the instructions, may cause harmful interference to radio or television reception. However, there is no guarantee that interference will not occur in a particular installation. If this equipment does cause interference to radio and television reception, which can be determined by turning the equipment off and on, the user is encouraged to try to correct the interference by one or more of the following measures.

- Reorient or relocate the receiving antenna.
- Increase the separation between the equipment and receiver.
- Connect the equipment into an outlet on a circuit different from that to which the receiver is connected.
- Consult the dealer or an experienced radio/TV technician for help.

### **WARNING**

The connection of a non-shielded equipment interface cable to this equipment will invalidate the FCC Certification or Declaration of this device and may cause interference levels which exceed the limits established by the FCC for this equipment. It is the responsibility of the user to obtain and use a shielded equipment interface cable with this device. If this equipment has more than one interface connector, do not leave cables connected to unused interfaces. Changes or modifications not expressly approved by the manufacturer could void the user's authority to operate the equipment.

### **For Canadian Users**

This digital apparatus does not exceed the Class B limits for radio noise emissions from digital apparatus as set out in the radio interference regulations of the Canadian Department of Communications.

Le présent appareil numérique n'émet pas de bruits radioélectriques dépassant les limites applicables aux appareils numériques de Classe B prescrites dans le règlement sur le brouillage radioélectrique édicté par le Ministère des Communications du Canada.



**Discount-Merchant.com (800) 281-8860**  
**THE TRUSTED SOURCE FOR PROJECTOR LAMPS AND ACCESSORIES**

# Important Information About Your projector

## Important Safety Information

**Warning:** *Never look into the projector lens when the lamp is switched on as the bright light can damage your eyes. Never let children look into the lens when it is on.*

**Warning:** *Never open any covers on the projector except the lamp and filter covers. Dangerous electrical voltages inside the projector can cause severe injury. Except as specifically directed in this Owner's Manual, do not attempt to service this product yourself. Refer all servicing to qualified service personnel.*

**Warning:** *Keep the plastic bags for the projector, accessories and optional parts out of the reach of children. Children covering their heads with bags may result in death by suffocation. Be particularly careful around small children.*

**Caution:** *When you replace the lamp, never touch the new bulb with your bare hands. The invisible residue left by the oil on your hands may be shorten the bulb life. Use a cloth or gloves to handle the new bulb.*



**Discount-Merchant.com (800) 281-8860**  
**THE TRUSTED SOURCE FOR PROJECTOR LAMPS AND ACCESSORIES**

# QUICK START

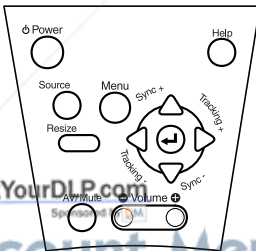
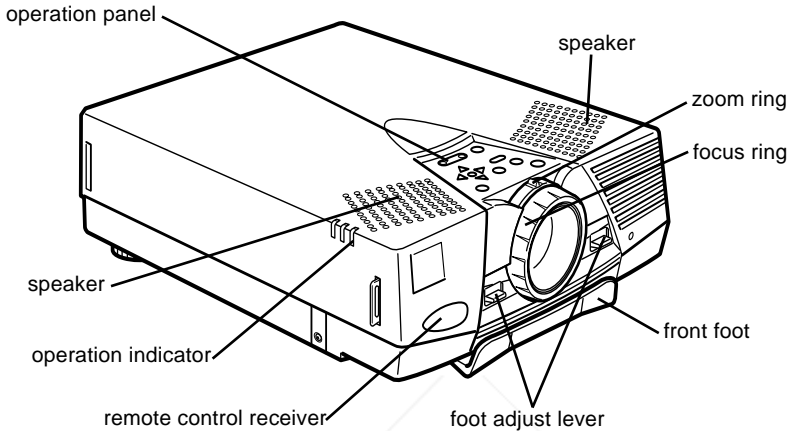

Operation Panel

Button	Function
Power	Turns the projector on or off.
Source	Switches the input source to Computer or Video.
Menu	Displays or hides the menu.
Up, down arrows (Sync+/Sync-)	Synchronizes the computer's graphic signal. Use these buttons to adjust an overall image that is fuzzy or streaked, or to select menu items during menu operations.
Left, right arrows (tracking-/tracking+)	Matches the projector's internal clock to various computer graphic signals (tracking adjustment). Use these buttons to adjust an image with vertical lines, or to change numeric settings during menu operations.
Enter button	Registers a menu selection.
Resize	Switches between Resizing screen and Window screen (PC input).
AV/Mute	Turns off the screen and sound of the projector temporarily.
- Volume +	Adjusts the volume.
Help	Displays the help menu for various types of problems you may encounter.

# QUICK START

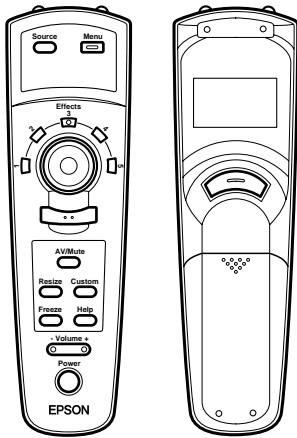

Remote control

Button	Function
Menu	Displays or hides the menu.
Source	Switches the input source to Computer or Video.
Effects buttons	Use to display special effects; 1 Pointer, 2 Box, 3 Line, 4 Marker, 5 Clear.
Top multi-purpose button	Acts as a right mouse click, registers a menu selection, and selects other custom functions.
Bottom multi-purpose button	Acts as a left mouse click, registers a menu selection, and selects other custom functions.
Help	Displays the help menu for various types of problems you may encounter.
Resize	Switches between Resizing screen and Window screen (PC input).
Custom	Zooms an image using the Mouse Right/Left buttons.
Freeze	Keeps the current computer or video image on the screen.
AV/Mute	Turns off the screen and sound of the projector temporarily.
- Volume +	Adjusts the volume.
Power	Turns the projector on or off.

## Connecting to a PC laptop computer

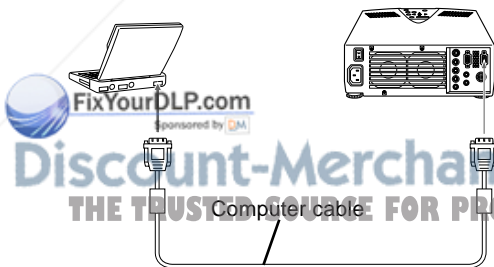

## Connecting to a Macintosh PowerBook

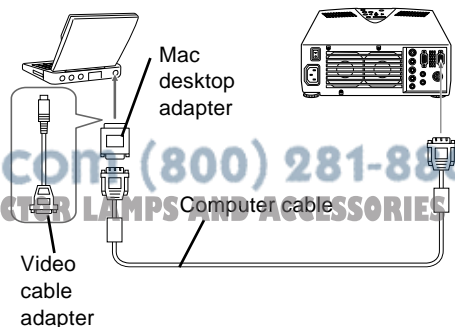

FixYourDLP.com sponsored by DM  
 Discount-Merch.com (800) 281-8850  
 THE TRUSTED SOURCE FOR PROJECTOR LAMPS AND ACCESSORIES

# EPSON®

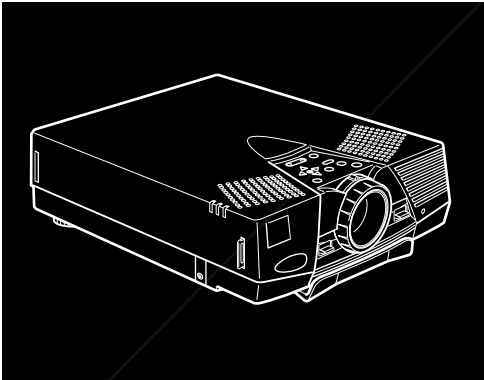

## EMP-7500/5550/5500™

DATA/VIDEO PROJECTOR

FixYourDLP.com  
Sponsored by DM

Discount-Merchant.com (800) 281-8860

THE TRUSTED SOURCE FOR PROJECTOR OWNERS MANUAL

Owner's Manual



All rights reserved. No part of this publication may be reproduced, stored in a retrieval system, or transmitted in any form or by any means, electronic, mechanical, photocopying, recording, or otherwise, without the prior written permission of SEIKO EPSON CORPORATION. No patent liability is assumed with respect to the use of the information contained herein. Neither is any liability assumed for damages resulting from the use of the information contained herein.

Neither SEIKO EPSON CORPORATION nor its affiliates shall be liable to the purchaser of this product or third parties for damages, losses, costs, or expenses incurred by purchaser or third parties as a result of: accident, misuse, or abuse of this product or unauthorized modifications, repairs, or alterations to this product, or (excluding the U.S.) failure to strictly comply with SEIKO EPSON CORPORATION's operating and maintenance instructions.

SEIKO EPSON CORPORATION shall not be liable against any damages or problems arising from the use of any options or any consumable products other than those designated as Original EPSON Products or EPSON Approved Products by SEIKO EPSON CORPORATION.

EPSON is a registered trademark and PowerLite is a trademark of SEIKO EPSON CORPORATION.

**General Notice:** The following trademarks and registered trademarks are the property of their respective owners and are used in this publication for identification purposes only.

- EPSON/Seiko Epson Corp.
- Macintosh, Macintosh OS System 7, PowerBook, Quadra, Centris, Power Mac/Apple Computer Corp.
- IBM/International Business Machines, Inc.
- Windows 3.x, Windows 95/Microsoft Corp.
- SRS and the SRS symbol **SRS** (●)® are registered trademarks of SRS Labs, Inc. in the United States and selected foreign countries. SRS technology is incorporated under license from SRS Labs, Inc. and is protected under United States Patent Nos. 4,748,669 and 4,841,572 with numerous additional issued and pending foreign patents. Purchase of this product does not convey the right to sell recordings made with SRS technology.
- SRS is an abbreviation for SOUND RETRIEVAL SYSTEM.

Other product names used herein are also for identification purposes only and may be trademarks of their respective owners. EPSON disclaims any and all rights in those marks.



# Contents

<b>Contents</b>	<b>iii</b>
<b>Introduction</b>	<b>vii</b>
Getting the Most Out of Your Projector .....	ix
Remote control .....	ix
Optional Accessories .....	x
About This Manual .....	xi
Safety Instructions .....	xii
Where to Get Help .....	xiv
World Wide Web site .....	xv
Transporting your projector .....	xv
<b>1 Installation</b>	<b>1</b>
Unpacking the Projector .....	2
Additional Components .....	3
Setting Up the Projector .....	4
Connecting to a Computer .....	7
Connecting to a PC desktop computer .....	8
Connecting to a PC laptop computer .....	10
Connecting to a Macintosh desktop computer .....	12
Connecting to a Macintosh PowerBook .....	14
Connecting to a Video Source .....	16
Connecting to an External Speaker or PA System .....	18

FixYourPC.com  
 DiscountMerchant.com (800) 281-8160  
 THE TRUSTED SOURCE FOR PROJECTOR LAMP AND ACCESSORIES

<b>2</b>	<b>Using the Projector</b>	<b>21</b>
	Turning the Equipment On and Off .....	23
	Turning the Projector On and Off .....	23
	Sleep Mode .....	24
	Focusing and Positioning the Screen Image .....	25
	Resize Button .....	27
	Controlling the Projector.....	28
	Using the Remote Control .....	29
	Using the Operation Panel .....	31
	Projector Status Indicators .....	33
	Operation Indicator.....	33
	Lamp Indicator.....	34
	Temperature Indicator.....	34
<b>3</b>	<b>Using the Projector Menus</b>	<b>35</b>
	Accessing the Main Menu .....	36
	Changing a Menu Setting .....	36
	Video Menu (Image source = Computer) .....	39
	Video Menu (Image source = Video) .....	41
	Audio Menu .....	42
	Setting Menu .....	42
	User's Logo Menu .....	45
	Effect Menu .....	47
	About Menu.....	48
	RESET ALL Menu.....	48
<b>4</b>	<b>Maintenance</b>	<b>51</b>
	Cleaning the Lens.....	52
	Cleaning the Projector Case.....	52
	Cleaning the Air Filter .....	53
	Replacing the Lamp.....	54
<b>5</b>	<b>Troubleshooting</b>	<b>57</b>
	Problems with the Projector.....	58
	Problems with the Image or Sound.....	60

**Discount-Merchant.com (800) 281-8860**  
 THE TRUSTED SOURCE FOR PROJECTOR LAMPS AND ACCESSORIES

---

<b>6 Technical Specifications</b>	<b>63</b>
Supported Monitor Displays (EMP-7500) .....	65
Supported Monitor Displays (EMP-5550/5500) .....	66
Monitor and Computer connector pin assignments .....	67
<b>Glossary</b>	<b>69</b>
<b>Index</b>	<b>71</b>



**Discount-Merchant.com (800) 281-8860**  
**THE TRUSTED SOURCE FOR PROJECTOR LAMPS AND ACCESSORIES**



**Discount-Merchant.com (800) 281-8860**  
**THE TRUSTED SOURCE FOR PROJECTOR LAMPS AND ACCESSORIES**

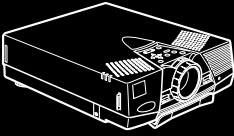

# Introduction

Your EPSON EMP series projector is a compact, lightweight projector that lets you project XGA(EMP-7500) or SVGA(EMP-5550/5500) full-color images and video onto a large screen for presentations. The projector can connect simultaneously to two image sources: one PC or Apple® Macintosh® computer image sources plus one video source such as a video tape deck, camcorder, or digital camera. Audio can also be connected for each image source.

Images are displayed in true XGA and SVGA full color (16,670,000 colors) at a resolution of 1024 × 768(EMP-7500) and 800 × 600(EMP-5550/5500) pixels. Your projector produces bright images that can be easily seen in rooms light enough to take notes. Audio can be produced from the projector's 1W+1W stereo, which employ a built-in SRS 3D sound® for output that is rich and powerful. You can also connect an external speaker when further amplification is required.

A totally new AVTSS™ (Automatic Video Tracking and Synchronization Sensing, patent pending) provides automatic set-up of image from a computer for quick and easy projection of beautiful images every time.

You can control your projector through a hand-held remote control unit, with menus being provided for image source switching and image adjustment. The remote control can also act as a wireless mouse to control mouse operations on your



Discount-Merchandise.com 1-800-281-8860  
THE TRUSTED SOURCE FOR PROJECTOR BULBS AND ACCESSORIES



---

computer screen during presentations. The optional ELP LINK III™ provides a number of add-on features that are designed to make presentations more effective.

Your projector also features a new patented BIS CUIT (Balanced Image Size Conversion UnIT) chip which supports XGA(EMP-7500), VGA~XGA(EMP-5550/5500) computer output, as well as VGA and SXGA output. No matter what type of computer output is used, the result is a full-size video image of outstanding clarity.

Your projector supports IBM-compatible PCs and laptops, as well as Apple® Macintosh®, Power Macintosh and PowerBook computers. The video source can be NTSC, PAL or SECAM in composite video, S-Video format.



**Discount-Merchant.com (800) 281-8860**  
**THE TRUSTED SOURCE FOR PROJECTOR LAMPS AND ACCESSORIES**

---

# Getting the Most Out of Your Projector

Your projector comes with a full set of features that enable you to control the settings for the image display, video and audio. To get the most out of your projector, read this section for a quick summary of the important features.

## Remote control

The buttons on the remote control let you turn the projector on or off, and provide direct access to auto set-up, blank, freeze, volume, mute and image source switching. Use the remote control buttons to access custom functions and the projector's menu system. You can even use the remote control in place of your computer's mouse.



**Discount-Merchant.com (800) 281-8860**  
**THE TRUSTED SOURCE FOR PROJECTOR LAMPS AND ACCESSORIES**



---

## Optional Accessories

To enhance your use of the projector, EPSON provides the following optional accessories:

- Spare lamp (EMP-7500/5500) ELPLP06
- Spare lamp (EMP-5550) ELPLP07
- Computer cable ELPKC02
- Link set for PC ELPSW03
- Link set for Mac ELPSW04
- Link set for 98 ELPSW05
- Image Presentation Camera ELPDC01
- Mac Adapter Set ELPAP01
- Ceiling Mount ELPMB03
- Ceiling Plate ELPFC01
- Pipe 370 ELPFP01
- Pipe 570 ELPFP02
- Pipe 770 ELPEP03
- Hard Travel Case ELPKS11
- Portable Screen ELPSC06
- PC Selector ELPST01



**Discount-Merchant.com (800) 281-8860**  
**THE TRUSTED SOURCE FOR PROJECTOR LAMPS AND ACCESSORIES**

---

# About This Manual

Chapter 1, “Installation”, gives step-by-step instructions on how to set up the projector and connect it to your computer, video source, or other external speaker or PA system. Read the installation procedures that apply to your configuration.

Chapter 2, “Using the Projector”, describes how to switch the projector on/off and control simple projector settings using the remote control or operation panel.

Chapter 3, “Using the Projector Menus”, describes how to use the menus to adjust the color and image settings, change the display of the projected image and modify audio settings such as bass and treble.

Chapter 4, “Maintenance”, describes how to clean your projector and perform limited maintenance.

Chapter 5, “Troubleshooting”, describes you how to interpret the projector’s indicator lights and gives helpful information for avoiding errors, optimizing image quality and solving problems.

Chapter 6, “Technical Specifications,” lists the technical specifications for your projector.

A Glossary and Index are provided at the end of the manual.



**Discount-Merchant.com (800) 281-8860**  
**THE TRUSTED SOURCE FOR PROJECTOR LAMPS AND ACCESSORIES**

---

# Safety Instructions

Follow these safety instructions when setting up and using the projector:

1. Do not place the projector on an unstable cart, stand, or table.
2. Do not use the projector near water or sources of heat.
3. Use attachments only as recommended.
4. Use the type of power source indicated on the projector. If you are not sure of the power available, consult your dealer or local electricity company.
5. Place the projector near a wall outlet where the plug can be easily unplugged.
6. Insert the projector's three-pin grounding-type plug into a properly grounded outlet. If you have a two-prong outlet, contact an electrician to replace it. Do not handle the plug with wet hands.
7. Take the following precautions when handling the plug. Failure to comply with these precautions may result in sparks or fire.
  - Do not insert the plug into an outlet with dust present.
  - Insert the plug firmly into the outlet.
8. Do not overload wall outlets, extension cords or integral convenience receptacles. This may cause fire or electric shock.
9. Do not place the projector where the cord can be stepped on. It may result in fraying or damage to the plug.
10. Unplug the projector from the wall outlet before cleaning. Use a damp cloth for cleaning. Do not use liquid or aerosol cleaners.



FixYourDLP.com

Sponsored by 

Discount-Merchant.com (800) 281-8860

THE TRUSTED SOURCE FOR PROJECTOR LAMPS AND ACCESSORIES

- 
11. Do not block the slots and openings in the projector case. They provide ventilation and prevent the projector from overheating. Do not place the projector on a sofa, rug or other soft surface, or in a closed-in cabinet unless proper ventilation is provided.
  12. Never push objects of any kind through cabinet slots. Never spill liquid of any kind into the projector.
  13. Except as specifically explained in this User's Guide, do not attempt to service this product yourself. Refer all servicing to qualified service personnel. Opening or removing covers may expose you to dangerous voltages and other hazards.
  14. Unplug the projector during thunder storms or when it will not be used for extended periods.
  15. Do not place the projector and remote control on top of heat-producing equipment or in a heated place, such as a car.
  16. Unplug the projector from the wall outlet and refer servicing to qualified service personnel under the following conditions;
    - When the power cord or plug is damaged or frayed
    - If liquid has been spilled into the projector or it has been exposed to rain or water
    - If it does not operate normally when you follow the operating instructions, or if it exhibits a distinct change in performance, indicating a need for servicing.
    - If it has been dropped or the housing has been damaged.



**Discount-Merchant.com (800) 281-8860**  
**THE TRUSTED SOURCE FOR PROJECTOR LAMPS AND ACCESSORIES**

---

# Where to Get Help

If you are having trouble setting up or running your projector, first see Chapter 5, "Troubleshooting". If you cannot resolve the problem, contact the appropriate representative listed in the section entitled "After sales service contact addresses" at the end of this manual.

Before you call, please have the following information ready:

- Product name
- Product serial number
- Computer configuration
- Description of the problem



**Discount-Merchant.com (800) 281-8860**  
**THE TRUSTED SOURCE FOR PROJECTOR LAMPS AND ACCESSORIES**

---

## World Wide Web site

If you connect to the Internet and have a Web browser, you can access to EPSON's World Wide Web site at <http://www.epson.com>. EPSON's home page provides you What's New, EPSON Products, EPSON Connection, Corporate Info and EPSON Contacts. Link to the EPSON Connection for the latest drivers and FAQ's (Frequently Asked Questions) and the EPSON Chart area. To get in touch with EPSON around the world, EPSON Contacts includes Contact Information for local EPSON subsidiaries.

## Transporting your projector

Your projector contains many glass parts and precision parts. To prevent shock damages while transporting, handle as the following.

When transporting to maker due to troubleshooting

- Use the original packing.
- If you don't have the original packaging use the equivalent. Put cushioning around the projector.

When frequently transporting for business use

- First, put the projector in a hard travel case (optional accessories : ELPKS11), then pack it in a firm box, using cushioning. Be sure to ask the delivery company which creates a precision device.



**Discount-Merchant.com (800) 281-8860**  
**THE TRUSTED SOURCE FOR PROJECTOR LAMPS AND ACCESSORIES**

---

When carrying by hands

- Use a hard travel case (optional accessories : ELPKS11) or a soft travel case (additional components).

When traveling by an airplane

- Be sure to bring the projector with you when traveling by an airplane.
- When transporting the projector as baggage on an airplane, first put the projector in a hard travel case to avoid any damage.

EPSON shall not be liable against any damages arose during the transportation.



**Discount-Merchant.com (800) 281-8860**  
**THE TRUSTED SOURCE FOR PROJECTOR LAMPS AND ACCESSORIES**



1

## Installation

This chapter describes how to unpack and set up your projector, and connect it to other equipment. The projector must be connected to a computer or a video source such as a video tape deck, camcorder, digital camera or laser disk player before it can project any images.

You may also want to set up the projector for one or more of the following:

- Connect the mouse cable to use the remote control as a wireless mouse.
- Connect the projector to an audio source for one or both image sources. The audio source can be the computer, video source, or another device such as a stereo.
- Connect the projector to an external speaker or PA system to amplify the audio.



**Discount-Merchant.com (800) 281-8860**  
THE TRUSTED SOURCE FOR PROJECTOR LAMPS AND ACCESSORIES



---

# Unpacking the Projector

When you unpack the projector, make sure you have all these components:

- Projector
- Remote Control
- 2 AA batteries
- Power cord
- Computer cable
- Audio cable
- A/V cable
- Mouse cable (for PS/2 and Mac)
- Owner's manual
- Hand strap
- Soft carrying case

Depending on the configuration of your equipment, you may not need all these components.

Save all packing in case you need to ship the projector in the future. It should always be transported in its original packages or the equivalent.



**Discount-Merchant.com (800) 281-8860**  
**THE TRUSTED SOURCE FOR PROJECTOR LAMPS AND ACCESSORIES**

---

## Additional Components

Depending on how you plan to use the projector, you may need these additional components:

- To receive an S-Video signal, you need an S-Video cable. (One is usually provided with your video device.) A separate cable is required for each video source.
- To connect the projector to a Macintosh PowerBook, you need a video-out cable. (One is provided by/or can be purchased from Apple for all new PowerBooks that have video-out capability.) If your PowerBook does not include one, see your Macintosh dealer.
- To connect the mouse cable to your computer, you may require a special connector, cable, or other components. You can obtain these items from your computer dealer. If your computer doesn't have a mouse connector, you cannot use the mouse cable.

◆ **Note:** *You can connect a Kensington MicroSaver® anti-theft device in the hole on the projector's right side. Contact your computer dealer.*



**Discount-Merchant.com (800) 281-8860**  
**THE TRUSTED SOURCE FOR PROJECTOR LAMPS AND ACCESSORIES**

# Setting Up the Projector

1. Place the projector on a sturdy, level surface within five feet of the computer or video source.

◆ **Caution:** *Do not hold the projector by the lens. This can damage the lens.*

2. Place the projector at a correct distance from the screen.

The distance between the projector and the screen determines the actual image size. Use the general guidelines below to determine the correct distance.

Screen size	Horizontal distance from projector to screen
300 inches (610x460cm)	493.7 inches (12.6 m) ~ 638.7 inches (16.3 m)
200 inches (410x300cm)	315.0 inches (8.0 m) ~ 409.4 inches (10.4 m)
100 inches (200x150cm)	157.5 inches (4.0 m) ~ 204.7 inches (5.2 m)
80 inches (160x120cm)	126.0 inches (3.2 m) ~ 165.4 inches (4.2 m)
60 inches (120x90cm)	94.5 inches (2.4 m) ~ 122.0 inches (3.1 m)
40 inches (81x61cm)	63.0 inches (1.6 m) ~ 82.7 inches (2.1 m)
30 inches (61x46cm)	47.2 inches (1.2 m) ~ 63.0 inches (1.6 m)
25 inches (51x38cm)	39.4 inches (1.0 m) ~ 51.2 inches (1.3 m)
19 inches (39x29cm)	39.4 inches (1.0 m)



**Discount-Merchant.com (800) 281-8860**  
THE TRUSTED SOURCE FOR PROJECTOR LAMPS AND ACCESSORIES

- 
3. Turn the projector so that the lens is at right angles to the screen. If the projector is not angled correctly, the screen image will be crooked.
  4. Connect one end of the power cable to the projector's power connector. Connect the other end to an earthed electrical socket.  
The projector should be in sleep mode, indicated by an orange power indicator.

- ◆ **Warning:** *Never look into the lens when the projector is on. There is a risk that the projector might come on suddenly even though it is not in use. The light from the lamp can damage your eyes. It is especially important that children should not be allowed to look into the lens.*



**Discount-Merchant.com (800) 281-8860**  
**THE TRUSTED SOURCE FOR PROJECTOR LAMPS AND ACCESSORIES**

5. To insert the batteries in the remote control device, slide off the battery compartment cover as shown below.

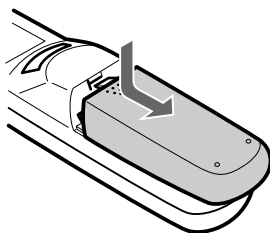

6. Insert the two AA batteries included with the projector. Make sure the polarity of the batteries is correct.

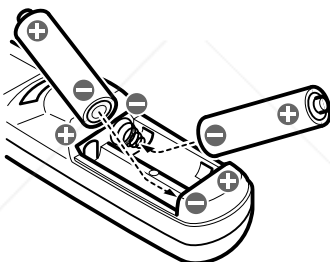

7. Replace the battery compartment cover.

When replacing batteries, take the following precautions:

- Do not recharge the used batteries or expose to fire or water.
- Replace batteries as soon as they run out. If the batteries leak, wipe away battery fluid with a soft cloth. If fluid gets on your hands, wash them immediately.

- Remove the batteries if you will not be using the projector for a long period of time.

---

# Connecting to a Computer

You can connect the projector to a computer capable of XGA, VGA, and SVGA output. Resizing is supported for VGA, XGA output. The following types of computers are supported:

- IBM desktop PC or compatible
- IBM laptop or compatible
- Apple Macintosh desktop computer, including Macintosh Quadra®, Macintosh Centris®, and Power Macintosh
- Any Apple PowerBook with video-out capability, including all 160, 165, 180 and 500 series PowerBooks

To connect the video and mouse cable ( to use the wireless remote as a mouse pointer), see the section in this chapter that applies to your computer.



**Discount-Merchant.com (800) 281-8860**  
**THE TRUSTED SOURCE FOR PROJECTOR LAMPS AND ACCESSORIES**

# Connecting to a PC desktop computer

Before beginning, turn off the projector and computer if they are on.

1. Connect the computer cable.

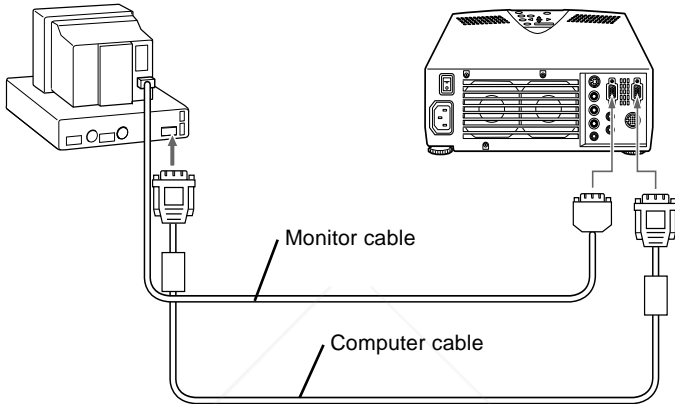

◆ **Note:** *Computer configurations vary. See your computer manual for the location of the ports needed to connect your projector.*

- a. Connect either end of the computer cable to the projector's Computer In port.
- b. Disconnect the monitor cable from the computer, and connect the other end of the computer cable to the terminal where the monitor cable is disconnected from the computer.
- c. If necessary, connect the monitor cable of the computer monitor to the projector's Computer Out port.
- d. Tighten the screws on all connectors.

---

2. Connect the audio cable if needed.

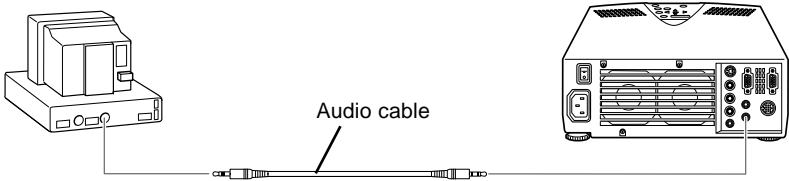

- a. Connect one end of the audio cable to the Audio In jack on the projector.
- b. Connect the other end of the audio cable to the audio out port on a sound card in the computer.



**Discount-Merchant.com (800) 281-8860**  
**THE TRUSTED SOURCE FOR PROJECTOR LAMPS AND ACCESSORIES**



# Connecting to a PC laptop computer

Before beginning, turn off the projector and computer if they are on.

1. Connect the computer cable.

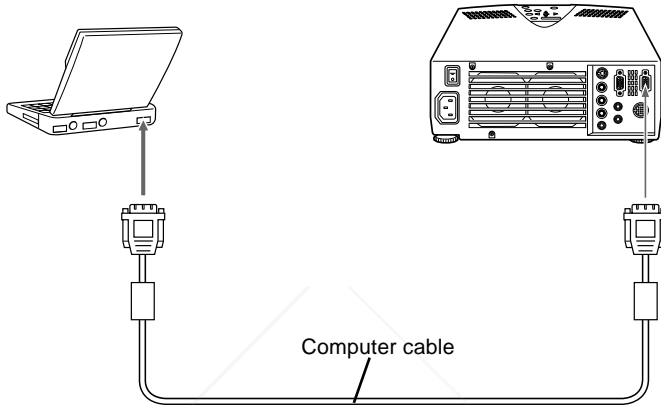

- ◆ **Note:** *Laptop configurations vary. See your computer manual for the location of the ports needed to connect your projector.*
  - a. Connect either end of the computer cable to the projector's Computer In port.
  - b. Connect the other end of the computer cable to the laptop's video (monitor) port.
  - c. Tighten the screws on all connectors to make sure they are fastened securely.



**Discount-Merchant.com (800) 281-8860**  
THE TRUSTED SOURCE FOR PROJECTOR LAMPS AND ACCESSORIES

---

2. Connect the audio cable.

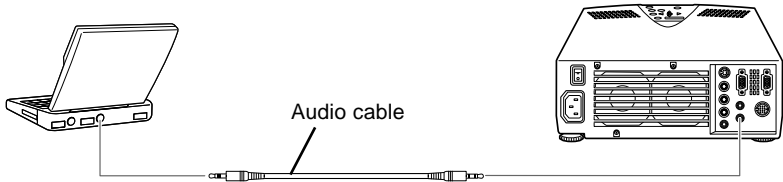

- a. Connect one end of the audio cable to the Audio In jack on the projector.
- b. Connect the other end of the audio cable to your laptop.



**Discount-Merchant.com (800) 281-8860**  
**THE TRUSTED SOURCE FOR PROJECTOR LAMPS AND ACCESSORIES**

# Connecting to a Macintosh desktop computer

Before beginning, turn off the projector and computer if they are on.

1. Connect the computer cables.

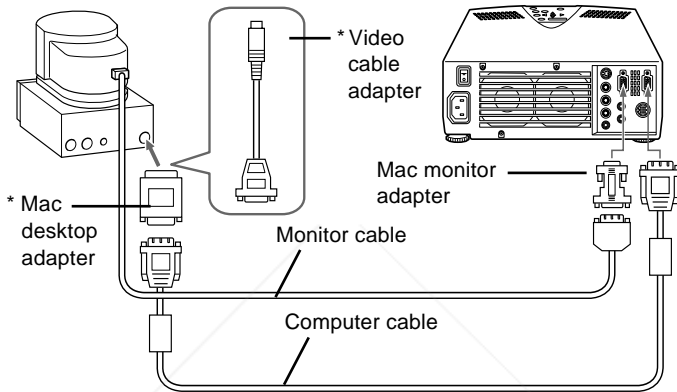

◆ **Note:** *Macintosh computer configurations vary. See your computer manual for the location of the ports needed to connect your projector.*

\* *You may need adapters that came with your computer or purchased from your computer dealer for connecting.*

- a. Connect either end of the computer cable to the projector's Computer In port.
- b. Connect the other end of the computer cable to the monitor or video port where monitor cable is disconnected from the computer.
- c. If necessary, connect the monitor cable to the projector's Computer out.

---

2. Connect the audio cable.

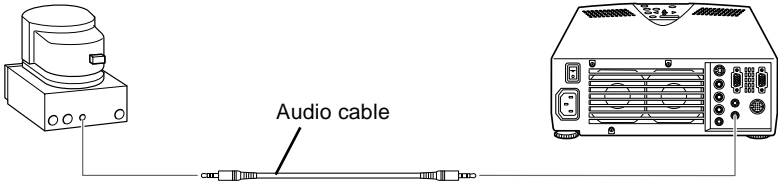

- a. Connect one end of the audio cable to the Audio In jack on the projector.
- b. Connect the other end of the audio cable to your computer.



**Discount-Merchant.com (800) 281-8860**  
**THE TRUSTED SOURCE FOR PROJECTOR LAMPS AND ACCESSORIES**

# Connecting to a Macintosh PowerBook

Remember that you can only use a PowerBook model that has video-out capability. See page 7 for more information.

Before beginning, turn off the projector and computer if they are on.

1. Connect the computer cable.

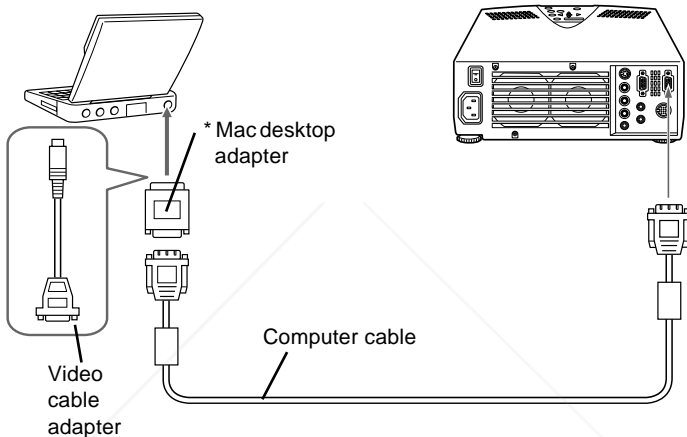

◆ **Note:** *PowerBook configurations vary. See your computer manual for the location of the ports needed to connect your projector.*

\* *You may need adapters that came with your computer or purchased from your computer dealer for connecting.*

- a. Connect the other end of the computer cable to the projector's Computer In port.
- b. Connect the other end of the computer cable to the video port (monitor output port) of your PowerBook.
- c. Tighten the fixed screws on all connectors.

---

2. Connect the audio cable.

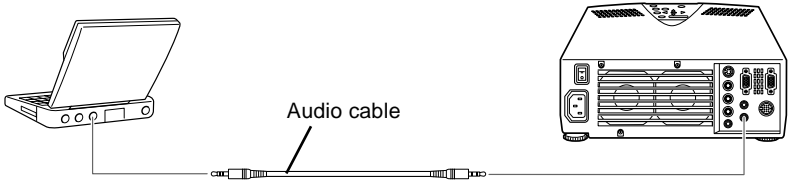

- a. Connect one end of the audio cable to the Audio In jack on the projector.
- b. Connect the other end of the audio cable to your computer.



**Discount-Merchant.com (800) 281-8860**  
**THE TRUSTED SOURCE FOR PROJECTOR LAMPS AND ACCESSORIES**

---

## Connecting to a Video Source

You can connect a video tape deck, camcorder, laser disc player or any other compatible video image source to your projector.

The projector can receive composite video or S-Video. If your video source has a one-pin RCA video jack, your equipment has composite video. If your video source has a four-pin video jack, your equipment has S-Video. If your video source has a three-pin video jack, your equipment has G Sync-Video.

- ◆ **Note:** *The projector is not compatible with a cable TV-style F connector.*

You can connect the projector to both an S-Video and a composite video source at the same time. However, the projector automatically selects the S-Video as the video source. To display composite video, first disconnect the S-Video source.

The projector supports NTSC, PAL, PAL 60 and SECAM video formats, and automatically detects and identifies the video format. However, you can specify that a single broadcast format being detected. (See “Video menu” in Chapter 3.)

Note that the projector will then be able to detect only one type of video format.

The type of cable you use to connect the video source to the projector depends on whether you have composite video, S-Video or G Sync-Video. For composite video, use the audio/video (A/V) cable supplied with the projector.

For S-Video, use the S-Video cable and the audio cable supplied with your video device or obtain one from your computer dealer. For G Sync-Video, use the BNC type cable came with your video source.

To connect a video source to the projector:

1. Turn off the projector and video source if they are on.
2. If your composite video uses an RCA-type composite video connector, you will need the A/V cable supplied with your projector. If your video uses a S-Video, you will need to provide YOUR OWN S-Video or use the S-Video cable that came with your video source.
3. For composite video, connect the yellow RCA plug at one end of the A/V cable to the projector's Video jack. Connect the other yellow RCA plug to the video-out jack on the video source.

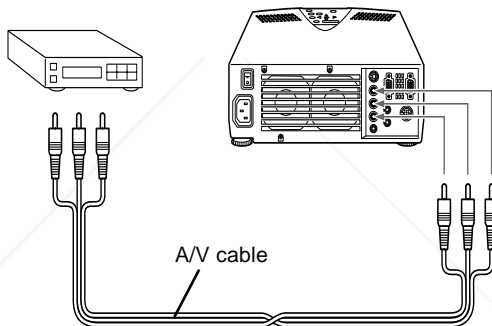

4. Connect the other plugs on the A/V cable to the Audio jacks of the projector: insert the white plug into the L jack and the red plug into the R jack. Connect the plug at the other end of the A/V cable to the audio output jacks of the video source.



5. For S-Video, insert one end of the S-Video cable into the projector's S-Video jack. Insert the other end in the S-Video Out jack on your S-Video source.

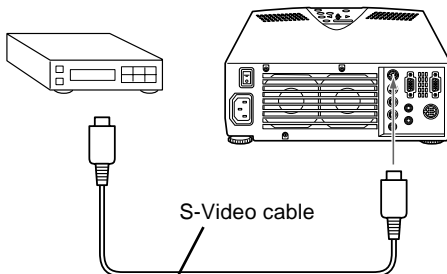

## Connecting to an External Speaker or PA System

Although the projector's internal speakers are enough for most small-size or medium-size rooms, an external speaker for large room to gain maximum benefit from the projector's built-in SRS 3D sound function.

To connect the projector to an external sound system, you need to obtain an RCA-to-3.5 mm stereo mini audio cable or 3.5 mm stereo mini audio cable from your computer dealer.

1. Before beginning, turn off the projector and all sources if they are on.



**Discount-Merchant.com (800) 281-8860**  
THE TRUSTED SOURCE FOR PROJECTOR LAMPS AND ACCESSORIES

2. Connect the cable's 3.5 mm stereo mini plug to the projector's Audio Out jack.

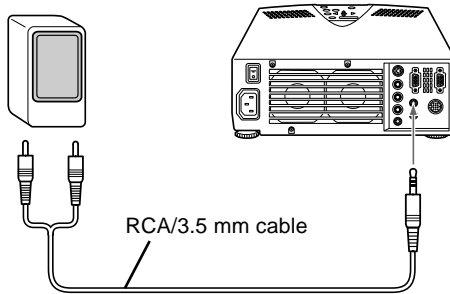

3. Connect the other end of the cable to the external speaker or PA system. Insert the cable's red RCA plug into the right channel, and the white RCA plug into the left channel.



**Discount-Merchant.com (800) 281-8860**  
THE TRUSTED SOURCE FOR PROJECTOR LAMPS AND ACCESSORIES



**Discount-Merchant.com (800) 281-8860**  
**THE TRUSTED SOURCE FOR PROJECTOR LAMP AND ACCESSORIES**



# 2

## Using the Projector

This chapter provides the following information about using your projector:

- Turning the equipment on and off
- Focusing and positioning the screen image
- Controlling the projector with the remote control and the operation panel
- Monitoring the projector's operating status



**Discount-Merchant.com (800) 281-8860**  
THE TRUSTED SOURCE FOR PROJECTOR LAMPS AND ACCESSORIES

The illustration below identifies the parts of your projector.

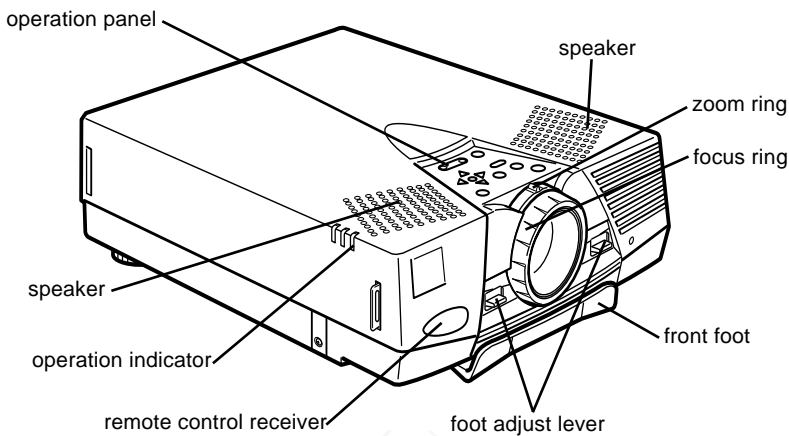

**Discount-Merchant.com (800) 281-8860**  
THE TRUSTED SOURCE FOR PROJECTOR LAMPS AND ACCESSORIES

---

# Turning the Equipment On and Off

Turn on the projector and its attached equipment in the following order.

1. Video source
2. Audio source (if different from computer or video source)
3. Projector
4. External speaker or PA system
5. Computer

When you turn off the equipment, do so in the reverse order.

## Turning the Projector On and Off

1. Remove the projector lens cap.
2. Press the Power button on the remote control or operation panel. The power indicator flashes as the projector warms up. When the projector is fully warmed up, this light remains green.

If computer or video equipment is attached, the computer or video signal is projected.

Allow about 30 seconds for full illumination.

- ◆ **Warning:** *Never look into the lens when the lamp is on. This can damage your eyes. It is especially important that children are not allowed to look into the lens.*

◆ **Caution:** *When turning the projector on or off with the remote control, be sure to turn the remote control on first with the power switch.*

 FixYourDLP.com  
Sponsor  
**DiscountMerchant.com (800) 281-8860**  
THE TRUSTED SOURCE FOR PROJECTOR LAMPS AND ACCESSORIES

After you press the Power button to turn off the projector, the fan will remain on and the operation indicator will flash orange for about one minute as the projector cools down.

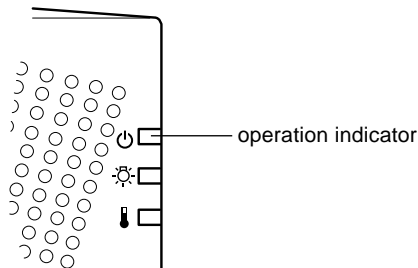

When the projector has cooled down, the operation indicator stops flashing and remains orange.

- ◆ **Note:** *If you press the Power button to turn the projector back on while the operation indicator is orange, there may be a delay before a projected image appears.*
- ◆ **Note:** *Do not project the same static image for extended time. Doing so may print the image and cause the afterimage on the panel.*

## Sleep Mode

Sleep mode conserves electricity by automatically turning off the lamp after the projector has not been used for 30 minutes. In sleep mode, the projector's operation indicator is orange and only a minimum amount of the projector's circuitry remains on. This conserves electricity, cools the projector, and extends the life of the lamp. When the projector is in sleep mode, you can press the Power button to resume projecting images, or you can unplug the projector's power cord to turn it off.

- ◆ **Note:** *When you don't use the projector, turn off the power switch on the projector. The orange operation indicator turns off.*

---

# Focusing and Positioning the Screen Image

When an image appears on the screen, check that it is in focus and correctly positioned on the screen.

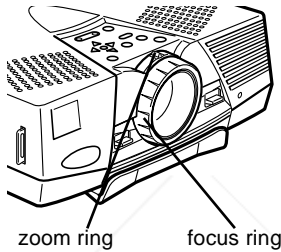

- To focus the image, rotate the focus ring (the outer ring on the projector's lens).
- To adjust the size of the image, rotate the inner zoom ring. Rotate the zoom ring wide to make the image larger, or tele to make it smaller.



**Discount-Merchant.com (800) 281-8860**  
THE TRUSTED SOURCE FOR PROJECTOR LAMPS AND ACCESSORIES



---

If you need to raise or lower the image on the screen, extend or retract the two feet at the bottom of the projector as follows:

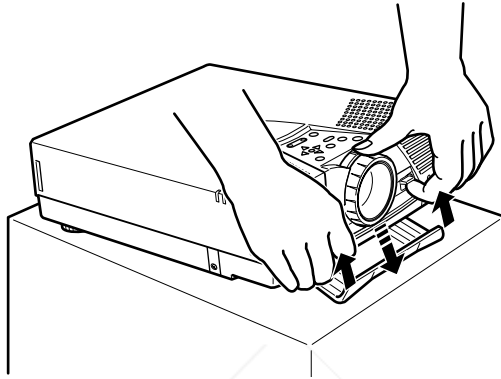

1. Stand behind the projector and support the front of it while you lift the foot adjust lever above the feet. This unlocks the feet so they can move up and down freely. Do not let the projector drop.

◆ **Caution:** *Do not hold the projector by its lens. This can damage the lens.*

2. While lifting the foot adjust lever, raise or lower the projector until the screen image is positioned correctly.
3. Release the lever to lock the feet in their new position.
4. To fine-tune the height of the projector, turn the rear feet clockwise to raise the height or anti-clockwise to lower it.



**Discount-Merchant.com (800) 281-8860**  
**THE TRUSTED SOURCE FOR PROJECTOR LAMPS AND ACCESSORIES**

---

## Resize Button

The Resize button lets you switch between Resize display and Window display.

The Resize button cannot be used with XGA(1024 × 768 pixels) for EMP-7500 and SVGA(800 × 600 pixels) for EMP-5550/5500.

### How to switch

With images up to XGA(1024 × 768 pixels) size (for example a 600 × 480 pixels VGA image), press the Resize button alternately. The Resize display changes the VGA(600 × 480) image into the SVGA(800 × 600) image. The Window display projects the VGA(600 × 480) image as it is. The projected image gets smaller than SVGA(800 × 600) image.

With images SVGA(800 × 600 pixels) size, the image is displayed with the maximum size in both Resize and Window display. Pressing the Resize button does not make any change.

With images larger than SVGA(800 × 600 pixels) size (for example a 1024 × 768 pixels XGA image), you can either select to display a portion of the projected image (Window display) or the entire projected image (Resize display).

Each time you press the Resize button, the projected image is displayed in the following order:

1. The XGA image is reduced to the SVGA size.
2. The projected image is displayed with XGA size, and only the upper of the right image is projected on the screen.
3. The upper of the left image is projected on the screen.
4. The bottom of the right image is projected on the screen.
5. The bottom of the left image is projected on the screen.
6. The center of the image is projected on the screen.

After the step 6, press the Resize button again to return to the step 1.



FixYourDLP.com

Sponsored by

Discount-Merchant.com (800) 281-8860

THE TRUSTED SOURCE FOR PROJECTOR LAMPS AND ACCESSORIES

---

# Controlling the Projector

You can use the operation panel on top of the projector or the remote control to perform the following actions:

- Turn power on and off
- Switch between input sources (video - computer)
- Access the projector menus to adjust the image, audio, video, and display settings
- Control resizing
- Control display freeze
- Control A/V mute (Cuts off the image and sound temporarily.)
- Adjust or mute audio output
- Use custom functions (remote control only)
- Use effect functions (for enhancing projected images on the screen; remote control only)



**Discount-Merchant.com (800) 281-8860**  
**THE TRUSTED SOURCE FOR PROJECTOR LAMPS AND ACCESSORIES**

# Using the Remote Control

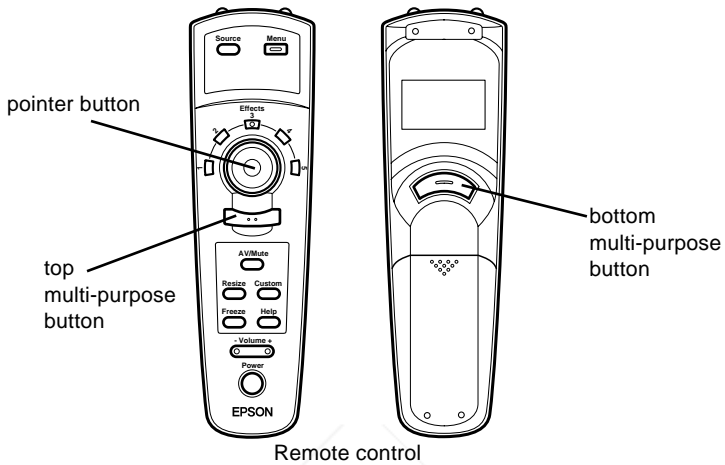

To use the remote control, point it towards the remote control receivers located at the front and back of the projector.

To be able to use the remote control as a cordless mouse, connect the mouse cable (for PS/2) to the projector and your computer.

You can use the remote control up to 10 metres (33 feet) from the projector.

- ◆ **Note:** *The projector may not respond to remote control commands in these conditions: ambient light is too bright; a certain type of fluorescent light is present; a strong light source (such as direct sunlight) shines into the infrared receiver; or other equipment emitting infrared energy is present (such as a radiant room heater). Correct these conditions to use the remote control or control the projector from a computer.*

- ◆ **Note:** *If you use the other mouse except the PS/2 mouse, you need to purchase the Link Set to connect.*

FixYourDLP.com  
Sponsored by  
DiscountMerchants.com (800) 281-8860  
THE TRUSTED SOURCE FOR PROJECTOR LAMPS AND ACCESSORIES

In addition to the remote control, you can also control the projector by using the buttons on the projector's operation panel located on top of the projector.

This table summarizes the functions on the remote control.

<b>Button</b>	<b>Function</b>
Menu	Displays or hides the menu.
Source	Switches the input source to Concomputer or Video.
Effects buttons	Use to display special effects; 1 Pointer, 2 Box, 3 Line, 4 Marker, 5 Clear.
Top multi-purpose button	Acts as a right mouse click, registers a menu selection, and selects other custom functions.
Bottom multi-purpose button	Acts as a left mouse click, registers a menu selection, and selects other custom functions.
Help	Displays the help menu for various types of problems you may encounter.
Resize	Switches between Resizing screen and Window screen (PC input).
Custom	Zooms an image using the Mouse Right/Left buttons.
Freeze	Keeps the current computer or video image on the screen.
AV/Mute	Turns off the image and sound of the projector temporarily.
- Volume +	Adjusts the volume.
Power	Turns the projector on or off.



**Discount-Merchant.com (800) 281-8860**  
**THE TRUSTED SOURCE FOR PROJECTOR LAMPS AND ACCESSORIES**

# Using the Operation Panel

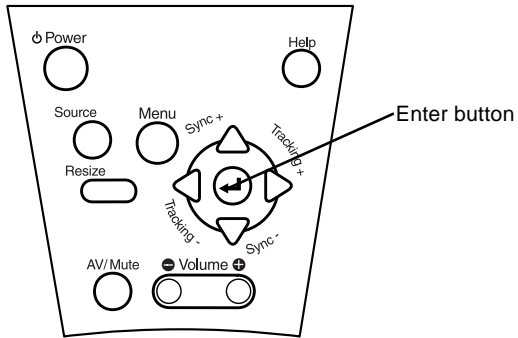

Operation Panel

You can use the operation panel to control the projector instead of the remote control. However, you can program and access the custom features only using the remote control.



**Discount-Merchant.com (800) 281-8860**  
THE TRUSTED SOURCE FOR PROJECTOR LAMPS AND ACCESSORIES

---

The following table summarizes the functions on the operation panel.

<b>Button</b>	<b>Function</b>
Power	Turns the projector on or off.
Source	Switches the input source to Computer or Video.
Menu	Displays or hides the menu.
Up, down arrows (Sync+/Sync-)	Synchronizes the computer's graphic signal. Use these buttons to adjust an overall image that is fuzzy or streaked, or to select menu items during menu operations.
Left, right arrows(tracking-/ tracking+)	Matches the projector's internal clock to various computer graphic signals (tracking adjustment). Use these buttons to adjust an image with vertical lines, or to change numeric settings during menu operations.
Enter key	Registers a menu selection.
Resize	Switches between Resizing screen and Window screen (PC input).
AV/Mute	Turns off the screen and sound of the projector temporarily.
- Volume +	Adjusts the volume.
Help	Displays the help menu for various types of problems you may encounter.

---



**Discount-Merchant.com (800) 281-8860**  
**THE TRUSTED SOURCE FOR PROJECTOR LAMPS AND ACCESSORIES**

# Projector Status Indicators

The power and lamp indicators at the top of the projector tell you its operating status.

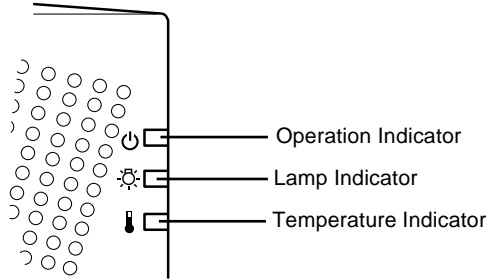

- ◆ **Caution:** A red indicator warns you if a serious problem occurs. See Chapter 5, “Troubleshooting,” for what to do if a warning light comes on.

## Operation Indicator

Displays machine condition.

Color	Status	Meaning
Orange	Lit	Sleep mode.
Green	Flashing	The projector is warming up. Allow about 30 seconds.
Green	Lit (every 1 sec)	Power and the projection lamp are on.
	Lit (every 2 sec)	The computer is in the suspended mode. When the suspended mode is released, the projector starts projecting.
Orange	Flashing	Projection lamp is off, and the projector is cooling down for 2 minute. During the cooling, any operations can not be executed.
Red	Flashing	There is an internal projector problem, or the power to the projector has been cut off.



---

## Lamp Indicator

Displays lamp condition.

This indicator is off when the projector is in a normal condition.

Color	Status	Meaning
-	Off	Lamp is functioning normally.
Orange	Flashing	The lamp needs to be replaced.
Red	Lit	Projection lamp has reached the end of its life and will not longer project images. Replace the projection lamp with a new one.
Red	Flashing	There is a problem with the projection lamp, lamp power supply, lamp fuse, or a circuit malfunctioned in the projector.

## Temperature Indicator

Displays the internal temperature condition.

This indicator is off when the projector is in a normal condition.

Color	Status	Meaning
-	Off	The projector is functioning normally.
Orange	Flashing	The projector is too hot.
Red	Lit	The projector has turned off automatically because of overheating.
Red	Flashing	There is problem with the cooling fan or temperature sensor. Call service representative.



Discount-Merchant.com (800) 281-8860

THE TRUSTED SOURCE FOR PROJECTOR LAMPS AND ACCESSORIES



# 3

## Using the Projector Menu

The seven projector menus enable you to control your projector.

- The Computer menu controls the computer image, such as brightness and contrast, when the image source is computer.
- The Video menu controls the video image, such as brightness and color saturation, when the image source is video, such as a VCR.
- The Audio menu controls audio features, such as the volume level, tone setting, and **SRS**  sound.
- The Setting menu enables you to set various projector options.
- The User's logo menu allows you to select special features such as zoom, backcolor or logo.
- The Effect menu allows you to use effect buttons.
- The About menu provides information about lamp hours, frequency and etc..
- The Reset All menu returns all settings to their factory defaults.



**Discount-Merchant.com (800) 281-8860**  
THE TRUSTED SOURCE FOR PROJECTOR LAMPS AND ACCESSORIES

---

# Accessing the Main Menu

To display the Main menu, press the Menu button on the operation panel or remote control. The Main menu appears:



Press the Menu button again to hide the menu.

# Changing a Menu Setting

To change a menu setting:

1. Press the Menu button on the operation panel or remote control to display the Main menu.

2. Press the up or down buttons (operation panel) or press the top or bottom of the pointer button (remote) to scroll through the menu choices.

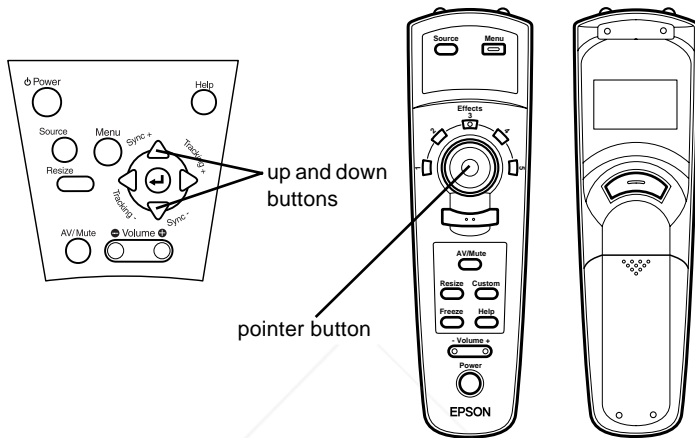

- Press either the Enter button (operation panel) or the top or bottom multi-purpose button (remote) to display a submenu.

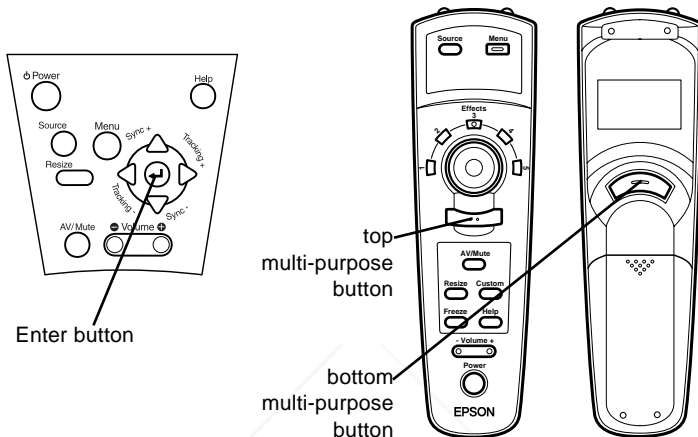

As you select a menu, a sub-menu of options appears to the right.

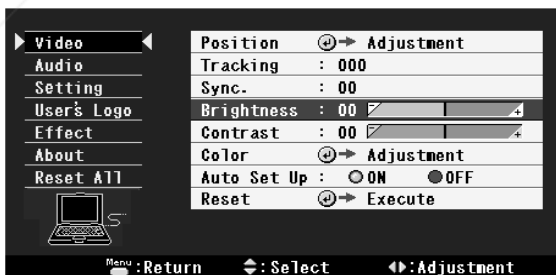

**Note:** The options available in some submenus vary, depending on whether the current image source is the computer or a video source.

4. Press the up or down buttons (operation panel) or the top or bottom of the pointer button (remote) to scroll through the menu choices.
5. Press either the left or right buttons (operation panel) or the right or left sides of the pointer button (remote) to change a setting on one of the submenus.
6. When you finish changing settings, press the Menu button to go back to the Main menu. Your changes are saved automatically.

## Video Menu (Image source = Computer)

The Video menu enables you to make adjustments to the projected image. The following options are available when the image source is Computer.

- ◆ **Note:** *The computer must be connected and operating, and the image source on the projector must be set to Computer for you to access these menu options.*

Menu item	Description
Position	Select this item and then press either multi-purpose button(remote) or the <Enter> button(operation panel) to enter the screen position adjustment mode. While in the screen position adjustment mode, use the pointer button or the <Up>, <Down>, <Left> and <Right> buttons to move the screen position in the corresponding direction. After you finish, press the <Menu> button to return to the Computer Menu.
Tracking	Matches the projector's internal clock to various computer graphic signals. Adjust this setting to remove vertical lines from the image.
Sync	Synchronizes with the tracking signal sent from the computer. Adjust this setting whenever the overall image is fuzzy or to remove streaks from the image.



Discount-Merchants.com (800) 881-8860  
 THE TRUSTED SOURCE FOR PROJECTOR PARTS AND ACCESSORIES

<b>Menu item</b>	<b>Description</b>
Brightness	Lightens or darkens the overall image. Increase brightness to make the image lighter, or decrease it to make the image darker.
Contrast	Adjusts the relative difference between light and dark areas. Increase contrast to make light areas lighter and dark areas darker, or decrease it to lessen the difference between the light areas and dark areas of the image.
Color	Adjusts the color balance of the input source. Select this item and then press either multi-purpose button(remote) or the <Enter> button (operation panel) to enter the color adjustment mode. While in the color adjustment mode, use the pointer button or the <Up> and <Down> buttons to select a color. Next, use the pointer button or <Left> and <Right> buttons to adjust the selected color. Increasing a color's setting makes that color more intense on the screen, while a lower setting makes the color less intense. After you finish, press the <Menu> button to return to the Computer Menu.
Auto Set Up	Pressing AUTO automatically adjusts the computer input signal to the current projector settings. Press the AUTO button while the image fills the entire screen of your computer, like a Windows screen. Certain computer input signals may not be totally compatible with AUTO button settings. In such cases, use the menus to make additional adjustments.
Reset	Returns all Computer Menu items to their factory defaults. Select this item , then press either multi-purpose button(remote) or the <Enter> button (operation panel) to display the confirmation screen. Next, select Yes and press a multi-purpose button(remote) or the <Enter> button (operation panel) to reset the Computer Menu items. If you change your mind, select No and press either multi-purpose button(remote) or the <Enter> button (operation panel) to clear the confirmation screen without changing any settings.



Discount-Merchant.com (800) 281-8860  
 THE TRUSTED SOURCE FOR PROJECTOR PARTS AND ACCESSORIES

---

## Video Menu (Image source = Video)

The Video menu enables you to make adjustments to the projected image. The following options are available when the image source is Video.

- ◆ **Note:** *The video source (such as a VCR or camcorder) must be connected and operating, and the image source on the projector must be set to Video for you to access these menu options.*

Menu item	Description
Brightness	Lightens or darkens the overall image. Increase brightness to make the image lighter, or decrease it to make the image darker.
Contrast	Adjusts the relative difference between light and dark areas. Increase contrast to make light areas lighter and dark areas darker, or decrease it to lessen the difference between the light areas and dark areas of the image.
Color	Adjusts color density. Increase color density to make colors darker and more opaque, or decrease it to make colors lighter and less opaque.
Tint (NTSC only)	Adjust the red-green balance of the screen. Increase tint to add more green, or decrease it to add more red.
Sharpness	Adjusts screen sharpness. Increase sharpness to make screen images more sharp, or decrease it to make the images less sharp.
Reset	Returns all Video Menu items to their factory defaults. Select this item and then press either multi-purpose button(remote) or the <Enter> button(operation panel) to display the confirmation screen. Next, select Yes and then press a multi-purpose button(remote) or the <Enter> button(operation panel) to reset the Video Menu items. If you change your mind, select No and then press either multi-purpose button(remote) or the <Enter> button(operation panel) to clear the confirmation screen without changing any settings.

---



Discount-Merch.com 1-800-368-3660  
THE TRUSTED SOURCE FOR PROJECTOR ACCESSORIES



---

## Audio Menu

The Audio menu enables you to make adjustments related to audio.

Menu item	Description
Volume	Adjusts the volume level for the speakers and audio-out terminal. Increase the audio volume to raise the volume, or decrease it to lower the volume.
Treble	Adjusts the treble tone of the speakers.
Bass	Adjusts the bass tone of the speakers.
SRS SPACE	Adjusts sound effects. Increasing number, the sound effects gets enhanced.
SRS CENTER	Increasing number, the sound effects gets deeper.
Reset	Returns all Audio menu items to their initial factory defaults. Select this item and then press the <Enter> button (operation panel) or either multi-purpose button (remote) to display the confirmation screen. Next, select Yes and then press the <Enter> button (operation panel) or a multi-purpose button (remote) to reset the Audio menu. If you change your mind, select No and then press a multi- purpose button (remote) or the <Enter> button (operation panel) to clear the confirmation screen without changing any settings.

## Setting Menu

The Setting menu enables you to adjust basic settings that normally do not need changing.

Menu item	Description
Prompt	Temporarily displays a message on the projector screen to identify which source (computer or video) is providing the image.



FixYourDLP.com

Sponsored by

Discount-Merchant.com (800) 281-9860

THE TRUSTED SOURCE FOR PROJECTOR REPAIRS AND ACCESSORIES

<b>Menu item</b>	<b>Description</b>
Color Temp.	Adjusts the whiteness of the screen. Positive color temperature values provide a cold white; negative values provide a warmer white. Press the pointer button(remote) or the <Left> and <Right> buttons(operation panel) to change the value. Press the <Menu> button to clear the setting screen, and return to the Main menu.
Ceiling	Flips the projected image so it looks correct when you're hanging the projector upside-down from the ceiling. Selecting ON turns this feature on, while OFF turns it off (for a normal image).
Rear Proj.	Mirrors the projected image so it looks correct when you're projecting from behind onto a translucent screen. Selecting ON turns mirroring on, while OFF turned it off (for a normal image).
Blank (AV/Mute)	Specifies whether a black screen, a blue screen, or a user logo displays when the screen is blanked. See page 45 and 46 for more information about creating a user logo.
Video Signal	Specifies the input image signal mode. Press either multi-purpose button(remote) or the <Enter> button (operation panel) to display the video signal system window. User can select from AUTO, NTSC, NTSC 4.43, PAL, PALN, PALM, PAL60 and SECAM.
Language	To display the language selection window, press either multi-purpose button(remote) or the <Enter> button (operation panel). Selects the menu language: Japanese, English, French, German, Italian, Spanish and Portuguese.



**Discount-Merchant.com (800) 281-8860**  
**THE TRUSTED SOURCE FOR PROJECTOR LAMPS AND ACCESSORIES**

---

<b>Menu item</b>	<b>Description</b>
Reset	Returns all menu items to their factory defaults. Select this item and then press either multi-purpose button(remote) or the <Enter> button(operation panel) to display the confirmation screen. Next, select Yes and then press a multi-purpose button(remote) or the <Enter> button(operation panel) to reset the Setting menu. If you change your mind, select No and then press either multi-purpose button(remote) or the <Enter> button(operation panel) to clear the confirmation screen without changing any settings.

---



**Discount-Merchant.com (800) 281-8860**  
**THE TRUSTED SOURCE FOR PROJECTOR LAMPS AND ACCESSORIES**

---

## User's Logo Menu

The Use's Logo menu enables you to display a custom logo on the screen.

Follow these steps to capture and store a logo:

1. Display the image (with the projector) you wish to use as a logo.
2. Press the Menu button to open the Menu window.
3. Select the User's Logo menu option by pressing the down arrow button on the operation panel or the pointer button on the remote control. Then press the Enter button (operation panel) to display the User's Logo Setting window.
4. The message, "Do you use this image as a user logo?" appears on the screen. Choose Yes or No by pressing the left or right arrow buttons (operation panel) or pressing left or right on the pointer (remote). Then press Enter.
5. A selection box will appear over the image. To select the portion of the image you wish to use as the logo, use the arrow buttons (operation panel) or the pointer button (remote). Once you have selected the desired area, press the Enter button.
6. The message "Do you use this image?" appears on the screen. Select Yes and press the Enter button. If you want to change the position, select No.

Next, the Zoom rate setting window appears on the screen. Select a rate using the arrow buttons or pointer, then press the Enter button.

8. The message "Do you save this image?" appears on the screen. Select Yes and press the Enter button. If you don't want to save the logo, select No.

- 
- ◆ **Note:** *Saving the logo may take a moment. Do not use the projector or other sources (computer, video, speaker, etc.) while the logo is being saved.*
9. When the message "Saving the user logo is completed" appears on the screen, press the Menu or Enter button to display the Main menu.



**Discount-Merchant.com (800) 281-8860**  
**THE TRUSTED SOURCE FOR PROJECTOR LAMPS AND ACCESSORIES**

---

## Effect Menu

The Effect menu lets you select detailed settings for the effect buttons on the remote control. Also, you can change the cursor speed. Select the item you want to set, then press either multi-purpose button(remote) or the <Enter> button (operation panel) to display the detailed setting window.

Menu item	Description
pointer	Sets the pointer icon and size.
Box	Sets the box color.
Line	Sets the color and width.
Marker	Sets the marker color and width.
Clear	Cancel all effect functions you have previously executed.
Cursor Speed (LMH)	Sets the cursor speed to Low, Middle, or High.
Reset	Returns all effect functions to their factory defaults.



**Discount-Merchant.com (800) 281-8860**  
THE TRUSTED SOURCE FOR PROJECTOR LAMPS AND ACCESSORIES

---

## About Menu

The About menu displays information about your projector. Press either multi-purpose button(remote) or the <Enter> button (operation panel) to display the information.

- When the image source is Computer:

---

Frequency	Displays H/V frequency of the computer.
Resolution	Displays the output resolution of the computer video output.
Refresh Rate	Displays the refresh rate of the computer video output.
Lamp	Displays the number of hours the current projector lamp has been used. The lamp light turns red when the projector lamp is near the end of its normal life. When this happens, replace the projector lamp with a new one as soon as possible.

---

- When the image source is Video:

---

Video Signal	Displays the current video signal.
Lamp	Displays the number of hours the current projector lamp has been used. The lamp light turns red when the projector lamp is near the end of its normal life. When this happens, replace the projector lamp with a new one as soon as possible.

---

## RESET ALL Menu

Selecting the Reset All menu option resets the settings in all menus to their factory defaults.

While executing this command, the menu window disappears from a screen and "RESET ALL" will be flashing on the center of the screen.

Select this item and then press either multi-purpose button(remote) or the <Enter> button(operation panel) to display the confirmation screen.

---

Next, select Yes and then press either multi-purpose button(remote) or the <Enter> button(operation panel) to reset all menu items.

If you change your mind, select No and then press either multi-purpose button(remote) or the <Enter> button(operation panel) to clear the confirmation screen without changing any settings.



**Discount-Merchant.com (800) 281-8860**  
**THE TRUSTED SOURCE FOR PROJECTOR LAMPS AND ACCESSORIES**





**Discount-Merchant.com (800) 281-8860**  
**THE TRUSTED SOURCE FOR PROJECTOR LAMPS AND ACCESSORIES**



# 4

## Maintenance

Your projector needs little maintenance. You should keep the lens clean because any dirt or smears appear on the screen. You also need to periodically clean the air filter at the bottom of the projector.

A clogged air filter can block ventilation needed to cool the projector and keep it from overheating.

The only parts you should replace are the lamp and air filter. If any other part needs replacing, contact your dealer or a qualified service person.

- ◆ ***Warning:*** Before you clean any part of the projector, turn off the projector and unplug the power cord. Never open any cover on the projector, except the lamp and filter covers. Dangerous electrical voltages in the projector can injure you severely. Do not try to service this product yourself, except as specifically explained in this User's Guide. Refer all other servicing to qualified service personnel.



**Discount-Merchant.com (800) 281-8860**  
THE TRUSTED SOURCE FOR PROJECTOR LAMPS AND ACCESSORIES

---

## Cleaning the Lens

Clean the lens whenever you notice dirt or dust on the surface. Wipe the lens surface gently with a soft, dry, lint-free cloth. To remove dirt or stains on the lens, moisten a soft cloth with water and a neutral detergent and gently wipe the lens surface.

## Cleaning the Projector Case

To clean the projector case, first unplug the power cable. To remove dirt or dust, wipe the casing with a soft, dry, lint-free cloth. To remove stubborn dirt or stains, moisten a soft cloth with water and a neutral detergent. Then wipe the casing.

Do not use alcohol, benzene, thinners or other chemical detergents. These can cause the casing to warp.



**Discount-Merchant.com (800) 281-8860**  
**THE TRUSTED SOURCE FOR PROJECTOR LAMPS AND ACCESSORIES**

# Cleaning the Air Filter

Clean the air filter at the bottom of the projector after every 100 hours of use. If it is not cleaned periodically, it can become clogged with dust, preventing proper ventilation. This can cause overheating and damage the projector. To clean the air filter, follow these steps:

1. Turn off the projector and unplug the power cable.
2. Turn the projector on its side so that the handle is on top and you can access the filter easily.

◆ **Note:** *Standing the projector with the handle at the top keeps dust from getting inside the projector housing.*

3. Pull up the filter cover tab to release the filter cover. Remove the cover.

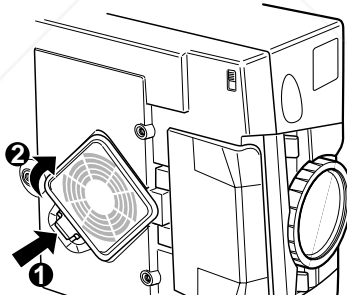

4. The filter is attached to the inside of the filter cover. It is recommended that you use a small vacuum cleaner designed for computers and other office equipment to clean the filter. If you don't have one, use a dry, lint-free cloth.

If the dirt is difficult to remove or if the filter is torn, replace it. Contact your dealer or call EPSON Service Center.

5. Replace the filter cover when you're done.

---

# Replacing the Lamp

The projector lamp typically lasts for about 2000 hours of use. It is time to replace the lamp when:

- The projected image gets darker or starts to deteriorate.
- The projection lamp indicator is flashing orange.
- The message “LAMP REPLACE” appears on the screen when the projector lamp comes on.

Contact your local EPSON dealer for a replacement lamp. Use only replacement lamp part number.(ELPLP06 or ELPLP07)

- ◆ ***Caution:*** *This projector lamp develops high heat and high pressure during use, so the lamp (bulb) ruptures and burns may occur. To avoid serious injury, before attempting to replace the lamp, pull out the power cord plug from the outlet and wait for the lamp (bulb) to cool (wait at least one hour).*

1. Turn off the projector and unplug the power cable.
2. Place the projector on its side with the handle at the top so you can easily access the lamp cover.

- ◆ ***Note:*** *Placing the projector in this position keeps dust from getting inside the projector housing.*



**Discount-Merchant.com (800) 281-8860**  
**THE TRUSTED SOURCE FOR PROJECTOR LAMPS AND ACCESSORIES**

3. Use a screwdriver, coin, or similar object to loosen one retaining screw on the lamp cover. When the screw is loose, lift off the lamp cover. (You cannot remove this screw from the cover.)

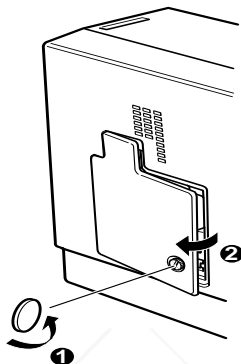

4. Use a screwdriver, coin, or similar object to loosen two screws holding the lamp in position. (You cannot remove these screws.)
5. Lift up the handle and pull out the lamp.

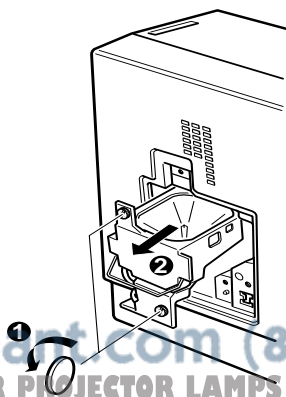

- 
6. Gently insert the new lamp by lowering it into position. Make sure it is inserted securely.
  7. Tighten the screws you loosened in step 4.
  8. Replace the lamp cover and tighten the cover screw. (Make sure the lamp cover is securely fastened. The projector will not run if the lamp cover is open.)



**Discount-Merchant.com (800) 281-8860**  
**THE TRUSTED SOURCE FOR PROJECTOR LAMPS AND ACCESSORIES**



# 5

## Troubleshooting

This chapter describes the problems indicated by the status lights and provides information how to solve problems with the projector. It is divided into the following sections:

- "Problems with the Projector" on page 58 and 59 tells you what to do if any of the projector's warning lights come on.
- "Problems with the Image or Sound" on page 60 and 61 describes what to do if you cannot project an image, if the screen image is not good, or if there is no sound.

If you have a problem, check the appropriate section and follow all suggestions that apply to your problem. If none of the suggestions solve the problem, call your dealer or contact EPSON Service Centre.



**Discount-Merchant.com (800) 281-8860**  
THE TRUSTED SOURCE FOR PROJECTOR LAMPS AND ACCESSORIES



# Problems with the Projector

If you have problems with the projector, first turn it off and unplug it. Then plug the power cord back in and turn on the projector. If this does not solve the problem, check the warning lights at the top of the projector. These lights alert you to problems with projector operation.

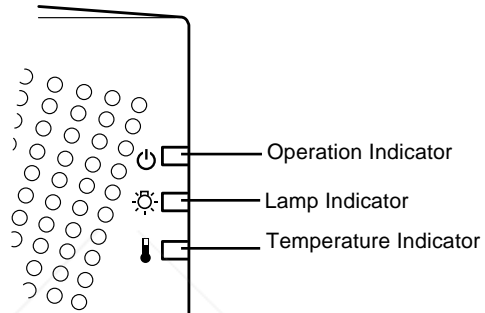

See the following pages for information on what to do when you see these warning lights or encounter other specific problems with the projector.

**The operation indicator is flashing orange and you cannot turn on the projector.**

The lamp is cooling down. Wait until the light turns off and then turn on the projector.

**The operation indicator does not come on.**

Turn off the projector, check that the power cable is connected securely both at the power outlet and the projector, and press the Power button again.

**Projected images get darker or start to deteriorate, or the lamp indicator is red.**

Replace the projector lamp as described on page 54.

---

❑ **The temperature indicator is red.**

The projector is overheating, which turns the lamp off automatically. Let the projector cool for a few minutes, then turn it back on. Make sure nothing is blocking the ventilation vents.

The air filter may be clogged. Clean it as described in Chapter 4 and then let the projector cool for a while.

If the projector continues to overheat after you clean the air filter, the problem may be caused by damage to the cooling fan or internal circuits. Contact a qualified service person.

- ◆ **Warning:** *Except as specifically explained in this User's Guide, do not attempt to service this product yourself.*



**Discount-Merchant.com (800) 281-8860**  
**THE TRUSTED SOURCE FOR PROJECTOR LAMPS AND ACCESSORIES**

---

# Problems with the Image or Sound

**An image does not appear on the screen.**

Check that the power light is on and the lens cover is off. Also make sure the cables are installed correctly, as described in Chapter 1.

The correct image source may not be selected. Press the Source button on the remote control or the operation panel to choose another image source.

**Only part of the computer image is displayed.**

If the computer's output resolution setting is higher than  $1024 \times 768$ , the projector resizes the image. If the computer output is not compatible with this resizing, choose a different display setting on the computer. In Windows 3.x, use Windows Setup in the Main program group. For a Macintosh, choose Operation Panels under the Apple menu and then choose Monitors. In the Monitors screen, choose Options and make sure Macintosh Hi-Res Display or another  $1024 \times 768$  display is selected. For supported display settings, see "Supported Monitor Displays (EMP-7500)" on page 65 or "Supported Monitor Displays (EMP-5550/5500)" on page 66.

You also may need to modify existing presentation files if you created them for a different resolution. See your software manual for specific information.

**The message NO SIGNAL is displayed.**

An image source not connected to the projector is selected, the signal is not being output from the computer, or the signal is not reaching the projector. Make sure the connectors are securely attached to both the projector and the image source. Then check that the image source is selected correctly. When NO SIGNAL is displayed, you cannot access the source (computer/video) menu.

---

**A blank screen is displayed.**

The computer signal cannot be interpreted by the projector. Verify the display format (see page 65 or 66). When you see a blank screen, you cannot access the projector menus.

**The image or parts of the image are blurred or not in focus.**

Adjust the Brightness and Contrast settings on the Video main menu. If you're viewing a computer image, also try adjusting the Tracking and Sync buttons on the projector's operation panel.

There may be dirt or smears on the lens. Clean the lens as described in Chapter 4, "Maintenance."

**The colors of the image are not right.**

The color balance may be incorrect. If you're displaying a computer image, adjust the red, green, and blue settings in the Video menu. If you're displaying video, adjust the Color and Tint (NTSC only) settings on the Video menu.

**There is no sound.**

First check that the volume setting is not turned all the way down and that the A/V cable is securely attached to both the projector and the audio source.

The wrong source is selected. Press either the Computer or Video button on the remote control or operation panel to select the proper source.



**Discount-Merchant.com (800) 281-8860**  
**THE TRUSTED SOURCE FOR PROJECTOR LAMPS AND ACCESSORIES**



**Discount-Merchant.com (800) 281-8860**  
**THE TRUSTED SOURCE FOR PROJECTOR LAMP AND ACCESSORIES**



6

# Technical Specifications

---

## General

---

Type of display	Poly-silicon TFT
Size of liquid crystal panels	0.9 inches (22.9 mm)
Resolution	EMP-5550/5500 : 800(h) × 600(v) pixels EMP-7500 : 1024(h) × 768(v) pixels
Screen size	19 - 230 inch (Tele angle) 25 - 300 inch (Wide angle)
Projection distance	3.28 - 53.46 feet (1.0 - 16.3 meters)
Remote control range	33 feet (10 meters)
Internal speaker system	1W + 1W stereo
Optical aspect ratio	4 : 3 (horizontal : vertical)
Zoom ratio	1:1.3

---

---

## Projector Lamp

---

Type	UHE Lamp (Ultra High Efficiency Lamp)
Power	120 W
Part number	EMP-7500/5500 : ELPLP06 EMP-5550 : ELPLP07

---



**Discount-Merchant.com (800) 281-8860**

**THE TRUSTED SOURCE FOR PROJECTOR LAMPS AND ACCESSORIES**

---

## Mechanical

---

Height	3.6 inches (93 mm) Maximum dimension
--------	---

---



---

**Mechanical**

---

Width	9.3 inches (238.5 mm) Maximum dimension
Depth	13.6 inches (346 mm) Maximum dimension
Weight	9.4 lb (4.2 kg)

---

---

**Electrical**

---

Voltage	100 - 120 VAC and 200 - 240 VAC $\pm$ 10%
Rated frequency	50/60 Hz
Power supply	100 - 120 V, approximately 2.2 A 50/60 Hz 200 - 240 V, approximately 1.0 A 50/60 Hz

---

---

**Environmental**

---

Temperature	Operation: 41 - 95° F (5 - 35° C), non-condensing  Storage: 14 - 140° F (-10 - 60° C), non-condensing
Humidity	Operation: 20 - 80%, non-condensing  Storage: 10- 90%, non-condensing

---



**Discount-Merchant.com (800) 281-8860**  
**THE TRUSTED SOURCE FOR PROJECTOR LAMPS AND ACCESSORIES**

# Supported Monitor Displays (EMP-7500)

The projector displays images at a resolution of  $1024 \times 768$  pixels. To display a higher resolution image ( $1280 \times 1024$  mode), the projector compresses the image to  $1024 \times 768$  pixels.

The following table lists the display formats supported by the projector:

Format	Pixels	Resize display	Window display
PC98	640 x 400	960 x 600	640 x 400
VGA 60	640 x 480	960 x 720	640 x 480
VGAEGA	640 x 350	960 x 525	640 x 350
VESA 72/75/85	640 x 480	960 x 720	640 x 480
SVGA 56/60/72/75/85	800 x 600	1000 x 750	800 x 600
XGA 60/70/75/85	1024 x 768	1024 x 768	1024 x 768
SXGA 70/75/85	1152 x 864	1008 x 756	1152 x 864
SXGA 60/75	1280 x 1024	960 x 768	1280 x 1024
Mac 13"	640 x 480	960 x 720	640 x 480
Mac 16"	832 x 624	832 x 624	832 x 624
Mac 19"	1024 x 768	1024 x 768	1024 x 768
Mac 21"	1152 x 870	1008 x 762	1152 x 870
TV(NTSC)	640 x 480	1024 x 768	←
TV(PAL, SECAM)	768 x 576	1024 x 768	←

The frequencies of some computers may not allow the image to be displayed correctly.



**Discount-Merchant.com (800) 281-8860**  
THE TRUSTED SOURCE FOR PROJECTOR LAMPS AND ACCESSORIES



# Supported Monitor Displays (EMP-5550/5500)

The projector displays images at a resolution of  $800 \times 600$  pixels. To display a higher resolution image ( $1024 \times 768$  mode), the projector compresses the image to  $800 \times 600$  pixels.

The following table lists the display formats supported by the projector:

Format	Pixels	Resize display	Window display
PC98	640 x 400	800 x 500	640 x 400
VGA 60	640 x 480	800 x 600	640 x 480
VGAEGA	640 x 350	768 x 420	640 x 350
VESA 72/75/85	640 x 480	800 x 600	640 x 480
SVGA 56/60/72/75/85	800 x 600	800 x 600	800 x 600
XGA 60/70/75/85	1024 x 768	768 x 576	1024 x 768
SXGA 70/75	1152 x 864	768 x 576	1152 x 864
Mac 13"	640 x 480	800 x 600	640 x 480
Mac 16"	832 x 624	800 x 600	832 x 624
Mac 19"	1024 x 768	768 x 576	1024 x 768
Mac 21"	1152 x 870	768 x 580	1152 x 870
TV(NTSC)	640 x 480	800 x 600	←
TV(PAL, SECAM)	768 x 576	800 x 600	←

The frequencies of some computers may not allow the image to be displayed correctly.

**Note:** *The frequencies of some computers may not allow the image to be displayed correctly.*

**Note:** *This projector is compatible with DDC-capable graphic sub-systems and boards only.*



FixYourDLP.com  
Sponsor

DiscountMerchant.com (800) 291-2860  
THE TRUSTED SOURCE FOR PROJECTOR LAMPS AND ACCESSORIES

---

# Monitor and Computer connector pin assignments

The Monitor and Computer connectors are female video RGB, 15-pin micro-D-style connectors. The pin assignments are:

Input pin	Signal
1	Red analogue input
2	Green analogue input
3	Blue analogue input
4	GND
5	GND
6	Red GND
7	Green GND
8	Blue GND
9	Reserved
10	Sync GND
11	GND
12	SDA (DDC)
13	Horizontal sync/composite sync input
14	Vertical sync input
15	SCL (DDC)



**Discount-Merchant.com (800) 281-8860**  
THE TRUSTED SOURCE FOR PROJECTOR LAMPS AND ACCESSORIES



**Discount-Merchant.com (800) 281-8860**  
**THE TRUSTED SOURCE FOR PROJECTOR LAMP AND ACCESSORIES**

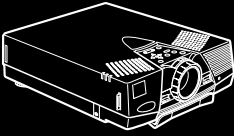

# Glossary

**Brightness.** The balance of light and dark shades in an image.

**Composite video.** A type of video signal that encodes colours, luminance and synchronization information so it can be carried in one signal.

**Contrast.** A measure of the luminance differences between the highlights and shadows of an image. In a high-contrast image, light areas are very bright and dark areas are very dark.

**NTSC.** A 525-line video broadcast format developed by the National Television Standards Committee. NTSC is widely used in North America, Mexico and Japan.

**PAL (Phase Alternation by Line).** A 625-line video broadcast format used in Western Europe, India, China, Australia, New Zealand and parts of Africa.

**Resolution.** A measure of the amount of detail contained in an image. Resolution can be measured in dots per inch or in pixels. Image sharpness and clarity improve as resolution increases.

**RGB.** Red Green Blue

**S-Video.** A type of video signal which transmits luminance and colour separately.

**SECAM (Système Electronique pour Couleur Avec Mémoire).** A 625-line TV system used in France, Eastern Europe, Russia and parts of Africa.



FixYourDLP.com

Sponsored by DLP

Discount-Merchant.com (800) 281-8860

THE TRUSTED SOURCE FOR PROJECTOR LAMPS AND ACCESSORIES

---

**Serial.** A type of communication interface that transmits data over a single wire.

**Sleep mode.** The power cable is connected but the projector is switched off. In this mode the power LED lights up orange. If the projector is not used for 30 minutes the lamp switches itself off and after 30 seconds the projector goes into sleep mode.



**Discount-Merchant.com (800) 281-8860**  
**THE TRUSTED SOURCE FOR PROJECTOR LAMPS AND ACCESSORIES**



# Index

## A

A/V cable 2  
About Menu 48  
Audio cable 2  
Audio Menu 42  
Auto 40  
Auto Set Up 40  
AV/Mute 30, 32  
AVTSS vii

## B

Bass 42  
BIS CUIT viii  
Blank 43  
bottom multi-purpose button 29  
Brightness 40, 69

## C

Ceiling 43  
Cleaning the Air Filter 53  
Color 40  
Color Temp. 43  
Composite video 69  
Computer cable 2

Contrast 40, 69  
Custom 30

## E

Effect Menu 47  
Effects buttons 30  
ELP LINK III viii  
Enter button 31

## F

FAQ's xv  
focus ring 22, 25  
Focusing 25  
foot adjust lever 26  
Freeze 30  
Frequency 48

## G

Glossary 69

## I

Installation xi

## L

Lamp 48  
Lamp Indicator 33, 34  
Language 43

## M

Main Menu 36  
Maintenance xi, 51  
Monitor Displays 65, 66  
Mouse cable 2

## N

NTSC viii, 69

## O

Operation Indicator 33  
operation panel 22  
Optional Accessories x  
Options Menu 42

## P

PA System 18  
PA system 1  
PAL viii, 69  
pin assignments 67  
pointer button 29  
Position 39  
Positioning the Screen Image 25  
Projector 2  
Projector Menus 35  
Projector Status Indicators 33

Prompt 42  
 FixYourDLP.com  
Sponsored by DM

## R

RCA/3.5 mm cable 19  
rear feet clockwise 26  
Rear Proj. 43

Refresh Rate 48  
Remote control ix  
remote control 28  
Replacing the Lamp 54  
Reset 40  
RESET ALL Menu 48  
Resize Button 27  
Resize button 27  
Resolution 48, 69  
RGB 69

## S

Safety Instructions xii  
SECAM viii, 69  
Serial 70  
Sharpness 41  
Sleep Mode 24  
Sleep mode 70  
SRS 3D sound vii  
SRS CENTER 42  
SRS SPACE 42  
sub-menu 38  
S-Video viii, 69  
S-Video cable 3  
SXGA viii  
Sync 39

## T

Technical Specifications xi  
Temperature Indicator 33  
Tint 41  
top multi-purpose button 29  
Tracking 39  
Treble 42  
Troubleshooting xi, 57

---

true XGA vii

## **V**

VGA viii

video source vii

Volume 42

## **W**

World Wide Web xv

## **X**

XGA viii

## **Z**

Zoom ratio 63

zoom ring 22, 25



**Discount-Merchant.com (800) 281-8860**  
**THE TRUSTED SOURCE FOR PROJECTOR LAMPS AND ACCESSORIES**





**Discount-Merchant.com (800) 281-8860**  
**THE TRUSTED SOURCE FOR PROJECTOR LAMPS AND ACCESSORIES**



**Discount-Merchant.com (800) 281-8860**  
**THE TRUSTED SOURCE FOR PROJECTOR LAMPS AND ACCESSORIES**



**Discount-Merchant.com (800) 281-8860**  
**THE TRUSTED SOURCE FOR PROJECTOR LAMPS AND ACCESSORIES**

## After sales service contact addresses

EPSON (UK) LIMITED  
(01442) 261144  
Campus 100  
Maylands Avenue  
Hemel Hempstead  
Herts. HP2 7TJ  
United Kingdom

EPSON HONG KONG LIMITED  
(852) 2585 4300  
Rooms 4706-10 47 th Floor  
China Resources Building  
26 Harbour Road Wanchai  
Hong Kong

EPSON FRANCE S.A.  
0140873873  
68 Bis Rue Marjolin  
92305 Levallois Perret  
France

EPSON ELECTRONICS TRADING  
LTD. (TAIWAN BRANCH)  
(02) 7177360  
10F, No. 287 Nanking E.Road, Sec.3,  
Taipei, Taiwan R.O.C.

EPSON DEUTSCHLAND GMBH  
0211/56030  
Zülpicher Straße 6,  
40549 Düsseldorf  
F.R. Germany

EPSON SINGAPORE PTE LTD  
337-7911  
No.1, Temasek Avenue  
#36-00, Millenia Tower  
Singapore 039192  
Singapore

EPSON ITALIA S.P.A  
0039-2-26233-1  
V.le Casiraghi 427  
20099 Sesto S. Giovanni (MI)  
Italy

EPSON AUSTRALIA PTY  
LIMITED  
(02) 415 9000  
70 Gibbes Street  
Chatswood NSW 2067  
Australia

EPSON IBERICA, S.A.  
(93) 5821500  
Av. Roma, 18-26  
08290 Cerdanyola del Vallès  
(Barcelona)  
Spain

**EPSON®**



**Discount-Merchant.com (800) 281-8860**  
**THE TRUSTED SOURCE FOR PROJECTOR LAMPS AND ACCESSORIES**



# Disclaimer

This user manual is provided as a free service by FixYourDLP.com. FixYourDLP is in no way responsible for the content of this manual, nor do we guarantee its accuracy. FixYourDLP does not make any claim of copyright and all copyrights remain the property of their respective owners.

About FixYourDLP.com

FixYourDLP.com (<http://www.fixyourdpl.com>) is the World's #1 resource for media product news, reviews, do-it-yourself guides, and manuals.

Informational Blog: <http://www.fixyourdpl.com>

Video Guides: <http://www.fixyourdpl.com/guides>

User Forums: <http://www.fixyourdpl.com/forum>

FixYourDLP's Fight Against Counterfeit Lamps:

<http://www.fixyourdpl.com/counterfeits>

## Sponsors:

RecycleYourLamp.org – Free lamp recycling services for used lamps:

<http://www.recycleyourlamp.org>

Lamp Research - The trusted 3rd party lamp research company:

<http://www.lampresearch.com>

Discount-Merchant.com – The worlds largest lamp distributor:

<http://www.discount-merchant.com>



**FixYourDLP.com**

Sponsored by 